



# RBFS User Guides

Version \_24.9.1.1, 30 Jan 2025

# Table of Contents

1. Overview Guides .....	1
1.1. RBFS CLI Overview .....	1
1.1.1. RBFS Command Line Interface .....	1
1.2. BDS Overview .....	21
1.2.1. BDS Overview .....	21
1.2.2. BDS Operational Commands .....	22
2. Routing .....	28
2.1. RIB .....	28
2.1.1. RIB Overview .....	28
2.1.2. RIB Operational commands .....	33
2.2. Route Leaking .....	39
2.2.1. Route Leaking Overview .....	40
2.2.2. Route Leaking Configuration .....	41
2.2.3. Route Leaking Operational Commands .....	43
2.3. BGP .....	47
2.3.1. BGP Overview .....	47
2.3.2. BGP Configuration .....	54
2.3.3. BGP Operational Commands .....	78
2.4. BGP FlowSpec .....	94
2.4.1. BGP FlowSpec Overview .....	94
2.4.2. BGP FlowSpec Configuration .....	99
2.4.3. BGP FlowSpec Operational Commands .....	101
2.5. BGP RPKI-RTR Route Validation .....	118
2.5.1. BGP RPKI-RTR Prefix Validation Overview .....	118
2.5.2. BGP Prefix Validation Using RPKI-RTR Configuration .....	123
2.5.3. BGP Route Validation with RPKI-RTR Operational Commands .....	127
2.6. IS-IS .....	132
2.6.1. IS-IS Overview .....	132
2.6.2. IS-IS Configuration .....	132
2.6.3. IS-IS Operational Commands .....	146
2.7. OSPFv2/v3 .....	163
2.7.1. OSPF Overview .....	163

2.7.2. OSPF Configuration .....	167
2.7.3. OSPF Operational Commands .....	185
2.8. LDP .....	207
2.8.1. LDP Overview .....	207
2.8.2. LDP Configuration .....	211
2.8.3. LDP Operational Commands .....	220
2.9. Policy .....	233
2.9.1. Policy Overview .....	233
2.9.2. Policy Configuration .....	252
2.9.3. Policy Operational Commands .....	275
2.10. Static Routing .....	276
2.10.1. Static Routing Overview .....	276
2.10.2. Static Routing Configuration .....	276
2.10.3. Static Routing Operational Commands .....	281
3. Layer 2 Services .....	284
3.1. L2X .....	284
3.1.1. L2X Overview .....	284
3.1.2. L2X Configuration .....	288
3.1.3. L2X Operational Commands .....	297
3.2. EVPN-VPWS .....	303
3.2.1. EVPN-VPWS Overview .....	303
3.2.2. EVPN VPWS Configuration .....	306
3.2.3. EVPN VPWS Operational Commands .....	314
3.3. BGP-signaled L2VPN .....	325
3.3.1. BGP-signaled L2VPN Overview .....	325
3.3.2. Configuring BGP-signaled L2VPN .....	328
3.3.3. BGP L2VPN Operational Commands .....	336
4. Layer 3 Services .....	347
4.1. L3VPN .....	347
4.1.1. L3VPN Overview .....	347
4.1.2. L3VPN Configuration .....	349
4.1.3. L3VPN Operational Commands .....	363
5. Subscriber Management .....	375
5.1. Subscriber Management .....	375

5.1.1. Subscriber Management Overview .....	375
5.1.2. Subscriber Management Configuration Overview .....	404
5.1.3. Operations .....	477
5.1.4. Supported Standards .....	495
5.2. RBFS RADIUS Services .....	497
5.2.1. RADIUS Services Overview .....	497
5.2.2. RADIUS Service Solution Overview .....	500
5.2.3. RADIUS Control .....	502
5.2.4. RADIUS Accounting .....	532
5.2.5. RADIUS Counters .....	535
5.2.6. RADIUS Accounting Adjustment Configuration .....	542
5.2.7. RADIUS Redundancy .....	544
5.2.8. Test AAA .....	544
5.2.9. Appendix A - RADIUS Dictionary .....	549
5.2.10. Appendix B - RADIUS Standard Attributes Supported .....	551
5.2.11. Appendix C - Access Deployments .....	572
5.3. RBFS Carrier-Grade Network Address Translation .....	573
5.3.1. RBFS Carrier-Grade Network Address Translation Overview .....	573
5.3.2. Carrier-Grade NAT Configuration .....	580
5.3.3. Carrier Grade NAT Operational Commands .....	596
5.4. RBFS HTTP Redirect Service .....	600
5.4.1. RBFS HTTP Redirect Service Overview .....	600
5.4.2. HTTP Redirect Service Configuration .....	603
5.5. RBFS Subscriber Filters .....	604
5.5.1. RBFS Subscriber Filters Overview .....	604
5.5.2. Subscriber Filters Configuration .....	605
5.5.3. Subscriber Filters Operational Commands .....	610
5.6. Lawful Interception .....	611
5.6.1. Lawful Interception Overview .....	611
5.6.2. LI Encapsulation .....	614
5.6.3. LIX1 Configuration .....	615
5.6.4. Enabling Lawful Interception .....	617
5.7. L2BSA .....	620
5.7.1. L2BSA Overview .....	620

5.7.2. L2BSA Configuration .....	624
5.7.3. L2BSA Operational Commands .....	626
5.7.4. L2BSA Operational State API .....	627
5.8. Redundancy .....	634
5.8.1. RBFS Redundancy for Subscriber Groups .....	634
5.8.2. Deploy RBFS in Redundancy Mode .....	644
5.8.3. RBFS Redundancy Operational Commands .....	650
6. Forwarding .....	654
6.1. Interfaces .....	654
6.1.1. Interfaces Overview .....	654
6.1.2. Interfaces Configuration .....	674
6.1.3. Interfaces Operational Commands .....	691
6.2. ARP/ND .....	702
6.2.1. ARP/ND Overview .....	702
6.2.2. ARP/ND Configuration .....	703
6.2.3. ARP/ND Operational Commands .....	706
6.3. ACLs .....	709
6.3.1. ACL Overview .....	709
6.3.2. ACL Configuration .....	711
6.3.3. ACL Operational Commands .....	720
6.4. Port Mirroring .....	727
6.4.1. Port Mirroring Overview .....	727
6.4.2. Port Mirroring Configuration .....	728
6.4.3. Port Mirroring Operational Commands .....	730
6.5. OAM Support .....	731
6.5.1. OAM Overview .....	731
6.5.2. OAM Configuration .....	731
6.6. LAG .....	739
6.6.1. LAG Overview .....	739
6.6.2. LAG Configuration .....	741
6.6.3. LAG Operational Commands .....	746
6.7. HQoS .....	750
6.7.1. Hierarchical Quality of Service (HQoS) Overview .....	751
7. Queueing .....	760

8. Queue-Group .....	762
9. Scheduler .....	763
10. Shaper .....	773
10.1. Low-rate Shaping .....	773
11. Scheduler Mapping .....	774
12. Remarking .....	775
13. Multi-level H-QoS : Level-1 to Level-5 .....	781
13.7. HQoS Configuration .....	785
13.8. Configuring QoS Profiles .....	789
13.8.1. L2 ACL Priority Bit Egress Classifier Configuration .....	798
13.8.2. Policer Configuration .....	800
13.8.3. Class-Policer-Map Configuration .....	802
13.8.4. Queue Configuration .....	804
13.8.5. Queue-Group Configuration .....	805
13.8.6. Scheduler Configuration .....	808
13.8.7. Shaper Configuration .....	809
13.8.8. Scheduler-Map Configuration .....	811
13.8.9. HQoS Show Running-Configuration .....	825
13.8.10. HQoS Operational Commands .....	831
13.9. LLDP .....	844
13.9.1. LLDP Overview .....	844
13.9.2. LLDP Configuration .....	846
13.9.3. LLDP Operational Commands .....	849
14. Multicast .....	853
14.1. IGMP .....	853
14.1.1. IGMP Overview .....	853
14.1.2. IGMP Configuration .....	854
14.1.3. IGMP Operational Commands .....	862
14.2. PIM .....	867
14.2.1. PIM Overview .....	868
14.2.2. PIM Configuration .....	868
14.2.3. PIM Operational Commands .....	873
14.3. Multicast VPN .....	884
14.3.1. MVPN Overview .....	884

14.3.2. MVPN Configuration .....	885
14.3.3. MVPN Operational Commands .....	890
15. Security .....	893
15.1. Securing Management Plane .....	893
15.1.1. Securing the Management Plane Overview .....	893
15.1.2. RtBrick Token .....	894
15.1.3. Role Based Access Control (RBAC) .....	900
15.1.4. SSH with TACACS+ .....	904
15.2. Securing Control Plane .....	911
15.2.1. Securing the Control Plane Overview .....	911
15.2.2. Control Plane Security Configuration .....	916
15.2.3. Control Plane Security Operational Commands .....	925
15.3. Local User Management .....	930
15.3.1. Local User Management Overview .....	930
15.3.2. Local user management Configuration .....	931
15.4. sFlow .....	943
15.4.1. RBFS sFlow Technology .....	943
15.4.2. sFlow Configuration .....	946
15.4.3. sFlow Operational Commands .....	954
16. Telemetry .....	957
16.1. TSDB .....	957
16.1.1. Prometheus Time Series Database (TSDB) Integration Overview .....	957
16.1.2. TSDB Configuration .....	962
16.1.3. Installation .....	977
16.2. Resmon .....	977
16.2.1. Resource Monitoring (resmon) Overview .....	977
16.2.2. Resmon Configuration .....	986
16.2.3. Resmon Operational Commands .....	987
16.3. SNMP .....	997
16.3.1. SNMP Overview .....	997
16.3.2. SNMP Configuration .....	999
17. Infrastructure .....	1008
17.1. NTP .....	1008
17.1.1. NTP Overview .....	1008

17.1.2. NTP Configuration .....	1008
17.1.3. NTP Operational Commands .....	1010
17.2. Logging .....	1012
17.2.1. Logging Overview .....	1012
17.2.2. Logging Configuration .....	1019
17.2.3. Logging Operational Commands .....	1027
17.2.4. RBFS Log Reference .....	1039
17.3. LED Control .....	1201
17.3.1. LED Overview .....	1201
17.3.2. LED Definitions .....	1202
17.4. IPMI .....	1218
17.4.1. IPMI Overview .....	1218
17.4.2. IPMI Configuration .....	1219
17.4.3. IPMI Operational Commands .....	1221
17.5. Inband Management .....	1223
17.5.1. In-band Management Overview .....	1223
17.5.2. In-band Management Configuration .....	1224
17.5.3. In-Band Management Operational Commands .....	1232
17.6. DHCP Relay/Proxy .....	1233
17.6.1. DHCP Relay Overview .....	1233
17.6.2. DHCP Relay Configuration .....	1236
17.6.3. DHCP Relay Operational Commands .....	1239



# 1. Overview Guides

## 1.1. RBFS CLI Overview

### 1.1.1. RBFS Command Line Interface

#### RBFS CLI Overview

RBFS command line interface is a primary user interface that enables you to interact with RBFS for monitoring, configuring, debugging, and maintaining the system. RBFS command line interface, that runs on top of the Ubuntu shell, provides a rich set of commands which allow you to execute various operations on the system.

RBFS CLI commands are organized in hierarchies based on their functionalities. Commands, which are used to execute the same type of functions, have the same hierarchy. For example, to display information, you can use commands that start with 'show'. **Delete** command, in RBFS, is used to remove an existing configuration.

The RBFS command-line interface has three modes: Configuration mode, Operation mode, and Debug mode.

**Operational mode:** This is the default mode of RBFS command line interface. Operational mode allows you to execute the operational commands such as show commands to view or monitor various system configuration and its current state.

**Configuration mode:** Configuration mode allows to execute various configurations for services or features. It also allows you to view the information for the existing configurations.

**Debug mode:** It allows you to execute troubleshooting or debugging operations in the RBFS system.

#### Using the CLI

The following are some of the utilities which help you working with the CLI faster and easier.

#### Complete Partially Typed Commands:

You can press **Tab** key to complete a partially typed command. It helps you work with commands faster.

### Command Options and Description:

If you do not know the options available for a command and the purposes of the options, you can enter the question mark symbol (?). It displays all the available command options and descriptions for that commands.

In any of the modes, if you type the question mark symbol (?), the CLI displays a set of commands which can be executed in that particular mode.

When you execute configurations through CtrlD, and then with the Command Line Interface, it results in error when you commit the configuration through the CLI. The reason is that CtrlD directly interacts with the backend applications (BDS and CONFD) and these changes are not synced with the CLI.

### Launching the RBFS CLI

The following example shows how to start the RBFS CLI.

```
supervisor@rtbrick>LEAF01:~$ cli
supervisor@rtbrick>LEAF01: op>
```



'op>' shows you are in operational mode.

### CLI Prompt

The RBFS CLI prompt reflects the static hostname and host OS hostname. In RBFS, the static hostname is the container name and the dynamic hostname is derived from DHCP.

The format of the RBFS CLI prompt is as follows:

`<username> @ <static_hostname> > <hostname.host-os>: <mode>`

Example:

```
supervisor@rtbrick>LEAF01: op>
```

## Switching CLI Modes

RBFS CLI has three modes: Configuration mode, Operation mode, and Debug mode.

You can enter `switch-mode` command to change the CLI mode.

For example, enter `switch-mode config` to switch to configuration mode.

The following example shows how to switch between modes.

```
supervisor@rtbrick>LEAF01: op> switch-mode
config          Enter a given mode
debug          Enter a given mode
operation       Enter a given mode
```

The following example shows how to switch from the `operation` mode to the `config` mode.

```
supervisor@rtbrick>LEAF01: op> switch-mode config
supervisor@rtbrick>LEAF01: cfg>
```

## Turning Paging On/Off

To turn the paging on or off, use the following command:

### `paging [on | off]`

- `off` - Pagination will be turned off for the commands that span more than screen length
- `on` - Pagination will be turned on for the commands that span more than screen length

Example:

```
supervisor@rtbrick>LEAF01: cfg> paging on
```

## Turning On or Off CLI Colors

To enable or disable the colors in the CLI output, use the following command:

### `color [on | off]`

Example:

```
supervisor@rtbrick>LEAF01: cfg> color on
```

## Accessing CLI Logs

RBFS supports sending command history log messages to Graylog, a log management software that enables real-time analysis of log messages.

The command history logs help you to understand which user has executed a specific command across multiple CLI sessions.

The log format for CLI command history logs is: *User '%s' executed command '%s'*.

System logging is implemented for RESTCONF.



For RESTCONF error logs, do not set the log level to 'info'. If you set the log level to **info**, logs are generated for all the **restconfd** requests.

## Basic CLI Features

### Viewing CLI Tree

The **show cli tree** command displays all RBFS CLI commands and command options that exist.

- **show cli tree**: This command provides you the list of all RBFS CLI commands and options that are available.
- **show cli tree detail**: The detail option for the command displays additional information such as minimum and maximum values allowed.

### Viewing Command History

The **history** command enables you to view the previously executed commands. You can execute the command in any of the CLI modes.

#### **history**

Example:

```
supervisor@rtbrick>LEAF01: op> history
show config set
exit
show config set
load config test.json
load config obj.json
show config set
exit
show config set
load config test.json
switch-mode config
load config test.json
load config obj.json
exit
switch-mode config
show config set
load config test.json
load config obj
load config obj.json
exit
show config set
load config obj.json
load config test.json
exit
show bd running-status
load config test.json
show config set
exit
show bd running-status
exi
show datastore confd table test index index2
exit
```

## Setting Configuration Parameters

The **set** command is used to configure parameters.

```
supervisor@rtbrick: cfg> set system ntp server MyNTPServer ipv4-address 10.1.1.100
```

## Deleting Configuration Parameters

The **delete** command is used to remove existing configuration parameters.

```
supervisor@rtbrick: cfg> delete system ntp server MyNTPServer ipv4-address
10.1.1.100
```

## Viewing Core Dump Files

When a router crashes, it is useful to obtain a complete copy of the memory image, also known as core dump, to identify the cause of the crash.

The `show core-dump stack-trace` command displays core dump data generated by the system. It includes information such as Core Dump File Name, Process Name/ID, Time of Core Dump, Core Dump Size, Signal Information, Process State, and so on.

You can use the command in the following ways:

- `show core-dump` lists the core dump files.
- `show core-dump stack-trace` displays all the stack traces (list of the function calls) for all valid core files.
- `show core-dump stack-trace <file-name>` displays the stack traces for a specified file.
- `show core-dump stack-trace <file-name> per-thread` displays stack trace for all threads for the specified file.
- Use the `clear core-dump` to clear output populated.

## Viewing Hardware Resource Usage Limit Information

In RBFS, you can view the hardware resource usage limit details.

Run the following command:

`show hardware limits`

Example:

```
supervisor@rtbrick>rtbrick.net: op> show hardware limits
Hardware resources:
  Module: fib
    ASIC                : q2c
    Role                 : accessleaf
    Model               : agcva48s
    IPv4 route count    : 1200000
    IPv6 route count    : 250000
  Module: fib
    ASIC                : q2c
    Role                 : accessleaf
    Model               : as7946-74xkb
    IPv4 route count    : 1200000
    IPv6 route count    : 250000
  Module: fib
    ASIC                : q2c
    Role                 : accessleaf
    Model               : as7946-30xb
    IPv4 route count    : 1200000
    IPv6 route count    : 250000
```

```

Module: fib
  ASIC           : q2c
  Role           : accessleaf
  Model          : s9600-72xc
  IPv4 route count : 1200000
  IPv6 route count : 250000
Module: bgp
  ASIC           : q2c
  6PE label      : 2
Module: confd
  ASIC           : q2c
  Max MTU profile : 8
  Max L3 MTU profile : 3
  Max subscriber MTU profile : 6
  Max physical MTU profile : 8
Module: rd
  ASIC           : q2c
  
```

## Rebooting Containers and Hosts

The **reboot** command allows you to restart containers and hosts.

**reboot** <option>

Option	Description
-	Without any option, this command allows you to reboot a container (default). You are prompted to confirm rebooting the container when you enter this command. You must answer yes or no.
container	This command allows you to reboot a container. You are prompted to confirm rebooting the container when you enter this command. You must answer yes or no.
container-and-confirm	This command reboots the container without prompting yes/no.
device	This command allows you to reboot a device. You are prompted to confirm rebooting the device when you enter this command. You must answer yes or no.
device-and-confirm	This command reboots the device without prompting yes/no.

Example:

```
supervisor@rtbrick>LEAF01: cfg> reboot container
```

## Viewing System Version Details

To display the version details of RBFS and its various components, use the **show version** command.

### show version

Example:

```
supervisor@ixr_pel>srv3.nbg1.rtbrick.net: op> show version
UUID           : 2abb4250-2a14-4e5c-84e2-6785eee158f8
Version        : 22.6.0-g4internal.20220620060710+Bfs0000bgpauthlatest.C3abc099d
Role           : spine
Platform       : virtual
Format         : lxd
Build date     : 2022-06-20 06:07:10 UTC
Component      Version
Timestamp      Branch
alertmanager   0.20.1001-
internal.20220613124702+Bdevelopment.... 2022-06-07 20:01:29
development
cligen         0.1.0-
internal.20220613140225+Bdevelopment.C9457c97b 2022-06-07 20:00:33
development
clixon        4.3.1-
internal.20220618124913+Bdevelopment.C85593b60 2022-06-13 11:48:32
development
<...>
```

## Viewing Date and Time

To display system date and time, use the **date** command.

### date

Example:

```
supervisor@rtbrick>LEAF01: op> date
Thu Apr 28 09:56:32 UTC 2022
```

## Viewing the Running configuration

To display the running configurations, enter the **show config** command.

Example:



```
supervisor@rtbrick>LEAF01: cfg> show config
```

## Viewing a Specific Hierarchy

To display the configurations under a specific hierarchy, enter the `show config <hierarchy>` command.

```
supervisor@rtbrick: cfg> show config ?
access          Global access configuration
daemon-options  List of daemon options
global          Global configurations
instance        Network instance configuration
<...>
```

## Viewing Configurations in a Specific Format

The `show config` command displays the current committed configurations of the system. By default, this command displays the configurations in a `json` format.

### `show config <format>`

You can also specify the format explicitly, if needed. The available display formats are:

- **json**: Display configurations in JSON format
- **set**: Display configurations in CLI format (similar to commands executed)
- **netconf**: Display configurations in XML format
- **text**: Display configurations in textual format (similar to YANG definition)

The following example shows how configurations are displayed in the text format.

```
supervisor@rtbrick>LEAF01: op> show config text
daemon-options {
  instance-name *;
  afi *;
  safi *;
  bd-type bgp.appd;
  bd-name bgp.appd.1;
}
daemon-options {
  instance-name *;
  afi *;
  safi *;
  bd-type bgp.iod;
  bd-name bgp.iod.1;
```

```

}
interface {
  name lo-0/0/0;
  unit {
    unit-id 0;
    address {
      ipv4 {
        prefix4 198.51.100.75/24;
      }
      ipv6 {
        prefix6 2001:db8:0:110::/32;
      }
    }
  }
}
}
<...>

```

To view configurations in the set format, use the `show config set` command.

Example:

```

supervisor@rtbrick>LEAF01: cfg> show config set
set interface ifp-0/0/1
set interface ifp-0/0/1 ifp-id 1
set interface ifp-0/0/2
set interface ifp-0/0/2 ifp-id 2
set instance blue
set instance blue protocol bgp address-family ipv4 multicast
set instance blue protocol bgp address-family ipv6 unicast
set instance red
set instance red protocol bgp address-family ipv4 unicast
set instance red protocol bgp address-family ipv6 unicast

```

## Viewing Configuration in a Specified Hierarchy

To view configuration in a specified hierarchy, use the following command:

```

supervisor@rtbrick>LEAF01: cfg> show config set instance red protocol bgp
set instance red protocol bgp address-family ipv4 unicast
set instance red protocol bgp address-family ipv6 unicast

```

## Committing CLI Configurations

To apply the configurations, use the `commit` command.

The following example shows how to commit your changes using the `commit` command.

```

supervisor@rtbrick>LEAF01:~$ cli
supervisor@rtbrick>LEAF01: op> switch-mode config

```

```
supervisor@rtbrick>LEAF01: cfg> <cli command goes here>
supervisor@rtbrick>LEAF01: cfg> commit
```

When you exit CLI configuration with uncommitted changes, a reminder text appears saying that you have changes to commit, as shown in the following example:

```
supervisor@rtbrick>LEAF01: cfg> exit
Uncommitted changes are present
1. Discard the changes and exit
2. Commit the changes and exit
3. Keep the changes and exit [Default behavior]
Enter one of the above choice to proceed :
```

## Viewing Uncommitted Changes

To view the uncommitted changes, use the `show diff` command. The `show diff` command displays output in JSON format, whereas the `show diff set` command displays the output in CLI format.

```
supervisor@rtbrick>LEAF01: cfg> show diff

supervisor@rtbrick>LEAF01: cfg> set interface ifp-0/0/3 ifp-id 3
supervisor@rtbrick>LEAF01: cfg> set interface ifp-0/0/4 ifp-id 4
supervisor@rtbrick>LEAF01: cfg> show diff set
+set interface ifp-0/0/3
+set interface ifp-0/0/3 ifp-id 3
+set interface ifp-0/0/4
+set interface ifp-0/0/4 ifp-id 4
supervisor@rtbrick>LEAF01: cfg> show diff
}
+interface {
+  name ifp-0/0/3;
+  ifp-id 3;
+}
+interface {
+  name ifp-0/0/4;
+  ifp-id 4;
+}
instance {
```

## Adding a Configuration Description

An in-line description or comment can be added to a system configuration to describe it.

**set system config-description** <description>

### Example:

```
supervisor@rtbrick>LEAF01: cfg> set system config-description "This is sample test configuration"
supervisor@rtbrick>LEAF01: cfg> commit
supervisor@rtbrick>LEAF01: cfg> show config
{
  "ietf-restconf:data": {
    "rtbrick-config:system": {
      "config-description": "This is sample test configuration"
    }
  }
}
```

## Saving Configuration

To save configurations, enter the following command:

```
supervisor@rtbrick>LEAF01: cfg> save config my_config.json
```



- Ensure that you use .json at the end of the filename.
- The configuration will be saved to the current working directory of CLI executable.

## Deleting the Entire Running Configuration

The **discard** command is used to discard configuration changes. To delete the entire running configurations (both committed and uncommitted configurations) at a time, use the **discard all** command.

### Example:

```
supervisor@rtbrick>LEAF01: cfg> discard all
```

## Discarding the Uncommitted Configuration

To discard the uncommitted configuration, enter the following command:

```
supervisor@rtbrick>LEAF01: cfg> discard
```

## Viewing the Configuration Differences in the Current and Previous Versions

In RBFS, you can view the configuration differences between the current and the

previous versions.

### **show diff** <number>

```
supervisor@rtbrick>LEAF01: cfg> show diff 2
system {
-   secure-management-status false;
+   secure-management-status true;
}
```

## **Rolling Back to a Previously Committed Configuration**

To rollback to a specific configuration prior to the most recently committed one, use the following command:

### **rollback** <number>

**number**: Specifies the rollback ID. Range: 1 through 49. 0 refers to the active configuration, 1 refers to the most recent previous configuration. Default: 1

For example, to rollback to rollback ID 2, use the following command:

```
supervisor@rtbrick>LEAF01: cfg> rollback 2
```

## **Rolling Back to a Specific Version of Software Configuration**

To rollback to a specific version of the software configuration, use the following command:

### **rollback commit-id** <commit-hash>

Example:

```
supervisor@rtbrick>LEAF01: cfg> rollback commit-id
29d5db038c1920fddsdsdsdsd323232
```

## **Loading Configuration**

To load configurations, enter the following command:

### **load config** <filename> <option>

The options include **merge** and **replace**. You can specify **merge** after the file name

to merge the configuration with the running configuration. Specify **replace** to replace the running configuration with the new one. Without any option, it replaces the running configuration, by default.

```
supervisor@rtbrick>LEAF01: cfg> load config <filename>
```



- Ensure that you use '.json' at the end of the filename.
- Remember to commit your changes after loading.

## Viewing Routes

The **show route** command displays information of routes.

### Syntax:

**show route** <options>

Attribute	Description
-	Without any option, the command displays the information for all routes for all modules.
detail	Shows detailed route information.
instance <name>	Routing table information for a specified instance.
ipv4	Shows route information for the IPv4 routing table.
ipv6	Shows route information for the IPv6 routing table.
mpls	Shows route information for the MPLS routing table.
label <value>	Shows route information for a specified destination label.
prefix <value>	Shows route information for a specified destination prefix.
prefix-length-distribution	Shows the number of routes with the same prefix length for the sources.
source	Shows routes from a specified source.
summary	Shows the number of routes selected by RIBD for each source.

Example 1: Route information

```

supervisor@rtbrick>LEAF01: op> show route
Instance: default, AFI: ipv4, SAFI: unicast
Prefix/Label      Source           Pref  Next Hop           Interface
11.0.0.1/32       arp-nd           6     11.0.0.1           hostif-0/0/4/1
12.1.0.0/24       ospf              10    23.0.0.2           hostif-0/0/0/1
23.0.0.0/24       direct            0     23.0.0.0           hostif-0/0/0/1
25.0.1.0/24       ospf              10    23.0.0.2           hostif-0/0/0/1
25.1.1.0/24       ospf              10    23.0.0.2           hostif-0/0/0/1
34.0.3.3/32       direct            0     34.0.3.3           hostif-0/0/2/1
56.0.1.4/30       ospf              10    23.0.0.2           hostif-0/0/0/1
56.0.2.0/31       ospf              10    34.0.2.4           hostif-0/0/1/1
    
```

## Example 2: Route summary

```

supervisor@rtbrick>LEAF01: cfg> show route summary
Instance: default
  Source           Routes
  bgp               2
  direct            4
  Total Routes     6
Instance: ip2vrf
  Source           Routes
  bgp               6
  direct            2
  Total Routes     8
Instance: li-vrf
  Source           Routes
  bgp               4
  direct            2
  Total Routes     6
Instance: mgmt-vrf
  Source           Routes
  bgp               2
  direct            2
  Total Routes     4
Instance: radius-vrf
  Source           Routes
  bgp               5
  direct            2
  Total Routes     7
    
```

## Example 3: Routes with the same prefix length for IPv4

```

supervisor@rtbrick>LEAF01: cfg> show route prefix-length-distribution
Instance: default
  Prefix Length    Count
  /32               2
  /128              4
  Sum               6
Instance: ip2vrf
  Prefix Length    Count
  /0                2
  /24               1
  /32               2
  /64               1
    
```

```

        /128          2
        Sum          8
Instance: li-vrf
  Prefix Length    Count
        /0          2
        /32         2
        /128        2
        Sum         6
Instance: mgmt-vrf
  Prefix Length    Count
        /32         2
        /128        2
        Sum         4
Instance: radius-vrf
  Prefix Length    Count
        /0          2
        /24         1
        /32         2
        /128        2
        Sum         7
    
```

### Viewing Route Resolution

The `show route-resolution` command displays the routes which were requested to be resolved for their nexthops. Otherwise, it shows the route is unresolved.

**Syntax:**

`show route-resolution <options>`

-	<b>Without any option, the command displays the information for all requests and response tables side by side.</b>
destination-instance	Displays the information for all requests and response for a destination instance.
look-up instance	Displays lookup instance routes.
prefix	Displays routes for prefix 4 or prefix 6.
resolved	Displays resolved routes.
source	Displays source of requested source.
unresolved	Displays unresolved routes.

**Example:**

```

supervisor@L1-STD-2-2008>bm08-tst.hel.rtrbrick.net: op> show route-resolution
192:1::1, Source: bgp
  Destination instance: default, AFI: ipv4, SAFI: vpn-unicast
  Lookup instance: default, AFI: ipv6, SAFI: labeled-unicast
    
```



```

Covering Prefix: 192:1::1/128
  Interface      MAC Address      Nexthop
  hostif-0/0/1/10  7a:11:21:c0:00:03  fe80::7811:21ff:fec0:3
192:1::1, Source: bgp
Destination instance: default, AFI: ipv4, SAFI: vpn-multicast
Lookup      instance: default, AFI: ipv6, SAFI: labeled-unicast
Covering Prefix: 192:1::1/128
  Interface      MAC Address      Nexthop
  hostif-0/0/1/10  7a:11:21:c0:00:03  fe80::7811:21ff:fec0:3
<...>

```

### Example:

```

supervisor@rtbrick>ufi07.q2c.u21.r4.nbg.rtbrick.net: cfg> show route-resolution
unresolved
192.168.16.128, Source: radius
  Lookup      instance: inband_mgmt, AFI: ipv4, SAFI: unicast
  Covering Prefix: None, 7 resolution attempts
198.18.73.251, Source: pim
  Lookup      instance: ip2, AFI: ipv4, SAFI: unicast
  Covering Prefix: None, 7 resolution attempts

```

## Managing RBFS Services

### Brick Daemons

RBFS microservices architecture allows daemons to serve various complementary functions and provide services.

For example, the subscriber daemon (**subscriberd**) manages the current subscriber state and is responsible for authentication, authorization, and accounting. The **ribd** daemon is responsible for route selection, next-hop resolution, tunnel selection and recursion.

There are daemons such as **CtrlD** (Controller) and **ApiGwD** (API Gateway) which are part of the RBFS ecosystem. These daemons sit in the middle (on the ONL) and manage all the communication between the client and backend services running in the container. The API Gateway (**ApiGwD**) daemon provides a single point access to expose services running inside of the RBFS container.

RBFS daemons and other dependencies are packaged as an Ubuntu LXC container. The RBFS container is hosted on the Open Network Linux (ONL), an open-source operating system, which can be run on white box switches.

RBFS can perform various roles such as Spine, Leaf, and Consolidated BNG which serve different use-cases. The software images of these various roles contain

daemons that are required to serve these roles for their different functions. The RBFS Consolidated BNG software image contains all the RBFS daemons packaged in a container, other roles such as Spine and Leaf include only the daemons which are required to carry out their respective functions.

For example, the Spine RBFS image includes (in addition to other daemons) the interior gateway protocol daemons such as `isis.appd`, `isis.iod`, `ospf.appd`, and `ospf.iod` which are not required in the Access Leaf image.

Similarly, the Access Leaf image should include daemons (in addition to other daemons) such as `subscriberd`, `l2tpd`, `pppoed`, and `ipoed` which are not present in the Spine image.

The daemons such as `alertmanager`, `confd`, `etcd`, `fibd`, `hostconfd`, `ifmd` and so on are present in the images of both the Spine and Leaf roles as these daemons are required in both of these roles.

## Launching Microservices Dynamically

When the RBFS container starts up, it starts only relevant microservices depending on the image role and platform. This is done to minimize unnecessary resource consumption. In RBFS, there are base microservices and on-demand microservices. RBFS containers will have all microservices installed according to the platform and image role, but not all will be enabled on bootup. Only the base microservices will be enabled and started on bootup. On-demand microservices will only be started when their respective configurations are configured and will stop once all dependent configurations are deleted.

For instance, when the user configures BGP with the CLI command `set instance <instance> protocol bgp local-as <as-number>`, the `rtbrick-bgp.appd.1` and `rtbrick-bgp.iod.1` services will start. And, once the BGP configuration is deleted, "`rtbrick-bgp.appd.1`" and "`rtbrick-bgp.iod.1`" will be stopped after 5 minutes (graceful shutdown time).

By default, the following base microservices will be running in the container.

- `rtbrick-confd`
- `rtbrick-etcd`
- `rtbrick-fibd`
- `rtbrick-hostconfd`

- rtbrick-ifmd
- rtbrick-lldpd
- rtbrick-mribd
- rtbrick-opsd
- rtbrick-poold
- rtbrick-resmond
- rtbrick-resmond-agent
- rtbrick-restconfd
- rtbrick-ribd
- rtbrick-staticd

When you make other RBFS configurations, the required on-demand microservices will be automatically enabled.

### Listing All Available Services

To list all available RBFS services, enter the following command:

```
sudo systemctl list-unit-files | grep "rtbrick-"
```

### Starting or Stopping the Services

To start or stop a specific RBFS service, enter the following command:

```
sudo service <service> start|stop
```

### Restarting a Service

To restart a specific RBFS service, enter the following command:

```
sudo service <service> restart
```

Example:

```
supervisor@onl>C-BNG.rtbrick.net:~ $ sudo service rtbrick-ctrld restart
```



- In the unlikely event of a failure in a daemon, the service will restart automatically.
- If a service has restarted too frequently within a short period, it may be blocked by the system to prevent further instability. In such cases, the service can be unblocked by resetting its failure state with the `sudo systemctl reset-failed <service>` command. This ensures that the service is no longer considered “failed” by the system and can be managed normally again. Including this information in the documentation will help users manage and troubleshoot their RBFS services effectively, ensuring smoother operations and reducing downtime caused by blocked or unstable services.

## Verifying the Status of a Service

To verify the status of a RBFS Service, enter the following command:

```
sudo service <service> status
```

For example, to check the status of the `rtbrick-pppoed.1` service, enter the following command:

```
supervisor@onl>C-BNG.rtbrick.net:~ $ sudo service rtbrick-pppoed.1 status
```

## Removing the Committed/Uncommitted Configuration

To discard the both committed and uncommitted configurations, enter the following command:

```
supervisor@rtbrick>LEAF01: cfg> discard all
```



Carefully use the `discard all` command because it will remove your committed configurations.

## Supported Platforms

Not all features are necessarily supported on each hardware platform. Refer to the *Platform Guide* for the features and the sub-features that are or are not supported by each platform.

## 1.2. BDS Overview

### 1.2.1. BDS Overview

The Brick Data Store (BDS) is a purpose-built, in-memory state database optimized for cloud networking. In RBFS, all system state information is stored as objects in BDS tables. Objects are entries in BDS tables that represent a state.

#### Pub/Sub Model

All Brick Daemons (BD) independently publish and subscribe to tables in a pub/sub model. This model provides resilience and scalability. The figure illustrates the concept:

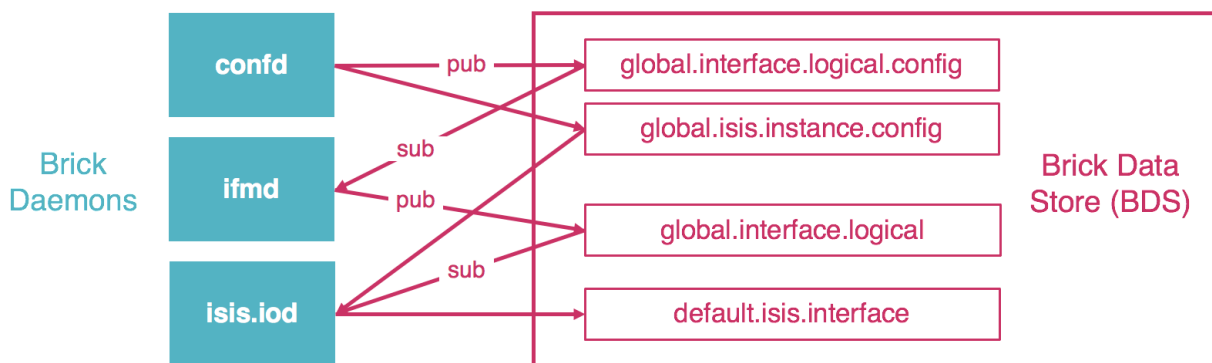

In this example, the configuration daemon (confd) publishes tables that contain configuration data for logical interfaces or IS-IS instances. The interface management daemon (ifmd) is responsible for creating and maintaining interfaces. It therefore subscribes for example to the logical interface configuration table. After processing the data, it creates the logical interfaces and publishes them in the logical interface table. The IS-IS input/output daemon (isis.iod) subscribes to the logical interface table as well as the IS-IS configuration tables. It in turn creates and runs interfaces on which IS-IS protocol packets are exchanged, and publishes them in the IS-IS interface table.

#### BDS User Interface

All BDS tables and objects are fully accessible to the RBS user both via CLI and an API. This provides unprecedented visibility into the system state. This guide covers the BDS CLI. For the BDS API, refer to the BDS API Reference.

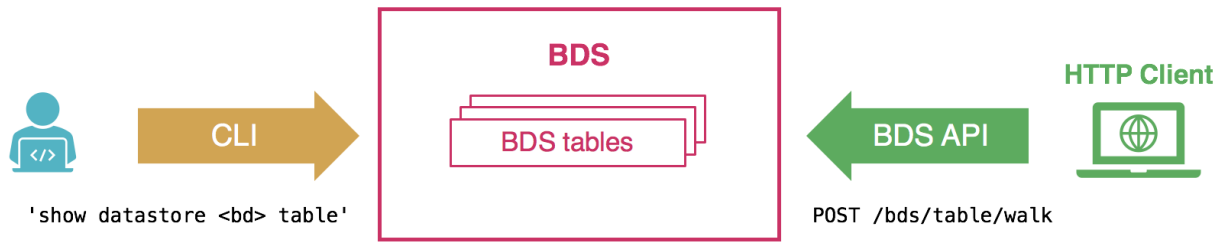

Please note the RBFS CLI supports show commands to verify the configuration and operation of the system for all features. Therefore you usually do not need to inspect BDS tables directly. For example, for verifying the status of the logical interfaces, you can simply use the 'show interface summary' or the 'show interface logical' commands, instead of displaying the logical interface table. The BDS CLI and API to inspect BDS tables are rather available in addition to advanced analysis or troubleshooting.

## Supported Platforms

Not all features are necessarily supported on each hardware platform. Refer to the *Platform Guide* for the features and the sub-features that are or are not supported by each platform.

### 1.2.2. BDS Operational Commands

This section summarizes some useful BDS CLI commands. It assumes you have some basic knowledge of BDS, and are familiar with the respective tables you are looking for. Describing all tables involved in a particular feature or functionality is out of the scope of this guide.

#### BDS Summary

The BDS summary command provides some metadata of the BDS tables.

Syntax:

**show datastore** <bd-name> **summary** <option>

Option	Description
<bd-name>	Name of the brick daemon to request this information from. As all BDs independently publish and subscribe to BDS tables, they all hold a different set of tables. As a best practice, select the BD that owns the respective table you are looking for.
table <table-name>	Display metadata for the given table.

Example:

```

supervisor@rtbrick>LEAF01: op> show datastore ribd summary
Brick Datastore Summary:
Table Name: local.bds.table.registry.ribd
  Index                                     Type                                     Active
Obj Memory   Index Memory
sequence-index          bds_rtb_bplus                          234
24.38 KB      9.59 KB
gc-index             bds_rtb_bplus                          0  0
bytes          0 bytes
table-name-index     bplus                                   234
24.38 KB      9.59 KB
Table Name: local.trim.qrunner.table
  Index                                     Type                                     Active
Obj Memory   Index Memory
sequence-index          bds_rtb_bplus                          7
840 bytes     728 bytes
gc-index             bds_rtb_bplus                          0  0
bytes          0 bytes
immutable_index       bplus                                   7
840 bytes     728 bytes
qrunner-index         qrunner                                 7
840 bytes     728 bytes
Table Name: local.bds.statistics
  Index                                     Type                                     Active
Obj Memory   Index Memory
sequence-index          bds_rtb_bplus                          319
34.84 KB     14.36 KB
gc-index             bds_rtb_bplus                          0  0
bytes          0 bytes
immutable-index       bplus                                   319
34.84 KB     14.36 KB
Table Name: local.bds.module.registry
  Index                                     Type                                     Active
Obj Memory   Index Memory
sequence-index          bds_rtb_bplus                          68
3.53 KB      2.79 KB
gc-index             bds_rtb_bplus                          0  0
bytes          0 bytes
module-name-index     bplus                                   68
3.53 KB      2.79 KB
<...>

```

## BDS Tables

You can use the BDS table commands to display the table objects that contain the actual state information.

Syntax:

**show datastore** <bd-name> **table** <option>

Option	Description
<bd-name>	Name of the brick daemon to request this information from. As all BDs independently publish and subscribe to BDS tables, they all hold a different set of tables. As a best practice, select the BD that owns the respective table you are looking for.
<table-name>	Name of the BDS table to display. Without further options, this command displays all objects in a table format.
<table-name> json	Display the complete table data in JSON format.
<table-name> attribute <attribute-name> <attribute-value> exact	Filter the table objects based on attribute name and value. You can filter on any attribute, except for attributes of type array. The filter performs a regex match. You can therefore specify the attribute value as a regular expression (regex). You can use the exact match along with the (default) regular expression match.
<table-name> summary	Display metadata for the given table.
properties	Display owner, published/subscribed, and locality information for all tables known by the given daemon.

Example 1: Logical Interface Table



```

supervisor@rtbrick>LEAF01: op> show datastore ifmd table global.interface.logical
Object: 0, Sequence 100125, Last update: Mon Apr 03 13:49:39 GMT +0000 2023
  Attribute                                     Type                                     Length
Value
  logical_unit_id (1)                          uint16 (3)                             2
0
  ifl_name (2)                                  string (9)                              13
ifl-0/1/31/0
  ifp_name (3)                                  string (9)                              11
ifp-0/1/31
  instance (5)                                  string (9)                              8
default
  mac_address (8)                              macaddr (22)                           6
e8:c5:7a:8f:76:f2
  ipv4_status (10)                             uint8 (2)                               1
up
  ipv6_status (12)                             uint8 (2)                               1
up
  mpls_mtu (13)                                uint16 (3)                              2
1500
  mpls_status (14)                             uint8 (2)                               1
up
  iso_mtu (15)                                  uint16 (3)                              2
1500
  iso_status (16)                              uint8 (2)                               1
down
  admin_status (17)                            uint8 (2)                               1
up
  link_status (18)                             uint8 (2)                               1
up
  ifl_type (19)                                uint8 (2)                               1
Logical Sub interface
  operational_status (24)                      uint8 (2)                               1
up
  ifindex (25)                                 uint32 (4)                              4
63745
  instance_id (27)                             uint32 (4)                              4
0
<...>
    
```

## Example 2: Filter IPv6 Route Table by Prefix

```

supervisor@rtbrick>LEAF01: op> show datastore ribd table default.ribd.1.fib-
local.ipv6.unicast
  attribute prefix6 2001:db8::1/128
Object: 0, Sequence 1900002, Last update: Mon Apr 03 13:49:39 GMT +0000 2023
  Attribute                                     Type                                     Length
Value
  prefix6 (4)                                  ipv6prefix (16)                         17
2001:db8::1/128
  source (11)                                  uint8 (2)                               1
direct
  sub_src (12)                                 uint8 (2)                               1
Host
  nexthop_key (25)                             payload (8)                              24
3c86eaebe6617cf61ed96c819cfd63839bd90cc85a533067
  preference (40)                              uint32 (4)                              4
0
    
```



Option	Description
<bd-name>	Name of the brick daemon to request this information from. As all BDs independently publish and subscribe to BDS tables, they all hold a different set of tables. To view a table or object schema, you can select any BDs that know the respective table.
table-name <table-name>	Display the schema of the given table.
object object-name <object-name>	Display the schema of the given object.
object table-name <table-name>	Display the schema of the object for a given table. This option is useful if you do not know the name of the object but the name of the table in which it is used.

## BDS Statistics Memory

The BDS statistics memory command provides detailed memory usage information.

Syntax:

**show datastore** <bd-name> **statistics memory**

Option	Description
<bd-name>	Name of the brick daemon of which to display the memory usage information.

## 2. Routing

### 2.1. RIB

#### 2.1.1. RIB Overview

A Routing Information Base (RIB) stores and maintains the route information. The RIB table contains information about each reachable network prefix and the next hop information. Each routing protocol inserts its routes into the RIB when it learns a new route. The RBFS route manager (ribd) selects the best routes from the protocol RIBs and places them into the Forwarding Information Base (FIB) table. If a destination becomes unreachable, the route is marked unusable and eventually removed from the RIB

The main differences between RIB and FIB are:

- RIB is about storing and maintaining route information, including attributes for route selection (control plane), etc.
- FIB is used to determine how packets are forwarded (data plane), i.e., only contains a subset of information from RIB. Also, FIB is downloaded to ASIC or VPP.

The image below shows how various routing protocols insert their routes into the RIB.

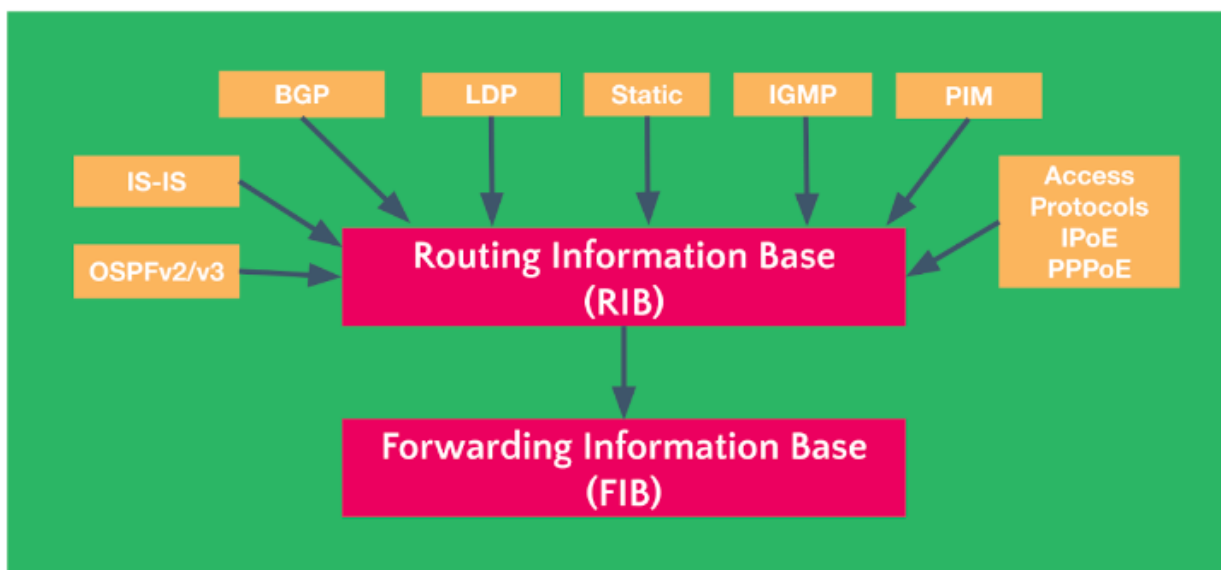

## Routing Instances

A routing instance represents a set of interfaces, routing protocols, and corresponding routing tables. You can think of a routing instance as a virtual router within RBFS.

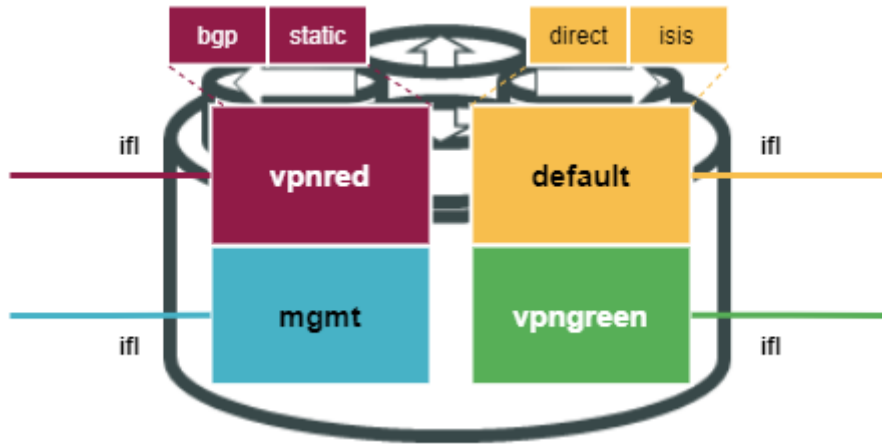

Each logical interface (ifl) is associated uniquely with a routing instance. If no routing instance is explicitly configured, the default routing instance is used. The interface association can be seen with the `show interface address` command.

Routing instances are configured using the `set instance <instance_name>` syntax. When configuring a routing instance, you must specify which address families (AFI, SAF) the routing instance should support.

## Route Preference

Several routing protocols, including static routes, may provide multiple paths to reach a particular destination. However, not all of these paths are necessarily optimal. At any given time, only one routing protocol can identify the most optimal route to the destination. Each routing protocol, including static routes, is given a preference value, where lower values indicate higher preference. In cases where multiple routing sources are present, the route identified by the routing protocol with the highest preference is selected as the best option and added to the local routing table.

Routing Protocol	Route Preference
Direct	0
Static	2
IPoE	7

<b>Routing Protocol</b>	<b>Route Preference</b>
PPP	8
LDP	9
OSPF	10
IS-IS LEVEL 1	15
IS-IS LEVEL 2	18
eBGP	20
iBGP	200

## **Route Selection**

RIBD obtains routes and corresponding next-hops from various sources such as static, protocols, and direct connections. Route selection and resolution are also handled by RIBD, which chooses the best route based on the preference assigned to each source. If multiple sources provide the same prefix, RIBD will select the best route based on the source's preference and install it in FIBD.

## **Route Resolution**

Route resolution is the process of finding the forwarding next hop from protocol nexthop downloaded into RIBD. For this purpose RIBD performs recursive route lookups till it finds a direct outgoing interface for the route.

For example, BGP installs a route with nexthop set to its peer IP address. However, it doesn't provide the outgoing interface. So, RIBD will check the peer IP address (next-hop IP) in its routing table (most probably downloaded by IGP) and find the directly connected router's IP address and its outgoing nexthop.

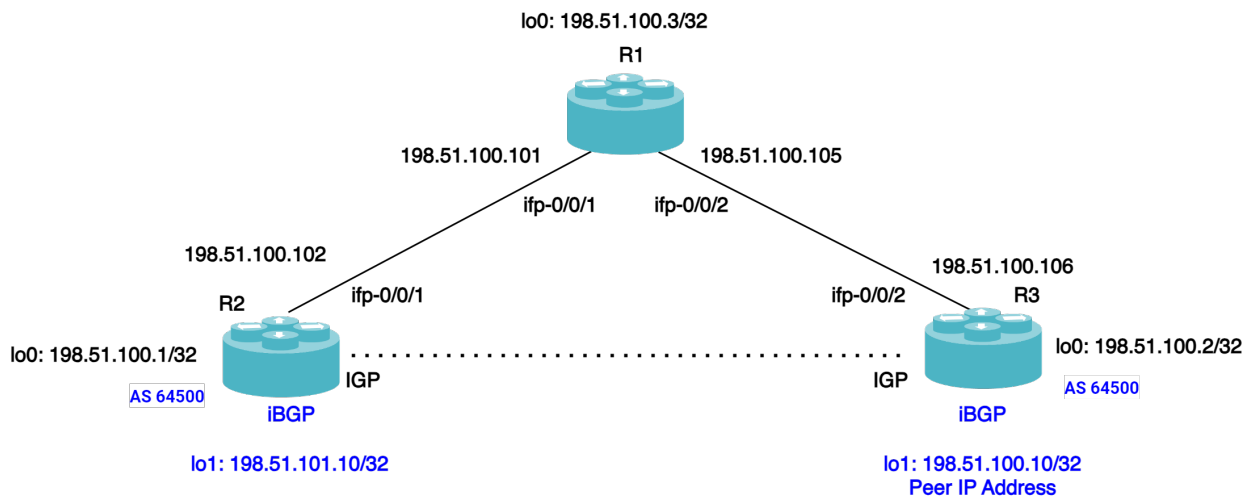

The BGP route for 198.51.100.10/32 will only be added to the routing table of router R2 if the IP address listed as the next-hop attribute is already reachable based on the information stored in the routing table. Additionally, the BGP route that is installed will contain a reference to the next-hop address 198.51.100.2 (refer to the figure above).

The network 198.51.100.10/32 can be accessed through an IP address that is not directly connected. The physical interface is not located where the BGP route is installed, so it is added to the IP routing table without any information about the outgoing interface. To find the BGP next-hop in the routing table, the router must perform a recursive lookup. However, to use a BGP route, the BGP next-hop IP address must be reachable. This is usually done through an IGP that provides reachability information. In this case, the BGP next-hop 198.51.100.2 is found in the routing table of R2, which is known via OSPF. The outgoing interface is ifp-0/0/1.

During the first route lookup, the router checks whether the destination prefix is in the routing table. If it is, then a recursive lookup is performed for the next-hop IP address. Since the next hop address is not a directly connected interface, the router needs to do a recursive lookup to find it.

Below is an example of the BGP route resolution for prefix:198.51.100.10/32:

```

supervisor@rtbrick>C-BNG.rtbrick.net: op> show route-resolution resolved prefix
198.51.100.10
198.51.100.10, Source: bgp
  Destination instance: default, AFI: ipv4, SAFI: unicast
  Lookup instance: default, AFI: ipv4, SAFI: unicast
  Covering Prefix: 198.51.100.10
  Interface          MAC Address          Nexthop
  if1-0/0/1/13      e8:c5:7a:8f:56:47    198.51.100.101
    
```

```
supervisor@rtbrick>C-BNG.rtbrick.net: op>
```

## Policy Attachments

Routing Policies are a set of rules that enable you to manage and alter the default behavior of routing protocols, like BGP and IS-IS. Such policies consist of various "terms," which include "match" and "action" sections with control. The traffic that matches the "match" block is handled by the "action" block.

Once policies have been created, they need to be applied to take effect. Attachment points describe the specific applications and processes to which policies can be applied.

For more information, see section "2.2.4. Attaching Policies" of the Policy User Guide.

## Nexthops

Nexthop helps routers determine the best path for forwarding data packets to their final destination efficiently. The next hop is identified by its IP address, which is stored in the routing table alongside the associated network prefix and other routing information.

## Adjacency

The FIB learns the routing information from the routing table and tracks the next hop for all routes. The adjacency table maintains Layer 2 information(Nexthop) for the routes listed in the FIB (the resolved routes that can be installed into the hardware).

## FIB

FIB determines how packets are forwarded (data plane), i.e., it only contains a subset of information from RIB. Also, FIB is downloaded to ASIC or VPP.

The main difference between the RIB and the FIB is that the RIB contains all the routes the router has learned, while the FIB only contains the best paths to each destination network. The RIB is constantly updated by the routing protocols and static configuration, while the FIB is only updated when the router needs to recalculate the best paths. The FIB is also updated more quickly than the RIB since



it only needs to store the best paths and not all routes. The FIB maintains next-hop address information based on the information in the IP routing table.

## 2.1.2. RIB Operational commands

### Display Routes

The show route command displays information on routes.

#### Syntax:

**show route** <option>

Option	Description
-	Without any option, the command shows the information for all routes for all instances.
detail	Shows detailed route information.
import	The commands show all the routes imported from another instance. For information about route import command options, see section <a href="#">Show Route Import</a> .
incoming interface <name>	Shows the information of the specified interface through which the routes enter to the router.
instance <name>	Shows routing table information for a specified instance.
ipv4	Shows route information for the IPv4 routing table.
ipv6	Shows route information for the IPv6 routing table.
l2vpn	Shows route information for the L2VPN routing table. For information about l2vpn command options, see section <a href="#">Show Route L2VPN</a> .
mpls	Shows route information for the MPLS routing table.
prefix <value>	Shows route information for a specified destination prefix.
prefix-length-distribution	Shows the number of routes with the same prefix length for the sources.

Option	Description
service	Shows the number of routes with the same service label.
source	Shows routes from a specified source.
summary	Shows the number of routes selected by RIB for each source.

Example 1: The following example shows route information.

```

supervisor@rtbrick>LEAF01: op> show route
Instance: default, AFI: ipv4, SAFI: unicast
Prefix/Label      Source      Pref  Next Hop
Interface
192.1.0.3/32      direct      0     192.1.0.3
lo-0/0/0/1

Instance: default, AFI: ipv4, SAFI: labeled-unicast
Prefix/Label      Source      Pref  Next Hop
Interface          Label
192.1.0.3/32      direct      0     192.1.0.3
lo-0/0/0/1        -
Instance: default, AFI: ipv6, SAFI: unicast
Prefix/Label      Source      Pref  Next Hop
Interface
192:1::2/128      bgp         20    fe80::eac5:7aff:fe8f:5663
ifl-0/1/70/13
192:1::3/128      direct      0     192:1::3
lo-0/0/0/1

192:1::4/128      bgp         20    fe80::eac5:7aff:fe8f:5663
ifl-0/1/70/13
Instance: default, AFI: ipv6, SAFI: labeled-unicast
Prefix/Label      Source      Pref  Next Hop
Interface          Label
192:1::2/128      bgp         20    fe80::eac5:7aff:fe8f:5663
ifl-0/1/70/13      -
192:1::3/128      direct      0     192:1::3
lo-0/0/0/1        -
192:1::4/128      bgp         20    fe80::eac5:7aff:fe8f:5663
ifl-0/1/70/13      2020
    
```

Example 2: A route summary is shown in the following example.

```

supervisor@rtbrick>LEAF01: op> show route summary
Instance: default
Source      Routes
bgp         4
direct      4
Total Routes 8
Instance: inband-vrf
Source      Routes
bgp         4
direct      2
Total Routes 6
Instance: ip2vrf
Source      Routes
bgp         3
    
```

```

direct                2
Total Routes          5
Instance: li-vrf
Source                Routes
bgp                   2
direct                2
Total Routes          4
Instance: mgmt-vrf
Source                Routes
bgp                   4
direct                2
Total Routes          6
Instance: radius-vrf
Source                Routes
bgp                   3
direct                2
Total Routes          5
    
```

Example 3: This example shows routes with IPv4 prefixes of the same length

```

supervisor@rtbrick>LEAF01: op>> show route prefix-length-distribution
Instance: default
  Prefix Length  Count
      /32         2
      /128        6
      Sum         8
Instance: inband-vrf
  Prefix Length  Count
      /32         3
      /128        3
      Sum         6
Instance: ip2vrf
  Prefix Length  Count
      /24         1
      /32         2
      /128        2
      Sum         5
Instance: li-vrf
  Prefix Length  Count
      /32         2
      /128        2
      Sum         4
Instance: mgmt-vrf
  Prefix Length  Count
      /32         3
      /128        3
      Sum         6
Instance: radius-vrf
  Prefix Length  Count
      /24         1
      /32         2
      /128        2
      Sum         5
    
```

## Show Route Import

### Syntax:

**show route import** <option>

Option	Description
import	The command shows all the routes imported from another instance.
detail	Shows detailed information for imported routes.
instance	Shows routing table information for a specific instance for imported routes.
ipv4	Shows route information for the IPv4 routing table for imported routes.
ipv6	Shows route information for the IPv4 routing table for imported routes.
source	Shows source of the routing information for the specified source.
summary	Shows the number of imported routes selected by RIB for each source.

## Show Route L2VPN

### Syntax:

**show route l2vpn** <option>

Option	Description
l2vpn	Without any option, the commands display all the L2VPN routes.
detail	Shows detailed information for l2vpn routes.
evpn-vpws	Shows routing table information for the EVPN-VPWS address family.
instance	Shows L2VPN routing table information for a specific instance

Option	Description
label <label>	Shows L2VPN routing table information for destination label.
prefix	Shows L2VPN routing table information for the destination prefix.
source	Shows source information for the L2VPN routes.
summary	Shows the number of L2VPN routes selected by RIBD for each source.
vpls-vpws	Shows the L2VPN routes from VPLS-VPWS address specified.

## Show Route Resolution

The `show route-resolution` command displays the routes that were requested to be resolved for their nexthops. Otherwise, it shows the route is unresolved.

### Syntax:

`show route-resolution <options>`

Option	Description
-	Without any option, the command shows the information for all requests and response tables side by side.
destination-instance	Shows the information for all requests and responses for a destination instance.
look-up instance	Shows lookup instance routes.
prefix	Shows routes for prefix 4 or prefix 6.
resolved	Shows resolved routes.
source	Shows source of requested source.
unresolved	Shows unresolved routes.

Example 1: Below is an example of the route resolution requested by the protocol BGP.

```
supervisor@rtbrick>LEAF01: op> show route-resolution
```

```

192:1::2, Source: bgp
  Destination instance: default, AFI: ipv4, SAFI: vpn-multicast
  Lookup instance: default, AFI: ipv6, SAFI: labeled-unicast
  Covering Prefix: 192:1::2/128
    Interface      MAC Address      Nexthop
    if1-0/1/70/13  e8:c5:7a:8f:56:63  fe80::eac5:7aff:fe8f:5663
fe80::eac5:7aff:fe8f:5663, Source: bgp
  Destination instance: default, AFI: ipv6, SAFI: unicast
  Lookup instance: default, AFI: ipv6, SAFI: unicast
  Covering Prefix: fe80::eac5:7aff:fe8f:5663/128
    Interface      MAC Address      Nexthop
    if1-0/1/70/13  e8:c5:7a:8f:56:63  fe80::eac5:7aff:fe8f:5663
fe80::eac5:7aff:fe8f:5663, Source: bgp
  Destination instance: default, AFI: ipv4, SAFI: vpn-unicast
  Lookup instance: default, AFI: ipv6, SAFI: labeled-unicast
  Covering Prefix: fe80::eac5:7aff:fe8f:5663/128
    Interface      MAC Address      Nexthop
    if1-0/1/70/13  e8:c5:7a:8f:56:63  fe80::eac5:7aff:fe8f:5663
fe80::eac5:7aff:fe8f:5663, Source: bgp
  Destination instance: default, AFI: ipv6, SAFI: labeled-unicast
  Lookup instance: default, AFI: ipv6, SAFI: labeled-unicast
  Covering Prefix: fe80::eac5:7aff:fe8f:5663/128
    Interface      MAC Address      Nexthop
    if1-0/1/70/13  e8:c5:7a:8f:56:63  fe80::eac5:7aff:fe8f:5663
fe80::eac5:7aff:fe8f:5663, Source: bgp
  Destination instance: default, AFI: ipv6, SAFI: vpn-unicast
  Lookup instance: default, AFI: ipv6, SAFI: labeled-unicast
  Covering Prefix: fe80::eac5:7aff:fe8f:5663/128
    Interface      MAC Address      Nexthop
    if1-0/1/70/13  e8:c5:7a:8f:56:63  fe80::eac5:7aff:fe8f:5663

```

## Show Route rib-in

The `show route rib-in` command shows all advertised routes' information received and stored in the inbound RIB (Routing Information Base). These commands allow you to view routes based on specific criteria such as instance, source, address family (AFI), subsequent address family identifier (SAFI) and so on.

### Syntax:

`show route rib-in <options>`

Option	Description
-	Without any option, the command shows the information for all routes in the routing information base.
detail	Provides a detailed view of routes matching the specified prefix in the inbound RIB.

Option	Description
<afi>	To show only the routes for a specific network protocol, such as IPv4 or IPv6.
<safi>	To view specific types of routes, such as IPv4 unicast or IPv6 multicast, received from neighbors.
instance <instance>	Shows the routes in the inbound RIB of a specific routing instance.
source <source>	Shows the routes in the inbound RIB from a specific neighbor.
summary	Provides a summary view of all routes in the inbound RIB.

## Show Route Prefix

The **show route prefix** command shows all advertised routes' information received and stored in the inbound RIB (Routing Information Base).

### Syntax:

**show route prefix** <options>

Option	Description
-	Without any option, the command shows the information for all routes in the routing information base.
prefix <value>	Specify the prefix. This is to see if a specific route with a particular prefix has been received from a neighbor.
rib-in	Shows all routes currently stored in the routing information base without any filtering.
detail	Provides a detailed view of routes matching the specified prefix in the inbound RIB.

## 2.2. Route Leaking

## 2.2.1. Route Leaking Overview

Route leaking involves exporting a route from one routing instance to another routing instance.

As shown in the figure below, RBFS allows importing routes from the RIB of one instance to another instance. Additionally, the routes can be selectively imported based on the associated policy.

*Route Leaking Across Instances*

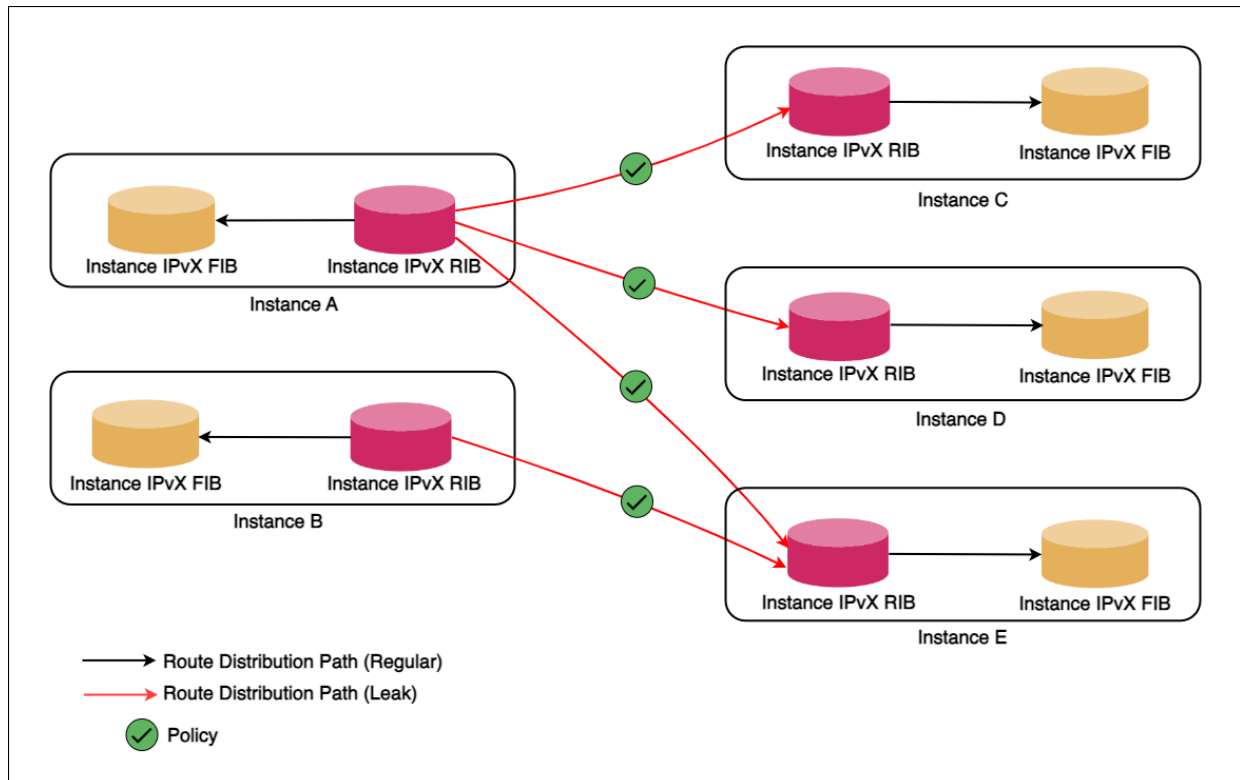

### Guidelines and Limitations

- Currently, the route leaking “import-rib” feature is limited to importing only IPv4 and IPv6 unicast routes.

### Supported Platforms

The Route Leaking feature is supported by the consolidated BNG images for the following Q2A and Q2C hardware platforms.

#### Q2A:

- Edgecore CSR440 (AS7535-28XB)



- UfiSpace S9510-28DC

### Q2C:

- Edgecore AGR420 (AS7946-74XKSB)
- UfiSpace S9600-72XC
- UfiSpace S9600-102XC

## 2.2.2. Route Leaking Configuration

### Configuring Route Leaking from one instance to another

To configure route leaking from one instance to another, configure the "import-rib" for the routing instance (AFI/SAFI).

#### Syntax:

```
set instance <destination-instance> address-family <afi> <safi> import-rib
<source-instance>
```

Attribute	Value
<destination-instance>	Name of the routing instance to which routes will be imported to.
<afi>	Address family identifier (AFI). Supported values: ipv4, ipv6.
<safi>	Subsequent address family identifier (SAFI). Supported values: unicast.
<source-instance>	Specifies the routing instance from which the routes will be imported.

In the following example, IPv4 and IPv6 unicast routes will be copied from the "vrf-blue" to "vrf-red" instance RIB.

```
set instance vrf-red address-family ipv4 unicast import-rib vrf-blue
set instance vrf-red address-family ipv6 unicast import-rib vrf-blue
```

The following is an example of JSON output showing the instance configuration.

```
supervisor@rtbrick>LEAF01: cfg> show config instance vrf-red
{
```

```

"rtbrick-config:instance": [
  {
    "name": "vrf-red",
    "address-family": [
      {
        "afi": "ipv4",
        "safi": "unicast",
        "import-rib": [
          {
            "instance": "vrf-blue"
          }
        ]
      },
      {
        "afi": "ipv6",
        "safi": "unicast",
        "import-rib": [
          {
            "instance": "vrf-blue"
          }
        ]
      }
    ]
  }
]
    
```

## Configuring Route Leaking with Policy

You can attach a policy to import selective routes as per the required criteria.

### Syntax:

**set instance** <destination-instance> **address-family** <afi> <safi> **import-rib** <source-instance> **policy** <policy-name>

Attribute	Value
<destination-instance>	Name of the routing instance to which routes will be imported to.
<afi>	Address family identifier (AFI). Supported values: ipv4, ipv6.
<safi>	Subsequent address family identifier (SAFI). Supported values: unicast.
<source-instance>	Name of the routing instance to which routes will be imported.
<policy-name>	Name of the routing instance to which routes will be imported based on the specified policy.

In the following example, the policy `match_ipv4_prefix` is attached to the 'vrf-blue' instance.

```
set instance vrf-red address-family ipv4 unicast import-rib vrf-blue policy
match_ipv4_prefix
```

Example: The following is an example of JSON output of the above configuration.

```
{
  "rtbrick-config:instance": [
    {
      "name": "vrf-red",
      "address-family": [
        {
          "afi": "ipv4",
          "safi": "unicast",
          "import-rib": [
            {
              "instance": "vrf-blue",
              "policy": "match_ipv4_prefix"
            }
          ]
        }
      ]
    }
  ]
}
```

## 2.2.3. Route Leaking Operational Commands

### show route import

The `show route import` command displays all the imported routes.

#### Syntax:

`show route import <option>`

Attribute	Value
detail	Displays detailed route information of the imported routes.
instance <instance-name>	Displays route information for the imported routes for the specified instance.
instance <instance-name> detail	Displays detailed route information for the imported routes for the specified instance.

Attribute	Value
instances <instance-name> prefix <prefix>	Displays route information for the imported routes for the specified instance and prefix.
instance <instance-name> prefix <prefix> detail	Displays detailed route information for the imported routes for the specified instance and prefix.
instance <instance-name> summary	Displays summarized route information for the imported routes for the specified instance.
ipv4	Displays route information for the IPv4 address family.
ipv6	Displays route information for the IPv6 address family.
source	Displays route information for the specified route source.
summary	Display summarized route information for the imported routes.

### Example 1: Source instance (vrf-blue) RIB

```

supervisor@rtbrick>LEAF01: op> show route ipv4 unicast source bgp instance vrf-
blue
Flags: & - Imported
Instance: vrf-blue, AFI: ipv4, SAFI: unicast
Flags Prefix/Label Source Pref Next Hop Outgoing Interface
192.168.0.20/32 bgp 20 12.0.0.2 if1-0/0/2/0
192.168.0.21/32 bgp 20 12.0.0.2 if1-0/0/2/0
192.168.1.20/32 bgp 20 12.0.0.2 if1-0/0/2/0
192.168.1.21/32 bgp 20 12.0.0.2 if1-0/0/2/0
192.168.4.20/32 bgp 20 12.0.0.2 if1-0/0/2/0
supervisor@rtbrick>LEAF01: op>

```

### Example 2: Destination instance RIB

```

supervisor@rtbrick>LEAF01: op> show route import ipv4 unicast source bgp instance
vrf-red
Flags: & - Imported
Instance: vrf-red, AFI: ipv4, SAFI: unicast
Flags Prefix/Label Source Pref Next Hop Outgoing Interface
& 192.168.0.20/32 bgp 20 12.0.0.2 if1-0/0/2/0
& 192.168.0.21/32 bgp 20 12.0.0.2 if1-0/0/2/0
& 192.168.1.20/32 bgp 20 12.0.0.2 if1-0/0/2/0
& 192.168.1.21/32 bgp 20 12.0.0.2 if1-0/0/2/0
& 192.168.4.20/32 bgp 20 12.0.0.2 if1-0/0/2/0
supervisor@rtbrick>LEAF01: op>

```

### Example 3: Detailed view of the destination instance (vrf-red) RIB

```

supervisor@rtbrick>LEAF01: op> show route import ipv4 unicast source bgp instance
vrf-red detail
Instance: vrf-red, AFI: ipv4, SAFI: unicast
192.168.0.20/32
  Source: bgp, Preference: 20
  Import type: inter-instance, Import instance: vrf-blue
  Next Hop: 12.0.0.2
    Covering prefix: 12.0.0.2/32
    Next Hop type: direct, Next Hop action: None
    Resolved in: default-ipv4-labeled-unicast
    Outgoing Interface: if1-0/0/2/0, NextHop MAC: 7a:02:bb:c0:00:00
192.168.0.21/32
  Source: bgp, Preference: 20
  Import type: inter-instance, Import instance: vrf-blue
  Next Hop: 12.0.0.2
    Covering prefix: 12.0.0.2/32
    Next Hop type: direct, Next Hop action: None
    Resolved in: default-ipv4-labeled-unicast
    Outgoing Interface: if1-0/0/2/0, NextHop MAC: 7a:02:bb:c0:00:00
192.168.1.20/32
  Source: bgp, Preference: 20
  Import type: inter-instance, Import instance: vrf-blue
  Next Hop: 12.0.0.2
    Covering prefix: 12.0.0.2/32
    Next Hop type: direct, Next Hop action: None
    Resolved in: default-ipv4-labeled-unicast
    Outgoing Interface: if1-0/0/2/0, NextHop MAC: 7a:02:bb:c0:00:00
192.168.1.21/32
  Source: bgp, Preference: 20
  Import type: inter-instance, Import instance: vrf-blue
  Next Hop: 12.0.0.2
    Covering prefix: 12.0.0.2/32
    Next Hop type: direct, Next Hop action: None
    Resolved in: default-ipv4-labeled-unicast
    Outgoing Interface: if1-0/0/2/0, NextHop MAC: 7a:02:bb:c0:00:00
192.168.4.20/32
  Source: bgp, Preference: 20
  Import type: inter-instance, Import instance: vrf-blue
  Next Hop: 12.0.0.2
    Covering prefix: 12.0.0.2/32
    Next Hop type: direct, Next Hop action: None
    Resolved in: default-ipv4-labeled-unicast
    Outgoing Interface: if1-0/0/2/0, NextHop MAC: 7a:02:bb:c0:00:00
supervisor@rtbrick>LEAF01: op>

```

### Example 4: Destination instance (vrf-red) RIB after applying the policy (match\_ipv4\_prefix)

```

supervisor@rtbrick>LEAF01: op> show route import ipv4 unicast source bgp instance
vrf-red
Flags: & - Imported
Instance: vrf-red, AFI: ipv4, SAFI: unicast
Flags Prefix/Label      Source      Pref    Next Hop  Outgoing Interface
&      192.168.1.20/32      bgp       20       12.0.0.2  if1-0/0/2/0

```

In the above example, the below policy is used to import the selective route.

```
set policy statement match_ipv4_prefix
set policy statement match_ipv4_prefix ordinal 1
set policy statement match_ipv4_prefix ordinal 1 match
set policy statement match_ipv4_prefix ordinal 1 match rule 1
set policy statement match_ipv4_prefix ordinal 1 match rule 1 type ipv4-prefix
set policy statement match_ipv4_prefix ordinal 1 match rule 1 value-type discrete
set policy statement match_ipv4_prefix ordinal 1 match rule 1 match-type exact
set policy statement match_ipv4_prefix ordinal 1 match rule 1 value
192.168.1.20/32
set policy statement match_ipv4_prefix ordinal 1 action
set policy statement match_ipv4_prefix ordinal 1 action rule 1
set policy statement match_ipv4_prefix ordinal 1 action rule 1 operation return-
permit
```

The following is an example of JSON output showing the above policy configuration.

```
{
  "rtbrick-config:statement": [
    {
      "name": "match_ipv4_prefix",
      "ordinal": [
        {
          "ordinal": 1,
          "match": {
            "rule": [
              {
                "rule": 1,
                "type": "ipv4-prefix",
                "value-type": "discrete",
                "match-type": "exact",
                "value": [
                  "192.168.1.20/32"
                ]
              }
            ]
          },
          "action": {
            "rule": [
              {
                "rule": 1,
                "operation": "return-permit"
              }
            ]
          }
        }
      ]
    }
  ]
}
```

## 2.3. BGP

### 2.3.1. BGP Overview

BGP is a standard exterior gateway protocol (EGP) supported by RtBrick. BGP is considered a “Path Vector” routing protocol and maintains a separate routing table based on the shortest Autonomous System (AS) path and various other route attributes.

### Supported BGP Standards

RFC Number	Description
RFC 2545	Use of BGP-4 Multiprotocol Extensions for IPv6 Inter-Domain Routing
RFC 2918	Route Refresh Capability for BGP-4
RFC 4271	A Border Gateway Protocol 4 (BGP-4)
RFC 4364	BGP/MPLS IP Virtual Private Networks (VPNs)
RFC 4456	BGP Route Reflection: An Alternative to Full Mesh Internal BGP (IBGP)
RFC 4486	Subcodes for BGP Cease Notification Message
RFC 4760	Multiprotocol Extensions for BGP-4
RFC 5492	Capabilities Advertisement with BGP-4
RFC 6793	BGP Support for Four-Octet Autonomous System (AS) Number Space
RFC 6608	Subcodes for BGP Finite State Machine Error
RFC 6774	Distribution of Diverse BGP Paths [Partial Support]



RFC and draft compliance are partial except as specified.

### Supported Platforms

Not all features are necessarily supported on each hardware platform. Refer to the *Platform Guide* for the features and the sub-features that are or are not supported by each platform.

## Supported BGP Features

The RBFS supports the following BGP functions:

- Basic BGP Protocol
- Multiprotocol extension for BGP
- Multipath for iBGP and eBGP
- Four-byte AS numbers
- Nexthop Self or next-hop unchanged
- Fast external-failover
- Route reflection
- MD5 Authentication
- Generalized TTL Security Mechanism (GTSM)
- Route Refresh
- Advanced route refresh
- Route redistribution
- Multihop EBGP
- Route selection flexibility (always compare MED, ignore AS Path, and so on)
- Add path
- Hostname/Domain name
- Dynamic peers
- Community, Extended Community, and Large Community support
- 6PE Support
- Curated Upstream Path Selection

The statements and commands required to configure and verify the functioning of BGP features are described in this guide.

### MD5 Authentication

BGP supports the authentication mechanism using the Message Digest 5 (MD5) algorithm. When authentication is enabled, any Transmission Control Protocol (TCP) segment belonging to BGP exchanged between the peers is verified and



accepted only if authentication is successful. For authentication to be successful, both peers must be configured with the same password. If authentication fails, the BGP neighbor relationship is not established.

## **GTSM**

The Generalized TTL Security Mechanism (GTSM) protects a BGP session by evaluating the Time to Live (TTL) value contained in the IP header of incoming BGP packets.

TTL security is enabled using the `ttl-security` command on a single-hop BGP session. When TTL security is enabled on a BGP session the IP TTL values in packets is set to 255. To enable TTL security on a multihop BGP session, enable `ttl-security` and configure `ttl-limit` to match the expected TTL value.

For details about configuring GTSM, see the [Peer Group Configuration](#) section.

## **IPv6 Provider Edge (6PE)**

The Provider Edge (6PE) solution enables IPv6 communication over the MPLS IPv4 core network. IPv6 reachability information is associated with a label and transferred through MP-BGP(AFI: 2 SAFI:4). IPv4 mapped IPv6 address is used to encode the next-hop information. The edge nodes in the MPLS IPv4 core have to support both IPv4 and IPv6. The IPv6 Labeled Unicast routes received from the 6PE peer is considered as IPv6 unicast routes and installed in IPv6 Unicast FIB. The received Label is attached to the IPv6 data traffic at the Ingress node and tunneled through an MPLS tunnel(SR) to the egress node, the label identifies the IPv6 traffic, and the egress node would POP the label and forward the ipv6 traffic towards the destination.

## **Policies**

### **The Role of a Routing Policy**

Routing Policies are the rules that allow you to control and modify the default behavior of the routing protocols such as BGP and IS-IS. To use routing policies, you configure policies and then apply policies to peer groups or instances.

### **Attachment Points**

Policies are useful when they are applied to routes, for which they need to be

made known to routing protocols. In BGP, for example, there are several situations where policies can be used, the most common of these is defining import and export policy. The policy attachment point is the point in which an association is formed between a specific protocol entity, in this case, a BGP neighbor, and a specific named policy.

RtBrick supports attaching a BGP routing policy at two levels:

- Peer group address-family level
- Instance address-family level

In each case, you can apply the policy as an import or export policy and filter. As expected, import filters determine which routing updates are accepted and export filters determine which routes are advertised to other peers.

### **Policy Processing**

An import policy, when applied to an address family at the peer group level, examines all *incoming* routes from all BGP peers in the peer group, but only for that address family.

An export policy, when applied to an address family at the peer group level, examines all outgoing routes to all BGP peers in the peer group, but only for that address family.

At the instance level, routing policies that are applied to an address family can work as import or export policies, but for the instances as a whole.

An import policy, when applied to an address family at the instance level, examines all incoming routes before accepting the information only from global or default tables to other instances or VRF tables.

An export policy, when applied to an address family at the instance level, examines all outgoing routes before sending the information from the VRF to global, and then to the VPN table (default).

### **BGP Communities**

BGP communities are a way to tag routes with additional information that can be used for routing decisions and routing policies. A BGP community is a collection of destinations that share a common property. It allows you to apply actions to that

group of destinations as a whole, rather than to each member individually. BGP communities are used to provide an additional capability to tag routes and thereby, modify BGP routing policies.

Communities can influence routing decisions such as accept, reject, preference, and redistribution. RBFS allows various operations such as appending, modifying, or deleting communities as the route travels from one router to another. A BGP community is an optional attribute that can be tagged with a route. The AS path attribute contains community information, which is used to identify community members. It allows for route manipulation without requiring multiple route filters.

RBFS supports three types of BGP communities for implementing complex routing policies and effectively controlling traffic across diverse and large-scale networks.

### **Standard Communities**

These are used to control routing policies and are represented by a 32-bit number. They include well-known Communities such as no-export, no-advertise, and so on.

### **Extended Communities**

Extended Communities provide functionalities beyond what standard communities offer. They are represented by 64-bit number and are displayed as two 32-bit numbers. They include additional fields such as type and sub-type, providing more granularity and the ability to carry additional information. Types: These include route targets, route origin, and other specialized community types that extend.

### **Large Communities**

Represented as a 96-bit number, large communities consist of three 32-bit numbers separated by colons (for example, 64512:100:200). They provide space for tagging routes with extensive information and are easier to use in global policies. Large communities are used in large-scale deployments due to the larger addressing space.

### **Support for Allow As In**

The Allow AS In feature enables BGP routers to receive and process routes even if the routes carry the router's autonomous system number in the 'AS-Path' attribute. Usually, a BGP router discards routes if the 'AS-Path' attribute contains its autonomous system number to prevent loops. However, with the "Allow AS In"

feature, such routes can be accepted and routed to the destination without being rejected. You can specify the `allow-as-in` option value in the peer configuration. For example, if you specify the value '5', the router accepts BGP routes that contain its own AS number (in the AS path) up to 5 times.

## BGP Best Path Selection Algorithm

BGP routers typically receive multiple paths to the same destination. A BGP router forms a neighbor relationship by connecting to its neighbors and exchanging the routes, once the connection is established. The BGP route selection algorithm decides which is the best path to install in the IP routing table and to use for traffic forwarding.

### BGP Best Path Selection Algorithm

The algorithm eliminates all routes whose next hop is not reachable. Circular route resolution is considered for route resolution.

The algorithm for determining all the routes that have the same route prefix is as follows:

1. The first route selection is performed based on the lowest route source. Route from the local route source is always preferred over the received route. For example, when there is the same prefix route that is redistributed and received from a neighbor, the local (redistributed route) is always preferred. The locally learned route is preferred over the locally crossed or remote crossed route (in the case of VPN, a route might be learned locally in the VRF. The same prefix might be received from the remote as VPNv4. After importing into the VRF routing table, a locally learned route is preferred over the remote local crossed route).
2. Prefer the path with the highest local preference if the route source is the same. If a path does not have a local preference attribute (for example, it is received from an eBGP peer), then it is considered to have the local preference assigned in the given BGP instance. The `show bgp summary` command shows the local preference assigned in the system. This can be changed using the `set local-preference` value.
3. Prefer the route with the shortest AS path, if no route originated. If there is no `AS_PATH` attribute, then it is assumed to be of length 0. A single `AS_SET` is considered to be a length of 1.

4. Prefer the path with the lowest origin type, if the AS path length is the same as all the paths. The available three values include **IGP**, **EGP** and **Incomplete**. The lowest value is **IGP** and the highest value is **Incomplete**.
5. Prefer the path with the lowest Multi Exit Discriminator (MED), if the original codes are the same. (By default, MED values are only compared when routes are learned from the same AS. Routes without MED values are treated as if they have a MED value of **0**, which is the lowest and, therefore, always the most preferred value.)
6. Prefer external BGP learned routes over internal BGP routes at this point after comparing the route type (internal BGP and external BGP).
7. Prefer the path whose next hop is resolved through the IGP route with the lowest metric.
8. Prefer the length with a shorter CLUSTER length path. If the CLUSTER attribute is not present, the length is assumed to be **0**.
9. Prefer the path from the peer with the lowest router ID. For any path with an originator ID attribute, substitute the originator ID for the router ID during router ID comparison.
10. Prefer the lowest peer IP address as the tie-breaker, if the router-id is the same for both sessions. This is for BGP to make route selections in case of multiple peerings are used between the same routers.
11. If add path is enabled, then the same peer might advertise multiple paths for the same prefix. The path with a lower send path ID is preferred.

The BGP best path selection algorithm also provides a mechanism to discard paths that are not considered candidates for the best path. The following paths are discarded:

- The paths for which next-hops are not resolved.
- The paths originated from an eBGP neighbor if a local AS is shown in the **AS-PATH** attribute.
- If the BGP **enforce-first-as** attribute is enabled and the update does not contain the AS number of the neighbor as the first AS number in the **AS-SEQUENCE** attribute.
- The paths which are marked as **Received-only**.

## Support for Upstream BGP Route Export into VRFs of Peering Customers

This feature enables service providers to export or leak the upstream BGP routes into the VRFs for advertisement to peering customers. Certain peering customers usually do not require all the upstream BGP routes that the service provider receives. Instead, they want routes only from specific upstream providers. This feature gives peering customers more control over the upstream transit providers and they can choose their preferred upstream neighbor.

It allows service providers to selectively leak selected BGP routes from one instance to another without having to install the routes in the forwarding path in order to conserve the forwarding hardware resources. The leaked or exported routes do not get installed in peering customer VRFs. The feature offers an option to install the default route in the customer VRF that points to the upstream neighbor. It enables forwarding customer traffic towards the internet, connecting the customer site with external networks without requiring each specific route to be installed.

### 2.3.2. BGP Configuration

#### Configuration Hierarchy

The diagram illustrates the BGP configuration hierarchy. All BGP configuration is done within an instance, for example the default instance or a VPN service instance. The instance configuration hierarchy includes parameters required for BGP but not part of the BGP configuration hierarchy itself. The BGP instance configuration hierarchy includes parameters which are generic to the respective BGP instance. The sub-hierarchies include parameters which are specific to address families, peer groups, and peers.

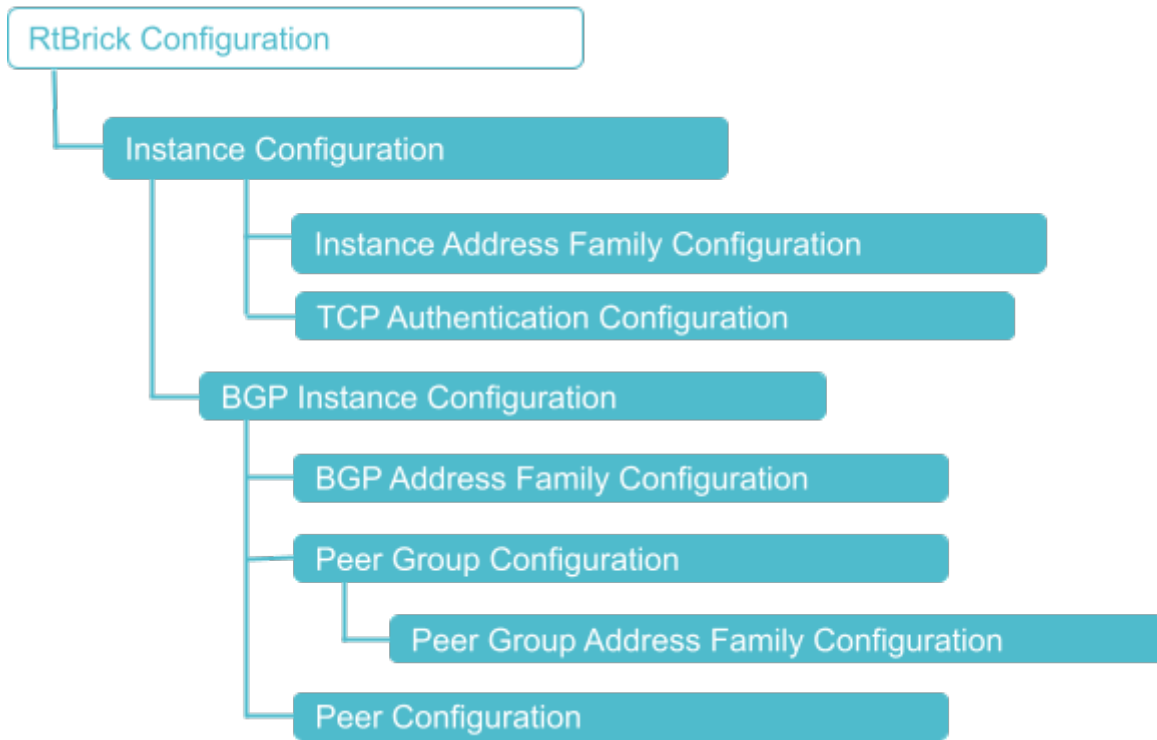

## Configuration Syntax and Commands

The following sections describe the BGP configuration syntax and commands.

### Instance Configuration

The instance configuration hierarchy includes parameters that are required for or used by BGP, but that are not part of the BGP protocol configuration hierarchy itself.

Route distinguishers and router IDs are configured directly at the instance hierarchy.

#### Syntax:

**set instance** <instance-name> <attribute> <value>

Attribute	Description
route-distinguisher <as-number ipv4-address:id>	<p>The route distinguisher (RD) uniquely defines routes within an IPv4 network. PE routers use route distinguishers to identify which VPN a packet belongs to. Supported formats are &lt;as-number:id&gt; or &lt;ipv4-address:id&gt;.</p> <div style="border-left: 1px solid black; padding-left: 10px; margin-top: 10px;">  <p>If you want to use the format &lt;as-number:id&gt; with a 4-byte ASN, specify it with an "L". For example, set instance services route-distinguisher 4200000000L:101</p> </div>
ipv4-router-id <ipv4-address>	The router ID of the routing instance.

### Example: Instance Identifier Configuration

```

supervisor@leaf1: cfg> show config instance services
{
  "rtbrick-config:instance": {
    "name": "services",
    "ipv4-router-id": "198.51.100.41",
    "route-distinguisher": "198.51.100.41:101",
    <...>
  }
}

```

### Address Families

At the instance address family hierarchy, you can enable or disable address families for the instance, and configure parameters like route targets.

Please note default settings depend on the instance. For the 'default' instance, the IPv4 and IPv6 unicast, multicast, and labeled unicast, as well as the MPLS unicast address families are enabled by default. For any non-default instance, no address family is enabled by default and needs to be enabled by configuration.

Syntax:

```
set instance <instance-name> address-family <afi> <safi> <attribute>
```



<value>

Attribute	Description
<afi>	Address family identifier (AFI). Supported values: ipv4, ipv6, or mpls
<safi>	Subsequent address family identifier (SAFI). Supported values: unicast, labeled-unicast, or multicast
route-target ( import   export ) <rt-value>	<p>Route targets (RT) are used to transfer routes between VPN instances. The RT identifies a subset of routes that should be imported to or exported from a particular VPN instance. You can configure a RT for importing or exporting routes or both.</p> <div style="border-left: 1px solid black; padding-left: 10px; margin-left: 20px;">  <p>If you want to use the format &lt;as-number:id&gt; with a 4-byte ASN, specify it with an "L". For example, set instance services address-family ipv4 unicast route-target export target:4200000000L:14</p> </div>
policy ( import   export ) <policy-name>	There are two attachment points for BGP policies. At this configuration hierarchy, you can attach import or export policies to the instance. These policies apply when routes are imported from the BGP protocol into the instance, or exported from the instance to the BGP protocol.

### Example: Instance Address Family Configuration

```

supervisor@leaf1: cfg> show config instance services
{
  "rtbrick-config:instance": {
    "name": "services",
    <...>
    "address-family": [
      {
        "afi": "ipv4",
        "safi": "unicast",
        "policy": {
          "export": "MY_V4_POLICY"
        },
        "route-target": {

```

```

        "import": "target:198.51.100.70:14",
        "export": "target:198.51.100.70:14"
    }
},
{
    "afi": "ipv6",
    "safi": "unicast",
    "policy": {
        "export": "MY_V6_POLICY"
    },
    "route-target": {
        "import": "target:198.51.100.70:16",
        "export": "target:198.51.100.70:16"
    }
}
],
<...>
}
}

```

### TCP Authentication Configuration

In the instance TCP authentication hierarchy, you can optionally enable MD5 or HMAC-SHA-1-96, HMAC-SHA-256-128, or AES-128-CMAC-96 authentication. Authentication is not configured for BGP directly but for the TCP sessions used by BGP. It is necessary to bind authentication to a peer in order for the authentication to work. For details about configuring a BGP Peer, see the section [Peer Configuration](#).



BGP TCP authentication is not backward compatible.

Syntax:

**set instance** <instance> **tcp authentication** <authentication-id> <attribute> <value>

Attribute	Description
<authentication-id>	Authentication identifier
type <type>	Authentication identifiers such as MD5
type <type>	Authentication identifiers such as MD5 or HMAC-SHA-1-96,HMAC-SHA-256-128 or AES-128-CMAC-96
key1-id <key1-id>	Key ID1 of the receiver
key1-encrypted-text <key1-encrypted-text>	Encrypted text of key1

Attribute	Description
key1-plain-text <key1-plain-text>	Plain text of key1
key2-id <key2-id>	Key ID2 of the receiver
key2-encrypted-text <key2-encrypted-text>	Encrypted text of key2
key2-plain-text <key2-plain-text>	Plain text of key2

### Example: BGP TCP Authentication Configuration

```
{
  "rtbrick-config:tcp": {
    "authentication": [
      {
        "authentication-id": "auth1",
        "type": "MD5",
        "key1-id": 10,
        "key1-encrypted-text": "$2784cfa7523916c8cc5dfeba83562cbb4",
        "key2-id": 20,
        "key2-encrypted-text": "$2e9bb845e3cfcf8173973029e5c1d90d6"
      }
    ]
  }
}
```

### BGP Instance Configuration

At this configuration hierarchy, you configure BGP protocol parameters which are generic to the BGP instance.

Syntax:

**set instance** <instance-name> **protocol bgp** <attribute> <value>

Attribute	Description
host-name <host-name>	The name of the BGP host, to a maximum of 64 characters
domain-name <domain-name>	The name of the BGP routing domain, to a maximum of 64 characters

Attribute	Description
enforce-first-as <enable   disable>	By default, the BGP routing process enforces the First AS feature. It discards updates received from an eBGP peer if the peer does not list its own AS number as the first segment in the AS_PATH BGP attribute. Disable the First AS feature to accept updates without the peer's source AS matching the first AS in the AS_PATH attribute.
local-as <as-number>	The AS number in four-byte format. The numbers allowed are from 1 to 4294967285.
local-preference <preference-value>	The local preference for the BGP protocol. The numbers allowed are from 0 to 4294967285. The local preference is used to select the exit path for an AS.
med <med-value>	The BGP Multi-Exit Discriminator (MED) value. The numbers allowed are from 0 to 4294967285. When an AS has multiple links to another AS, the MED value is used to determine the exit to use to reach the other AS.
protocol-preference (internal   external) <preference-value>	Protocol preference of routes learned by eBGP ('external'), iBGP ('internal'), or both. This preference is used to select routes learned from multiple protocols.
router-id <router-id>	Router identifier in IPv4 format
cluster-id <cluster-identifier>	The cluster ID associates routers in a group within a BGP routing instance. Routers belong to the same cluster if they have the same cluster-ID. The cluster ID is formatted as an IPv4 address.
timer hold-time <seconds>	Hold timer in seconds. The valid range is 5 to 65535.
timer keepalive <seconds>	Keep a live timer in seconds. The valid range is 5 to 65535.

### Example: BGP Instance Configuration

The following example shows some global BGP instance configuration attributes. The further BGP configuration like peer groups and peers is shown in the examples in the subsequent sections.

```

supervisor@spine1: cfg> show config instance default protocol bgp
{
  "rtbrick-config:bgp": {
    "cluster-id": "198.51.100.51",
    "domain-name": "rtbrick.com",
    "host-name": "spine1",
    "local-as": 4200000100,
    "local-preference": 50,
    "router-id": "198.51.100.51",
    "protocol-preference": {
      "internal": 180,
      "external": 20
    },
    "timer": {
      "hold-time": 30,
      "keepalive": 10
    },
    <...>
  }
}

```

## BGP Address Family Configuration

This configuration hierarchy refers to parameters that are specific to address families but generic to the BGP instance, as opposed to peer-group specific address families configuration. At this hierarchy, you can enable or disable address families for BGP, and configure various features specific to the address family.

RBFS offers support for a configurable route resolution policy. Initially, RBFS will attempt to resolve the BGP routes using primary resolve-next-hop afi/safi configuration. In case of failure, RBFS will then proceed to resolve the BGP routes using the secondary-next-hop afi/safi configuration.

Syntax:

```

set instance <instance-name> protocol bgp address-family <afi> <safi>
<attribute> <value>

```

Attribute	Description
<afi>	Address family identifier (AFI). Supported values: ipv4, or ipv6
<safi>	Subsequent address family identifier (SAFI). Supported values: unicast, labeled-unicast, vpn-unicast, multicast, or vpn-multicast

Attribute	Description
default-information originate <true   false>	Generate and distribute a default route information
download-count <count>	Forward packets over multiple paths, set maximum prefixes to use
multipath <number>	Enable load sharing among multiple BGP paths
retain-route-target (enable   disable)	Retain VPN routes for all route targets, by default this feature is enabled
resolve-nexthop afi <afi>	Address family to resolve the next-hop
resolve-nexthop safi <safi>	Sub-address family to resolve the next-hop
resolve-nexthop-secondary afi <afi>	Address family to resolve the next-hop when the primary route resolution fails
resolve-nexthop-secondary safi <safi>	Sub-address family to resolve the next-hop when the primary route resolution fails
redistribute <source>	Enable the redistribution feature to dynamically inject specific types of routes into the BGP protocol. Supported route sources are <b>direct</b> , <b>igmp</b> , <b>ipoe</b> , <b>isis</b> , <b>ospf</b> , <b>pim</b> , <b>ppp</b> , <b>static</b> , and <b>arp-nd</b> .
redistribute <source> policy <policy>	Attach a policy to the redistribution process
srgb base <value>	Segment Routing Global Block (SRGB) start label. The SRGB is the range of label values reserved for segment routing (SR). These values are assigned as segment identifiers (SIDs) to SR-enabled network nodes and have global significance throughout the routing domain. SRGB is supported for labeled unicast only.
srgb index <value>	Segment Routing Global Block (SRGB) index
srgb range <value>	Segment Routing Global Block (SRGB) label range

### Example 1: BGP Address Family Configuration with Segment Routing

```

supervisor@spine1: cfg> show config instance default protocol bgp
{
    
```

```

"rtbrick-config:bgp": {
  <...>
  "address-family": [
    {
      "afi": "ipv4",
      "safi": "vpn-unicast"
    },
    {
      "afi": "ipv6",
      "safi": "labeled-unicast",
      "srgb": {
        "base": 5000,
        "range": 1000,
        "index": 11
      }
    },
    {
      "afi": "ipv6",
      "safi": "unicast"
    },
    {
      "afi": "ipv6",
      "safi": "vpn-unicast"
    }
  ],
  <...>
}

```

## Example 2: BGP Address Family Configuration with Redistribution

```

supervisor@leaf1: cfg> show config instance services protocol bgp
{
  "rtbrick-config:bgp": {
    <...>
    "address-family": [
      {
        "afi": "ipv4",
        "safi": "unicast",
        "redistribute": [
          {
            "source": "direct"
          },
          {
            "source": "ppp"
          },
          {
            "source": "arp-nd"
          },
          {
            "source": "static"
          }
        ]
      },
      {
        "afi": "ipv6",
        "safi": "unicast",
        "redistribute": [

```

```

        "source": "direct"
    },
    {
        "source": "ppp"
    },
    {
        "source": "static"
    }
]
}
]
}
}
}

```

### Example 3: BGP Address Family Configuration with Redistribution and Redistribution Policy

```

supervisor@leaf1: cfg> show config instance services protocol bgp
{
  "rtbrick-config:bgp": {
    <...>
    "address-family": [
      {
        "afi": "ipv4",
        "safi": "unicast",
        "redistribute": [
          {
            "source": "direct"
            "policy": "MY_REDISTRIBUTION_POLICY"
          },
          {
            "source": "ppp"
          },
          {
            "source": "static"
          }
        ]
      },
      {
        "afi": "ipv6",
        "safi": "unicast",
        "redistribute": [
          {
            "source": "direct"
            "policy": "MY_REDISTRIBUTION_POLICY"
          },
          {
            "source": "ppp"
          },
          {
            "source": "static"
          }
        ]
      }
    ]
  }
}
}
}

```



## Example 4: BGP Address Family with Resolve Nexthop Configuration.

In the example below, RBFS would resolve the BGP routes in the IPv4 labeled-unicast RIB. If this fails, then the routes would be resolved in IPv4 unicast RIB.

```

supervisor@leaf1: cfg> show config instance default protocol bgp address-family
ipv4 unicast
{
  "rtbrick-config:address-family": [
    {
      "afi": "ipv4",
      "safi": "unicast",
      "resolve-nexthop": {
        "afi": "ipv4",
        "safi": "labeled-unicast"
      },
      "resolve-nexthop-secondary": {
        "afi": "ipv4",
        "safi": "unicast"
      }
    }
  ]
}

```

## Peer Group Configuration

### Peer Groups

In BGP, neighbor peers with the same update policies can be grouped to simplify the initial configuration and updates. Peers share the same policies such as route maps, distribution lists, filter lists, update sources, and so on, so peer groups only need one configuration statement for these values.

Syntax:

```
set instance <instance-name> protocol bgp peer-group <peer-group-name>
<attribute> <value>
```

Attribute	Description
local-as <as-number>	Local AS number for the peer group
remote-as <as-number>	Remote AS number for the peer group
any-as <true   false>	Enable dynamic AS negotiation for this peer group

Attribute	Description
ebgp-multihop <hop-count>	By default, the maximum number of hops between eBGP peers is 1 (direct connection). This hop count overrides the default behavior allowing connectivity between eBGP peers not directly connected.
link-local-nexthop-only <true   false>	Enable BGPv6 peerings using the IPv6 link-local addresses
no-prepend <true   false>	Do not prepend the local AS for advertisements to the peer
replace-as <true   false>	Prepend only the local AS for advertisements to the peer
ttl-security <enable   disable>	Enables or disalbes Generalized TTL Security Mechanism (GTSM).
ttl-limit <ttl-limit>	Specifies the minimum TTL value of packets from the BGP neighbor for TTL Security. The valid range is 1 to 255.

## Address Families

At this configuration hierarchy, you can enable the address families that shall be supported for the group peers, and enable features specific to the address family. By default, BGP neighbor sessions support the IPv4 unicast and multicast address families.

Syntax:

```
set instance <instance-name> protocol bgp peer-group <peer-group-name>
address-family <afi> <safi> <attribute> <value>
```

Attribute	Description
<afi>	Address family identifier (AFI). Supported values: ipv4, or ipv6
<safi>	Subsequent address family identifier (SAFI). Supported values: unicast, labeled-unicast, vpn-unicast, multicast, or vpn-multicast

Attribute	Description
add-path	Negotiate additional path capabilities with these peers, so that more than one path can be active to the peers in the group
default-information originate <true   false>	Generate and advertise a default route to peers in the group
extended-nexthop	Enable extended-next-hop encoding for BGP peer groups to allow the transfer of IPv4 prefixes over an IPv6 connection
nexthop-self <true   false>	Set the advertised BGP nexthop to yourself, this is the default for eBGP
nexthop-unchanged <true   false>	Do not modify the advertised BGP nexthop, this is the default for iBGP
update-nexthop ( ipv4-address   ipv6-address ) <address>	BGP nexthop address for routes advertised to this peer group
remove-private-as <true   false>	Remove private AS numbers from routes advertised to group peers
route-reflect-client <true   false>	Configure this peer as a route reflector client
policy ( import   export ) <policy-name>	Apply a routing policy to the peer group

### Example 1: BGP Peer Group Configuration

```

supervisor@leaf1: cfg> show config instance default protocol bgp peer-group spine
{
  "rtbrick-config:peer-group": {
    "pg-name": "spine",
    "link-local-nexthop-only": "true",
    "remote-as": 4200000100,
    "address-family": [
      {
        "afi": "ipv4",
        "safi": "vpn-unicast",
        "extended-nexthop": "true",
        "update-nexthop": {
          "ipv6-address": "2001:db8:0:19::"
        }
      },
      {
        "afi": "ipv6",

```

```
    "safi": "labeled-unicast"
  },
  {
    "afi": "ipv6",
    "safi": "unicast"
  },
  {
    "afi": "ipv6",
    "safi": "vpn-unicast",
    "update-nexthop": {
      "ipv6-address": "2001:db8:0:19::"
    }
  }
]
}
```

## Example 2: GTSM Configuration

```
{
  "rtbrick-config:peer-group": [
    {
      "pg-name": "ipv4_bgp",
      "remote-as": 4200000100,
      "ttl-security": "enable",
      "ttl-limit": 253,
      "address-family": [
        {
          "afi": "ipv4",
          "safi": "unicast"
        },
        {
          "afi": "ipv6",
          "safi": "unicast"
        }
      ]
    }
  ]
}
```

### Maximum Prefix Limit

The BGP Maximum Prefix Limit feature enables you to set a limit for the maximum number of prefixes that a BGP router can receive from its peer router. If a BGP router receives prefixes that exceed the defined limit threshold, the BGP session gets reset and the session goes idle for a pre-defined period.

You can define a period as idle timeout so that the BGP peering gets re-established automatically after the specified time. If you do not specify the idle timeout, the BGP peering does not get re-established until or unless you execute the `clear bgp neighbor` command.

Before getting into inactive or idle mode, the router sends a notification message to the peer router about the exceeded threshold with the error code and the sub-code.

You can configure prefix limits for a peer group.

Syntax:

```
set instance <instance-name> protocol bgp peer-group <peer-group-name>
address-family <afi> <safi> prefix-limit <attribute> <value>
```

Attribute	Description
<afi>	Address family identifier (AFI). Supported values: ipv4, or ipv6
<safi>	Subsequent address family identifier (SAFI). Supported values: unicast, labeled-unicast, vpn-unicast, or vpn-multicast
count <count>	Number of maximum prefixes that the peer router is allowed to send. The default value is 0. It means no value is configured for prefix limit.
idle-timeout <idle-timeout>	Idle or inactive time after the maximum limit is reached (in minutes). The allowed range is 1 - 2400 min. The default is <b>Forever</b> .

### Example: BGP Maximum Prefix Limit Configuration

```
supervisor@L1-STD-2-2002>bm14-tst.fsn.rtbrick.net: cfg> show config instance
default protocol bgp peer-group PE2 address-family ipv4 unicast
{
  "rtbrick-config:address-family": [
    {
      "afi": "ipv4",
      "safi": "unicast",
      "prefix-limit": {
        "count": 100,
        "idle-timeout": 5
      }
    }
  ]
}
```

## Configure Upstream BGP Route Export into VRFs of Peering Customers

For peering customers, it is required to select and install specific upstream routes in their own dedicated routing tables (VRFs). To achieve this, the routes from a single upstream peer must be distributed to multiple RIBs, one for each customer-specific VRF.

You can configure the Upstream BGP Route Export into VRFs of peering customers.

### Syntax:

```
set instance <instance-name> protocol bgp peer-group <peer-group-name>
address-family <afi> <safi> export-rib <name>
```

Attribute	Description
<instance-name>	Name of the routing instance.
<peer-group-name>	Name of the peer group.
<afi>	Address family identifier (AFI). Supported values: ipv4, or ipv6
<safi>	Subsequent address family identifier (SAFI). Supported values: unicast, labeled-unicast, vpn-unicast, or vpn-multicast
export-rib	Defines in which routing tables (RIBs) the routes from this peer will be installed. The option indicates that the routes learned from the BGP peer are to be installed in multiple RIBs.
peer-default-route	It specifies the default route that is to be installed in the customer's routing table.

### Example: BGP support for Curated Route Export Configuration

```
supervisor@rtbrick.net: cfg> show config instance default protocol bgp peer-group
PE2 address-family ipv4 unicast
{
  "rtbrick-config:address-family": [
    {
      "afi": "ipv4",
      "safi": "unicast",
      "peer-default-route": [
        "CE1",
        "CE2",
        "CE3"
      ]
    }
  ]
}
```

```

    ],
    "export-rib": [
      {
        "instance": "CE1"
      },
      {
        "instance": "CE2"
      },
      {
        "instance": "CE3"
      }
    ]
  ]
}

```

## Peer Configuration

Once peer groups have been defined, BGP peers can be configured at the peer configuration hierarchy. A peer can be specified by address, or by interface when using IPv6 auto-discovered neighbors and link-local addresses. Furthermore, it is possible to configure TCP authentication and bind it to a peer.

Syntax to configure a BGP peer by address:

```
set instance <instance-name> protocol bgp peer ( ipv4 | ipv6) <peer-address>
<update-source> peer-group <peer-group>
```

Syntax to configure a BGP peer using IPv6 link-local addresses:

```
set instance <instance-name> protocol bgp peer interface <name> peer-group
<peer-group>
```

Syntax to configure TCP Authentication for BGP peers:

```
set instance <instance-name> protocol bgp peer (ipv4 | ipv6) <peer-address>
<update-source> authentication-id <authentication-id>
```

Attribute	Description
interface <name>	Enable BGP peer using IPv6 link-local addresses
ipv4 <peer-address>	IPv4 address of a BGP peer
ipv6 <peer-address>	IPv6 address of a BGP peer
allow-as-in <value>	Specify the value for allow-as-in. Allowed range of value 1 - 10.

Attribute	Description
<update-source>	Local IP address to be used for the peering
peer-group <peer-group>	Assign the peer to a peer group
deactivate	Deactivate a configured peer
authentication-id <authentication-id>	Authentication identifier

### Example 1: BGP peer specified by IP addresses

```

supervisor@rtbrick: cfg> show config instance default protocol bgp peer

{
  "rtbrick-config:peer": {
    "ipv4": [
      {
        "peer-address": "198.51.100.82",
        "update-source": "198.51.100.81",
        "peer-group": "spine"
      }
    ]
  }
}

```

### Example 2: BGP peer using IPv6 link-local addresses

```

supervisor@rtbrick: cfg> show config instance default protocol bgp peer

{
  "rtbrick-config:peer": {
    "interface": [
      {
        "name": "ifl-0/0/1/1",
        "peer-group": "spine"
      }
    ]
  }
}

```

### Example 3: BGP peer authentication

```

supervisor@rtbrick: cfg> show config instance default protocol bgp peer

{
  "rtbrick-config:peer": {
    "interface": [
      {
        "name": "ifl-0/0/1/1",
        "authentication-id": "auth1",

```



```

    "peer-group": "spine"
  }
]
}
}

```

## Sample Configuration

### Example 1: BGP Configuration of a Spine Switch (Default Instance only)

```

{
  "ietf-restconf:data": {
    "rtbrick-config:instance": [
      {
        "name": "default",
        "ipv4-router-id": "198.51.100.51",
        "protocol": {
          "bgp": {
            "domain-name": "rtbrick.com",
            "host-name": "spine1",
            "local-as": 4200000100,
            "address-family": [
              {
                "afi": "ipv4",
                "safi": "vpn-unicast"
              },
              {
                "afi": "ipv6",
                "safi": "labeled-unicast",
                "srgb": {
                  "base": 5000,
                  "range": 1000,
                  "index": 11
                },
                "redistribute": [
                  {
                    "source": "direct"
                  }
                ]
              },
              {
                "afi": "ipv6",
                "safi": "unicast",
                "redistribute": [
                  {
                    "source": "direct"
                  }
                ]
              },
              {
                "afi": "ipv6",
                "safi": "vpn-unicast"
              }
            ],
            "peer": {
              "interface": [
                {

```

```

        "name": "ifl-0/1/1/1",
        "authentication-id": "auth1",
        "peer-group": "spine"
    },
    {
        "name": "ifl-0/2/1/1",
        "peer-group": "leaf1"
    },
    {
        "name": "ifl-0/2/2/1",
        "peer-group": "leaf2"
    }
]
},
"peer-group": [
    {
        "pg-name": "leaf1",
        "link-local-nextthop-only": "true",
        "remote-as": 4200000201,
        "address-family": [
            {
                "afi": "ipv4",
                "safi": "vpn-unicast",
                "extended-nextthop": "true",
                "nextthop-unchanged": "true"
            },
            {
                "afi": "ipv6",
                "safi": "labeled-unicast"
            },
            {
                "afi": "ipv6",
                "safi": "unicast"
            },
            {
                "afi": "ipv6",
                "safi": "vpn-unicast",
                "nextthop-unchanged": "true"
            }
        ]
    },
    {
        "pg-name": "leaf2",
        "link-local-nextthop-only": "true",
        "remote-as": 4200000202,
        "address-family": [
            {
                "afi": "ipv4",
                "safi": "vpn-unicast",
                "extended-nextthop": "true",
                "nextthop-unchanged": "true"
            },
            {
                "afi": "ipv6",
                "safi": "labeled-unicast"
            },
            {
                "afi": "ipv6",
                "safi": "unicast"
            },
            {

```

```

        "afi": "ipv6",
        "safi": "vpn-unicast",
        "nexthop-unchanged": "true"
      }
    ]
  },
  {
    "pg-name": "spine",
    "link-local-nexthop-only": "true",
    "remote-as": 4200000100,
    "address-family": [
      {
        "afi": "ipv4",
        "safi": "vpn-unicast",
        "extended-nexthop": "true"
      },
      {
        "afi": "ipv6",
        "safi": "labeled-unicast",
        "nexthop-self": "true"
      },
      {
        "afi": "ipv6",
        "safi": "unicast",
        "nexthop-self": "true"
      },
      {
        "afi": "ipv6",
        "safi": "vpn-unicast"
      }
    ]
  }
]
}

```

## Example 2: BGP Configuration of a Leaf Switch with one VPN Instance

```

{
  "ietf-restconf:data": {
    "rtbrick-config:instance": [
      {
        "name": "default",
        "ipv4-router-id": "198.51.100.53",
        "protocol": {
          "bgp": {
            "domain-name": "rtbrick.com",
            "host-name": "leaf1",
            "local-as": 4200000201,
            "address-family": [
              {
                "afi": "ipv4",
                "safi": "vpn-unicast"
              },
            ],
          }
        }
      }
    ]
  }
}

```

```

        "afi": "ipv6",
        "safi": "labeled-unicast",
        "srgb": {
            "base": 5000,
            "range": 1000,
            "index": 13
        },
        "redistribute": [
            {
                "source": "direct"
            }
        ]
    },
    {
        "afi": "ipv6",
        "safi": "unicast",
        "redistribute": [
            {
                "source": "direct"
            }
        ]
    },
    {
        "afi": "ipv6",
        "safi": "vpn-unicast"
    }
],
"peer": {
    "interface": [
        {
            "name": "ifl-0/1/1/1"
            "authentication-
id": "auth1",
            "peer-group": "spine"
        },
        {
            "name": "ifl-0/1/2/1",
            "peer-group": "spine"
        }
    ]
},
"peer-group": [
    {
        "pg-name": "spine",
        "link-local-nextthop-only": "true",
        "remote-as": 4200000100,
        "address-family": [
            {
                "afi": "ipv4",
                "safi": "vpn-unicast",
                "extended-nextthop": "true",
                "update-nextthop": {
                    "ipv6-address": "2001:db8:0:19::"
                }
            }
        ],
        {
            "afi": "ipv6",
            "safi": "labeled-unicast"
        },
        {
            "afi": "ipv6",
            "safi": "unicast"
        }
    ]
}

```

```

        },
        {
            "afi": "ipv6",
            "safi": "vpn-unicast",
            "update-next-hop": {
                "ipv6-address": "2001:db8:0:19::"
            }
        }
    ]
}
],
}
},
{
    "name": "services",
    "ipv4-router-id": "198.51.100.41",
    "route-distinguisher": "198.51.100.41:101",
    "address-family": [
        {
            "afi": "ipv4",
            "safi": "unicast",
            "policy": {
                "export": "MY_V4_POLICY"
            },
            "route-target": {
                "import": "target:198.51.100.70:14",
                "export": "target:198.51.100.70:14"
            }
        },
        {
            "afi": "ipv6",
            "safi": "unicast",
            "policy": {
                "export": "MY_V6_POLICY"
            },
            "route-target": {
                "import": "target:198.51.100.70:16",
                "export": "target:198.51.100.70:16"
            }
        }
    ],
    "protocol": {
        "bgp": {
            "domain-name": "rtbrick.com",
            "host-name": "leaf1",
            "local-as": 65003,
            "address-family": [
                {
                    "afi": "ipv4",
                    "safi": "unicast",
                    "redistribute": [
                        {
                            "source": "direct"
                        },
                        {
                            "source": "ppp"
                        },
                        {
                            "source": "static"
                        }
                    ]
                }
            ]
        }
    }
}

```

```
        ],
      },
      {
        "afi": "ipv6",
        "safi": "unicast",
        "redistribute": [
          {
            "source": "direct"
          },
          {
            "source": "ppp"
          },
          {
            "source": "static"
          }
        ]
      }
    ]
  }
}
```

## 2.3.3. BGP Operational Commands

### BGP Show Commands

The BGP show commands provide detailed information about the BGP protocol operation and BGP routes.

#### BGP Summary

This command displays BGP protocol parameters like attributes or timers that are generic to the BGP instance.

#### Syntax:

```
show bgp summary <option>
```

Option	Description
-	Without any option, the commands displays the information for all instances.
instance <instance-name>	BGP summary information for the given instance.

Example: BGP summary for the default instance

```

supervisor@rtbrick: op> show bgp summary instance default
Instance: default
  General information
    Hostname: PE1, Domain name:
    Local AS: 1000, Version: 4
    Local preference: 100, eBGP Protocol preference: 20, iBGP Protocol preference:
200
    Router ID: 198.51.100.102, Cluster ID: 198.51.100.102
  Capabilities
    Route refresh: True, AS4: True, Graceful restart: False, L2VPN EVPN:True L2VPN
VPLS:True
  Best route selection
    Always compare MED: False, Ignore as path: False
    Ignore local preference: False, Ignore origin: False
    Ignore MED: False, Ignore route source: False
    Ignore router ID: False, Ignore uptime: True
    Ignore cluster length: False, Ignore peer IP: False
    Route select parameter: 0
  Timers
    Connect retry: 30s, Keepalive: 30s, Holdtime: 90s
  Statistics
    Peers configured: 1, Peers auto discovery: 0
    Peers in idle           : 0
    Peers in connect        : 0
    Peers in active         : 0
    Peers in opensent       : 0
    Peers in openconfirm    : 0
    Peers in established    : 1

```

## BGP Peer

The 'show bgp peer' commands display information on BGP peers.

Syntax:

**show bgp peer** <option> ...

Option	Description
-	Without any option, the commands display all BGP peers in all instances in a summary table format.
detail	Detailed information on all BGP peers in all instances in a list view.
<peer-name>	Detailed information on the peer with the given name.
history	Displays BGP peer history information such as the peer state down reasons.
history <peer-address>	Displays BGP peer history information such as the peer state down reasons for a specified peer.

Option	Description
address <peer-address>	Detailed information on the peer with the given IP address.
instance <instance-name>	Summary of all BGP peers in the given instance.
instance <instance-name> detail	Detailed information on all BGP peers in the given instance.
instance <instance-name> detail <peer-name>	Detailed information on the peer with the given name in the given instance.
instance <instance-name> detail address <peer-address>	Detailed information on the peer with the given IP address in the given instance.
statistics	Received and sent BGP prefixes per AFI/SAFI for all peers in all instances.
statistics peer <peer-name>	Received and sent BGP prefixes per AFI/SAFI for the peer with the given name.
statistics peer address <peer-address>	Received and sent BGP prefixes per AFI/SAFI for the peer with the given IP address.
statistics instance <instance-name> peer <peer-name>	Received and sent BGP prefixes per AFI/SAFI for the peer with the given name in the given instance.
statistics instance <instance-name> peer address <peer-address>	Received and sent BGP prefixes per AFI/SAFI for the peer with the given IP address in the given instance.



Although 6PE routes are labeled, they are handled as unicast routes, and therefore will be shown as IPv6 unicast in the BGP peer statistics.

### Example 1: BGP Peer Summary View

```

supervisor@rtbrick: op> show bgp peer
Instance: default
  Peer                               Remote AS   State           Up/Down Time
  PfxRcvd                             PfxSent
  PE2                                  2000        Established
  11d:22h:18m:30s                       12          20
Instance: default
  Peer                               Remote AS   State           Up/Down Time
  PfxRcvd                             PfxSent
  
```



CE1		65535	Established
6d:02h:28m:02s	2	2	
CE1		65535	Established
6d:02h:27m:45s	2	2	

### Example 2: BGP Peer Detail View

```

supervisor@rtbrick: op> show bgp peer detail
Peer: PE2, Peer IP: 198.51.100.39, Remote AS: 2000, Local: 198.51.100.29, Local
AS: 1000, Any AS: False
  Type: ebgp, State: Established, Up/Down Time: 11d:22h:18m:48s, Reason: Cease,
Sub-Code: Admin shutdown
  Discovered on interface: -
  Last transition: Thu Nov 19 05:33:28 GMT +0000 2020, Flap count: 1
  Peer ID      : 198.51.100.106, Local ID  : 198.51.100.102
  Instance    : default, Peer group: to_pe2
  6PE enabled : False
  Timer values:
    Peer keepalive : 30s, Local keepalive: 30s
    Peer holddown  : 90s, Local holddown  : 90s
    Connect retry  : 30s
  Timers:
    Connect retry timer : 0s
    Keepalive timer     : expires in 1s 488011us
    Holddown timer      : expires in 1m 15s 85437us
  NLRIs:
    Sent      : ['ipv6-unicast', 'ipv4-vpn-unicast', 'ipv6-vpn-unicast',
'ipv6-labeled-unicast']
    Received  : ['ipv6-unicast', 'ipv6-labeled-unicast', 'ipv4-vpn-unicast',
'ipv6-vpn-unicast']
    Negotiated : ['ipv6-unicast', 'ipv6-labeled-unicast', 'ipv4-vpn-unicast',
'ipv6-vpn-unicast']
  Capabilities:
    Addpath sent           : None
    Addpath received      : None
    Addpath negotiated     : None
    Extended nexthop sent : ['ipv4-vpn-unicast']
    Extended nexthop received : ['ipv4-vpn-unicast']
    Extended nexthop negotiated : ['ipv4-vpn-unicast']
  Capabilities:
    Feature      Sent      Received      Negotiated
    Route refresh True      True         True
    4 byte AS    True      True         True
    Graceful restart False     False        False
    Link local only False     False        False
  Prefix Limit:
  End of RIB:
    Address family      Sent      Received
    IPv4 unicast        never     never
    IPv4 labeled-unicast never     never
    IPv6 unicast        Thu Nov 19 05:33:30 GMT +0000 2020 Thu Nov 19
05:33:30 GMT +0000 2020
    IPv6 labeled-unicast Thu Nov 19 05:33:30 GMT +0000 2020 Thu Nov 19
05:33:30 GMT +0000 2020
    IPv4 VPN-unicast    Thu Nov 19 05:33:30 GMT +0000 2020 Thu Nov 19
05:33:30 GMT +0000 2020
    IPv6 VPN-unicast    Thu Nov 19 05:33:30 GMT +0000 2020 Thu Nov 19
05:33:30 GMT +0000 2020
    IPv4 VPN-multicast never     never

```

```

Message stats:
  Session stats:
    Direction  Open           Update           Keepalive        Notify           Route
refresh
  Input       1             38              41196           0                0
  Output      1             22              41207           0                0
  Total stats:
  Input       2             48              44618           1                0
  Output      3             32              44624           0                0
  Route stats:
  Address family      Received      Sent
  IPv4 unicast        0             0
  IPv4 labeled-unicast 0             0
  IPv6 unicast        2             3
  IPv6 labeled-unicast 2             3
  IPv4 VPN-unicast    4             7
  IPv6 VPN-unicast    4             7
  IPv4 multicast      0             0
  IPv4 VPN-multicast  0             0
<...>

```

### Example 3: BGP Peer Statistics

```

supervisor@rtbrick: op> show bgp peer statistics instance default peer PE2
Instance: default
Peer      AFI      SAFI      PfxRcvd  PfxSent
PE2       ipv4     unicast   0         0
          ipv4     labeled-unicast 0         0
          ipv6     unicast   2         3
          ipv6     labeled-unicast 2         3
          ipv4     vpn-unicast 4         7
          ipv6     vpn-unicast 4         7
          ipv4     multicast  0         0
          ipv4     vpn-multicast 0         0

```

### Example 4: BGP Peer history for a specified peer

```

supervisor@rtbrick.net: op> show bgp peer history peer address 192:168::40
Instance: ip2vrf
Peer Address      Source Address      Type      Last
Reset Reason
192:168::40      192:168:5::20      FSM Error  FSM
Error, Sub-Code: Unexpected message in OpenSent State

```

## BGP Peer Group

The 'show bgp peer-group' commands display parameters like BGP attributes that are specific to the respective peer groups.

Syntax:

**show bgp peer-group** <option> ...

Option	Description
-	Without any option, the commands display information on all peer groups in all instances.
<peer-group-name>	Information on the peer group with the given name.
instance <instance-name>	All peer groups in the given instance.
instance <instance-name> <peer-group-name>	Information on the peer group with the given name in the given instance.

**Example: BGP Peer Group**

```

supervisor@rtbrick: op> show bgp peer-group to_pe2
Instance: default
Peer group name      : to_pe2
Remote AS            : 2000
Import rule          : None
Export rule          : None
Remove AS            : None
Nexthop self         : None
Multipath iBGP       : None
Multipath eBGP       : None
Client-to-Client     : None
Add path             : None
eBGP multihop        : None
Hop (TTL)            : None
Any AS               : None
Update VPNv4 NH      : None
Update MVPN NH       : None
    
```

**BGP FIB**

The 'show bgp fib' commands display the BGP forwarding table. In contrast to the 'show bgp rib' commands, the output of the 'show bgp fib' commands includes only the selected routes. The BGP route selection occurs between the RIB and the FIB.

Syntax:

**show bgp fib** <option> ...

Option	Description
-	Without any option, the commands display the BGP forwarding table for all address families and all instances in a summary table format.

Option	Description
<afi>	BGP forwarding table summary for the given address family (AFI), all sub-address families and all instances. Supported AFI values are 'ipv4' and 'ipv6'.
<afi> <safi>	BGP forwarding table summary for the given address family (AFI) and sub-address family (SAFI), and all instances. Supported SAFI values are 'unicast', 'labeled-unicast', 'vpn-multicast', and 'vpn-unicast'.
<afi> <safi> detail	Detailed list view of the BGP forwarding table for the given address family (AFI) and sub-address family (SAFI), and all instances.
<afi> <safi> <prefix>	BGP forwarding table entry for the given prefix and all instances.
<afi> <safi> instance <instance-name>	BGP forwarding table summary for the given AFI, SAFI, and instance.
<afi> <safi> instance <instance-name> detail	Detailed list view of BGP forwarding table for the given AFI, SAFI, and instance.
<afi> <safi> instance <instance-name> <prefix>	BGP forwarding table entry for the given prefix and instance.

Example 1: Summary view of the BGP FIB for IPv6, all SAFIs and all instances

```

supervisor@rtbrick: op> show bgp fib ipv6
Instance: default, AFI: ipv6, SAFI: unicast
  Prefix                Preference    Out Label
Next Hop
  2001:db8:0:2::/32      20           -
198.51.100.39
  2001:db8:0:2::/32      20           -
198.51.100.39
Instance: services, AFI: ipv6, SAFI: unicast
  Prefix                Preference    Out Label
Next Hop
  2001:db8:0:6::/32      200          -
2001:db8:0:4::
Instance: default, AFI: ipv6, SAFI: labeled-unicast
  Prefix                Preference    Out Label
Next Hop
  2001:db8:0:2::/32      20           2003
198.51.100.39
  2001:db8:0:2::/32      20           2003
198.51.100.39
Instance: default, AFI: ipv6, SAFI: vpn-unicast
  Prefix                Preference    Out Label
Next Hop

```

2001:db8:0:5::/32	200	20003,bos:1
2001:db8:0:6::/32	200	20003,bos:1
2001:db8:0:8::/32	200	20003,bos:1
2001:db8:0:9::/32	20	20006,bos:1
2001:db8:0:7::		
2001:db8:0:10::/32	20	20006,bos:1
2001:db8:0:7::		
2001:db8:0:11::/32	20	20006,bos:1
2001:db8:0:7::		
2001:db8:0:12::/32	20	20006,bos:1
2001:db8:0:7::		

Example 2: Detailed view of the BGP FIB for IPv6 VPN unicast routes in the default instances

```

supervisor@rtbrick: op> show bgp fib ipv6 vpn-unicast instance default detail
Instance: default, AFI: ipv6, SAFI: vpn-unicast
  Prefix: 2001:db8:0:5::/32
    Route source: bgp-local, Send path ID: 405188370, Received path ID: None, Path
    hash: None
    AS path: None, Originator ID: None, Origin: Incomplete
    Community: None
    Extended community: ['target:198.51.100.93:2']
    Large community: None
    Cluster list: None
    IGP metric: None, Local preference: 100, Multi exit discriminator: 0
    Preference: 200, External route: None, Readvertised route: None
    Route up: None
    Next hop: 12.0.0.2, Label: 20003,bos:1
  Prefix: 2001:db8:0:6::/32
    Route source: bgp-local, Send path ID: 2400017309, Received path ID: None,
    Path hash: None
    AS path: None, Originator ID: None, Origin: Incomplete
    Community: None
    Extended community: ['target:198.51.100.93:2']
    Large community: None
    Cluster list: None
    IGP metric: None, Local preference: 100, Multi exit discriminator: None
    Preference: 200, External route: None, Readvertised route: None
    Route up: None
    Next hop: 12.0.0.2, Label: 20003,bos:1
    
```

## BGP RIB-in

This command displays the total routes.

Syntax:

**show bgp rib-in** <option> ...

Option	Description
-	Without any option, the command displays information on the received BGP routing table on all instances in a summary table format.
<afi>	BGP routing table summary for the given address family (AFI), all sub-address families and all instances. Supported AFI values are 'ipv4' and 'ipv6'.
<afi> <safi>	BGP routing table summary for the given address family (AFI) and sub-address family (SAFI), and all instances. Supported SAFI values are 'labeled-unicast', 'unicast', 'vpn-multicast', and 'vpn-unicast'.
<afi> <safi> detail	Detailed list view of the BGP routing table for the given address family (AFI) and sub-address family (SAFI), and all instances.
<afi> <safi> <prefix>	BGP routing table entry for the given prefix and all instances.
<afi> <safi> instance <instance-name>	BGP routing table summary for the given AFI, SAFI, and instance.
<afi> <safi> instance <instance-name> detail	Detailed list view of BGP routing table for the given AFI, SAFI, and instance.
<afi> <safi> instance <instance-name> <prefix>	BGP routing table entry for the given prefix and instance.
<afi> <safi> community <community-name>	BGP community details for the given AFI, SAFI, and instance.
<afi> <safi> error	BGP route with error status for the given AFI, SAFI, and instance.
<afi> <safi> peer <name> / peer address <ip>	Peer name or address
import	Summary information for imported routes.

Example 1: Summary view of the BGP rib-in.

```

supervisor@rtbrick: op> show bgp rib-in
Flags: & - Imported, ! - Error
Instance: ip2vrf, AFI: ipv4, SAFI: unicast
  Hostname: Local, Peer IP: 0.0.0.0
  Source IP: 0.0.0.0, Total routes: 10
  Prefix      Next Hop      MED      Lpref      AS
  
```

```

Path
198.51.100.75/24          198.51.100.93          -          100          -
198.51.100.76/24          198.51.100.94          -          100          -
198.51.100.77/24          198.51.100.99          -          100          -
198.51.100.78/24          198.51.100.94          -          100          -
198.51.100.79/24          198.51.100.99          -          100          -
198.51.100.82/24          198.51.100.94          -          100          -
198.51.100.93/24          198.51.100.93          -          100          -
198.51.100.94/24          198.51.100.94          -          100          -
198.51.100.99/24          198.51.100.99          -          100          -
198.51.100.99/24          198.51.100.99          -          100          -
Instance: default, AFI: ipv4, SAFI: vpn-unicast
  Hostname: Local, Peer IP: 0.0.0.0
  Source IP: 0.0.0.0, Total routes: 4
  Prefix          Next Hop          MED          Lpref          AS
Path
198.51.100.14/24      2001:db8:0:1::/32      0          -
4200000004
198.51.100.17/24      2001:db8:0:1::/32      0          -
4200000004
198.51.100.16/24      2001:db8:0:1::/32      0          -
4200000004
    
```

Example 2: Summary view of the BGP rib-in for IPv4, with error flag.

```

supervisor@rtbrick>rtbrick.net: op> show bgp rib-in
Flags: & - Imported, ! - Error
Instance: default, AFI: ipv4, SAFI: unicast
  Hostname: Local, Peer IP: 0.0.0.0
  Source IP: 0.0.0.0, Total routes: 4
  Flags Prefix          Next Hop          MED          Lpref          AS Path
  12.0.0.0/24          -          0          100          -
  12.1.0.0/24          -          0          100          -
  192.168.0.10/32      -          0          100          -
  192.168.0.11/32      -          0          100          -
  Hostname: P1, Peer IP: 12.0.0.2
  Source IP: 12.0.0.1, Total routes: 4
  Flags Prefix          Next Hop          MED          Lpref          AS Path
  12.0.0.0/24          12.0.0.2          0          -          4200000002
  12.1.0.0/24          12.0.0.2          0          -          4200000002
  192.168.0.20/32      12.0.0.2          0          -          4200000002
  192.168.0.21/32      12.0.0.2          0          -          4200000002
    
```

Example 3: Summary view of the BGP rib-in for IPv4, all SAFIs and all instances

```

supervisor@rtbrick: op> show bgp rib-in ipv4
Flags: & - Imported, ! - Error
Instance: ip2vrf, AFI: ipv4, SAFI: unicast
  Hostname: Local, Peer IP: 0.0.0.0
  Source IP: 0.0.0.0, Total routes: 10
  Prefix          Next Hop          MED          Lpref          AS Path
198.51.100.75/24      198.51.100.93          -          100          -
198.51.100.76/24      198.51.100.94          -          100          -
198.51.100.77/24      198.51.100.95          -          100          -
198.51.100.95/24      198.51.100.95          -          100          -
198.51.100.99/24      198.51.100.95          -          100          -
Instance: default, AFI: ipv4, SAFI: vpn-unicast
  Hostname: Local, Peer IP: 0.0.0.0
  Source IP: 0.0.0.0, Total routes: 4
  Prefix          Next Hop          MED          Lpref          AS Path
198.51.100.14/24      2001:db8:0:13::          0          -          4200000004
    
```

198.51.100.17/24

2001:db8:0:13::

0

-

4200000004

## Example 4: Summary view of the received routes

```

supervisor@rtbrick: op> show bgp rib-in ipv4 unicast instance default peer address 198.51.100.94
Flags: & - Imported, ! - Error
Instance: ip2vrf, AFI: ipv4, SAFI: unicast
Hostname: Local, Peer IP: 0.0.0.0
Source IP: 0.0.0.0, Total routes: 13
  Prefix                Next Hop                MED      Lpref      AS Path
  198.51.100.75/24      198.51.100.93          -        100        -
  198.51.100.76/24      198.51.100.94          -        100        -
  198.51.100.77/24      198.51.100.95          -        100
    
```

## BGP RIB-out

This command displays the send routes.

Syntax:

**show bgp rib-out** <option> ...

Option	Description
-	Without any option, the command displays advertised BGP routes for all instances.
<afi>	BGP routing table summary for the given address family (AFI), all sub-address families and all instances. Supported AFI values are 'ipv4' and 'ipv6'.
<afi> <safi>	BGP routing table summary for the given address family (AFI) and sub-address family (SAFI), and all instances. Supported SAFI values are <b>evpn</b> , <b>evpn-vpws</b> , <b>flowspec</b> , <b>labeled-unicast</b> , <b>multicast</b> , <b>unicast</b> , <b>vpls</b> , <b>vpls-vpws</b> , <b>vpn-multicast</b> , and <b>vpn-unicast</b> .
<afi> <safi> detail	Detailed list view of the BGP routing table for the given address family (AFI) and sub-address family (SAFI), and all instances.
<afi> <safi> <prefix>	BGP routing table entry for the given prefix and all instances.
<afi> <safi> instance <instance-name>	BGP routing table summary for the given AFI, SAFI, and instance.



Option	Description
<afi> <safi> instance <instance-name> detail	Detailed list view of BGP routing table for the given AFI, SAFI, and instance.
<afi> <safi> instance <instance-name> <prefix>	BGP routing table entry for the given prefix and instance.
<afi> <safi> peer <name> / peer address <ip>	Peer name or address

Example 1: Summary view of the routes advertised to a peer

```

supervisor@rtbrick: op> show bgp rib-out ipv4 unicast peer CE1-Vrfl
Instance: vrfl, AFI: ipv4, SAFI: unicast
Peer: CE1-Vrfl, Sent routes: 4
  Prefix                MED          Lpref          Origin          Next Hop
AS Path
  198.51.100.104/24      0            -              Incomplete     -
65001
  198.51.100.113/24      0            -              Incomplete     -
65001
  198.51.100.117/24      0            -              Incomplete     -
65001
  198.51.100.106/24      0            -              Incomplete     -
65001
    
```

Example 2: Detailed view of the routes advertised to a peer

```

supervisor@rtbrick: op> show bgp rib-out
Instance: vrfl, AFI: ipv4, SAFI: unicast
Peer-group: pe1_cel, Sent routes: 4
  Prefix                MED          Lpref          Origin
Next Hop                AS Path
  198.51.100.104/24      0            -              65001
Incomplete -
  198.51.100.113/24      0            -              65001
Incomplete -
  198.51.100.105/24      0            -              65001
Incomplete -
  198.51.100.106/24      0            -              65001
Incomplete -
Instance: vrfl, AFI: ipv6, SAFI: unicast
Peer-group: pe1_cel, Sent routes: 3
  Prefix                MED          Lpref          Origin
Next Hop                AS Path
  2001:db8:0:14::/24     0            -              65001
Incomplete -
  2001:db8:0:15::/24     0            -              65001
Incomplete -
  2001:db8:0:16::/24     0            -              65001
Incomplete -
    
```

Example 3: Routes advertised to a peer

```

supervisor@rtbrick.net: cfg> show bgp fib ipv4 multicast
Instance: vrf1-blue, AFI: ipv4, SAFI: multicast
  Group          Source          Preference
Out Label      Route Type      Next Hop
-              -
20002,bos:1    Intra-AS_I-PMSI_AD  12.0.0.1
20002,bos:1    Intra-AS_I-PMSI_AD  12::1
 232.1.1.1/32  10.1.1.1/32      20
20002,bos:1    Source_Tree_Join    12.0.0.1
20002,bos:1    Source_Tree_Join    12::1
 232.1.2.1/32  10.1.1.1/32      20
20002,bos:1    Source_Tree_Join    12.0.0.1
20002,bos:1    Source_Tree_Join    12::1
    
```

## TCP Connections

This command displays information of the TCP connections used by BGP.

Syntax:

**show bgp tcp bgp.iod.1 connection** <option> ...

Option	Description
-	Without any option, the command displays the TCP connections used by BGP for all instances.
detail	Detailed list view of the the TCP connections for the given address family (AFI) and sub-address family (SAFI), and all instances.
prefix	TCP connections for the given prefix and all instances.
instance <instance-name>	TCP connections summary for the given instance.

Example 1: Summary view of the BGP TCP connections

```

supervisor@leaf1: cfg> show bgp tcp bgp.iod.1 connection
Instance      Local IP Address      Remote IP Address      Local
Port Remote Port State
default       2001:db8:0:189::     2001:db8:0:38::       179
49568         Established
default       2001:db8:0:61::      2001:db8:0:237::      50529
179           Established
    
```

Example 2: Detailed information of the BGP TCP connections

```

supervisor@leaf1: cfg> show bgp tcp bgp.iod.1 connection detail
Instance: default
Local IPv6 address      : 2001:db8:0:189::
Remote IPv6 address     : 2001:db8:0:38::
Local port              : 179
Remote port            : 49568
State                   : Established
  Internal
    Options              : -- | Keepalive | --
    TOS                  : 0
    TTL                  : 1
    Priority              : 1
    Flags                : -|-|-|-|Nagle Disabled|-|Wnd Scale|-|-|-
    Last trigger         : 27
    Timer                : 37624
  Timers
    Poll                 : 0s
    Poll interval       : 0s
    Retransmission      : 65535s
  Receiver
    Expected sequence   : 32965979
    Available window    : 96816
    Announced window   : 95562
    Announced wnd RT edge : 33061541
    MSS                  : 1440
    RTT estimate        : 0
  Timeout
    Sequence            : 17683639s
    Retransmission      : 3s
    Retransmissions     : 0s
    Duplicate acks      : 0s
    Highest ack'd sequence : 17683658s
  Congestion
    Window              : 162834
    Persist count       : 0
    Send scale          : 5
    Receive scale       : 5
  Sender
    Next seq to send    : 17683658
    Last wnd update seq : 32965979
    Last wnd update ack : 17683658
    Window              : 96192
    Max window announced : 96800
    Acknowledged        : None
    Send buf            : 56476
    Send queue length   : 0
    Unsent oversize     : 0
    TS last ack sent    : 818020352
  Keepalive
    Next keepalive idle : 7200000
    Keepalive interval  : 75000
    Keepalive count     : 9
    Keep sent count     : 0
  Authentication
    Auth type           : HMAC-SHA-256-128
    key1-id             : 255
    key2-id             : 0
    Algorithm mismatch  : 0
    Secret mismatch     : 43
    Latest sent digest  : 850fea02c98912ce4497ec2b101a4f7c

```

Latest received digest : a718fb88e0d7fd4a00843e6aec03c864

## TCP Statistics

This command displays TCP statistics information of the TCP connections used by BGP.

Syntax:

**show bgp tcp bgp.iod.1 statistics** <option> ...

Option	Description
-	Without any option, the command displays the TCP statistics information of the TCP connections used by BGP for all instances.
instance <instance-name>	TCP connections summary for the given instance.

Example: TCP statistics information of the TCP connections used by BGP for the default instance

```

supervisor@rtbrick: op> show bgp tcp bgp.iod.1 statistics instance default
Instance: default
  IP statistics
    Transmitted packets : 3103242412
    Received packets    : 47351
    Forwarded packets   : 0
    Dropped packets     : 0
    Checksum error      : 0
    Invalid length error : 0
    Out of memory error  : 0
    Routing error       : 0
    Protocol error      : 0
    Error in options    : 0
    Misc error          : 0
    Cachehit           : 0
  TCP statistics
    Transmitted packets : 365499779
    Received packets    : 5577
    Forwarded packets   : 3014656
    Dropped packets     : 46
    Checksum error      : 0
    Invalid length error : 0
    Out of memory error  : 0
    Routing error       : 3014656
    Protocol error      : 46
    Error in options    : 0
    Misc error          : 2097152
    Cachehit           : 1557594144
    
```

## BGP Clear Commands

Clear commands allow to reset operational states.

### BGP Peer

This commands resets BGP peerings.

Syntax:

**clear bgp peer** <option> ...

Option	Description
all	Clears all the BGP peers.
all soft-in <afi> <safi>	Sends route refresh to all neighbors.
all soft-out <afi> <safi>	Re-advertises all the routes previously sent to the peer.
all stats	Clears the statistics of all the BGP peers.
instance <instance> <peer-ip>	Clears the peer for the given instance and peer IP address.
instance <instance> <peer-ip> source <src-ip>	Clears a specific peer for the given peer IP address and source IP address in the specified instance.
instance <instance> all	Clears all peers in the given instance.
instance <instance> <peer-ip> source <src-ip> soft-in <afi> <safi>	Sends route refresh to specific peer for the given instance, peer-ip, source-ip and address-family.
instance <instance> <peer-ip> soft-in <afi> <safi>	Sends route refresh to peer for the given instance, peer-ip and address-family.
instance <instance> all soft-in <afi> <safi>	Sends route refresh to all peers for the given instance and address family.
instance <instance> <peer-ip> source <src-ip> soft-out <afi> <safi>	Re-advertises all the routes previously sent to the specific peer for the given instance, peer-ip, source-ip and address-family.

Option	Description
instance <instance> <peer-ip> soft-out <afi> <safi>	Sends route refresh to peer for a given instance, peer-ip and address-family.
instance <instance> all soft-out <afi> <safi>	Sends route update to all peers for given instance and address family.
instance <instance> <peer-ip> source <src-ip> stats	Clears the statistics of a specific peer for a given instance, peer-ip and source-IP.
instance <instance> <peer-ip> stats	Clears the statistics of the peer for a given instance and peer-IP.
instance <instance> all stats	Clears the statistics of all peers for a given instance.

Example: The example below shows how to clear all the BGP peers.

```
supervisor@rtbrick: op> clear bgp peer all
```

## 2.4. BGP FlowSpec

### 2.4.1. BGP FlowSpec Overview

BGP FlowSpec is an extension of the BGP protocol that allows for the dynamic propagation of more specific information than the traffic aggregate defined by an IP Prefix. This enables network administrators to control data traffic flow at any point in their network infrastructure. BGP FlowSpec can be used for various purposes, such as managing congestion or mitigating distributed denial-of-service (DDoS) attacks. Expanding routing information with FlowSpec allows the routing system to use the ACL (Access Control List) or firewall capabilities in the router’s forwarding path.

The figure below shows a traffic scrubbing station capable of generating the FlowSpec rule in the event of a DDoS attack and sending the BGP FlowSpec update to the neighbouring devices. The device that can interpret this update can drop the DDoS traffic as it arrives.

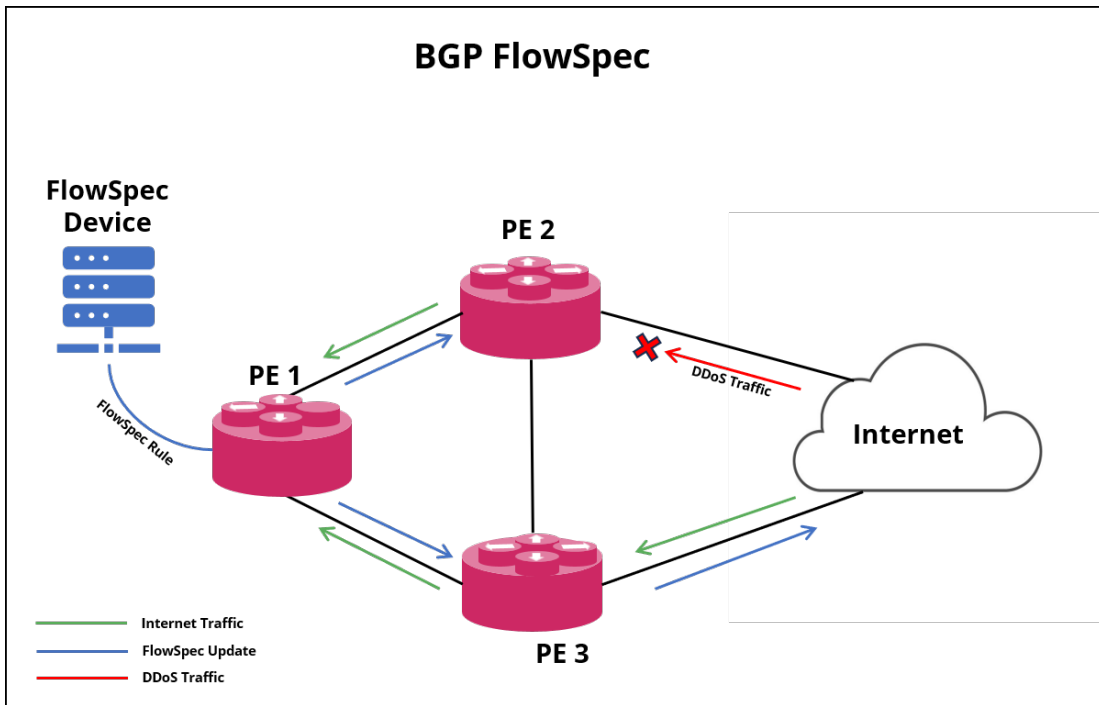

FlowSpec helps to establish matching criteria for IP traffic packets encoded into BGP Network Layer Reachability Information (NLRI). The requirements can include various attributes and may or may not involve reachability information. Routers can use FlowSpec to forward, shape, classify, rate limit, filter, or redirect packets based on specific policies, allowing for rules that operate on multiple fields of the packet header.

The figure below shows the high-level flow of BGP FlowSpec design.

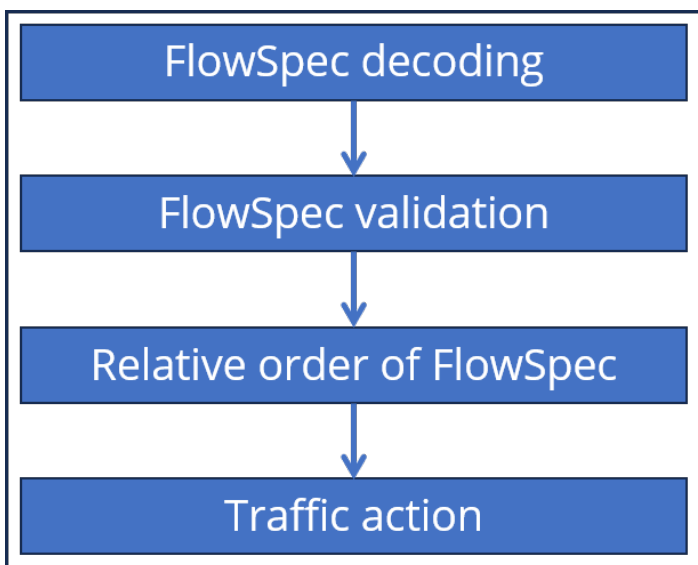

FlowSpec involves actively processing and inserting dynamic ACLs in an operational environment. When a router receives a FlowSpec update, it can dynamically create IP filters to mitigate intra-AS and inter-AS DDoS attacks and

other unwanted traffic patterns. Mitigation is implemented by dropping or rate-limiting the traffic at the network’s ingress point (or the nearest possible point toward the source of the DDoS attack).

## Supported BGP Standards

RFC Number	Description
RFC 8955	Dissemination of Flow Specification Rules for IPv4
RFC 8956	Dissemination of Flow Specification Rules for IPv6



RFC and draft compliance are partial except as specified.

## Supported Platforms

Not all features are necessarily supported on each hardware platform. Refer to the *Platform Guide* for the features and the sub-features that are or are not supported by each platform.

## Supported Matching Criteria and Actions

The tables below outline the FlowSpec supported matching criteria and actions.

BGP FlowSpec NLRI Type	Match Criteria & Description		Option	Supported (Yes/No)
Type 1	Destination-Prefix (ipv4/ipv6)	Defines the destination prefix to match	specific host	Yes
			IP range	Yes
Type 2	Source-Prefix (ipv4/ipv6)	Defines the source prefix to match.	specific host	Yes
			IP range	Yes
Type 3	IP-Protocol	Contains a set of {operator, value} pairs that match the IP protocol value byte in IP packets.	specific value	Yes
			multi-value range	No



<b>BGP FlowSpec NLRI Type</b>	<b>Match Criteria &amp; Description</b>		<b>Option</b>	<b>Supported (Yes/No)</b>
Type 4	Port (src or dst)	Defines a list of {operator, value} pairs that match source or destination ports.	specific value	No
			multi-value range	No
Type 5	Destination port	Defines a list of {operator, value} pairs used to match the destination port of a TCP or UDP packet.	specific value	Yes
			multi-value range	No
Type 6	Source port	Defines a list of {operator, value} pairs used to match the source port of a TCP or UDP packet.	specific value	Yes
			multi-value range	No
Type 7	ICMP type	Defines a list of {operator, value} pairs used to match the type field of an ICMP packet	specific value	No
			multi-value range	No
Type 8	ICMP code	Defines a list of {operator, value} pairs used to match the code field of an ICMP packet.	specific value	No
			multi-value range	No

<b>BGP FlowSpec NLRI Type</b>	<b>Match Criteria &amp; Description</b>		<b>Option</b>	<b>Supported (Yes/No)</b>
Type 9	TCP flag	IPv4 or IPv6 TCP flags(2 bytes include reserved bits)	specific value	No
			multi-value range	No
Type 10	Packet length	Match on the total IP packet length	specific value	No
			multi-value range	No
Type 11	DSCP	Defines a list of {operator, value} pairs that use a Multi-value range to match the 6-bit DSCP field.	specific value	No
			multi-value range	No
Type 12	Fragment	Identifies a fragment-type as the match Bit mask criterion for a class map.	specific value	No
			multi-value range	No



The maximum number of matches supported in a single FlowSpec rule is 8.

	<b>Action Criteria &amp; Description</b>		<b>Option</b>	<b>Supported (Yes/No)</b>
1	traffic-rate-bytes	Traffic-rate limits specified in bytes per second	0 (drop)	Yes
			>0	Yes

	Action Criteria & Description		Option	Supported (Yes/No)
2	traffic-rate-packets	Traffic-rate limits specified in packets per second	0 (drop)	Yes
			>0	No
3	traffic-action	Action that is performed on the traffic that matches FlowSpec rule	Terminal	No
			Sampling	No
4	rt-redirect	Redirects the traffic to a specific VRF instance or to a next-hop	to vrf	No
			to nexthop	No

### Operators Supported in Matching Criteria and Actions

Operator Type	Supported Operators	Unsupported Operators
Relational	equal	greater than, greater than or equal, less than, less than or equal, not equal
Logical	or	and

## 2.4.2. BGP FlowSpec Configuration

### Enabling BGP FlowSpec Address Family

Adding the FlowSpec address family to the BGP address-family configuration enables the exchange of BGP FlowSpec NLRIs.

Syntax:

```
set <instance> <instance-name> protocol bgp address-family <afi> <safi>
```

Attribute	Description
<instance-name>	Name of the BGP instance
<afi>	Address family identifier (AFI). Supported values: ipv4, ipv6
<safi>	Subsequent address family identifier (SAFI). Specify "flowspec" as the SAFI for BGP to enable the exchange of BGP FlowSpec NLRIs.

### Example 1: BGP FlowSpec IPv4 Configuration

```

supervisor@rtbrick>LEAF01: cfg> show config instance default protocol bgp address-
family ipv4 flowspec
{
  "rtbrick-config:address-family": [
    {
      "afi": "ipv4",
      "safi": "flowspec"
    }
  ]
}

```

### Example 2: BGP FlowSpec IPv6 Configuration

```

supervisor@rtbrick>LEAF01: cfg> show config instance default protocol bgp address-
family ipv6 flowspec
{
  "rtbrick-config:address-family": [
    {
      "afi": "ipv6",
      "safi": "flowspec"
    }
  ]
}

```

## Enabling BGP FlowSpec in Peer Group Address Family

Syntax:

**set instance** <instance-name> **protocol bgp peer-group** <peer-group-name>  
**address-family** <afi> <safi> <attribute> <value>

Attribute	Description
<afi>	Address family identifier (AFI). Supported values: ipv4, ipv6, l2vpn

Attribute	Description
<safi>	Subsequent address family identifier (SAFI). Specify "flowspec" as the SAFI to enable BGP FlowSpec in Peer Group address family.

### Example 1: BGP FlowSpec in Peer Group Address Family

```

supervisor@rtbrick>LEAF01: cfg> show config instance default protocol bgp peer-
group
{
  "rtbrick-config:peer-group": [
    {
      "pg-name": "PE2",
      "remote-as": 4200000002,
      "address-family": [
        {
          "afi": "ipv4",
          "safi": "flowspec"
        },
        {
          "afi": "ipv4",
          "safi": "unicast"
        },
        {
          "afi": "ipv6",
          "safi": "flowspec"
        },
        {
          "afi": "ipv6",
          "safi": "unicast"
        }
      ]
    }
  ]
}

```

## 2.4.3. BGP FlowSpec Operational Commands

### BGP Show Commands

#### show bgp peer

The 'show bgp peer' commands display information on BGP peers.

#### Syntax:

**show bgp peer** <option> ...

Option	Description
-	Without any option, the commands display all BGP peers in all instances in a summary table format.
detail	Detailed information on all BGP peers in all instances in a list view.
<peer-name>	Detailed information on the peer with the given name.
history	Displays BGP peer history information such as the peer state down reasons.
history <peer-address>	Displays BGP peer history information such as the peer state down reasons for a specified peer.
address <peer-address>	Detailed information on the peer with the given IP address.
instance <instance-name>	Summary of all BGP peers in the given instance.
instance <instance-name> detail	Detailed information on all BGP peers in the given instance.
instance <instance-name> detail <peer-name>	Detailed information on the peer with the given name in the given instance.
instance <instance-name> detail address <peer-address>	Detailed information on the peer with the given IP address in the given instance.
statistics	Received and sent BGP prefixes per AFI/SAFI for all peers in all instances.
statistics peer <peer-name>	Received and sent BGP prefixes per AFI/SAFI for the peer with the given name.
statistics peer address <peer-address>	Received and sent BGP prefixes per AFI/SAFI for the peer with the given IP address.
statistics instance <instance-name> peer <peer-name>	Received and sent BGP prefixes per AFI/SAFI for the peer with the given name in the given instance.
statistics instance <instance-name> peer address <peer-address>	Received and sent BGP prefixes per AFI/SAFI for the peer with the given IP address in the given instance

### Example 1: BGP Peer Summary View

```

supervisor@rtbrick>LEAF01: op> show bgp peer
Instance: default
  Peer      Remote AS   State           Up/Down Time   PfxRcvd  PfxSent
  PE2      4200000002  Established     0d:01h:35m:53s 42        72
  99.1.1.2 65002      Established     0d:01h:35m:53s 2         27
    
```

### Example 2: BGP Peer Detail View

```

supervisor@rtbrick>LEAF01: op> show bgp peer detail
Peer: PE2, Peer IP: 12.0.0.2, Remote AS: 4200000002, Local: 12.0.0.1, Local AS:
4200000001, Any AS: False
  Type: ebgp, State: Established, Up/Down Time: 0d:01h:38m:59s, Reason: Cease,
Sub-Code: Admin reset
  Discovered on interface: -
  Last transition: Thu Jun 20 09:35:06 GMT +0000 2024, Flap count: 1
  Peer ID      : 192.168.0.20, Local ID   : 192.168.0.10
  Instance     : default, Peer group: PE2
  6PE enabled  : False
  Timer values:
    Peer keepalive : 30s, Local keepalive: 30s
    Peer holddown  : 90s, Local holddown : 90s
    Connect retry  : 30s
  Timers:
    Connect retry timer : 0s
    keepalive timer     : expires in 10s 882996us
    Holddown timer      : expires in 1m 12s 538155us
  NLRIs:
    Sent      : ['l2vpn-evpn', 'l2vpn-vpls', 'ipv4-unicast', 'ipv6-unicast',
'ipv4-flowspec', 'ipv6-flowspec', 'ipv4-vpn-unicast', 'ipv6-vpn-unicast', 'ipv4-
vpn-multicast', 'ipv4-labeled-unicast', 'ipv6-labeled-unicast']
    Received   : ['l2vpn-evpn', 'l2vpn-vpls', 'ipv4-unicast', 'ipv6-unicast',
'ipv4-flowspec', 'ipv6-flowspec', 'ipv4-vpn-unicast', 'ipv6-vpn-unicast', 'ipv4-
vpn-multicast', 'ipv4-labeled-unicast', 'ipv6-labeled-unicast']
    Negotiated : ['l2vpn-evpn', 'l2vpn-vpls', 'ipv4-unicast', 'ipv6-unicast',
'ipv4-flowspec', 'ipv6-flowspec', 'ipv4-vpn-unicast', 'ipv6-vpn-unicast', 'ipv4-
vpn-multicast', 'ipv4-labeled-unicast', 'ipv6-labeled-unicast']
  Capabilities:
    Addpath sent           : None
    Addpath received      : None
    Addpath negotiated     : None
    Extended nexthop sent : None
    Extended nexthop received : None
    Extended nexthop negotiated : None
  Capabilities:
    Feature      Sent      Received  Negotiated
    Route refresh True      True      True
    4 byte AS    True      True      True
    Graceful restart False     False     False
    Link local only False     False     False
  Prefix Limit:
  End of RIB:
    Address family      Sent      Received
    IPv4 unicast        Thu Jun 20 09:35:11 GMT +0000 2024  Thu Jun 20
09:35:11 GMT +0000 2024
    IPv4 labeled-unicast Thu Jun 20 09:35:11 GMT +0000 2024  Thu Jun 20
09:35:11 GMT +0000 2024
    IPv6 unicast        Thu Jun 20 09:35:11 GMT +0000 2024  Thu Jun 20
09:35:11 GMT +0000 2024
    
```

```

IPv6 labeled-unicast Thu Jun 20 09:35:11 GMT +0000 2024 Thu Jun 20
09:35:11 GMT +0000 2024
IPv4 VPN-unicast Thu Jun 20 09:35:11 GMT +0000 2024 Thu Jun 20
09:35:11 GMT +0000 2024
IPv6 VPN-unicast Thu Jun 20 09:35:11 GMT +0000 2024 Thu Jun 20
09:35:11 GMT +0000 2024
IPv4 flowspec Thu Jun 20 09:35:11 GMT +0000 2024 Thu Jun 20
09:35:11 GMT +0000 2024
IPv6 flowspec Thu Jun 20 09:35:11 GMT +0000 2024 Thu Jun 20
09:35:11 GMT +0000 2024
IPv4 VPN-multicast Thu Jun 20 09:35:11 GMT +0000 2024 Thu Jun 20
09:35:11 GMT +0000 2024
L2VPN VPLS Thu Jun 20 09:35:11 GMT +0000 2024 Thu Jun 20
09:35:11 GMT +0000 2024
L2VPN EVPN Thu Jun 20 09:35:11 GMT +0000 2024 Thu Jun 20
09:35:11 GMT +0000 2024
Message stats:
Session stats:
  Direction  Open      Update      Keepalive    Notify      Route
refresh
  Input      1         40          235         0           0
  Output     1         52          239         0           0
Total stats:
  Input      2         80          299         0           0
  Output     2         102         302         1           0
Route stats:
  Address family      Received      Sent      Prefix limit Idle
timeout
  IPv4 unicast        4             4         0           0
  IPv4 labeled-unicast 2             2         0           0
  IPv6 unicast        4             4         0           0
  IPv6 labeled-unicast 2             2         0           0
  IPv4 VPN-unicast    8             4         0           0
  IPv6 VPN-unicast    6             4         0           0
  IPv4 VPN-multicast  2             6         0           0
  L2VPN VPLS         7             7         0           0
  L2VPN EVPN         7             7         0           0
  IPv4 flowspec       0             8         0           0
  IPv6 flowspec       0             0         0           0
Peer: , Peer IP: 99.1.1.2, Remote AS: 65002, Local: 99.1.1.1, Local AS:
4200000001, Any AS: False
Type: ebgp, State: Established, Up/Down Time: 0d:01h:38m:59s, Reason: Cease,
Sub-Code: Admin reset
Discovered on interface: -
Last transition: Thu Jun 20 09:35:06 GMT +0000 2024, Flap count: 2
Peer ID      : 192.168.1.3, Local ID  : 192.168.0.10
Instance     : default, Peer group: SN
6PE enabled  : False
Timer values:
Peer keepalive : 30s, Local keepalive: 30s
Peer holddown  : 90s, Local holddown : 90s
Connect retry  : 30s
Timers:
Connect retry timer : 0s
keepalive timer     : expires in 14s 885374us
Holddown timer      : expires in 1m 806199us
NLRIs:
Sent              : ['ipv4-unicast', 'ipv6-unicast', 'ipv4-flowspec', 'ipv6-
flowspec']
Received          : ['ipv4-flowspec', 'ipv6-flowspec']
Negotiated        : ['ipv4-flowspec', 'ipv6-flowspec']

```



```

Capabilities:
  Addpath sent           : None
  Addpath received      : None
  Addpath negotiated     : None
  Extended nexthop sent  : None
  Extended nexthop received : ['ipv4-flowspec', 'ipv6-flowspec']
  Extended nexthop negotiated : None
Capabilities:
  Feature           Sent      Received      Negotiated
  Route refresh     True       True         True
  4 byte AS         True       True         True
  Graceful restart  False      False        False
  Link local only   False      False        False
<...>
    
```

#### Example 4: BGP Peer history for a specified peer

```

supervisor@rtbrick.net: op> show bgp peer history peer address 192:168::40
Instance: ip2vrf
  Peer Address           Source Address           Type           Last
  Reset Reason
  192:168::40           192:168:5::20          FSM Error      FSM
Error, Sub-Code: Unexpected message in OpenSent State
    
```

### show bgp rib-in

This command displays the received routes.

#### Syntax:

**show bgp rib-in** <option> ...

Option	Description
-	Without any option, the command displays information on the received BGP routing table on all instances in a summary table format.
<afi>	BGP routing table summary for the given address family (AFI), all sub-address families and all instances. Supported AFI values are 'ipv4' and 'ipv6'.
<afi> <safi>	BGP routing table summary for the given address family (AFI) and sub-address family (SAFI), and all instances. Supported SAFI values are 'labeled-unicast', 'unicast', 'vpn-multicast', 'vpn-unicast', 'evpn-vpws', 'evpn', 'vpls-vpws', 'vpls', and 'flowspec'.

Option	Description
<afi> <safi> detail	Detailed list view of the BGP routing table for the given address family (AFI) and sub-address family (SAFI), and all instances.
<afi> <safi> <prefix>	BGP routing table entry for the given prefix and all instances.
<afi> <safi> instance <instance-name>	BGP routing table summary for the given AFI, SAFI, and instance.
<afi> <safi> instance <instance-name> detail	Detailed list view of BGP routing table for the given AFI, SAFI, and instance.
<afi> <safi> instance <instance-name> <prefix>	BGP routing table entry for the given prefix and instance.
<afi> <safi> community <community-name>	BGP community details for the given AFI, SAFI, and instance.
<afi> <safi> error	BGP route with error status for the given AFI, SAFI, and instance.
<afi> <safi> peer <name> / peer address <ip>	Peer name or address

Example 1: Summary view of the BGP rib-in for the ipv4 flowspec address family.

```

supervisor@rtbrick>LEAF01: op> show bgp rib-in ipv4 flowspec
Flags: & - Imported, ! - Error
Instance: default, AFI: ipv4, SAFI: flowspec
Peer IP: 99.1.1.2, Source IP: 99.1.1.1, Total routes: 2
  Flowspec Hash      Match                                     Action
AS Path      Status
  236e3111          src-prefix : 192.0.2.3/32                rate-
limit:400.0 kbps  65002          Valid
                                     ip-PROTO  : [ ==tcp or ==udp ]
                                     src-port   : [ ==200 or ==100 or ==300 ]
  e05a9523          dest-prefix : 203.0.113.0/24            discard
65002              Valid
    
```

Example 2: Summary view of the BGP rib-in for the ipv6 flowspec address family.

```

supervisor@rtbrick>LEAF01: op> show bgp rib-in ipv6 flowspec
Flags: & - Imported, ! - Error
Instance: default, AFI: ipv6, SAFI: flowspec
Peer IP: 99.1.1.2, Source IP: 99.1.1.1, Total routes: 1
  Flowspec Hash      Match
Action              AS Path      Status
    
```

```

eff682bf          src-prefix  : 2001:db8::1/128
rate-limit:500.0 kbps -      Valid
                    ip-proto   : [ ==udp ]
                    src-port   : [ ==4000 or ==5000 ]
    
```

**Example 3: Summary view of the BGP rib-in for the IPv4 with the error flag.**

```

supervisor@rtbrick>rtbrick.net: op> show bgp rib-in ipv4
Flags: & - Imported, ! - Error
Instance: default, AFI: ipv4, SAFI: unicast
  Hostname: Local, Peer IP: 0.0.0.0
  Source IP: 0.0.0.0, Total routes: 4
    Flags Prefix           Next Hop MED      Lpref   AS Path
    -----
    - 12.0.0.0/24          -         0        100     -
    - 12.1.0.0/24          -         0        100     -
    - 192.168.0.10/32     -         0        100     -
    - 192.168.0.11/32     -         0        100     -
  Hostname: Pl, Peer IP: 12.0.0.2
  Source IP: 12.0.0.1, Total routes: 4
    Flags Prefix           Next Hop MED      Lpref   AS Path
    -----
    - 12.0.0.0/24          12.0.0.2 0         -        4200000002
    - 12.1.0.0/24          12.0.0.2 0         -        4200000002
    - 192.168.0.20/32     12.0.0.2 0         -        4200000002
    - 192.168.0.21/32     12.0.0.2 0         -        4200000002
    
```

**show bgp rib-out**

This command displays the send routes.

**Syntax:**

**show bgp rib-out** <option> ...

Option	Description
-	Without any option, the command displays advertised BGP routes for all instances.
<afi>	BGP routing table summary for the given address family (AFI), all sub-address families and all instances. Supported AFI values are 'ipv4' and 'ipv6'.
<afi> <safi>	BGP routing table summary for the given address family (AFI) and sub-address family (SAFI), and all instances. Supported SAFI values are 'unicast', 'labeled-unicast', 'multicast', 'vpn-unicast', 'evpn', 'vpls', 'vpls-vpws', and 'flowspec'.

Option	Description
<afi> <safi> detail	Detailed list view of the BGP routing table for the given address family (AFI) and sub-address family (SAFI), and all instances.
<afi> <safi> <prefix>	BGP routing table entry for the given prefix and all instances.
<afi> <safi> instance <instance-name>	BGP routing table summary for the given AFI, SAFI, and instance.
<afi> <safi> instance <instance-name> detail	Detailed list view of BGP routing table for the given AFI, SAFI, and instance.
<afi> <safi> instance <instance-name> <prefix>	BGP routing table entry for the given prefix and instance.
<afi> <safi> peer <name> / peer address <ip>	Peer name or address

Example 1: Summary view of the IPv4 FlowSpec routes advertised to a peer

```

supervisor@rtbrick>LEAF01: op> show bgp rib-out ipv4 flowspec
Instance: default, AFI: ipv4, SAFI: flowspec
Peer-group: PE2, Sent routes: 2
Flowspec Hash      Match
Action             Origin
236e3111           src-prefix  : 192.0.2.3/32
rate-limit:400.0 kbps  Incomplete
                    ip-proto   : [ ==tcp or ==udp ]
                    src-port    : [ ==200 or ==100 or ==300 ]
e05a9523           dest-prefix : 203.0.113.0/24
discard            Incomplete
    
```

Example 2: Summary view of the IPv6 FlowSpec routes advertised to a peer

```

supervisor@rtbrick>LEAF01: op> show bgp rib-out ipv6 flowspec
Instance: default, AFI: ipv6, SAFI: flowspec
Peer-group: PE2, Sent routes: 1
Flowspec Hash      Match
Action             Origin
eff682bf           src-prefix  : 2001:db8::1/128
rate-limit:500.0 kbps  Incomplete
                    ip-proto   : [ ==udp ]
                    src-port    : [ ==4000 or ==5000 ]
    
```

## show bgp fib

The 'show bgp fib' commands display the BGP forwarding table. In contrast to the 'show bgp rib' commands, the output of the 'show bgp fib' commands includes only the selected routes. The BGP route selection occurs between the RIB and the FIB.

### Syntax:

**show bgp fib** <option> ...

Option	Description
-	Without any option, the commands display the BGP forwarding table for all address families and all instances in a summary table format.
<afi>	BGP forwarding table summary for the given address family (AFI), all sub-address families and all instances. Supported AFI values are 'ipv4' and 'ipv6'.
<afi> <safi>	BGP forwarding table summary for the given address family (AFI) and sub-address family (SAFI), and all instances. Supported SAFI values are 'unicast', 'labeled-unicast', 'vpn-multicast', 'vpn-unicast', 'evpn-vpws', 'vpls', 'vpls-vpws' and 'flowspec'.
<afi> <safi> detail	Detailed list view of the BGP forwarding table for the given address family (AFI) and sub-address family (SAFI), and all instances.
<afi> <safi> <prefix>	BGP forwarding table entry for the given prefix and all instances.
<afi> <safi> instance <instance-name>	BGP forwarding table summary for the given AFI, SAFI, and instance.
<afi> <safi> instance <instance-name> detail	Detailed list view of BGP forwarding table for the given AFI, SAFI, and instance.
<afi> <safi> instance <instance-name> <prefix>	BGP forwarding table entry for the given prefix and instance.

Example 1: Summary view of the BGP FIB for IPv4 flowspec address family

```

supervisor@rtbrick>LEAF01: op> show bgp fib ipv4 flowspec
Instance: default, AFI: ipv4, SAFI: flowspec
  Flowspec Hash          Match          Action
Priority  Status
  236e3111              src-prefix   : 192.0.2.3/32      rate-
limit:400.0 kbps      1502        Installed
                                     ip-proto    : [ ==tcp or ==udp ]
                                     src-port    : [ ==200 or ==100 or ==300 ]
  e05a9523              dest-prefix  : 203.0.113.0/24      discard
1501          Installed
    
```

### Example 2: Summary view of the BGP FIB for a specific IPv4 flowspec hash

```

supervisor@rtbrick>LEAF01: op> show bgp fib ipv4 flowspec e05a9523
Instance: default, AFI: ipv4, SAFI: flowspec
Flowspec hash: e05a9523
Match:
  dest-prefix: 203.0.113.0/24
Action:
  discard
Extended community:
  flowspec:traffic-rate-bytes:0:0.000000
Priority: 1509
Status: Installed
Number of ACL installed: 1
Rule: bgp-flowspec-e05a95230d1f7153ac561b564947a9457b1083f57fa5cb10
ACL type: l3v4
Ordinal: 0          Priority: 1501
Match:
  Destination IPv4 prefix: 203.0.113.0/24
Action:
  Drop: True
Statistics:
          Total          Accepted          Dropped
Packets: 45              0                45
Bytes:   11700           0                11700
    
```

### Example 3: Summary view of the BGP FIB for IPv6 flowspec address family

```

supervisor@rtbrick>LEAF01: op> show bgp fib ipv6 flowspec
Instance: default, AFI: ipv6, SAFI: flowspec
  Flowspec Hash          Match          Action
Priority  Status
  eff682bf              src-prefix   : 2001:db8::1/128    rate-
limit:500.0 kbps      1501        Installed
                                     ip-proto    : [ ==udp ]
                                     src-port    : [ ==4000 or ==5000 ]
    
```

### Example 3: Summary view of the BGP FIB for a specific IPv4 flowspec address family

```

supervisor@rtbrick>LEAF01: op> show bgp fib ipv4 flowspec 236e3111
    
```

```

Instance: default, AFI: ipv4, SAFI: flowspec
Flowspec hash: 236e3111
Match:
  src-prefix: 192.0.2.3/32
  ip-proto: [ ==tcp or ==udp ]
  src-port: [ ==200 or ==100 or ==300 ]
Action:
  rate-limit:400.0 kbps
Extended community:
  flowspec:traffic-rate-bytes:0:400000.000000
Priority: 1502
Status: Installed
Number of ACL installed: 6
Rule: bgp-flowspec-236e31110de8e5920e5caed1e4bc3fe92d570bda99bd49f7
  ACL type: l3v4
  Ordinal: 4          Priority: 1502
  Match:
    Source IPv4 prefix: 192.0.2.3/32
    Source L4 port:: 100
    IP protocol: udp
  ACL type: l3v4
  Ordinal: 3          Priority: 1502
  Match:
    Source IPv4 prefix: 192.0.2.3/32
    Source L4 port:: 200
    IP protocol: udp
  ACL type: l3v4
  Ordinal: 0          Priority: 1502
  Match:
    Source IPv4 prefix: 192.0.2.3/32
    Source L4 port:: 200
    IP protocol: tcp
  ACL type: l3v4
  Ordinal: 2          Priority: 1502
  Match:
    Source IPv4 prefix: 192.0.2.3/32
    Source L4 port:: 300
    IP protocol: tcp
  ACL type: l3v4
  Ordinal: 5          Priority: 1502
<...>
    
```

## Show Command Filter Options for RIB-in, RIB-out, and FIB

### Syntax

**show bgp fib|rib-in|rib-out <afi> flowspec filter <options>**

Option	Description
<afi> flowspec filter <options>	Filter BGP Flowspec entries across the RIB based on the option specified.
destination-port	Filters based on destination port number.
destination-prefix	Filters based on the destination IP prefix.

Option	Description
instance-name	Filters entries based on the BGP instance. Useful to verify the Flowspec entries specific to one instance in a multi-instance BGP configurations.
ip-proto	Filters based on the protocol.
port	Filters Flowspec entries based on the protocol port number.
source-port	Filters entries based on the source port. Useful to identify different applications or services originating from specific ports.
source-prefix	Filters entries based on the source IP prefix.

```

supervisor@rtbrick.net: cfg> show bgp rib-in ipv4 flowspec filter port 3344
Flags: & - Imported, ! - Error
Instance: default, AFI: ipv4, SAFI: flowspec
  Hostname: SN, Peer IP: 23.1.1.3
  Source IP: 23.1.1.1, Total routes: 9999
    Flags  Flowspec Hash
Action          AS Path
None            647718a2
123.123.133.1/32
!ospf or >=udp or <=igmp ]
>=3345 or >3346 ]
>=3345 or >3346 ]
>=3345 or >3346 ]
None            f547079c
123.123.133.1/32
!ospf or >=udp or <=igmp ]
>=3344 or >3345 ]
>=3344 or >3345 ]
>=3344 or >3345 ]
None            fa25370c
123.123.133.1/32
!ospf or >=udp or <=igmp ]
>=3343 or >3344 ]
Match
dest-prefix : 10.1.1.1/32
src-prefix  :
ip-proto   : [ ==tcp or
port       : [ ==3344 and
dst-port   : [ ==3344 and
src-port    : [ ==3344 and
dest-prefix : 10.1.1.1/32
src-prefix  :
ip-proto   : [ ==tcp or
port       : [ ==3343 and
dst-port   : [ ==3343 and
src-port    : [ ==3343 and
dest-prefix : 10.1.1.1/32
src-prefix  :
ip-proto   : [ ==tcp or
port       : [ ==3342 and

```



```

dst-port      : [ ==3342 and
>=3343 or >3344 ]
src-port      : [ ==3342 and
>=3343 or >3344 ]

```

```

supervisor@rtbrick.net: cfg> show bgp rib-in ipv4 flowspec filter destination-
prefix 20.1.1.1/32
Flags: & - Imported, ! - Error
Instance: default, AFI: ipv4, SAFI: flowspec
  Hostname: SN, Peer IP: 23.1.1.3
  Source IP: 23.1.1.1, Total routes: 9999
  Flags  Flowspec Hash
Action          AS Path
  36f587c2
None           65002
123.123.133.1/32
! =ospf or >=udp or <=igmp ]
>=29 or >30 ]
>=29 or >30 ]
>=29 or >30 ]
dbedeed9
None           65002
123.123.133.1/32
! =ospf or >=udp or <=igmp ]
>=9979 or >9980 ]
>=9979 or >9980 ]
>=9979 or >9980 ]
Match
dest-prefix : 20.1.1.1/32
src-prefix  :
ip-proto   : [ ==tcp or
port       : [ ==28 and
dst-port   : [ ==28 and
src-port   : [ ==28 and
dest-prefix : 20.1.1.1/32
src-prefix  :
ip-proto   : [ ==tcp or
port       : [ ==9978 and
dst-port   : [ ==9978 and
src-port   : [ ==9978 and

```

```

supervisor@rtbrick.net: cfg> show bgp rib-in ipv4 flowspec filter source-prefix
20.123.133.1/32
Flags: & - Imported, ! - Error
Instance: default, AFI: ipv4, SAFI: flowspec
  Hostname: SN, Peer IP: 23.1.1.3
  Source IP: 23.1.1.1, Total routes: 9999
  Flags  Flowspec Hash
Action          AS Path
  38bfcfd3
None           65002
20.123.133.1/32
! =ospf or >=udp or <=igmp ]
>=252 or >253 ]
>=252 or >253 ]
>=252 or >253 ]
Match
dest-prefix : 10.1.1.1/32
src-prefix  :
ip-proto   : [ ==tcp or
port       : [ ==251 and
dst-port   : [ ==251 and
src-port   : [ ==251 and

```

```

5fa337e5
None                               65002
20.123.133.1/32
!=ospf or >=udp or <=igmp ]
>=9998 or >9999 ]
>=9998 or >9999 ]
>=9998 or >9999 ]
91c84623
None                               65002
20.123.133.1/32
!=ospf or >=udp or <=igmp ]
>=155 or >156 ]
>=155 or >156 ]
>=155 or >156 ]

dest-prefix : 10.1.1.1/32
src-prefix  :
ip-proto   : [ ==tcp or
port       : [ ==9997 and
dst-port   : [ ==9997 and
src-port   : [ ==9997 and
dest-prefix : 10.1.1.1/32
src-prefix  :
ip-proto   : [ ==tcp or
port       : [ ==154 and
dst-port   : [ ==154 and
src-port   : [ ==154 and

```

```

supervisor@rtbrick.net: cfg> show bgp rib-in ipv4 flowspec filter destination-port
100
Flags: & - Imported, ! - Error
Instance: default, AFI: ipv4, SAFI: flowspec
  Hostname: SN, Peer IP: 23.1.1.3
  Source IP: 23.1.1.1, Total routes: 9999
  Flags  Flowspec Hash
Action                               AS Path
None                               65002
123.123.133.1/32
!=ospf or >=udp or <=igmp ]
>=101 or >102 ]
>=101 or >102 ]
>=101 or >102 ]
2eaa5fab
None                               65002
123.123.133.1/32
!=ospf or >=udp or <=igmp ]
>=100 or >101 ]
>=100 or >101 ]
>=100 or >101 ]
3b8548f9
None                               65002

Match
dest-prefix : 10.1.1.1/32
src-prefix  :
ip-proto   : [ ==tcp or
port       : [ ==100 and
dst-port   : [ ==100 and
src-port   : [ ==100 and
dest-prefix : 10.1.1.1/32
src-prefix  :
ip-proto   : [ ==tcp or
port       : [ ==99 and
dst-port   : [ ==99 and
src-port   : [ ==99 and
dest-prefix : 10.1.1.1/32

```

```

123.123.133.1/32
!ospf or >=udp or <=igmp ]
>=99 or >100 ]
>=99 or >100 ]
>=99 or >100 ]

src-prefix :
ip-proto  : [ ==tcp or
port      : [ ==98 and
dst-port  : [ ==98 and
src-port  : [ ==98 and

```

```

supervisor@rtbrick.net: cfg> show bgp rib-in ipv4 flowspec filter source-port 200
Flags: & - Imported, ! - Error
Instance: default, AFI: ipv4, SAFI: flowspec
  Hostname: SN, Peer IP: 23.1.1.3
  Source IP: 23.1.1.1, Total routes: 9999
  Flags  Flowspec Hash
Action          AS Path
          908f5353
None           65002
123.123.133.1/32
!ospf or >=udp or <=igmp ]
>=200 or >201 ]
>=200 or >201 ]
>=200 or >201 ]
          a6c7b490
None           65002
123.123.133.1/32
!ospf or >=udp or <=igmp ]
>=201 or >202 ]
>=201 or >202 ]
>=201 or >202 ]
          c2a0d3e2
None           65002
123.123.133.1/32
!ospf or >=udp or <=igmp ]
>=199 or >200 ]
>=199 or >200 ]
>=199 or >200 ]

Match
dest-prefix : 10.1.1.1/32
src-prefix  :
ip-proto    : [ ==tcp or
port        : [ ==199 and
dst-port    : [ ==199 and
src-port    : [ ==199 and
dest-prefix : 10.1.1.1/32
src-prefix  :
ip-proto    : [ ==tcp or
port        : [ ==200 and
dst-port    : [ ==200 and
src-port    : [ ==200 and
dest-prefix : 10.1.1.1/32
src-prefix  :
ip-proto    : [ ==tcp or
port        : [ ==198 and
dst-port    : [ ==198 and
src-port    : [ ==198 and

```

```

supervisor@rtbrick.net: cfg> show bgp rib-in ipv4 flowspec filter ip-proto icmp
Flags: & - Imported, ! - Error
Instance: default, AFI: ipv4, SAFI: flowspec

```

```

Hostname: SN, Peer IP: 23.1.1.3
Source IP: 23.1.1.1, Total routes: 9999
  Flags  Flowspec Hash
Action          AS Path
None            65002
123.123.133.1/32
!=ospf or >=udp or <=igmp or <icmp ]
>=9517 or >9518 ]
>=9517 or >9518 ]
>=9517 or >9518 ]
db68d8a6
None            65002
123.123.133.1/32
!=ospf or >=udp or <=igmp or >icmp ]
>=30 or >31 ]
>=30 or >31 ]
>=30 or >31 ]
deb2048d
None            65002
123.123.133.1/32
!=ospf or >=udp or <=igmp or <icmp ]
>=9675 or >9676 ]
>=9675 or >9676 ]
>=9675 or >9676 ]
Match
dest-prefix : 10.1.1.1/32
src-prefix  :
ip-PROTO    : [ ==tcp or
port         : [ ==9516 and
dst-port    : [ ==9516 and
src-port    : [ ==9516 and
dest-prefix : 10.1.1.1/32
src-prefix  :
ip-PROTO    : [ ==tcp or
port         : [ ==29 and
dst-port    : [ ==29 and
src-port    : [ ==29 and
dest-prefix : 10.1.1.1/32
src-prefix  :
ip-PROTO    : [ ==tcp or
port         : [ ==9674 and
dst-port    : [ ==9674 and
src-port    : [ ==9674 and

```

## Validating FlowSpec ACLs

In forwarding, the FlowSpec rules can be validated using the "show acl rule <...>" command as shown in the example below:

```

supervisor@rtbrick>LEAF01: op> show acl rule bgp-flowspec-
b9342ffc0d1f7153ac561b564947a9457b1083f57fa5cb10
Rule: bgp-flowspec-b9342ffc0d1f7153ac561b564947a9457b1083f57fa5cb10
ACL type: l3v4
Ordinal: 0          Priority: 1501
Match:
  Direction: ingress
  Destination IPv4 prefix: 203.0.113.0/24
Action:
  Stats enabled: True
  Drop: True

```

```

Result:
  ACL Handle: 93
Statistics:
  Units      Total      Accepted  Dropped
  Packets    45          0         45
  Bytes      11700      0         11700
    
```

## BGP FlowSpec Clear Commands

Clear commands allow to reset operational states.

### BGP Peer

This commands resets BGP peerings.

Syntax:

**clear bgp peer** <option> ...

Option	Description
all	Clears all the BGP peers.
all soft-in <afi> <safi>	Sends route refresh to all neighbors.
all soft-out <afi> <safi>	Re-advertises all the routes previously sent to the peer.
all stats	Clears the statistics of all the BGP peers.
instance <instance> <peer-ip>	Clears the peer for the given instance and peer IP address.
instance <instance> <peer-ip> source <src-ip>	Clears a specific peer for the given peer IP address and source IP address in the specified instance.
instance <instance> all	Clears all peers in the given instance.
instance <instance> <peer-ip> source <src-ip> soft-in <afi> <safi>	Sends route refresh to specific peer for the given instance, peer-ip, source-ip and address-family.
instance <instance> <peer-ip> soft-in <afi> <safi>	Sends route refresh to peer for the given instance, peer-ip and address-family.
instance <instance> all soft-in <afi> <safi>	Sends route refresh to all peers for the given instance and address family.

Option	Description
instance <instance> <peer-ip> source <src-ip> soft-out <afi> <safi>	Re-advertises all the routes previously sent to the specific peer for the given instance, peer-ip, source-ip and address-family.
instance <instance> <peer-ip> soft-out <afi> <safi>	Sends route refresh to peer for a given instance, peer-ip and address-family.
instance <instance> all soft-out <afi> <safi>	Sends route update to all peers for given instance and address family.
instance <instance> <peer-ip> source <src-ip> stats	Clears the statistics of a specific peer for a given instance, peer-ip and source-IP.
instance <instance> <peer-ip> stats	Clears the statistics of the peer for a given instance and peer-IP.
instance <instance> all stats	Clears the statistics of all peers for a given instance.

Example: The example below shows how to clear all the BGP peers.

```
supervisor@rtbrick: op> clear bgp peer all
```

Example: Route Refresh in IPv4/IPv6 for BGP FlowSpec

```
supervisor@rtbrick: op> clear bgp peer all soft-out ipv4 flowspec
supervisor@rtbrick: op> clear bgp peer all soft-in ipv6 flowspec
```

## 2.5. BGP RPKI-RTR Route Validation

### 2.5.1. BGP RPKI-RTR Prefix Validation Overview

BGP is the core of the Internet, serving as the backbone protocol that enables exchange of traffic between networks. It plays a crucial role in connecting autonomous systems and ensuring reliable data transmission across the Internet. However, BGP has some inherent security limitations due to its design. It cannot verify whether incoming BGP advertisements come from an authorized autonomous system (AS). This limitation leaves BGP open to various attacks such

as route hijacking.

## Challenges Due to False Prefix Announcements

### Route Hijacking

An attacker can falsely advertise ownership of an IP prefix to redirect or intercept traffic. Also, an autonomous system can incorrectly advertise routes it learned from one provider to other providers. This can be an accidental route leak that directs routes to unintended destinations.

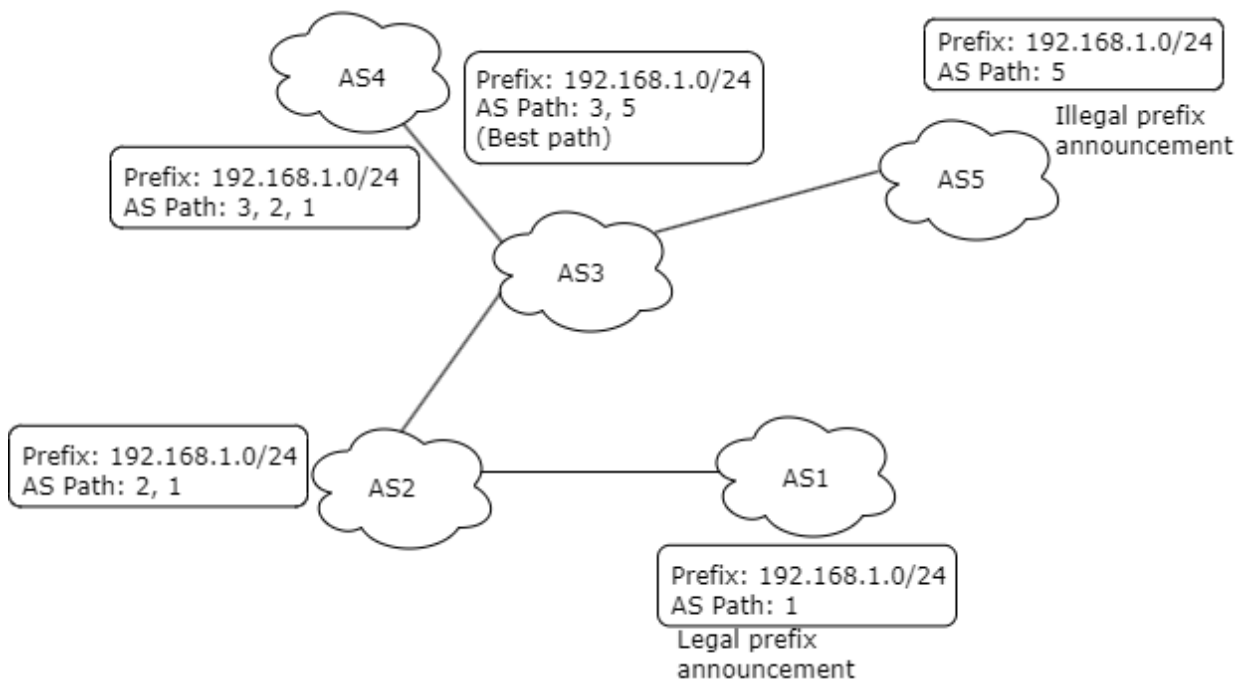

The preceding image is an example of a prefix hijacking scenario. 'AS1' announces 192.168.1.0/24, while an attacker announces the same prefix from 'AS5'. 'AS1' is the only authorized to originate and announce this prefix on the Internet. 'AS5', without authorization, sends a BGP announcement for the same prefix, 192.168.1.0/24. As a result, other ASes on the Internet receive two conflicting announcements for this prefix, one from 'AS1' and another from 'AS5'. AS4 prefers AS5's announcement due to the shortest AS path. So, AS5's unauthorized announcement is selected as the best path; traffic intended for 192.168.1.0/24 will be rerouted to 'AS5' instead of 'AS1'.

Route Hijacking occurs in a number of ways:

**Prefix Hijacking:** An AS can advertise IP prefixes that it does not legitimately own. Attacker can intercept traffic for those prefixes.

**AS Path Hijacking:** In this scenario, an AS modifies the AS path of a route advertisement to attract traffic that would normally pass through another AS. This can lead to malicious traffic interception or disruption.

**Misconfiguration:** A simple configuration error can cause large-scale traffic redirection that affects the internet connectivity.

RBFS BGP implements RPKI-RTR based prefix validation mechanism that verifies the authenticity of route announcements before they are accepted and propagated.

## Understanding BGP RPKI-RTR Validation Implementation

Resource Public Key Infrastructure (RPKI) is a security framework to protect BGP routes from specific types of attacks like route hijacking and misconfigurations. It provides a way to verify the origin AS of BGP routes, ensuring that only authorized ASs are allowed to advertise specific IP prefixes. It achieves this by cryptographically associating IP address allocations (both IPv4 and IPv6 prefixes) with their rightful owner ISPs or enterprises.

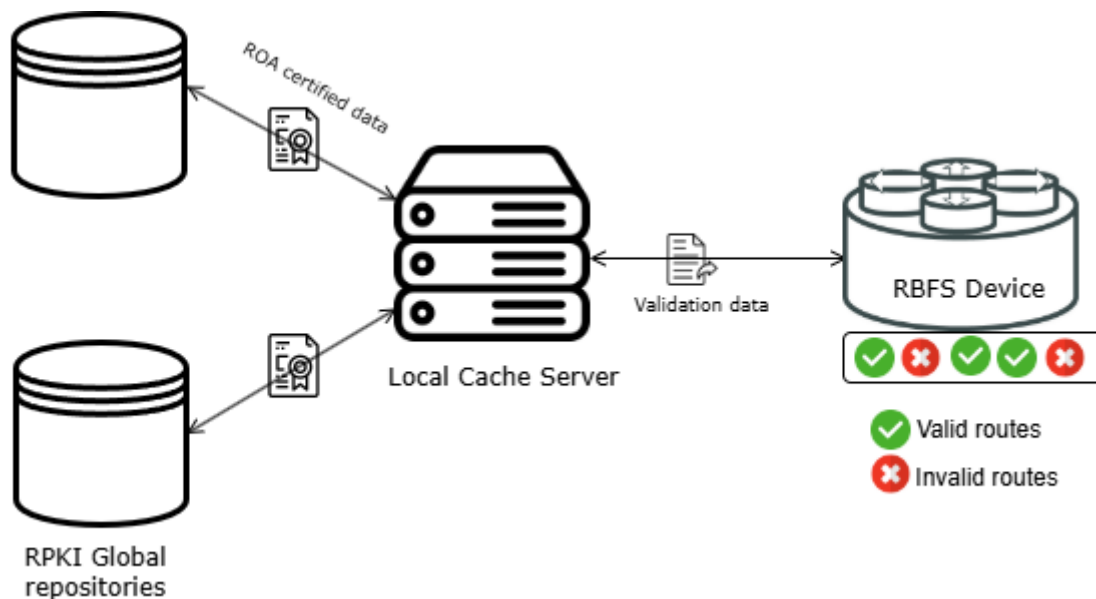

## Key Components of the Validation Mechanism

### Global RPKI Repository

Global RPKI servers are maintained by Regional Internet Registries and other trusted entities. These servers contain cryptographic certificates and Route Origin Authorizations (ROAs) for IP prefixes and ASNs. This is the authoritative source



where the reliable information about IP address ownership.

## Local Cache Server

ISPs deploy local cache servers, which are configured to regularly synchronize with global RPKI repositories, mirroring the latest ROAs and certified data. The local cache servers serve as intermediaries between the global repository and RBFS devices.

## RBFS Device

Once configured, RBFS device establishes secure communication channel with the local cache server for fetching the data using the RTR protocol. Once fetched, the RPKI data is stored locally within the RBFS system. Data are stored in a data table with entries that correspond to valid route origin authorizations. It allows quick lookups for route validation when the device receives a new prefix announcement from a BGP peer.

## How RPKI Validation Works

- **RPKI Data Repos:** Network operators create ROAs which cryptographically bind an IP prefix with an authorized ASN. ROAs are stored in global RPKI repositories which are trusted sources are accessible globally. Local caches servers access the data and stores the verified data.
- **RPKI Data:** RBFS retrieves of data from cache servers. After establishing a validation session with a cache server, RBFS periodically sends reset queries at refresh intervals. These queries request the complete set of records from the cache. When RBFS receives an end-of-data (EOD) PDU, it performs garbage collection to remove outdated records. RBFS maintains the verified data from the local cache servers and stores the data within the system.
- **Route Announcement:** When a new prefix is advertised from a peer, RBFS receives the advertisement.
- **Validation:** RBFS looks up and verifies the ROA to see if the origin AS in the BGP route matches the authorized AS in the ROA using data stored in its RPKI data table. The result of this verification can be 'Valid', 'Invalid', or 'Unknown'.
- **Decision:** Based on the configured validation filter ('strict', 'loose', or 'disable'), the RBFS decides whether to accept or reject the route.

Once the route is validated, RBFS follows decision process as follows:

- **Valid Routes:** Valid routes are installed into the routing table and used for traffic forwarding.
- **Invalid Routes:** Invalid routes are discarded.
- **Unknown:** Routes that are not found in the RPKI data will be accepted if you have configured the filter option as **loose**. Otherwise, this will be discarded.

This entire process ensures that only verified and authorized routes are propagated within the routing tables.



IP prefixes may change any time. Once configured, an RBFS device continuously validates prefixes in real-time when new BGP route announcements arrive. If the RPKI data changes (for example, a new ROA is added or updated), the RBFS device needs to revalidate routes which were accepted or rejected previously. This ensures that only routes verified through RPKI are accepted and malicious route announcements are rejected.

## Shared Validation Databases

RBFS allows BGP prefixes in one instance to use the validation database from another VRF instance. It allows for sharing the validation database between routing instances within the system. When a prefix is received in a BGP update, the receiving BGP instance checks its validity by querying the shared database.

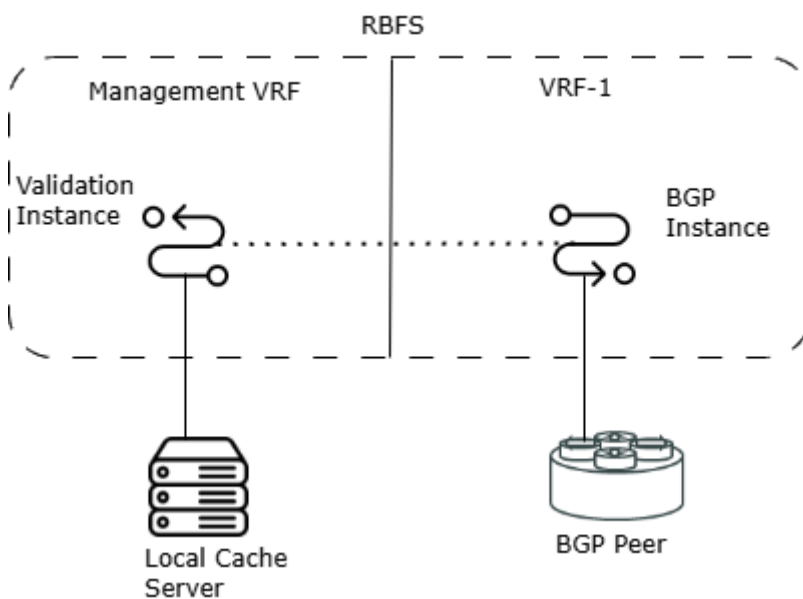

## Timers

With timers, RBFS ensures that the router maintains an up-to-date RPKI validation database. Timers are used to periodically refresh, retry, and expire validation data based on these intervals. RBFS uses timers to maintain synchronization between local cache and RBFS device.

**Refresh Interval:** Specifies how frequently the router should query the Local Cache to refresh its RPKI validation database. Router polls the cache with Reset Query PDU at Refresh intervals.

**Retry Interval:** Specifies how long the router should wait before retrying after a failed Reset Query PDU. Router sends Reset Query PDU upon the failed reset query at retry interval.

**Expire Interval:** Defines how long the router can continue using the current version of the validation database if communication with the Local Cache fails. Router uses the current version of validation database until expire interval.



RBFS clears the validation session and the database after three consecutive unsuccessful reset query attempts at the refresh interval.

## Supported Platforms

Not all features are necessarily supported on each hardware platform. Refer to the *Platform Guide* for the features and the sub-features that are or are not supported by each platform.

### 2.5.2. BGP Prefix Validation Using RPKI-RTR Configuration

#### Configuration Hierarchy

The diagram illustrates the BGP prefix validation mechanism configuration hierarchy.

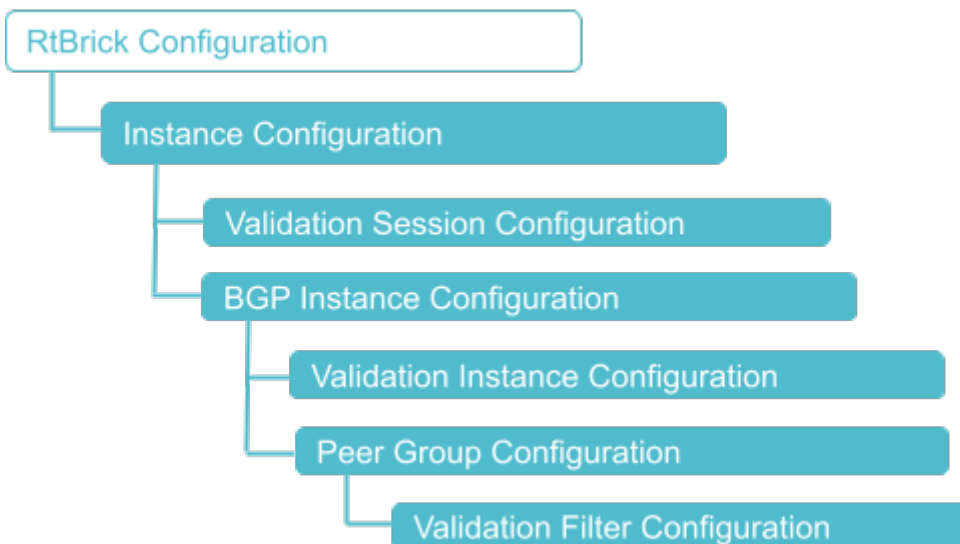

## Configuration Syntax and Commands

The following sections describe the BGP RPKI prefix validation configuration syntax and commands.

### Configure Validation Session with RPKI Local Cache

The following configuration commands are used to define validation session on an RBFS device. It specifies different session parameters such as cache IP address, update source, port, and preference.

In scenarios where multiple caches are available, the system employs a deterministic method for selecting the preferred cache. The cache preference method provides a way to determine which cache should be used based on configurable priorities.

#### Cache Preference:

1. When a preference is configured, the cache with the numerically lower preference value is selected.
2. If no preference is configured, or two caches have the same preference value, the selection follows these rules:

Among IPv4 caches, the cache with the higher IP address is preferred.

Among IPv6 caches, the cache with the higher IP address is preferred.

Between IPv4 and IPv6 caches, the IPv4 cache takes precedence over IPv6.

## Syntax

**set instance** <instance-name> **protocol validation session** [IPv4|IPv6] <cache-address> <update-source>

Attribute	Description
cache-address	Cache server IP address.
update-source	Source IP address.
port	Port number used for the RPKI local cache. Range 1 - 65535
preference	Enables RBFS to select the validated route record from the preferred cache. Range 1 - 255. A numerically lower preference value indicates the higher preference.

### Example: Validation session with the RPKI local cache

```

supervisor@rtbrick.net: cfg> show config instance vrf-blue protocol validation
{
  "rtbrick-config:validation": {
    "session": {
      "ipv4": [
        {
          "cache-address": "192.168.5.50",
          "update-source": "192.168.5.20",
          "port": 3323,
          "preference": 100
        }
      ],
      "ipv6": [
        {
          "cache-address": "192:168:5::50",
          "update-source": "192:168:5::20",
          "port": 3323,
          "preference": 10
        }
      ]
    }
  }
}

```

The preceding configuration sets up RPKI validation for both IPv4 and IPv6 routes in BGP. IPv4 session connects the router to an RPKI cache server with the RTR protocol, using the specified cache server IP address 192.168.5.50. The update-source, that is source IP address, is specified to 192.168.5.20 for the IPv4 session. The port number that is used for RTR communication is specified to '3323' for the

session.

For the IPv6 session, the cache server IP address is specified to 192:168:5::50 and the source IP is specified 192:168:5::20. The port number is specified 3323 that is used for RTR communication.

The preference value for the IPv4 session is set to 100, while the preference value for the IPv6 session is set to 10. The preference value determines which session is prioritized when both sessions are available. A lower numerical preference value indicates a higher preference. In this scenario, the IPv6 session has a higher preference because it has a lower value, meaning that the IPv6 session will take priority over the IPv4 session.

## Configure BGP Validation Instance

### Syntax

**set instance** <instance-name> **protocol bgp validation-instance** <validation-instance>

Attribute	Description
<validation-instance>	Validation instance name.

Example: Validation Instance configuration

```

supervisor@rtbrick.net: cfg> show config instance default protocol bgp validation-
instance
{
  "rtbrick-config:validation-instance": "vrf-blue"
}
    
```

The configuration sets up 'vrf-blue' as the validation instance.

## Configure BGP Validation Filter

Validation filter can be configured under a specific BGP peer group.

### Syntax

**set instance** <instance-name> **protocol bgp peer-group** <pg-name> **validation-filter** [strict|loose|disable]

Attribute	Description
strict	BGP accepts only the valid routes.
loose	BGP accepts both valid routes and unknown routes. But it rejects routes with invalid RPKI data.
disable	No route validation is performed. Routes are installed based on the BGP route selection process.

### Example: Validation filter configuration

```

supervisor@rtbrick.net: cfg> show config instance default protocol bgp peer-group
P2 validation-filter
{
  "rtbrick-config:validation-filter": "loose"
}

```

The configuration defines the validation filter. The validation filter is defined as 'loose' for the configuration that means BGP can accept both valid routes and unknown routes, but it rejects routes with invalid RPKI data.

## 2.5.3. BGP Route Validation with RPKI-RTR Operational Commands

### BGP RPKI-RTR Show Commands

The BGP RPKI-RTR show commands provide detailed information about the BGP RPKI-RTR route validation operations.

#### Prefix Validation

The `show validation` command displays detailed validation information.

#### Syntax:

`show validation <option>`

Option	Description
cache-in	Displays prefix information per cache IP and source IP.

Option	Description
database	Displays information related to the validation database.
session	Provides details about validation sessions.

### Validation Session

The `show validation session` command and options provide information about the TCP session information between RBFS and the local caches.

#### Syntax:

`show validation session <option>`

Option	Description
-	Without any option, it displays information about all the validation session.
cache	Displays validation session information filtered by a specific cache address.
detail	Provides detailed information about each validation session.
instance	Displays validation session information for a specific instance.
source	Displays validation session information filtered by a specific source IP address.

#### Example: Validation session

```

supervisor@rtbrick.net: cfg> show validation session
Instance: vrf-blue
  Cache                               Source                               State      Up/Down
Time      IPv4 Rcvd      IPv6 Rcvd
  192.168.5.50                192.168.5.20                Established
0d:00h:34m:12s                4048744                    986282
  192:168:5::50                192:168:5::20                Established
0d:00h:34m:12s                4048734                    986261
    
```

### Validation Cache-in

The `show validation cache-in` command provides cache information.



**Syntax:****show validation cache-in** <option>

The show command and options provide detailed information about the received validation route records from the local caches.

Option	Description
-	Without any option, it displays information about the prefix validation data for all caches and source IPs.
afi	Filters the cache-in validation data based on the address family, such as IPv4 or IPv6.
cache	Displays validation information related to a specific cache address.
instance	Filters the validation data for a specific instance.
prefix	Displays validation information for a specific prefix.

Example: Information for the specific cache.

```

supervisor@rtbrick.net: cfg> show validation cache-in instance default cache
10.1.1.2
Instance: default  AFI: ipv4
  Cache IP: 10.1.1.2  Source IP: 10.1.1.1  Total Prefixes: 443092
  Prefix                As Num      Max Len
  1.0.0.0/24            13335       24
  3.0.0.0/10            16509       24
  3.0.0.0/15            16509       24
  5.0.0.0/19            29256       19
  20.0.0.0/11           8075        11
  23.0.0.0/12           20940       12
  23.0.0.0/24           20940       24
  24.0.0.0/12           7922        12
  24.0.0.0/16           33659       16
  27.0.0.0/22           16509       24
  31.0.0.0/16           8374        16
  <...>

```

**Validation Database**

The validation database contains preferred validation route records based the cache preference. The **show validation database** provides detailed information about the validation database, which is used for prefix validation.

**Syntax:**

## show validation database <option>

Option	Description
-	Without any option, it displays the information about all validation databases.
afi	Filters the validation database based on the address family, such as IPv4 or IPv6.
as-num	Displays validation information for a specific Autonomous System (AS).
cache	Displays database entries associated with a specific cache address.
instance	Displays database information for a specific instance.
prefix	Filters the database to show validation details for a specific prefix.
summary	Provides a summary of the validation database.

### Example: Validation database information

```

supervisor@S1-STD-1-1012>bm14-tst.fsn.rtbrick.net: cfg> show validation database
Instance: vrf-blue, AFI: ipv4
  Prefix                As Num    Max Len    Cache
  1.0.0.0/24            13335     24         192:168:5::50
  3.0.0.0/10            16509     24         192:168:5::50
  3.0.0.0/15            16509     24         192:168:5::50
  5.0.0.0/19            29256     19         192:168:5::50
  20.0.0.0/11           8075      11         192:168:5::50
  23.0.0.0/12           20940     12         192:168:5::50
  23.0.0.0/24           20940     24         192:168:5::50
    
```

### Example: Validation database information for a specific AS number.

```

supervisor@rtbrick.net: cfg> show validation database as-num 5089
Instance: vrf-blue, AFI: ipv4
  Prefix                As Num    Max Len    Cache
  80.0.0.0/13           5089      17         192:168:5::50
  82.0.0.0/12           5089      12         192:168:5::50
  82.0.0.0/13           5089      13         192:168:5::50
  82.0.0.0/14           5089      14         192:168:5::50
  86.0.0.0/11           5089      11         192:168:5::50
  86.0.0.0/13           5089      13         192:168:5::50
  86.0.0.0/14           5089      14         192:168:5::50
  86.0.0.0/15           5089      15         192:168:5::50
  86.0.0.0/16           5089      16         192:168:5::50
  86.1.0.0/16           5089      16         192:168:5::50
    
```

## Example: Validation database summary

```
supervisor@rtbrick.net: cfg> show validation database summary
Instance: vrf-blue
IPv4 Prefix: 452282
IPv6 Prefix: 113149
```

## Clear Commands

### Clear Validation Session

The `clear validation session` command and options are used to remove or reset data related to validation session.

#### Syntax:

**clear validation session** <option>

Option	Description
all	Resets all existing validation sessions (without clearing the database).
all soft	Refreshes the only the validation database by sending a reset query to the cache.
instance	Resets validation sessions per instance.

#### Example Commands:

```
clear validation session all
clear validation session all soft
clear validation session instance vrf-blue
clear validation session instance vrf-blue 192.168.5.50 source 192.168.5.20 soft
```

### Clear Validation Database

The `clear validation database` command is used to remove entries in the validation database.

#### Syntax:

**clear validation database** <option>

Option	Description
all	Clears all entries in the validation database.
instance	Clears validation database for a specific instance.

Example Commands:

```
clear validation database all
clear validation database instance vrf-blue
clear validation database instance vrf-blue 192.168.5.50 source 192.168.5.20
```

## 2.6. IS-IS

### 2.6.1. IS-IS Overview

IS-IS, or Intermediate System to Intermediate System, is an open standard routing protocol. ISO published the standard as a way to route datagrams as part of their OSI stack. IETF later republished the standard, and added IP route support.

It is a link-state routing protocol, similar to OSPF. It forms neighbor adjacencies, has areas, exchanges link-state packets, builds a link-state database and runs the Dijkstra SPF algorithm to find the best path to each destination, which is installed in the routing table.

IS-IS in RBFS supports segment routing based on RFC 8667. IS-IS Segment Routing enhances the IS-IS protocol by introducing new TLVs to carry segment routing information within IS-IS protocol packets. It introduces Segment IDs (SIDs) to represent different types of segments, such as node SIDs and adjacency SIDs.



| RFC and draft compliance are partial except as specified.

### Supported Platforms

Not all features are necessarily supported on each hardware platform. Refer to the *Platform Guide* for the features and the sub-features that are or are not supported by each platform.

### 2.6.2. IS-IS Configuration

## Configuration Hierarchy

The diagram below illustrates the IS-IS configuration hierarchy.

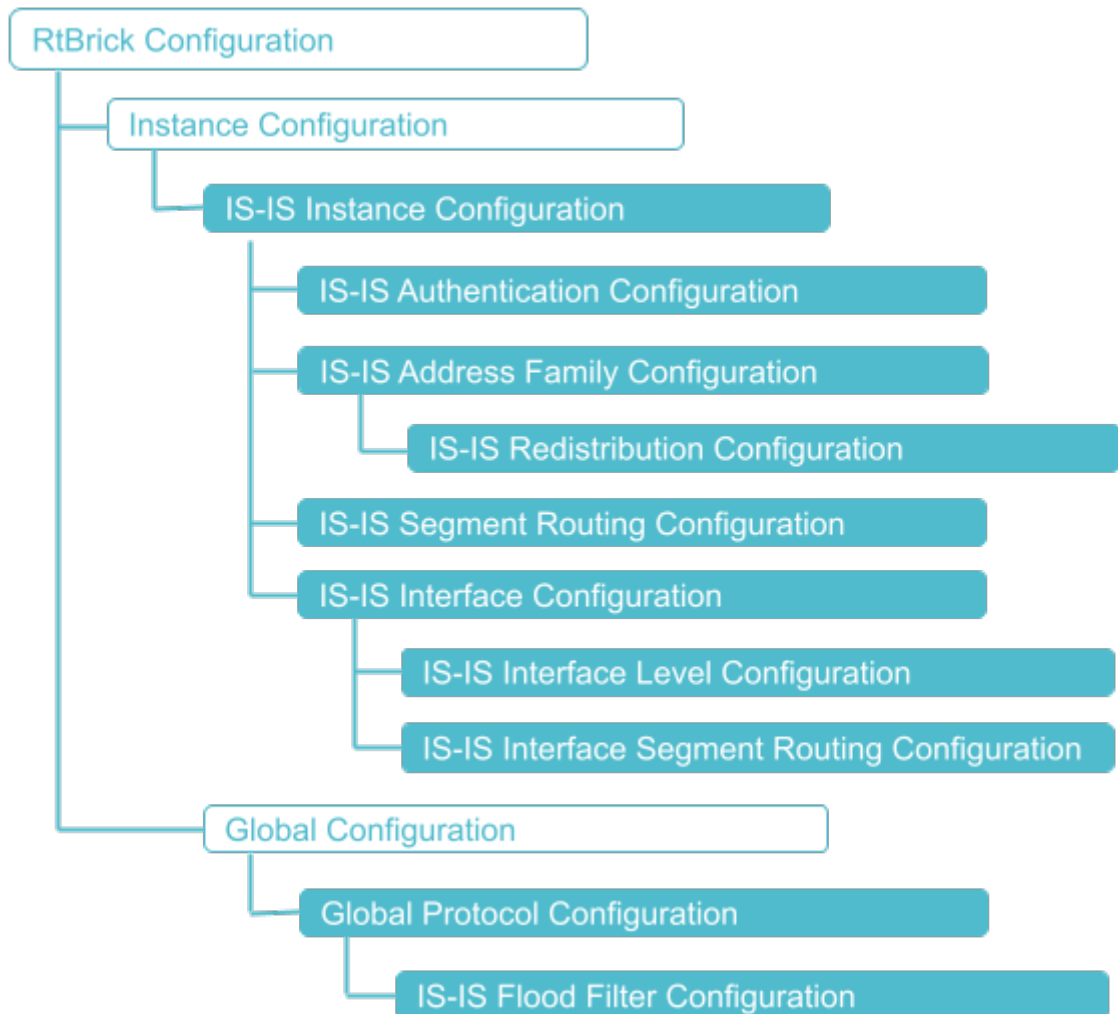

## Configuration Syntax and Commands

The following sections describe the IS-IS configuration syntax and commands.

### Instance Configuration

The instance configuration hierarchy includes parameters that are required for or used by IS-IS.

Syntax:

**set instance** <instance-name> **protocol isis** <attribute> <value>

Attribute	Description
<name>	Name of the IS-IS instance
area <area>	IS-IS area-address. The area can be represented in 1, 3, 5, 13 bytes format.
authentication <...>	Specifies the authentication scheme for IS-IS. Refer to section <a href="#">IS-IS Authentication Configuration</a> for the IS-IS authentication configuration details.
holding-time <holding-time>	<p>Specifies how long a neighbor should consider this routing device to be operative without receiving another hello packet.</p> <p>Default value: 30 seconds</p> <p>Range: 3 to 180 seconds</p>
hostname <hostname>	Specifies the hostname mapped to the system identifier.
ignore-attached-bit [true/false]	This configuration allows you to enable the routing device to ignore the attached bit on incoming Level 1 link-state PDUs. If the attached bit is ignored, no default route, which points to the routing device which has set the attached bit, is installed.
interface <...>	Name of the interface. Refer to section <a href="#">Configuring IS-IS Interface</a> for the interface configuration details.
ipv6-disable [true/false]	Specifies whether the ipv6-disable configuration is enabled or not. When you set this value to "true", it indicates that IPv6 configuration is disabled.
[level-1/level-2] address-family <...>	Protocol ISIS level-1/level-2 address-family configuration. Refer to section <a href="#">IS-IS Address-Family Configuration</a> for the address family configuration details.
level1-to-level2 route-leak [enable/disable]	Specifies whether the level1-to-level2 route-leak is enabled or not. When set to disable, IS-IS will not leak routing information from a Level 1 area to a Level 2 area. By default, this option is enabled.

Attribute	Description
isp-lifetime <isp-lifetime>	IS-IS link-state PDUs maximum lifetime. Default value: 65535 seconds
multipath <multipath>	Load sharing among multiple ISIS paths. Default value: 256
no-mpls-transit-path [true/false]	When set to true, IS-IS will not install segment routing transit path. Default: false
overload [true/false]	When set to true, IS-IS overload bit is set. Default: false
router-id <router-id>	ISIS router identifier (ipv4 format: A.B.C.D)
system-id <system-id>	Specifies the system ID of the device.

### Example 1: IS-IS Instance Configuration

```

supervisor@rtbrick>spinel: cfg>show config instance default protocol isis
{
  "rtbrick-config:isis": {
    "system-id": "1921.6800.1001",
    "area": [
      "49.0001/24"
    ],
    "hostname": "isr1",
    <...>
  }
}

```

### Example 2: Disabling IS-IS Route Leaking from a Level 1 Area to a Level 2 Area

```

supervisor@rtbrick>spinel: cfg> show config instance default protocol isis level1-
to-level2
{
  "rtbrick-config:level1-to-level2": {
    "route-leak": "disable"
  }
}

```

## IS-IS Authentication Configuration

### Syntax:

**set instance** <instance-name> **protocol isis authentication** [**level-1** | **level-2**] <attribute> <value>

Attribute	Description
check [disable / enable]	Specifies an authentication check to reject PDUs that do not match the type or key requirements. You can enable or disable the authentication check.
key-id1 <key-id1> / key-id2 <key-id2>	The key ID allows you to specify the key identifiers for level-1/level-2 authentication.
key1-encrypted-text <key1-encrypted-text> / key2-encrypted-text <key2-encrypted-text>	Authentication key1 and key 2 encrypted text
key1-plain-text <key1-plain-text> / key2-plain-text <key2-plain-text>	The level-1/level-2 authentication keys specify the authentication keys (passwords) that are used by the neighboring routing devices to verify the authenticity of packets sent from this interface. For the key to work, you also must include the authentication-type statement.
type	<p>Enables you to specify the authentication scheme for IS-IS. If you enable authentication, you must specify a password by including the authentication-key statement.</p> <p>The following authentication types are supported:</p> <ul style="list-style-type: none"> <li>• clear_text</li> <li>• md5</li> <li>• sha1</li> </ul>

```

supervisor@rtbrick>spinel: cfg> show config instance default protocol isis
authentication
{
  "rtbrick-config:authentication": {
    "level-1": {
      "type": "md5",
      "key1-encrypted-text": "$24a6f10525a11077bec3b451be8855877"
    },
    "level-2": {
      "type": "md5",
      "key1-encrypted-text": "$2d787015bf84f3b58d5fd393a96c9639c"
    }
  }
}

```



## IS-IS Address-Family Configuration

The address-family command allows you to enable the address families that IS-IS will route and configure settings that are specific to that address family.

### Syntax:

```
set instance <instance-name> protocol isis [level-1 | level-2] address-family
<attribute> <value>
```

Attribute	Description
<afi>	Address family identifier (AFI). Supported values: ipv4, ipv6
<safi>	Subsequent address family identifier (SAFI). Supported values: unicast or labeled-unicast

## Configuring Route Redistribution

### Syntax:

```
set instance <instance-name> protocol isis [level-1 | level-2] address-family
<afi> <safi> redistribute <attribute> <value>
```

Attribute	Description
<afi>	Address family identifier (AFI). Supported values: ipv4, ipv6
<safi>	Subsequent address family identifier (SAFI). Supported values: unicast or labeled-unicast
redistribute <protocol>	Specifies the source from which the routes are to be redistributed from. The available options include <b>arp-nd</b> , <b>bgp</b> , <b>bgp-local</b> , <b>bgp-local-origin</b> , <b>direct</b> , <b>igmp</b> , <b>ospf</b> , <b>l2tpv2</b> , <b>ldp</b> , <b>local</b> , <b>pim</b> , <b>ppp</b> , <b>rib</b> , and <b>static</b> .
redistribute <protocol> <policy>	Specifies the name of the policy map. The redistribute attach point allows routes from other sources to be advertised by IS-IS. Policy can be applied only to the routes that are redistributed from other sources to IS-IS. The support for inter-level leaking through policy is unavailable.

## Example: IS-IS address-family configuration

```
supervisor@rtbrick>spinel: cfg> show config instance default protocol isis level-1
{
  "rtbrick-config:level-1": {
    "address-family": [
      {
        "afi": "ipv4",
        "safi": "unicast",
        "redistribute": [
          {
            "source": "static",
            "policy": "filter-link-address"
          }
        ]
      },
      {
        "afi": "ipv6",
        "safi": "unicast",
        "redistribute": [
          {
            "source": "static",
            "policy": "filter-link6-address"
          }
        ]
      }
    ]
  }
}
```

## Segment Routing Configuration

IS-IS segment routing extensions allow to advertise labels with prefixes.

RBFS currently supports the following IS-IS segment routing features:

- MPLS data plane
- IPv4 prefixes (TLV 135) and IPv6 prefixes (TLV 236)
- Prefix SID with node flag (Node SID) on loopback interface
- Anycast SID
- A single global SRGB block
- Adjacency SIDs

### Syntax:

```
set instance <instance-name> protocol isis segment-routing <attribute>
<value>
```

Attribute	Description
srgb base <srgb base>	Specifies the segment routing global block (SRGB) in source packet routing. SRGB is used for prefix SIDs. Supported MPLS label values are 0 - 1048575. The reserved MPLS label range is 0 - 15. In RBFS, BGP uses the label range 20000 - 100000. It is recommended to assign label values outside of these reserved ranges to avoid conflicts.
srgb range <srgb range>	IS-IS system range of labels from the base label.
srlb base <srlb base>	Specifies the segment routing local block (SRLB) in source packet routing. SRLB is used for adjacency SIDs. Supported MPLS label values are 0 - 1048575. The reserved MPLS label range is 0 - 15. In RBFS, BGP uses the label range 20000 - 100000. It is recommended to assign label values outside of these reserved ranges to avoid conflicts.
srlb range <srlb range>	IS-IS system range of labels from the base label.

### Example: IS-IS Segment Routing Configuration

```

supervisor@rtbrick>spinel: cfg> show config instance default protocol isis
segment-routing
{
  "rtbrick-config:segment-routing": {
    "srlb": {
      "base": 2000,
      "range": 1000
    },
    "srgb": {
      "base": 1000,
      "range": 1000
    }
  }
}

```

### Configuring IS-IS Interface

By default, there are no interfaces associated with IS-IS. You must configure at least one IS-IS interface for IS-IS adjacency formation.

#### Syntax:

**set instance** <instance> **protocol isis interface** <name> <attribute> <value>

Attribute	Description
<name>	Specifies the name of the IS-IS interface.
flood-filter <flood-filter>	Specifies the IS-IS flood filter name
hello-interval	<p>Specifies IS-IS system interface hello interval.</p> <div style="border-left: 1px solid black; padding-left: 10px; margin-left: 20px;"> <p>To configure hello-interval, the user can either configure holding-time/hello-interval under interface or hello-interval under level [broadcast interface only].</p> <p>The order of priority, from highest to lowest, is as follows:</p> <ul style="list-style-type: none"> <li>* For Broadcast interface type: hello-interval under interface level 1/2 &gt; hello-interval under interface &gt; holding-time under instance</li> <li>* For Point-to-Point interface type: hello-interval under interface &gt; holding-time under instance</li> </ul> </div>
level-1 / level-2	Specify IS-IS interface level configuration. Refer to section <a href="#">IS-IS Interface Level Configuration</a> for the IS-IS interface level configuration details.
lsp-interval <lsp-interval>	IS-IS system interface LSP interval. Default value: 100
passive [true / false]	Enable interface in passive mode. Default: false
system-id <system-id>	Interface level system id
type [broadcast / point-to-point]	<p>Specifies the type of the IS-IS system interface. Default: point-to-point.</p> <p>broadcast—Specifies a broadcast (or LAN) interface. point-to-point—Specifies a point-to-point interface.</p>
ldp-synchronization [enable / disable]	Enable LDP IGP synchronization. Default: disable

Example 1: IS-IS Interface Configuration

```

supervisor@rtbrick>spinel: cfg> show config instance default protocol isis
interface
{
  "rtbrick-config:interface": [
    {
      "name": "if1-0/0/2/0",
      "type": "point-to-point",
      "passive": "false",
      "level-1": {
        "snmp-authentication": "disable",
        "hello-authentication": "disable"
      },
      "level-2": {}
    },
    {
      "name": "if1-0/0/2/1",
      "flood-filter": "spinel_lsrl_flood_filter",
      "type": "broadcast",
      "lsp-interval": 200,
      "ldp-synchronization": "enable",
      "level-1": {
        "snmp-authentication": "enable",
        "hello-authentication": "enable",
        "metric": 1000,
        "adjacency-disable": "false",
        "priority": 100,
        "hello-interval": 20
      },
      "level-2": {
        "priority": 100,
        "hello-interval": 20
      }
    },
    {
      "name": "lo-0/0/0/0",
      "passive": "true",
      "segment-routing": {
        "ipv4": {
          "index": 100
        },
        "ipv6": {
          "index": 102
        }
      },
      "level-1": {},
      "level-2": {}
    }
  ]
}

```

## Example 2: IS-IS Interface Level Flood Filter Configuration

```

supervisor@rtbrick>spinel: cfg> show config instance default protocol isis
interface if1-0/0/2/1 flood-filter
{
  "rtbrick-config:flood-filter": "spinel_lsrl_flood_filter"
}

```

### Example 3: IS-IS Interface Configuration with enabled LDP synchronization

```

supervisor@rtbrick>spine1: cfg> show config instance default protocol isis
interface if1-0/0/2/1 ldp-synchronization
{
  "rtbrick-config:ldp-synchronization": "enable"
}
    
```

### Example 4: IS-IS Interface Configuration for a Broadcast Interface.

```

supervisor@rtbrick>spine1: cfg> show config instance default protocol isis
interface if1-0/0/2/1 type
{
  "rtbrick-config:type": "broadcast"
}
    
```

## IS-IS Interface Level Configuration

### Syntax:

**set instance** <instance> **protocol isis interface** <name> [**level-1** | **level-2**] <attribute> <value>

Attribute	Description
adjacency-disable [true/false]	Specify the level-1/level-2 adjacency on an interface. Default: false.
hello-authentication [disable/enable]	Authentication on hello packets.
hello-interval	Specifies the length of time between the sending of IS-IS hello PDUs. Default: 10. The hello interval can be set for both <b>broadcast</b> and <b>point-to-point</b> interfaces that are configured for Levels 1 and 2.  NOTE:
priority	Specify the priority on a broadcast interface. Default: 64.
metric <metric>	Level-1/Level-2 metric on an interface. Default: 1000000.
snp-authentication [enable/disable]	Authentication on CSNP/PSNP packets.

## Example 1: IS-IS Interface Level Configuration

```

supervisor@rtbrick>spinel: cfg> show config instance default protocol isis
interface ifl-0/0/2/1
{
  "rtbrick-config:interface": [
    {
      "name": "ifl-0/0/2/1",
      "flood-filter": "spinel_lsrl_flood_filter",
      "type": "broadcast",
      "lsp-interval": 200,
      "ldp-synchronization": "enable",
      "level-1": {
        "snp-authentication": "enable",
        "hello-authentication": "enable",
        "metric": 1000,
        "adjacency-disable": "false",
        "priority": 100,
        "hello-interval": 20
      },
      "level-2": {
        "priority": 100,
        "hello-interval": 20
      }
    }
  ]
}

```

## Interface-level Segment Routing Configuration

### Syntax:

**set instance** <instance> **protocol isis interface** <name> **segment-routing** <attribute> <value>

Attribute	Description
segment-routing [ipv4 / ipv6] anycast-index <anycast-index>	Anycast index segment-ID. The prefix SIDs and anycast SIDs are applied on loopback interface only.
segment-routing [ipv4 / ipv6] index <index>	Prefix index segment ID.
segment-routing point-to-point [ipv4 / ipv6] adjacency-index <adjacency-index>	Adjacency index segment-ID. The adjacency SIDs are applied on active IS-IS interfaces on which adjacencies are established.

Example 1: IS-IS Interface Level Segment Routing Configuration for Prefix and

## Anycast SID

```

supervisor@rtbrick>spinel: cfg> show config instance default protocol isis
interface
{
  "rtbrick-config:instance": [
    {
      "name": "default",
      "protocol": {
        "isis": {
          "interface": [
            {
              "name": "lo-0/0/0",
              "segment-routing": {
                "ipv4": {
                  "index": 100
                },
                "ipv6": {
                  "index": 200
                }
              }
            },
            {
              "name": "lo-0/0/1",
              "segment-routing": {
                "ipv4": {
                  "anycast-index": 110
                },
                "ipv6": {
                  "anycast-index": 210
                }
              }
            }
          ]
        }
      }
    }
  ]
}

```

## Example 2: IS-IS Interface Level Segment Routing Configuration for Adjacency SID

```

supervisor@rtbrick>spinel: cfg> show config instance default protocol isis
interface ifl-0/0/2/0 segment-routing
{
  "rtbrick-config:segment-routing": {
    "point-to-point": {
      "ipv4": {
        "adjacency-index": 111
      },
      "ipv6": {
        "adjacency-index": 112
      }
    }
  }
}

```



```
}
```

## IS-IS Global Configuration

### IS-IS Flood Filter Configuration

In IS-IS, by default all routers flood link-state packets, so that all routers will have a complete topology view. IS-IS flood filters allow to modify this behavior and limit the exchange of LSPs. For example, if two spine routers in a spine/leaf fabric are symmetrically connected to two upstream label-switch routers (LSR) like shown in the figure below, you can use a flood filter to not advertise LSPs learned from LSR A back to the LSR B via the second spine switch.

The flooding filter configuration is part of the global configuration hierarchy and therefore you can configure filtering globally, i.e. not per instance, so that the filter configurations can be reused across instances.

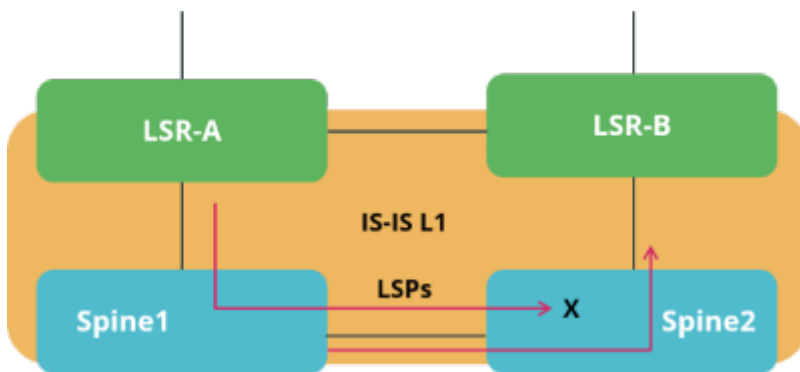

#### Syntax:

**set global protocol isis flood-filter** <filter-name> <ordinal> <attribute> <value>

Attribute	Description
<filter-name>	Filter-name which binds a flooding filter to an IS-IS interface
<ordinal>	Number to filter rule
action [block/flood]	Action required to flood or not
ordinal-name <ordinal-name>	Name for the filter rule
system-id <system-id>	IS-IS instance system-id

Attribute	Description
system-id-mask <system-id-mask>	System ID mask on which the filter should match

### Example: IS-IS Flood Filter Configuration

```

supervisor@rtbrick>spine1: cfg> show config instance default protocol isis
interface if1-0/0/2/1 flood-filter
{
  "rtbrick-config:flood-filter": "spine1_lsr1_flood_filter"
}
    
```

## 2.6.3. IS-IS Operational Commands

### IS-IS Show Commands

The IS-IS show commands provide detailed information about the IS-IS protocol operation and IS-IS routes.

#### IS-IS Overview

##### Syntax:

##### show isis overview

Option	Description
-	Without any option, this command displays a summary of all the IS-IS instances

### Example: Summary view of all the IS-IS instances

```

supervisor@rtbrick>spine1: op> show isis overview
Instance: default
  System ID: 1921.6800.1001
  System hostname: isr1
  Areas: 49.0001/24
  Neighbor hold time: 30 sec
  LSP life time: 65535 sec
  Overload bit set: False
  SRGB base: 1000
  SRGB range: 1000
  SRGB label values: 1000 - 1999
  SRLB base: 2000
  SRLB range: 1000
  SRLB label values: 2000 - 2999
    
```

Authentication: Level 1: md5, Level 2: md5

## IS-IS Interface

### Syntax:

**show isis interface** <option>

Option	Description
-	Without any option, this command displays a summary of all the IS-IS interfaces
instance	Displays IS-IS interface information for an instance
statistics	Displays IS-IS interface statistics information
detail	Displays detailed output for all interfaces.

### Example 1: Summary view of the IS-IS interfaces

```

supervisor@rtbrick>spinel: op> show isis interface
Instance: default
  Interface      Level  Adjacencies  Metric  Type           Passive  LDP-
sync
  lo-0/0/0/0     1      0            1000000 loopback       1      -
  lo-0/0/0/0     2      0            1000000 loopback       1      -
  if1-0/0/2/0    2      1            1000000 point-to-point 0      -
  if1-0/0/2/1    1      2            1000000 broadcast     0      -
  if1-0/0/2/1    2      2            1000000 broadcast     0      -
    
```

### Example 2: Summary view of the IS-IS interfaces for a specific instance

```

supervisor@rtbrick>spinel: op> show isis interface instance default
Instance: default
  Interface      Level  Adjacencies  Metric  Type           Passive  LDP-sync
  lo-0/0/0/0     1      0            1000000 loopback       1      -
  lo-0/0/0/0     2      0            1000000 loopback       1      -
  if1-0/0/2/0    2      1            1000000 point-to-point 0      -
  if1-0/0/2/1    1      2            1000000 broadcast     0      -
  if1-0/0/2/1    2      2            1000000 broadcast     0      -
    
```

### Example 3: Summary view of the IS-IS interfaces for a specific interface

```

supervisor@rtbrick>spinel: op> show isis interface if1-0/0/2/0
Instance: default
  Interface: if1-0/0/2/0, Level: 1
  Type: point-to-point, Passive: False
  Metric: 1000000
    
```

```

Hello interval: 10 seconds, Hello multiplier: 3, Hold time: 30 seconds
Adjacencies: 1
CNSP in: 0, CNSP out: 2446, CNSP success: 1222, CNSP fail: 0
PSNP in: 0, PSNP out: 0, PSNP success: 0, PSNP fail: 0
LSP in: 0, LSP out: 0, LSP success: 0, LSP fail: 0, LSP in purge: 0 LSP in
auth fail: 0
IIH in: 1134, IIH out: 1138
Interface: if1-0/0/2/0, Level: 2
Type: point-to-point, Passive: False
Metric: 1000000
Hello interval: 10 seconds, Hello multiplier: 3, Hold time: 30 seconds
Adjacencies: 1
CNSP in: 0, CNSP out: 2446, CNSP success: 1222, CNSP fail: 0
PSNP in: 0, PSNP out: 0, PSNP success: 0, PSNP fail: 0
LSP in: 0, LSP out: 0, LSP success: 0, LSP fail: 0, LSP in purge: 0 LSP in
auth fail: 0
IIH in: 1134, IIH out: 1138
    
```

### Example 4: Summary view of the IS-IS interface statistics

```

supervisor@rtbrick>spinel: op> show isis interface statistics
Instance: default
  Interface          Level  CSNP In  CSNP Out  CSNP Fail  PSNP In  PSNP Out  PSNP
Fail LSP In  LSP Out  LSP Fail  IIH In
  IIH Out
  lo-0/0/0/0          1         0         0         0         0         0
0         0         0         0         0
    0
  lo-0/0/0/0          2         0         0         0         0         0
0         0         0         0         0
  if1-0/0/2/0         1         0        2454         0         0         0
0         0         0         0    1138
    1142
  if1-0/0/2/0         2         0        2454         0         0         0
0         0         0         0    1138
    1142
  if1-0/0/2/1         1         0         0         0         0         0
3         1         0    2288
    2285
  if1-0/0/2/1         2         0         0         0         0         0
0         4         1         0    2288    2285
    
```

### Example 5: Detailed output of the IS-IS interface

```

supervisor@rtbrick>spinel: op> show isis interface detail
Instance: default
  Interface: lo-0/0/0/0, Level: 1
  Type: loopback, Passive: True
  Metric: 1000000
  Hello interval: 10 seconds, Hello multiplier: 3, Hold time: 30 seconds
  Adjacencies: 0
  CNSP in: 0, CNSP out: 0, CNSP success: 0, CNSP fail: 0
  PSNP in: 0, PSNP out: 0, PSNP success: 0, PSNP fail: 0
  LSP in: 0, LSP out: 0, LSP success: 0, LSP fail: 0, LSP in purge: 0 LSP in
  auth fail: 0
  IIH in: 0, IIH out: 0
    
```

```

Interface: lo-0/0/0/0, Level: 2
  Type: loopback, Passive: True
  Metric: 1000000
  Hello interval: 10 seconds, Hello multiplier: 3, Hold time: 30 seconds
  Adjacencies: 0
  CNSP in: 0, CNSP out: 0, CNSP success: 0, CNSP fail: 0
  PSNP in: 0, PSNP out: 0, PSNP success: 0, PSNP fail: 0
  LSP in: 0, LSP out: 0, LSP success: 0, LSP fail: 0, LSP in purge: 0 LSP in
auth fail: 0
  IIH in: 0, IIH out: 0
Instance: default
  Interface: ifl-0/0/2/0, Level: 1
    Type: point-to-point, Passive: False
    Metric: 1000000
    Hello interval: 10 seconds, Hello multiplier: 3, Hold time: 30 seconds
    Adjacencies: 1
    CNSP in: 0, CNSP out: 2460, CNSP success: 1229, CNSP fail: 0
    PSNP in: 0, PSNP out: 0, PSNP success: 0, PSNP fail: 0
    LSP in: 0, LSP out: 0, LSP success: 0, LSP fail: 0, LSP in purge: 0 LSP in
auth fail: 0
    IIH in: 1141, IIH out: 1145
  Interface: ifl-0/0/2/0, Level: 2
    Type: point-to-point, Passive: False
    Metric: 1000000
    Hello interval: 10 seconds, Hello multiplier: 3, Hold time: 30 seconds
    Adjacencies: 1
    CNSP in: 0, CNSP out: 2460, CNSP success: 1229, CNSP fail: 0
    PSNP in: 0, PSNP out: 0, PSNP success: 0, PSNP fail: 0
    LSP in: 0, LSP out: 0, LSP success: 0, LSP fail: 0, LSP in purge: 0 LSP in
auth fail: 0
    IIH in: 1141, IIH out: 1145
<...>

```

### Example 5: Detailed output of an IS-IS interface that supports broadcast

```

supervisor@rtbrick>spinel: op> show isis interface ifl-0/0/2/1
Instance: default
  Interface: ifl-0/0/2/1, Level: 1
    Type: broadcast, Passive: False, Circuit ID: 0x1
    Metric: 1000000, Priority: 64
    Hello interval: 10 seconds, Hello multiplier: 3, Hold time: 30 seconds
    Designated IS: isr6.01(1921.6800.1006.01)
    Adjacencies: 2
    CNSP in: 0, CNSP out: 0, CNSP success: 1238, CNSP fail: 0
    PSNP in: 0, PSNP out: 0, PSNP success: 0, PSNP fail: 0
    LSP in: 3, LSP out: 1, LSP success: 3, LSP fail: 0, LSP in purge: 0 LSP in
auth fail: 0
    IIH in: 2304, IIH out: 2301
  Interface: ifl-0/0/2/1, Level: 2
    Type: broadcast, Passive: False, Circuit ID: 0x1
    Metric: 1000000, Priority: 64
    Hello interval: 10 seconds, Hello multiplier: 3, Hold time: 30 seconds
    Designated IS: isr6.01(1921.6800.1006.01)
    Adjacencies: 2
    CNSP in: 0, CNSP out: 0, CNSP success: 1238, CNSP fail: 0
    PSNP in: 0, PSNP out: 0, PSNP success: 0, PSNP fail: 0
    LSP in: 4, LSP out: 1, LSP success: 4, LSP fail: 0, LSP in purge: 0 LSP in
auth fail: 0
    IIH in: 2304, IIH out: 2301

```

```
supervisor@rtbrick>spinel: op>
```

## IS-IS Neighbor

### Syntax:

**show isis neighbor** <option>

Option	Description
-	Without any option, this command displays a summary of all the IS-IS neighbors
detail	Displays detailed information for IS-IS neighbor
instance	Displays IS-IS neighbor information for an instance

### Example 1: Summary view of the IS-IS neighbor

```
supervisor@rtbrick>spinel: op> show isis neighbor
Instance: default
  Interface      System      Level  State  Type      Up since
Expires
  if1-0/0/2/0    isr6        L1L2   Up     P2P       Thu Jul 25 05:40:05
in 18s 750197us
  if1-0/0/2/1    isr6        L1     Up     Broadcast Thu Jul 25 05:39:58
in 26s 728457us
  if1-0/0/2/1    isr6        L2     Up     Broadcast Thu Jul 25 05:39:58
in 29s 729531us
```

### Example 2: Detailed view of the IS-IS neighbor

```
supervisor@S1-STD-17-1703: cfg> show isis neighbor detail
Instance: default
  System: isr6, Interface: if1-0/0/2/0
  State: Up, Level: L1L2, Adjacency type: P2P
  Hold time: 30.0s, Expiry time: in 29s 780091us
  Local IPv4 address: 16.0.1.1, Remote IPv4 address: 16.0.1.6
  Local IPv6 address: fe80::7807:2dff:fec0:2, Remote IPv6 address:
fe80::7847:eff:fec0:0
  Up since: Thu Jul 25 05:40:05 GMT +0000 2024, Last down reason: NA
  Last transition: 2024-07-25T05:40:05.778348+0000, Number of transitions: 2
  Error counters:
    Level mismatch: 0, Area mismatch: 0, System ID: 0, Subnet mismatch: 0
    Hold timeout: 0, Neighbor down: 0, Interface down: 0, Admin reset: 0
    Interface configuration: 0, Area configuration: 0, Other: 0
  System: isr6, Interface: if1-0/0/2/1
  State: Up, Level: L1L2, Adjacency type: Broadcast
  Hold time: 30.0s, Expiry time: in 24s 779280us
  Priority: 64, Designated IS: 1921.6800.1006.01, SNPA: 7a:47:0e:c0:00:00
  Local IPv4 address: 16.0.2.1, Remote IPv4 address: 16.0.2.6
  Local IPv6 address: fe80::7807:2d00:1c0:2, Remote IPv6 address:
```

```

fe80::7847:e00:1c0:0
  Up since: Thu Jul 25 05:39:58 GMT +0000 2024, Last down reason: NA
  Last transition: 2024-07-25T05:39:58.725007+0000, Number of transitions: 3
  Error counters:
    Level mismatch: 0, Area mismatch: 0, System ID: 0, Subnet mismatch: 0
    Hold timeout: 0, Neighbor down: 0, Interface down: 0, Admin reset: 0
    Interface configuration: 0, Area configuration: 0, Other: 0
<...>

```

### Example 3: Summary view of the IS-IS neighbor for the specified instance

```

supervisor@rtbrick>spinel: op> show isis neighbor instance default
Instance: default
  Interface      System      Level  State  Type      Up since
Expires
  ifl-0/0/2/0   isr6       L1L2   Up     P2P       Thu Jul 25 05:40:05   in
21s 893028us
  ifl-0/0/2/1   isr6       L1     Up     Broadcast Thu Jul 25 05:39:58   in
26s 848320us
  ifl-0/0/2/1   isr6       L2     Up     Broadcast Thu Jul 25 05:39:58   in
24s 845934us
supervisor@rtbrick>spinel: op>

```

### Example 4: Detailed view of the IS-IS neighbor for the specified instance

```

supervisor@rtbrick>spinel: op> show isis neighbor instance default detail
Instance: default
  System: isr6, Interface: ifl-0/0/2/0
  State: Up, Level: L1L2, Adjacency type: P2P
  Hold time: 30.0s, Expiry time: in 21s 155501us
  Local IPv4 address: 16.0.1.1, Remote IPv4 address: 16.0.1.6
  Local IPv6 address: fe80::7807:2dff:fec0:2, Remote IPv6 address:
fe80::7847:eff:fec0:0
  Up since: Thu Jul 25 05:40:05 GMT +0000 2024, Last down reason: NA
  Last transition: 2024-07-25T05:40:05.778348+0000, Number of transitions: 2
  Error counters:
    Level mismatch: 0, Area mismatch: 0, System ID: 0, Subnet mismatch: 0
    Hold timeout: 0, Neighbor down: 0, Interface down: 0, Admin reset: 0
    Interface configuration: 0, Area configuration: 0, Other: 0
  System: isr6, Interface: ifl-0/0/2/1
  State: Up, Level: L1L2, Adjacency type: Broadcast
  Hold time: 30.0s, Expiry time: in 23s 150249us
  Priority: 64, Designated IS: 1921.6800.1006.01, SNPA: 7a:47:0e:c0:00:00
  Local IPv4 address: 16.0.2.1, Remote IPv4 address: 16.0.2.6
  Local IPv6 address: fe80::7807:2d00:1c0:2, Remote IPv6 address:
fe80::7847:e00:1c0:0
  Up since: Thu Jul 25 05:39:58 GMT +0000 2024, Last down reason: NA
  Last transition: 2024-07-25T05:39:58.725007+0000, Number of transitions: 3
  Error counters:
    Level mismatch: 0, Area mismatch: 0, System ID: 0, Subnet mismatch: 0
    Hold timeout: 0, Neighbor down: 0, Interface down: 0, Admin reset: 0
    Interface configuration: 0, Area configuration: 0, Other: 0
<...>

```

## Designated IS (DIS) Election History

In IS-IS broadcast networks, the Designated Intermediate System (DIS) is elected to optimize the distribution of routing information, reducing network overhead by coordinating the flooding of Link State Packets (LSPs) among multiple routers. This ensures efficient and stable network operation. The following command displays the DIS election history in RBFS.

### Syntax:

**show isis dis-election history** <attribute> <value>

Option	Description
-	Without any option, this command displays a summary of all the IS-IS.
instance	Displays DIS history information for the specified instance.
interface <interface-name>	Displays IS-IS DIS history information for the specified interface.
level [level-1/level-2]	Displays IS-IS DIS history information for the specified level.

### Example: Summary view of IS-IS DIS Election History

```

supervisor@rtbrick>spinel: op> show isis dis-election history
Instance: default, Interface: if1-0/0/2/1, Level: 1
Timestamp                DIS                Event
Thu Jul 25 05:39:58 GMT +0000 2024    -                Neighbour
1921.6800.1006 adjacency state changed from Init to Up
Thu Jul 25 05:39:58 GMT +0000 2024    1921.6800.1006.01  Neighbour
1921.6800.1006 DIS changed from 0000.0000.0000.00 to 1921.6800.1006.01
Instance: default, Interface: if1-0/0/2/1, Level: 2
Timestamp                DIS                Event
Thu Jul 25 05:39:58 GMT +0000 2024    -                Neighbour
1921.6800.1006 adjacency state changed from Init to Up
Thu Jul 25 05:39:58 GMT +0000 2024    1921.6800.1006.01  Neighbour
1921.6800.1006 DIS changed from 0000.0000.0000.00 to 1921.6800.1006.01
    
```

## IS-IS Hostname

### Syntax:

**show isis hostname**



Option	Description
-	Without any option, this command displays a summary of all the IS-IS dynamic hostnames

### Example: Summary view of IS-IS hostnames

```

supervisor@rtbrick>spine1: op> show isis hostname
Instance      System-ID      Hostname
default       1921.6800.1001  isr1
default       1921.6800.1006  isr6
default       1921.6800.1006  isr6
supervisor@rtbrick>spine1: op>

```

## IS-IS Database

### Syntax:

**show isis database** <option>

Option	Description
-	Without any option, this command displays all the IS-IS databases
detail	Displays detailed information for IS-IS database
instance	Displays IS-IS database information for an instance
lsp <lsp-id>	Displays a summary of IS-IS database for the specified LSP ID. This command includes an option for entering the system ID part either by hostname or by ID.
[level-1/level-2] lsp	Displays a summary of IS-IS database LSP information for specified level
system <system-id>	Displays a summary of IS-IS database for all LSPs from a system
[level-1/level-2] system	Displays a summary of IS-IS database for all LSPs from a system on the specified level.
[level-1/level-2] detail	Displays detailed information for the specified level

### Example 1: Summary view of the IS-IS Database

```

supervisor@S1-STD-7-7001>bm01-tst.fsn.rtbrick.net: op> show isis database
Instance: default, Level: 1

```

LSP ID	Sequence	Checksum	Lifetime	Overload	Attached
isr1.00-00	0x4	0xe035	52785	0	0
isr6.00-00	0x3	0xe281	52785	0	0
isr6.01-00	0x1	0x4b1a	52778	0	0

Instance: default, Level: 2

LSP ID	Sequence	Checksum	Lifetime	Overload	Attached
isr1.00-00	0x6	0x75af	52785	0	0
isr6.00-00	0x5	0x117e	52785	0	0
isr6.01-00	0x1	0x4b1a	52778	0	0

### Example 2: Summary view of the IS-IS database for the specified LSP

```

supervisor@rtbrick>spine1: op> show isis database lsp 1921.6800.1001.00-00
Instance: default, Level: 1
  LSP ID: isr1.00-00
    Interface:
    LSP Header:
      Sequence: 0x4
      Checksum: 0xe035
      Remaining lifetime: 65535 seconds
      Flags: Attached: 0, Overload: 0
    Packet:
      Length: 182 bytes
      Last received time: 2024-07-25T05:40:05.989755+0000
      Expiry: expires in 14h 39m 11s 284549us
    System ID: 1921.6800.1001
    Dynamic Hostname TLV (137): isr1
    Protocols Supported TLVs (129):
      Network layer protocol ID: IPv6
      Network layer protocol ID: IPv4
    Area Address TLVs (1):
      Area address: 49.0001
    IS Reachability TLVs (22):
      IS neighbor: 1921.6800.1006.00      Metric: 1000000
      IS neighbor: 1921.6800.1006.01      Metric: 1000000
    IPv4 Reachability TLVs (135):
      IPv4 prefix: 16.0.1.0/24      Metric: 1000000      Internal      Up
      IPv4 prefix: 16.0.2.0/24      Metric: 1000000      Internal      Up
      IPv4 prefix: 192.168.1.1/32    Metric: 1000000      Internal      Up
    SID: 100  Flags: Node
    IPv6 Reachability TLVs (236):
      IPv6 prefix: 16:0:1::/64      Metric: 1000000      Internal      Up
      IPv6 prefix: 16:0:2::/64      Metric: 1000000      Internal      Up
      IPv6 prefix: 192:168:1::1/128 Metric: 1000000      Internal      Up
    SID: 102  Flags: Node
    Segment Routing TLVs (242/sub 2):
      SRGB: Base: 1000, Range: 1000, Router ID: 192.168.1.1
    <...>

```

### Example 3: Detailed view of the IS-IS database for level-1

```

supervisor@rtbrick>spine1: op> show isis database level-1 detail
Instance: default, Level: 1
  LSP ID: isr1.00-00
    Interface:
    LSP Header:
      Sequence: 0x4

```

```

Checksum: 0xe035
Remaining lifetime: 52682 seconds
Flags: Attached: 0, Overload: 0
Packet:
  Length: 182 bytes
  Last received time: 2024-07-25T05:40:05.989755+0000
  Expiry: expires in 14h 38m 2s 951316us
System ID: 1921.6800.1001
Dynamic Hostname TLV (137): isr1
Protocols Supported TLVs (129):
  Network layer protocol ID: IPv6
  Network layer protocol ID: IPv4
Area Address TLVs (1):
  Area address: 49.0001
IS Reachability TLVs (22):
  IS neighbor: 1921.6800.1006.00      Metric: 1000000,
  IS neighbor: 1921.6800.1006.01      Metric: 1000000,
IPv4 Reachability TLVs (135):
  IPv4 prefix: 16.0.1.0/24             Metric: 1000000   Internal   Up
  IPv4 prefix: 16.0.2.0/24             Metric: 1000000   Internal   Up
  IPv4 prefix: 192.168.1.1/32          Metric: 1000000   Internal   Up
SID: 100  Flags: Node
IPv6 Reachability TLVs (236):
  IPv6 prefix: 16:0:1::/64             Metric: 1000000   Internal   Up
  IPv6 prefix: 16:0:2::/64             Metric: 1000000   Internal   Up
  IPv6 prefix: 192:168:1::1/128        Metric: 1000000   Internal   Up
SID: 102  Flags: Node
Segment Routing TLVs (242/sub 2):
  SRGB: Base: 1000, Range: 1000, Router ID: 192.168.1.1
LSP ID: isr6.00-00
Interface: if1-0/0/2/1
LSP Header:
  Sequence: 0x3
  Checksum: 0xe281
  Remaining lifetime: 52682 seconds
  Flags: Attached: 0, Overload: 0
Packet:
  Length: 182 bytes
  Last received time: 2024-07-25T05:40:05.786957+0000
  Expiry: expires in 14h 38m 2s 748444us
System ID: 1921.6800.1006
Dynamic Hostname TLV (137): isr6
Protocols Supported TLVs (129):
  Network layer protocol ID: IPv6
  Network layer protocol ID: IPv4
Area Address TLVs (1):
  Area address: 49.0001
IS Reachability TLVs (22):
  IS neighbor: 1921.6800.1001.00      Metric: 1000000,
  IS neighbor: 1921.6800.1006.01      Metric: 1000000,
IPv4 Reachability TLVs (135):
  IPv4 prefix: 16.0.1.0/24             Metric: 1000000   Internal   Up
  IPv4 prefix: 16.0.2.0/24             Metric: 1000000   Internal   Up
  IPv4 prefix: 192.168.1.6/32          Metric: 1000000   Internal   Up
SID: 600  Flags: Node
IPv6 Reachability TLVs (236):
  IPv6 prefix: 16:0:1::/64             Metric: 1000000   Internal   Up
  IPv6 prefix: 16:0:2::/64             Metric: 1000000   Internal   Up
  IPv6 prefix: 192:168:1::6/128        Metric: 1000000   Internal   Up
SID: 601  Flags: Node
Segment Routing TLVs (242/sub 2):

```

```
SRGB: Base: 6000, Range: 1000, Router ID: 192.168.1.6
<...>
```

### Example 4: Summary view of the IS-IS database for the specified instance

```
supervisor@rtbrick>spinel: op> show isis database instance default
Instance: default, Level: 1
  LSP ID           Sequence    Checksum    Lifetime    Overload    Attached
  isr1.00-00       0x4        0xe035     52625      0           0
  isr6.00-00       0x3        0xe281     52625      0           0
  isr6.01-00       0x1        0x4b1a     52618      0           0
Instance: default, Level: 2
  LSP ID           Sequence    Checksum    Lifetime    Overload    Attached
  isr1.00-00       0x6        0x75af     52625      0           0
  isr6.00-00       0x5        0x117e     52625      0           0
  isr6.01-00       0x1        0x4b1a     52618      0           0
```

### Example 5: Summary view of the IS-IS database for the specified instance and LSP

```
supervisor@rtbrick>spinel: op> show isis database instance default lsp
1921.6800.1001.00-00
Instance: default, Level: 1
  LSP ID: isr1.00-00
  Interface:
  LSP Header:
    Sequence: 0x4
    Checksum: 0xe035
    Remaining lifetime: 65535 seconds
    Flags: Attached: 0, Overload: 0
  Packet:
    Length: 182 bytes
    Last received time: 2024-07-25T05:40:05.989755+0000
    Expiry: expires in 14h 36m 35s 357028us
  System ID: 1921.6800.1001
  Dynamic Hostname TLV (137): isr1
  Protocols Supported TLVs (129):
    Network layer protocol ID: IPv6
    Network layer protocol ID: IPv4
  Area Address TLVs (1):
    Area address: 49.0001
  IS Reachability TLVs (22):
    IS neighbor: 1921.6800.1006.00      Metric: 1000000
    IS neighbor: 1921.6800.1006.01      Metric: 1000000
  IPv4 Reachability TLVs (135):
    IPv4 prefix: 16.0.1.0/24           Metric: 1000000   Internal   Up
    IPv4 prefix: 16.0.2.0/24           Metric: 1000000   Internal   Up
    IPv4 prefix: 192.168.1.1/32        Metric: 1000000   Internal   Up
  SID: 100  Flags: Node
  IPv6 Reachability TLVs (236):
    IPv6 prefix: 16:0:1::/64           Metric: 1000000   Internal   Up
    IPv6 prefix: 16:0:2::/64           Metric: 1000000   Internal   Up
    IPv6 prefix: 192:168:1::1/128      Metric: 1000000   Internal   Up
  SID: 102  Flags: Node
  Segment Routing TLVs (242/sub 2):
    SRGB: Base: 1000, Range: 1000, Router ID: 192.168.1.1
  <...>
```

## IS-IS Route

### Syntax:

**show isis route** <option>

Option	Description
-	Without any option, this command displays a summary of the IS-IS route information
instance	Displays IS-IS route information for an instance
<afi> <safi>	Routing information for the specified AFI/SAFI. Supported SAFI values are 'unicast' and 'labeled-unicast'.

### Example 1: Summary view of the IS-IS routes

```

supervisor@rtbrick>spinel: op> show isis route
Instance: default, AFI: ipv4, SAFI: unicast
  Prefix          Level  Metric   Type      Next Hop      Interface
  16.0.1.0/24      1      1000000  Internal  n/a           local
  16.0.2.0/24      1      1000000  Internal  n/a           local
  192.168.1.1/32   1      1000000  Internal  n/a           local
  192.168.1.6/32   1      2000000  Internal  16.0.2.6     ifl-0/0/2/1
                                       16.0.1.6     ifl-0/0/2/0

Instance: default, AFI: ipv4, SAFI: labeled-unicast
  Prefix          Level  Metric   SID Index  Next Hop      Interface  Label
  192.168.1.6/32   1      2000000  600        16.0.2.6     ifl-0/0/2/1
                                       16.0.1.6     ifl-0/0/2/0

Instance: default, AFI: ipv6, SAFI: unicast
  Prefix          Level  Metric   Type      Next Hop      Interface
  16:0:1::/64     1      1000000  Internal  n/a           local
  16:0:2::/64     1      1000000  Internal  n/a           local
  192:168:1::1/128 1      1000000  Internal  n/a           local
  192:168:1::6/128 1      2000000  Internal  fe80::7847:eff:fec0:0 ifl-0/0/2/0

<...>
    
```

### Example 2: Summary view of the IS-IS routes for the specified instance

```

supervisor@rtbrick>spinel: op> show isis route instance default
Instance: default, AFI: ipv4, SAFI: unicast
  Prefix          Level  Metric   Type      Next Hop      Interface
  16.0.1.0/24      1      1000000  Internal  n/a           local
  16.0.2.0/24      1      1000000  Internal  n/a           local
  192.168.1.1/32   1      1000000  Internal  n/a           local
  192.168.1.6/32   1      2000000  Internal  16.0.2.6     ifl-0/0/2/1
                                       16.0.1.6     ifl-0/0/2/0

Instance: default, AFI: ipv4, SAFI: labeled-unicast
  Prefix          Level  Metric   SID Index  Next Hop      Interface  Label
  192.168.1.6/32   1      2000000  600        16.0.2.6     ifl-0/0/2/1
                                       16.0.1.6     ifl-0/0/2/0

Instance: default, AFI: ipv6, SAFI: unicast
  Prefix          Level  Metric   Type      Next Hop      Interface
    
```

```

16:0:1::/64          1  1000000  Internal  n/a          local
16:0:2::/64          1  1000000  Internal  n/a          local
192:168:1::1/128    1  1000000  Internal  n/a          local
192:168:1::6/128    1  2000000  Internal  fe80::7847:eff:fec0:0 ifl-0/0/2/0
                                     fe80::7847:e00:1c0:0  ifl-0/0/2/1
<...>
    
```

Example 3: Summary view of the IS-IS routes for the specified instance and address family (IPv4 unicast).

```

supervisor@rtbrick>spinel: op> show isis route instance default ipv4 unicast
Instance: default, AFI: ipv4, SAFI: unicast
Prefix          Level  Metric  Type      Next Hop  Interface
16.0.1.0/24     1      1000000 Internal  n/a       local
16.0.2.0/24     1      1000000 Internal  n/a       local
192.168.1.1/32  1      1000000 Internal  n/a       local
192.168.1.6/32  1      2000000 Internal  16.0.2.6  ifl-0/0/2/1
                                     16.0.1.6  ifl-0/0/2/0
    
```

Example 4: Summary view of the IS-IS routes for the specified instance and address family (IPv4 labeled-unicast).

```

supervisor@rtbrick>spinel: op> show isis route instance default ipv4 labeled-unicast
Instance: default, AFI: ipv4, SAFI: labeled-unicast
Prefix          Level  Metric  SID Index  Next Hop  Interface  Label
192.168.1.6/32  1      2000000  600        16.0.2.6  ifl-0/0/2/1
                                     16.0.1.6  ifl-0/0/2/0
    
```

Example 5: Summary view of the IS-IS routes for the specified instance and address family (IPv6 unicast).

```

supervisor@rtbrick>spinel: op> show isis route instance default ipv6 unicast
Instance: default, AFI: ipv6, SAFI: unicast
Prefix          Level  Metric  Type      Next Hop
Interface
16:0:1::/64     1      1000000  Internal  n/a          local
16:0:2::/64     1      1000000  Internal  n/a          local
192:168:1::1/128 1      1000000  Internal  n/a          local
192:168:1::6/128 1      2000000  Internal  fe80::7847:eff:fec0:0 ifl-
0/0/2/0
                                     fe80::7847:e00:1c0:0  ifl-
0/0/2/1
    
```

## IS-IS Segment Routing

### Syntax:

**show isis segment-routing** <option>

Option	Description
global-block	Displays Segment routing global block (SRGB) information
global-block instance <instance>	Displays Segment routing global block (SRGB) information for the specified instance
label-binding	Displays the IS-IS segment routing label bindings information
label-binding instance <instance>	Displays the IS-IS segment routing label bindings for the specified instance
prefix-segment	Displays the IS-IS prefix segments information
prefix-segment <instance>	Displays the IS-IS prefix segments for the specified instance
adjacency-segment	Displays the IS-IS segment routing adjacency SIDs

### Example 1: Summary view of the IS-IS segment routing global block

```

supervisor@rtbrick>spine1: op> show isis segment-routing global-block
Instance: default, Level: 1
  System          SRGB Base   SRGB Range
  isr1            1000       1000
  isr6            6000       1000
Instance: default, Level: 2
  System          SRGB Base   SRGB Range
  isr1            1000       1000
  isr6            6000       1000
    
```

### Example 2: Summary view of the IS-IS segment routing label binding

```

supervisor@rtbrick>spine1: op> show isis segment-routing label-binding
Instance: default, Level: 1
  System      Prefix          Range   SID   Flags
Instance: default, Level: 2
  System      refix          Range   SID   Flags
    
```

### Example 3: Summary view of the IS-IS segment routing prefix segment

```

supervisor@rtbrick>spine1: op> show isis segment-routing prefix-segment
Instance: default, Level: 1
  System      Prefix          SID     Flags
  isr1       192.168.1.1/32  100    Node
  isr1       192:168:1::1/128 102    Node
  isr6       192.168.1.6/32  600    Node
  isr6       192:168:1::6/128 601    Node
    
```

```
Instance: default, Level: 2
  System      Prefix      SID      Flags
  isr1        192.168.1.1/32    100     Node
  isr1        192.168.1.6/32    600     Re-advertisement,
Node
  isr1        192:168:1::1/128  102     Node
  isr1        192:168:1::6/128  601     Re-advertisement,
Node
  isr6        192.168.1.1/32    100     Re-advertisement,
Node
  isr6        192.168.1.6/32    600     Node
  isr6        192:168:1::1/128  102     Re-advertisement,
Node
  isr6        192:168:1::6/128  601     Node
```

Example 4: Summary view of the IS-IS segment routing adjacency-segment

```
supervisor@S1-STD-17-1703: cfg> show isis segment-routing adjacency-segment
Instance: default, Level: 1, No adjacency-segments
Instance: default, Level: 2, No adjacency-segments
```

**IS-IS SPF**

**Syntax:**

**show isis spf** <option>

Option	Description
result	Displays a summary of the IS-IS SPF results
result <instance>	Displays a summary of the IS-IS SPF results for the specified instance
result [level-1/level2]	Displays a summary of the IS-IS SPF results for the specified level.

Example 1: Summary view of the IS-IS SPF result

```
supervisor@rtbrick>spinel: op> show isis spf result
Instance: default, Level: 1
  Destination Node      Metric      Neighbor Node      Interface      Nexthop      Address
  1921.6800.1001.00      0           1921.6800.1006.00  if1-0/0/2/0   IPv6          fe80::7847:eff:fec0:0
  1921.6800.1006.00      1000000    1921.6800.1006.00  if1-0/0/2/1   IPv6          fe80::7847:e00:1c0:0
  1921.6800.1006.00      1000000    1921.6800.1006.00  if1-0/0/2/0   IPv4          16.0.1.6
  1921.6800.1006.00      1000000    1921.6800.1006.00  if1-0/0/2/1   IPv4          16.0.2.6
  1921.6800.1006.01      1000000    local
Instance: default, Level: 2
  Destination Node      Metric      Neighbor Node      Interface      Nexthop      Address
  1921.6800.1001.00      0           1921.6800.1006.00  local
  1921.6800.1006.00      1000000    1921.6800.1006.00  if1-0/0/2/0   IPv6          fe80::7847:eff:fec0:0
  1921.6800.1006.00      1000000    1921.6800.1006.00  if1-0/0/2/1   IPv6          fe80::7847:e00:1c0:0
  1921.6800.1006.00      1000000    1921.6800.1006.00  if1-0/0/2/0   IPv4          16.0.1.6
```



1921.6800.1006.01	1000000	1921.6800.1006.00	ifl-0/0/2/1	IPv4	16.0.2.6
			local		

### Example 2: Summary view of the IS-IS SPF result for level-1

```

supervisor@rtbrick>spinel: op> show isis spf result level-1
Instance: default, Level: 1
  Destination Node      Metric      Neighbor Node      Interface      Nexthop      Address
  1921.6800.1001.00    0           1921.6800.1006.00  local
  1921.6800.1006.00    1000000    1921.6800.1006.00  ifl-0/0/2/0   IPv6         fe80::7847:eff:fec0:0
  1921.6800.1006.00    1000000    1921.6800.1006.00  ifl-0/0/2/1   IPv6         fe80::7847:e00:1c0:0
  1921.6800.1006.00    1000000    1921.6800.1006.00  ifl-0/0/2/0   IPv4         16.0.1.6
  1921.6800.1006.00    1000000    1921.6800.1006.00  ifl-0/0/2/1   IPv4         16.0.2.6
  1921.6800.1006.01    1000000    1921.6800.1006.00  ifl-0/0/2/1   IPv4         16.0.2.6
  1921.6800.1006.01    1000000    1921.6800.1006.00  local
    
```

### Example 3: Summary view of the IS-IS SPF result for level-2

```

supervisor@rtbrick>spinel: op> show isis spf result level-2
Instance: default, Level: 2
  Destination Node      Metric      Neighbor Node      Interface      Nexthop      Address
  1921.6800.1001.00    0           1921.6800.1006.00  local
  1921.6800.1006.00    1000000    1921.6800.1006.00  ifl-0/0/2/0   IPv6
  fe80::7847:eff:fec0:0
  1921.6800.1006.00    1000000    1921.6800.1006.00  ifl-0/0/2/1   IPv6
  fe80::7847:e00:1c0:0
  1921.6800.1006.00    1000000    1921.6800.1006.00  ifl-0/0/2/0   IPv4         16.0.1.6
  1921.6800.1006.00    1000000    1921.6800.1006.00  ifl-0/0/2/1   IPv4         16.0.2.6
  1921.6800.1006.01    1000000    1921.6800.1006.00  local
    
```

### Example 4: Summary view of the IS-IS SPF result of a specific instance for level-1

```

supervisor@rtbrick>spinel: op> show isis spf result instance default level-1
Instance: default, Level: 1
  Destination Node      Metric      Neighbor Node      Interface      Nexthop      Address
  1921.6800.1001.00    0           1921.6800.1006.00  local
  1921.6800.1006.00    1000000    1921.6800.1006.00  ifl-0/0/2/0   IPv6
  fe80::7847:eff:fec0:0
  1921.6800.1006.00    1000000    1921.6800.1006.00  ifl-0/0/2/1   IPv6
  fe80::7847:e00:1c0:0
  1921.6800.1006.00    1000000    1921.6800.1006.00  ifl-0/0/2/0   IPv4         16.0.1.6
  1921.6800.1006.00    1000000    1921.6800.1006.00  ifl-0/0/2/1   IPv4         16.0.2.6
  1921.6800.1006.01    1000000    1921.6800.1006.00  local
    
```

### Example 5: Summary view of the IS-IS SPF result of a specific instance for level-2

```

supervisor@rtbrick>spinel: op> show isis spf result instance default level-2
Instance: default, Level: 2
  Destination Node      Metric      Neighbor Node      Interface      Nexthop      Address
  1921.6800.1001.00    0           1921.6800.1006.00  local
  1921.6800.1006.00    1000000    1921.6800.1006.00  ifl-0/0/2/0   IPv6
  fe80::7847:eff:fec0:0
  1921.6800.1006.00    1000000    1921.6800.1006.00  ifl-0/0/2/1   IPv6
  fe80::7847:e00:1c0:0
  1921.6800.1006.00    1000000    1921.6800.1006.00  ifl-0/0/2/0   IPv4         16.0.1.6
  1921.6800.1006.00    1000000    1921.6800.1006.00  ifl-0/0/2/1   IPv4         16.0.2.6
  1921.6800.1006.01    1000000    1921.6800.1006.00  local
    
```

## IS-IS Clear Commands

Clear commands allow to reset operational states.

### IS-IS Interface

#### Syntax:

**clear isis interface** <option> ...

Option	Description
statistics	Clears the statistics of all IS-IS interfaces.

Example: The example below shows how to clear IS-IS interface statistics.

```
supervisor@rtbrick>spine1: op> clear isis interface statistics
```

### IS-IS Neighbor

#### Syntax:

**clear isis neighbor** <option> ...

Option	Description
neighbor	Clears neighbors of the default instance
neighbor instance <instance_name>	Clears neighbors of the specified instance
neighbor instance <instance_name> interface <interface- name>	Clears the specified interface of a specified neighbor instance

Example: The example below shows how to clear neighbors of the specified instance

```
supervisor@rtbrick>spine1: op> clear isis neighbor instance default
```

## IS-IS Database

### Syntax:

**clear isis database** <option> ...

Option	Description
Instance	Clears neighbors of the default instance
level-1	Clears area level-1
level-2	Clears area level-2
lsp	Clears IS-IS database for the specific LSP ID
System	Clears the LSDB system ID

Example: The example below shows how to clear the database instance

```
supervisor@rtbrick>spinel: op> clear isis database instance default
```

The LSDB data is cleared for instance default

## 2.7. OSPFv2/v3

### 2.7.1. OSPF Overview

OSPF (Open Shortest Path First) is an Interior Gateway Protocol that distributes routing information within a single Autonomous System (AS) in an IP network. OSPF is a link-state routing protocol that uses link-state information to form a routing table and exchange the routing information with the neighbors.

RtBrick FullStack (RBFS) supports OSPF version 2 (OSPFv2) and OSPF version 3 (OSPFv3), including authentication, LDP-IGP sync, and redistribution policy. RBFS does not support OSPFv3 Virtual Link.

OSPF routers flood LSAs (link-state advertisements) to all other routers in an autonomous system. Routers generate routing tables using the information received from the LSAs and calculate the best path to other routers in the network. OSPF uses the Dijkstra (Shortest Path First) algorithm to calculate the best path.

LSAs contain local state information such as interfaces and the reachability of

neighbors. Other routers, which receive this information as LSAs, build their LSDB (link-state database) using this information. In an OSPF network, all routers build and maintain information about the topology of that network.

## OSPFv3

OSPF Version 3 (OSPFv3) is a modified version of OSPF and it provides support for the OSPF routing protocol within an IPv6 network. As such, it provides support for IPv6 addresses and prefixes. It retains most of the structure and functions in OSPFv2 (for IPv4) with a few changes.

OSPFv3 differs from OSPFv2 in the following ways:

- OSPFv3 runs on IPv6, which is based on links rather than network segments
- OSPFv3 does not depend on IP addresses
- OSPFv3 packets and the LSA format have the following changes:
  - OSPFv3 router LSAs and network LSAs do not contain IP addresses, which are advertised by Type 8 LSAs and Type 9 LSAs
- In OSPFv3, information about the flooding scope is added in the LSA Type field
  - OSPFv3 stores or floods unidentified packets, whereas OSPFv2 discards
- OSPFv3 supports multi-process on a link with instance ID
- OSPFv3 uses IPv6 link-local addresses for forwarding

### OSPFv3 Instance ID

One of the advancements of OSPFv3 over OSPFv2 is the use of the instance ID. This instance ID is an 8-bit field within the OSPFv3 header.

The original intent for the instance ID was to support multiple instances of OSPFv3 to run on the same interface. In this way, you can manipulate which routers on a particular segment are allowed to form adjacencies. You could use an instance number of 0 through 255 to distinguish between the different OSPFv3 instances.

However, within RFC 5838, the instance ID was re-purposed to be used to support address families (AFs) with OSPFv3. The default instance of 0 is used if no other instance is defined. However, specific ranges of the instance ID map to specific AFs. According to the RFC, these ranges are:

- Instance ID 0 to 31 — IPv6 unicast AF
- Instance ID 32 to 63 — IPv6 multicast AF
- Instance ID 64 to 95 — IPv4 unicast AF
- Instance ID 96 to 127 — IPv4 multicast AF
- Instance ID 128 to 255 — Unassigned

When using IPv4 unicast or IPv6 unicast, the allowed values for the command are between 0 and 31.



RBFS only supports IPv6 unicast addresses ranging from 0 to 31.

## Understanding OSPF Areas

OSPF allows for a logical partition of the autonomous system by dividing it into areas. This logical partitioning helps to limit the flooding of link-state updates within an area.

An OSPF Autonomous System can be maintained as a single-area network or can be divided as a multi-area network. In a single area AS, the topology provides link-state information of routers in the entire autonomous system.

In a multi-area AS, the topology provides the link-state information of routers belonging to that particular area, not about routers in other areas in the autonomous system. Within an area, all OSPF routers maintain separate databases which are identical.

In a multi-area OSPF network, all areas are connected to the backbone area, known as Area 0.

### Backbone Area

The backbone area, also known as Area 0, is connected to all other areas in an OSPF network. The backbone area, which acts as a central point of communication, receives LSAs from other areas and disseminates the same to other areas.

### Area Border Router

Routers that connect one or more areas with the backbone area are called Area Border Router (ABR). One interface of the ABR is connected to the backbone, while other interfaces are connected to other areas. ABRs, which belong to multiple

areas in an OSPF network, maintain separate LSDBs for each area that they are connected to.

The following OSPF architectural diagram shows a simple OSPF network that is divided into areas. Area 1 and Area 2 are connected to the backbone area (Area 0) through the ABRs. Area 1 and Area 2 are not directly connected. They receive link state advertisements from each other from Area 0 which acts as the central point of communication for all other areas.

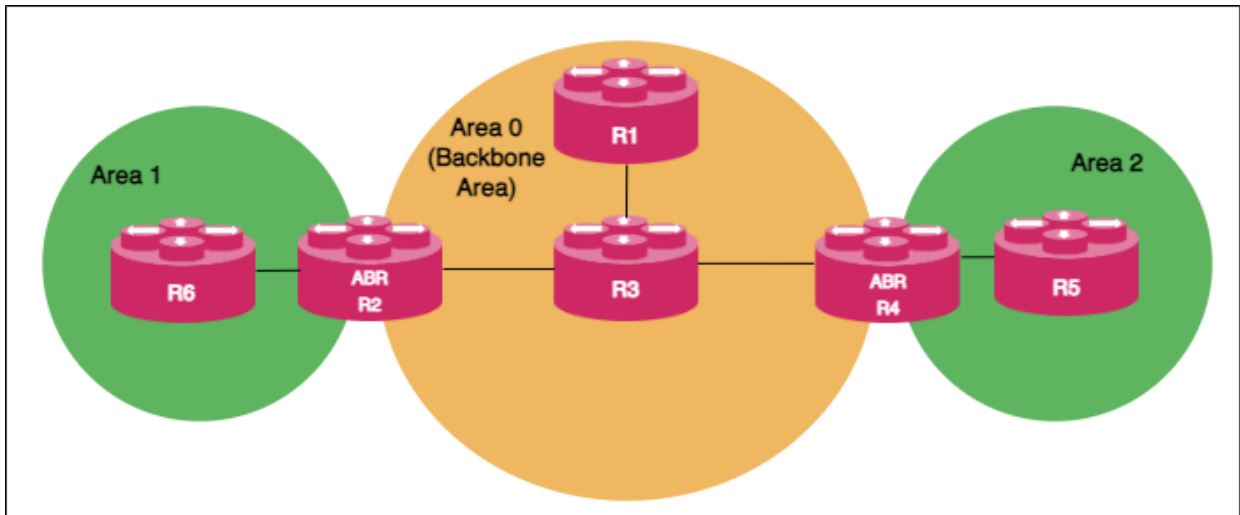

### Autonomous System Boundary Router

ASBR (Autonomous System Boundary Router) serves as a gateway router to the OSPF autonomous system. ASBR can operate multiple protocols and work with other autonomous system routers that run other interior gateway protocols such as EIGRP, IS-IS, i-BGP, and so on. ASBR can import and translate different protocol routes into OSPF through the redistribution mechanism.

### OSPF DR and BDR Election

An OSPF network chooses one router as a Designated Router (DR) and another as a Backup Designated Router (BDR) for a broadcast network.

DR acts as a central point of communication by receiving and distributing topology information. BDR takes over the role of DR if the DR fails. Routers in an OSPF network do not directly exchange routing information with each other. Instead, every router in the network updates routing information only with DR and BDR. DR, in turn, distributes the topology information with all other routers. This mechanism reduces network traffic significantly. OSPF chooses one router as DR and another router as BDR based on the following criteria:

- The router with the highest priority value becomes the designated router and the router with the second highest priority value becomes the BDR. You can define the priority values for routers during the interface configuration.
- If multiple routers have the same highest priority value, then the router with the highest router ID is elected as DR and the router with the second highest router ID value becomes the BDR.

You can choose a priority value from the range 0 - 255. Routers with the priority value '0' do not participate in the DR or BDR election.

## Supported OSPF Standards

RBFS supports the following RFCs, which define standards for OSPFv2 and OSPFv3.

- RFC 2328, OSPF Version 2
- RFC 5340, OSPF for IPv6
- RFC 5709, OSPFv2 HMAC-SHA Cryptographic Authentication
- RFC 7166, Supporting Authentication Trailer for OSPFv3
- RFC 8665, OSPF Extensions for Segment Routing
- RFC 8666, OSPFv3 Extensions for Segment Routing



RF and draft compliance are partial except as specified.

## Supported Platforms

Not all features are necessarily supported on each hardware platform. Refer to the *Platform Guide* for the features and the sub-features that are or are not supported by each platform.

## 2.7.2. OSPF Configuration

### Configuration Hierarchy

The diagram illustrates the OSPF configuration hierarchy. All OSPF configuration is performed within an instance, for example, the default instance or a VPN service instance. The OSPF instance configuration hierarchy includes parameters that are generic to the respective OSPF instance. The sub-hierarchies include parameters that are specific to redistribution or authentication.

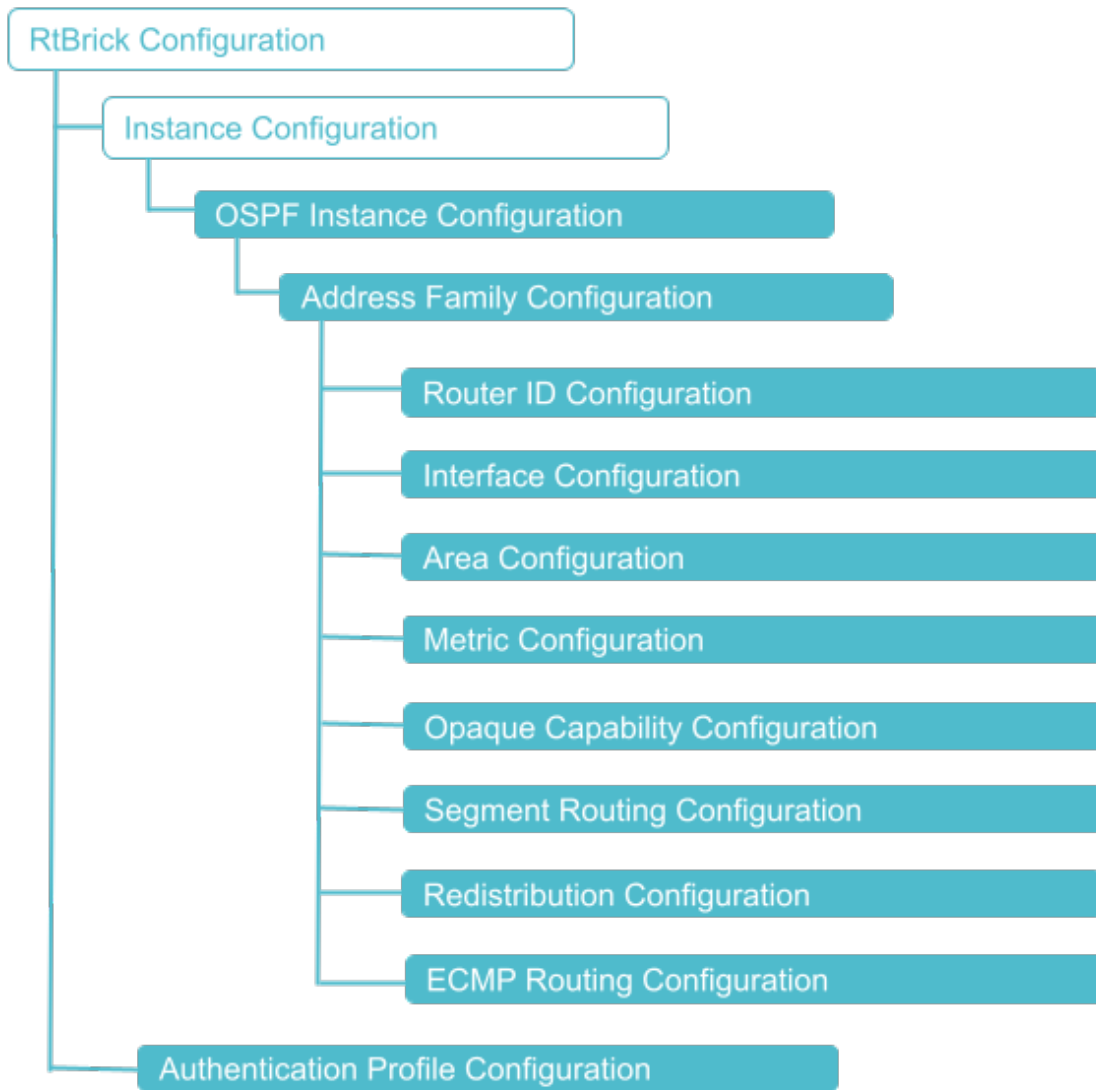

## Configuration Syntax and Commands

The following sections describe the OSPF configuration syntax and commands.

### OSPF Instance Configuration

At this configuration hierarchy, you can configure an OSPF instance.

Syntax:

**set instance** <instance-name> **protocol ospf**

Attribute	Description
<instance-name>	Name of the OSPF instance.



## OSPF Address Family Configuration

At this configuration level, you configure the OSPF protocol address family.



You must configure the OSPF address family on an OSPF instance before configuring other supported OSPF features.

### Syntax

**set instance** <instance-name> **protocol ospf address-family** <afi>

Attribute	Description
<instance-name>	Name of the instance
<afi>	Specifies the Address family identifier (AFI), either IPv4 or IPv6.

The following example shows the OSPF address family (IPv4) configuration.

#### Example 1: OSPF Instance Address Family IPv6 Configuration

```

supervisor@rtbrick>SPINE01: cfg> show config instance default protocol ospf address-family ipv4
{
  "rtbrick-config:ipv4": {
    "router-id": "198.51.100.10",
    "area": [
      {
        "area-id": "0.0.0.0",
        "interface": [
          {
            "name": "if1-0/0/0/1",
            "network-type": "p2p"
          },
          {
            "name": "lo-0/0/0/1"
          }
        ]
      }
    ]
  }
}
<...>

```

The following example shows the OSPF address family (IPv6) configuration.

#### Example 2: OSPF Instance Address Family IPv6 Configuration

```

supervisor@rtbrick>SPINE01: cfg> show config instance default protocol ospf address-family ipv6
{
  "rtbrick-config:ipv6": {
    "instance-id": [

```

```

{
  "instance-id": 0,
  "router-id": "192.168.0.10",
  "metric": 1000,
  "segment-routing": {
    "status": "enable",
    "srgb": {
      "base": 1000,
      "range": 1000
    }
  },
  "redistribute": [
    {
      "source": "bgp",
      "metric": 2000
    },
    {
      "source": "direct",
      "policy": "ospf_policy_1"
    }
  ],
  "area": [
    {
      "area-id": "0.0.0.0",
      "metric": 1000,
      "interface": [
        {
          "name": "ifl-0/0/0/1",
          "authentication-profile": "AUTH_PROFILE_SHA_512_1"
        },
        {
          "name": "ifl-0/0/0/100",
          "metric": 20000,
          "network-type": "p2p",
          "authentication-profile": "AUTH_PROFILE_SHA_512_1"
        },
        {
          "name": "ifl-0/0/1/1",
          "metric": 40000,
          "network-type": "p2p",
          "authentication-profile": "AUTH_PROFILE_SHA_512_1"
        },
        {
          "name": "ifl-0/0/1/100",
          "metric": 30000,
          "authentication-profile": "AUTH_PROFILE_SHA_512_1"
        }
      ]
    }
  ]
}
<...>

```

## OSPF Router ID Configuration

The router ID is an IP address that OSPF uses to identify a device on the network. The router ID should be configured under the address family hierarchy.

### Syntax

```

set instance <instance-name> protocol ospf address-family <afi> <attribute>
<value>

```

Attribute	Description
<afi>	Specifies the Address family identifier (AFI), either IPv4 or IPv6.
<afi> instance-id <instance-id>	Specifies the instance ID. When using an IPv6 address family with OSPFv3, an instance ID ranging from 0 to 31 must be specified.
router-id <ipv4-address>	The router ID of the routing instance. It is recommended to specify the router ID.

### Example 1: OSPF IPv4 Router Identifier Configuration

```
supervisor@rtbrick>SPINE01: cfg> show config instance default protocol ospf
address-family ipv4 router-id
{
  "rtbrick-config:router-id": "192.168.0.10"
}
supervisor@rtbrick>SPINE01: cfg>
```

### Example 2: OSPF IPv6 Router Identifier Configuration

```
supervisor@rtbrick>SPINE01: cfg> show config instance default protocol ospf
address-family ipv6 instance-id 0 router-id
{
  "rtbrick-config:router-id": "192.168.0.10"
}
supervisor@rtbrick>SPINE01: cfg>
```

## OSPF Hostname Configuration

Identifying routers through Open Shortest Path First (OSPF) hostnames can simplify network management as they are easier to remember than router IDs.

### Syntax

**set instance** <instance-name> **protocol ospf address-family** <afi> <attribute> <value>

Attribute	Description
<afi>	Specifies the Address family identifier (AFI), either IPv4 or IPv6.

Attribute	Description
<afi> instance-id <instance-id>	Specifies the instance ID. When using an IPv6 address family with OSPFv3, an instance ID ranging from 0 to 31 must be specified.
hostname <hostname>	The hostname of the routing instance.

### Example 1: OSPF IPv4 Router Identifier Configuration

```

supervisor@rtbrick>SPINE01: cfg> show config instance default protocol ospf
address-family ipv4 hostname
{
  "rtbrick-config:hostname": "C-BNG"
}
supervisor@rtbrick>SPINE01: cfg>
    
```

### Example 2: OSPF IPv6 Router Identifier Configuration

```

supervisor@rtbrick>SPINE01: cfg> show config instance default protocol ospf
address-family ipv6 instance-id 0 hostname
{
  "rtbrick-config:hostname": "C-BNG"
}
supervisor@rtbrick>SPINE01: cfg>
    
```

## OSPF Area Configuration

A particular area is defined by its area ID.

**set instance** <instance-name> **protocol ospf address-family** <afi> <attribute> <value>

Attribute	Description
<afi>	Specifies the Address family identifier (AFI), either IPv4 or IPv6.
<afi> instance-id <instance-id>	Specifies the instance ID. When using an IPv6 address family with OSPFv3, an instance ID ranging from 0 to 31 must be specified.
area <area-id>	Specifies the OSPF area ID.
area <area-id> metric	Area scope metric. Range: 1 - 65535. Default: 10000.

Attribute	Description
area <area-id> area-type stub	A stub area is an area through which or into which AS external advertisements are not flooded instead type-3 LSA advertise with a default route.
area <area-id> area-type totally-stub	Totally stub area is an area in which type-3 LSAs are not allowed instead type-3 LSAs advertise with a default route.
area <area-id> authentication-profile <authentication-profile>	Specifies the authentication profile name used to create an attachment point at the area level.
area <area-id> no-authentication-check <enable>	When enabled, OSPF packets received here will not undergo authentication validation, even if the user has enabled authentication. However, OSPF will continue to send authenticated packets from this interface.

### Example 1: OSPF IPv4 Area Configuration

```

supervisor@rtbrick>SPINE01: cfg> show config instance default protocol ospf address-family ipv4 area 0.0.0.0
{
  "rtbrick-config:area": [
    {
      "area-id": "0.0.0.0",
      "interface": [
        {
          "name": "if1-0/0/0/1",
          "authentication-profile": "AUTH_PROFILE_SHA_512_1"
        },
        {
          "name": "if1-0/0/0/100",
          "metric": 20000,
          "network-type": "p2p",
          "authentication-profile": "AUTH_PROFILE_SHA_512_1"
        },
        {
          "name": "if1-0/0/1/1",
          "metric": 40000,
          "network-type": "p2p",
          "authentication-profile": "AUTH_PROFILE_SHA_512_1"
        },
        {
          "name": "if1-0/0/1/100",
          "metric": 30000,
          "authentication-profile": "AUTH_PROFILE_SHA_512_1"
        },
        {
          "name": "if1-0/0/4/1",
          "metric": 60000
        },
        {
          "name": "lo-0/0/0/1"
        },
        {
          "name": "lo-0/0/0/2"
        }
      ]
    }
  ]
}

```

```

    }
  ]
}

```

## Example 2: OSPF IPv6 Area Configuration

```

supervisor@rtbrick>SPINE01: cfg> show config instance default protocol ospf address-family ipv6 instance-id 0
area 0.0.0.0
{
  "rtbrick-config:area": [
    {
      "area-id": "0.0.0.0",
      "interface": [
        {
          "name": "ifl-0/0/0/1",
          "authentication-profile": "AUTH_PROFILE_SHA_512_1"
        },
        {
          "name": "ifl-0/0/0/100",
          "metric": 20000,
          "network-type": "p2p",
          "authentication-profile": "AUTH_PROFILE_SHA_512_1"
        },
        {
          "name": "ifl-0/0/1/1",
          "metric": 40000,
          "network-type": "p2p",
          "authentication-profile": "AUTH_PROFILE_SHA_512_1"
        },
        {
          "name": "ifl-0/0/1/100",
          "metric": 30000,
          "authentication-profile": "AUTH_PROFILE_SHA_512_1"
        },
        {
          "name": "ifl-0/0/4/1",
          "metric": 60000
        },
        {
          "name": "lo-0/0/0/1"
        },
        {
          "name": "lo-0/0/0/2"
        }
      ]
    }
  ]
}

```

## OSPF Interface Configuration

Enable OSPF protocol on the router interfaces.

Syntax:

**set instance** <instance-name> **protocol ospf address-family** <afi> <attribute>  
<value>

Attribute	Description
<afi>	Specifies the Address family identifier (AFI), either IPv4 or IPv6.
<afi> instance-id <instance-id>	Specifies the instance ID. When using an IPv6 address family with OSPFv3, an instance ID ranging from 0 to 31 must be specified.
area <area-id> interface <interface-name> ldp- synchronization enable	Enables LDP OSPF Synchronization. By default, LDP OSPF synchronization is disabled.
metric <metric>	Specify the metric value of an OSPF interface.
network-type <broadcast   p2p>	broadcast - Sets the network type to broadcast; p2p - Sets the network type to point-to-point. By default, the network-type is <b>broadcast</b> .
router-priority <router- priority>	Sets the router priority for an interface. Allowed range: 0 - 255, Default: 1. Routers with priority value '0' do not participate in the DR or BDR election.
segment-routing index	Sets the prefix segment identifier (SID) index for the specified interface.
timer <hello   dead   wait>	<p>Interface timer for configuring <b>hello</b>, <b>dead</b>, and <b>wait</b> timers.</p> <ul style="list-style-type: none"> <li>• <b>hello</b>: Sets interval time for sending hello packets to a neighbor and this time is identical on OSPF neighbor routers. Default: 10 seconds.</li> <li>• <b>dead</b>: Sets interval time within which if the interface does not receive any hello packet from its neighbor, the interface comes to know that the neighbor is down. Default: 40 seconds.</li> <li>• <b>wait</b>: Sets wait time to delay to trigger the DR/BDR election. It cannot be more than the time set for the dead interval. Default: 40 seconds.</li> </ul>

Attribute	Description
mtu-ignore enable	If there is an MTU mismatch on both sides of the link where OSPF runs, the OSPF adjacency will not come up as the MTU value carried in the Database Description (DBD) packets. To avoid MTU validation in the Database Description (DBD) packets, configure <b>mtu-ignore</b> command. By default, it is disabled.
authentication <authentication-profile>	Specifies the authentication profile name used to create an attachment point at the interface level.
no-authentication-check <enable>	When enabled, OSPF packets received here will not undergo authentication validation at the interface level, even if the user has enabled authentication.



If an authentication profile is attached to an interface and an area, the authentication profile attached to the interface takes priority.

### Example 1: OSPF IPv4 Interface Configuration

```

supervisor@rtbrick>SPINE01: cfg> show config instance default protocol ospf address-family ipv4 area 0.0.0.0
interface
{
  "rtbrick-config:interface": [
    {
      "name": "if1-0/0/0/1",
      "authentication-profile": "AUTH_PROFILE_SHA_512_1"
    },
    {
      "name": "if1-0/0/0/100",
      "metric": 20000,
      "network-type": "p2p",
      "authentication-profile": "AUTH_PROFILE_SHA_512_1"
    },
    {
      "name": "if1-0/0/1/1",
      "metric": 40000,
      "network-type": "p2p",
      "authentication-profile": "AUTH_PROFILE_SHA_512_1"
    },
    {
      "name": "if1-0/0/1/100",
      "metric": 30000,
      "authentication-profile": "AUTH_PROFILE_SHA_512_1"
    },
    {
      "name": "if1-0/0/4/1",
      "metric": 60000
    },
    {
      "name": "lo-0/0/0/1"
    },
    {
      "name": "lo-0/0/0/2"
    }
  ]
}

```



## Example 2: OSPF IPv6 Interface Configuration

```

supervisor@rtbrick>SPINE01: cfg> show config instance default protocol ospf address-family ipv6 instance-id 0
area 0.0.0.0 interface
{
  "rtbrick-config:interface": [
    {
      "name": "ifl-0/0/0/1",
      "authentication-profile": "AUTH_PROFILE_SHA_512_1"
    },
    {
      "name": "ifl-0/0/0/100",
      "metric": 20000,
      "network-type": "p2p",
      "authentication-profile": "AUTH_PROFILE_SHA_512_1"
    },
    {
      "name": "ifl-0/0/1/1",
      "metric": 40000,
      "network-type": "p2p",
      "authentication-profile": "AUTH_PROFILE_SHA_512_1"
    },
    {
      "name": "ifl-0/0/1/100",
      "metric": 30000,
      "authentication-profile": "AUTH_PROFILE_SHA_512_1"
    },
    {
      "name": "ifl-0/0/4/1",
      "metric": 60000
    },
    {
      "name": "lo-0/0/0/1"
    },
    {
      "name": "lo-0/0/0/2"
    }
  ]
}
    
```

## OSPF Metric Configuration

Metric is the cost that OSPF uses to calculate and identify the best paths to other routers.

## Syntax

**set instance** <instance-name> **protocol ospf address-family** <afi> <attribute> <value>

Attribute	Description
<afi>	Specifies the Address family identifier (AFI), either IPv4 or IPv6.
<afi> instance-id <instance-id>	Specifies the instance ID. When using an IPv6 address family with OSPFv3, an instance ID ranging from 0 to 31 must be specified.

Attribute	Description
metric <metric>	<p>OSPF address-family metric. Allowed range: 1 - 65535. Default: 10000.</p> <div style="border-left: 1px solid black; padding-left: 10px; margin-left: 40px;">  <p>If you configure the metric at the address family, it will be applicable to the configured areas of the address-family. If you configure a metric for an area, this configured metric value will take precedence over the address-family metric configurations of this area.</p> </div> <p>If you specify a metric value for an area on an interface will override any area and address-family metric configurations for this area.</p>

### Example 1: OSPF IPv4 Metric Configuration

```

supervisor@rtbrick>SPINE01: cfg> show config instance default protocol ospf address-family ipv4 area 0.0.0.0
metric
{
  "rtbrick-config:metric": 1000
}
    
```

### Example 2: OSPF IPv6 Metric Configuration

```

supervisor@rtbrick>SPINE01: cfg> show config instance default protocol ospf address-family ipv6 instance-id 0
area 0.0.0.0 metric
{
  "rtbrick-config:metric": 1000
}
    
```

## OSPF Opaque Capability Configuration

Enables opaque link-state advertisements. Routers in the OSPF network can receive and advertise Type-9, Type-10 and Type-11 opaque LSAs.

### Syntax

**set instance** <instance-name> **protocol ospf address-family ipv4** <attribute> <value>

Attribute	Description
opaque-capability <enable   disable>	Enable or disable opaque LSA advertisement and reception. Set as 'enable' to enable the router to receive and advertise opaque LSAs.

### Example: OSPF Opaque Capability Configuration

```

supervisor@rtbrick>SPINE01: cfg> show config instance default protocol ospf address-family ipv4 opaque-
capability
{
  "rtbrick-config:opaque-capability": "enable"
}

```

## Segment Routing Configuration

Enable segment routing for OSPF. For configuring segment routing, you must enable the opaque capability by defining it as 'true'. For information, see the section: "Opaque Capability Configuration".

## Syntax

**set instance** <instance-name> **protocol ospf address-family** <afi> <attribute> <value>

Attribute	Description
<afi>	Specifies the Address family identifier (AFI), either IPv4 or IPv6.
<afi> instance-id <instance-id>	Specifies the instance ID. When using an IPv6 address family with OSPFv3, an instance ID ranging from 0 to 31 must be specified.
segment-routing srgb base <value>	Specifies the segment routing global block (SRGB) in source packet routing. SRGB is used for prefix SIDs.  Supported MPLS label values are 0 - 1048575. The reserved MPLS label range is 0 - 15. In RBFS, BGP uses the label range 20000 - 100000. It is recommended to assign label values outside of these reserved ranges to avoid conflicts.
segment-routing srgb range <value>	OSPF system range of labels from the base label.

Attribute	Description
segment-routing status <disable   enable>	Enable or disable the segment routing feature. By default, the status is disabled.

### Example 1: OSPF IPv4 Segment routing Configuration

```

supervisor@rtbrick>SPINE01: cfg> show config instance default protocol ospf address-family ipv4 segment-
routing
{
  "rtbrick-config:segment-routing": {
    "status": "enable",
    "srgb": {
      "base": 1000,
      "range": 1000
    }
  }
}
    
```

### Example 2: OSPF IPv6 Segment routing Configuration

```

supervisor@rtbrick>SPINE01: cfg> show config instance default protocol ospf address-family ipv6 instance-id 0
segment-routing
{
  "rtbrick-config:segment-routing": {
    "status": "enable",
    "srgb": {
      "base": 1000,
      "range": 1000
    }
  }
}
    
```

## OSPF Redistribution Configuration

Enable route redistribution for the routes originating from other sources or protocols such as **BGP**, **Direct**, **IPoE**, **IS-IS**, **PPP**, and **Static**.

## Syntax

**set instance** <instance-name> **protocol ospf** <afi> <attribute> <value>

Attribute	Description
<afi>	Specifies the Address family identifier (AFI), either IPv4 or IPv6.
<afi> instance-id <instance-id>	Specifies the instance ID. When using an IPv6 address family with OSPFv3, an instance ID ranging from 0 to 31 must be specified.

Attribute	Description
redistribute <protocol>	Specifies the source protocol from which the routes are to be redistributed. The available options include <b>BGP</b> , <b>Direct</b> , <b>IPoE</b> , <b>IS-IS</b> , <b>PPP</b> , and <b>Static</b> .
metric <metric>	Specifies the metric value for the redistributed routes
metric-type <type 1   type 2>	Specifies the external metric type for the redistributed routes.
policy	Specifies the name of the policy map. The redistribute attach point allows routes from other sources to be advertised by OSPFv2.

### Example 1: OSPF IPV4 BGP Redistribution Configuration

```

supervisor@rtbrick>SPINE01: cfg> show config instance default protocol ospf address-family ipv4 redistribute
bgp
{
  "rtbrick-config:redistribute": [
    {
      "source": "bgp",
      "metric": 2000
    }
  ]
}

```

### Example 2: OSPF IPv6 Redistribution Policy

```

supervisor@rtbrick>SPINE01: cfg> show config instance default protocol ospf address-family ipv6 instance-id 0
redistribute direct
{
  "rtbrick-config:redistribute": [
    {
      "source": "direct",
      "policy": "ospf_policy_1"
    }
  ]
}

```

## ECMP Routing Configuration

ECMP (equal-cost multiple paths) routing is a mechanism in which routers forward packets to a destination using the multiple available best paths. This mechanism can increase network bandwidth substantially by load-balancing traffic through multiple best paths.

## Syntax

**set instance** <instance-name> **protocol ospf address-family** <afi> <attribute> <value>

Attribute	Description
<afi>	Specifies the Address family identifier (AFI), either IPv4 or IPv6.
<afi> instance-id <instance-id>	Specifies the instance ID. When using an IPv6 address family with OSPFv3, an instance ID ranging from 0 to 31 must be specified.
<max-load-balance>	Maximum number of equal-cost multiple paths to be calculated for load balancing. Default: 16. Allowed range: 1 - 255.

### Example: OSPF IPv4 ECMP Routing Configuration

```
supervisor@rtbrick>SPINE01: cfg> show config instance default protocol ospf address-family ipv4 max-load-balance
{
  "rtbrick-config:max-load-balance": 100
}
```

### Example: OSPF IPv6 ECMP Routing Configuration

```
supervisor@rtbrick>SPINE01: cfg> show config instance default protocol ospf address-family ipv6 instance-id 0 max-load-balance
{
  "rtbrick-config:max-load-balance": 100
}
```

## OSPF Authentication Configuration

OSPF supports the secure exchange of routing updates through authentication. You can enable authentication by attaching an authentication profile at the area or interface level. OSPF allows multiple keys to be attached to prevent session interruption.

The table below shows the authentication types supported by OSPFv2 and v3.

Authentication Type	OSPFv2	OSPFv3
Clear Text	Yes	No

Authentication Type	OSPFv2	OSPFv3
HMAC-SHA-1	Yes	Yes
HMAC-SHA-256	Yes	Yes
HMAC-SHA-384	Yes	Yes
HMAC-SHA-512	Yes	Yes
MD5	Yes	No



To authenticate OSPF, there must be a global authentication profile present.

## Configuring an Authentication Profile

**set authentication-profile** <attribute> <value>

Attribute	Description
<name>	Specifies the authentication profile name.
<name> key <key-id>	Specifies the message digest key identifier to be used by the neighboring routers for the OSPF password authentication. Allowed range: 1 - 255.
<name> key <key-id> type <auth-type>	Specifies the type of authentication that is being used, such as MD5, HMAC-SHA-1, and others.
<name> key <key-id> plain-text <text>	Specifies the password in plain text format.
<name> key <key-id> encrypted-text <text>	Specifies the password in an encrypted text format.
<name> key prefer-key-id <key-id>	Preferred key-id configuration will be used while sending out the packet with the specified key.



- When an authentication profile is available, you can configure an authentication attachment point at the area or interface level.
- When an authentication profile contains multiple key-IDs, and the preferred key-ID is not configured, the packet is sent using the highest key-ID.

In the example below, the authentication profile "auth-profile1" has **md5**, **hmac-**

sha-1, and clear-text enabled. The preferred key-id being 20, the hmac-sha-1 method will be used for authentication.

```
"rtbrick-config:instance": [
  {
    "name": "default",
    "address-family": [
      {
        "afi": "ipv4",
        "safi": "unicast"
      },
      {
        "afi": "ipv6",
        "safi": "unicast"
      }
    ],
    "protocol": {
      "ospf": {
        "address-family": {
          "ipv6": {
            "instance-id": [
              {
                "instance-id": 0,
                "router-id": "192.168.0.10",
                "max-load-balance": 100,
                "metric": 1000,
                "segment-routing": {
                  "status": "enable",
                  "srgb": {
                    "base": 1000,
                    "range": 1000
                  }
                }
              }
            ],
            "redistribute": [
              {
                "source": "bgp",
                "metric": 2000
              },
              {
                "source": "direct",
                "policy": "ospf_policy_1"
              }
            ],
            "area": [
              {
                "area-id": "0.0.0.0",
                "metric": 1000,
                "interface": [
                  {
                    "name": "if1-0/0/0/1",
                    "authentication-profile": "AUTH_PROFILE_SHA_512_1"
                  },
                  {
                    "name": "if1-0/0/0/100",
                    "metric": 20000,
                    "network-type": "p2p",
                    "authentication-profile": "AUTH_PROFILE_SHA_512_1"
                  }
                ]
              }
            ]
          }
        }
      }
    }
  }
]
```



## 2.7.3. OSPF Operational Commands

### OSPF Show Commands

#### OSPF Summary

Displays the OSPF protocol summary information.

Syntax:

**show ospf summary** <options>

Option	Description
-	Without any option, the command displays the information for all instances and address families.
instance <instance-name>	OSPF summary information for the given instance.
instance <instance-name> <afi>	OSPF summary information for the specified instance and address family. Supported AFI values are 'ipv4' and 'ipv6'.
<afi> instance <instance-name>	OSPF summary information for the specified address family and instance. Supported AFI values are 'ipv4' and 'ipv6'.

Example: OSPF summary for the default instance

```

supervisor@rtbrick>SPINE01: op> show ospf summary
Global Information:
  Neighbor State Information:
    Full      : 12
    Loading   : 0
    Exchange  : 0
    ExStart   : 0
    TwoWay    : 2
    Init      : 0
    Attempt   : 0
    Down      : 0
Instance: default, Address family: ipv4
  General information:
    Router ID: 192.168.0.10, Area count: 1, Flood interval: 1000ms
    Opaque capability: True, Segment routing capability: True
    Flags: -|-|-|-|-, Cost: 10000
    SPF initial delay: 50ms, SPF short delay: 200ms, SPF long delay: 5000ms
  Area: 0.0.0.0
    Interface count: 7
      Interface: if1-0/0/0/1
        Address: 12.0.0.1, State: BDR, Type: broadcast, Priority: 1
    
```

```

    Designated router: 12.0.0.2, Backup designated router: 12.0.0.1
    Hello interval: 10s, Dead interval: 40s
    Cost: 10000, MTU: 1500
Interface: ifl-0/0/0/100
    Address: 12.1.0.1, State: P2P, Type: p2p, Priority: 1
    Designated router: 0.0.0.0, Backup designated router: 0.0.0.0
    Hello interval: 10s, Dead interval: 40s
    Cost: 20000, MTU: 1500
Interface: ifl-0/0/1/1
    Address: 12.2.0.0, State: P2P, Type: p2p, Priority: 1
    Designated router: 0.0.0.0, Backup designated router: 0.0.0.0
    Hello interval: 10s, Dead interval: 40s
    Cost: 40000, MTU: 1500
Interface: ifl-0/0/1/100
    Address: 12.3.0.1, State: BDR, Type: broadcast, Priority: 1
    Designated router: 12.3.0.2, Backup designated router: 12.3.0.1
    Hello interval: 10s, Dead interval: 40s
    Cost: 30000, MTU: 1500
Interface: ifl-0/0/4/1
    Address: 11.0.0.1, State: DROther, Type: broadcast, Priority: 1
    Designated router: 11.0.0.5, Backup designated router: 11.0.0.4
    Hello interval: 10s, Dead interval: 40s
    Cost: 60000, MTU: 1500
Interface: lo-0/0/0/1
    Address: 192.168.0.10, State: P2P, Type: p2p, Priority: 1
    Designated router: 0.0.0.0, Backup designated router: 0.0.0.0
    Hello interval: 10s, Dead interval: 40s
    Cost: 10000, MTU:
Interface: lo-0/0/0/2
    Address: 192.168.0.11, State: P2P, Type: p2p, Priority: 1
    Designated router: 0.0.0.0, Backup designated router: 0.0.0.0
    Hello interval: 10s, Dead interval: 40s
    Cost: 10000, MTU:
Instance: default, Address family: ipv6, Instance ID: 0
General information:
    Router ID: 192.168.0.10, Area count: 1, Flood interval: 1000ms
    Opaque capability: True, Segment routing capability: True
    Flags: -|-|-|-|-, Cost: 10000
    SPF initial delay: 50ms, SPF short delay: 200ms, SPF long delay: 5000ms
Area: 0.0.0.0
Interface count: 7
Interface: ifl-0/0/0/1
    Address: fe80::7810:99ff:fec0:0, State: BDR, Type: broadcast, Priority: 1
    Designated router: 192.168.0.20, Backup designated router: 192.168.0.10
    Hello interval: 10s, Dead interval: 40s
    Cost: 10000, MTU: 1500
Interface: ifl-0/0/0/100
    Address: fe80::65:7810:99ff:fec0:0, State: P2P, Type: p2p, Priority: 1
    Designated router: 0.0.0.0, Backup designated router: 0.0.0.0
    Hello interval: 10s, Dead interval: 40s
    Cost: 20000, MTU: 1500
Interface: ifl-0/0/1/1
    Address: fe80::7810:99ff:fec0:1, State: P2P, Type: p2p, Priority: 1
    Designated router: 0.0.0.0, Backup designated router: 0.0.0.0
    Hello interval: 10s, Dead interval: 40s
    Cost: 40000, MTU: 1500
Interface: ifl-0/0/1/100
    Address: fe80::65:7810:99ff:fec0:1, State: BDR, Type: broadcast, Priority: 1
    Designated router: 192.168.0.20, Backup designated router: 192.168.0.10
    Hello interval: 10s, Dead interval: 40s
    Cost: 30000, MTU: 1500
Interface: ifl-0/0/4/1
    Address: fe80::7810:99ff:fec0:4, State: DROther, Type: broadcast, Priority: 1

```

```

    Designated router: 192.168.0.50, Backup designated router: 192.168.0.40
    Hello interval: 10s, Dead interval: 40s
    Cost: 60000, MTU: 1500
Interface: lo-0/0/0/1
    Address: 192:168::10, State: P2P, Type: p2p, Priority: 1
    Designated router: 0.0.0.0, Backup designated router: 0.0.0.0
    Hello interval: 10s, Dead interval: 40s
    Cost: 10000, MTU: 0
Interface: lo-0/0/0/2
    Address: 192:168::11, State: P2P, Type: p2p, Priority: 1
    Designated router: 0.0.0.0, Backup designated router: 0.0.0.0
    Hello interval: 10s, Dead interval: 40s
    Cost: 10000, MTU: 0
<...>
    
```

## OSPF Hostname

Displays the OSPF hostname information.

Syntax:

### **show ospf hostname**

Example: OSPF hostname for the default instance

```

supervisor@rtbrick>SPINE01: op> show ospf hostname
Instance          AFI   Instance ID   Router ID      Hostname
default           ipv4                192.168.0.10   Router1
default           ipv6   0              192.168.0.10   Router1
    
```

## OSPF Interface

Displays OSPF interface information.

Syntax:

### **show ospf interface <options>**

Option	Description
-	Without any option, the command displays the interface information for all instances and address families.
detail	Displays the detailed interface information.

Option	Description
<interface-name> detail	Displays detailed information for the specified interface. Also, for the specified interface, you can display interface information with filter options: detail, ipv4, and ipv4 detail.
instance <instance-name>	OSPF interface information for the given instance. Also, for the specified instance, you can display interface information with filter options: interface name, detail, and ipv4 detail.
instance <instance-name> <interface-name>	Displays information for a specified interface for a given instance.
instance <instance-name> <interface-name> detail	Displays detailed information for a specified interface for a given instance.
<afi>	Displays OSPF interface information for the specified address family. Supported AFI values are 'ipv4' and 'ipv6'. You can display interface information for the specified address family using filters such as interface name, detail, and instance.

Example 1: OSPF interface information for the default instance

```

supervisor@rtbrick>SPINE01: op> show ospf interface
Instance: default, Address family: ipv4
  Interface          Area          IP Address          State      Type      Cost
Priority DR          BDR           MTU
  if1-0/0/0/1       0.0.0.0       12.0.0.1            BDR        broadcast 10000 1
12.0.0.2            12.0.0.1      1500
  if1-0/0/0/100     0.0.0.0       12.1.0.1            P2P        p2p        20000 1
0.0.0.0             0.0.0.0       1500
  if1-0/0/1/1       0.0.0.0       12.2.0.0            P2P        p2p        40000 1
0.0.0.0             0.0.0.0       1500
  if1-0/0/1/100     0.0.0.0       12.3.0.1            BDR        broadcast 30000 1
12.3.0.2            12.3.0.1      1500
  if1-0/0/4/1       0.0.0.0       11.0.0.1            DROther    broadcast 60000 1
11.0.0.5            11.0.0.4      1500
  lo-0/0/0/1        0.0.0.0       192.168.0.10        P2P        p2p        10000 1
0.0.0.0             0.0.0.0
  lo-0/0/0/2        0.0.0.0       192.168.0.11        P2P        p2p        10000 1
0.0.0.0             0.0.0.0
Instance: default, Address family: ipv6, Instance ID: 0
  Interface          Area          IP Address          State      Type      Cost
Priority DR          BDR           MTU
  if1-0/0/0/1       0.0.0.0       fe80::7810:99ff:fec0:0 BDR        broadcast 10000 1
192.168.0.20        192.168.0.10 1500
  if1-0/0/0/100     0.0.0.0       fe80::65:7810:99ff:fec0:0 P2P        p2p        20000 1
0.0.0.0             0.0.0.0       1500
  if1-0/0/1/1       0.0.0.0       fe80::7810:99ff:fec0:1 P2P        p2p        40000 1
0.0.0.0             0.0.0.0       1500
  if1-0/0/1/100     0.0.0.0       fe80::65:7810:99ff:fec0:1 BDR        broadcast 30000 1
192.168.0.20        192.168.0.10 1500
  if1-0/0/4/1       0.0.0.0       fe80::7810:99ff:fec0:4 DROther    broadcast 60000 1
192.168.0.50        192.168.0.40 1500
  lo-0/0/0/1        0.0.0.0       192:168::10         P2P        p2p        10000 1

```

```

0.0.0.0      0.0.0.0      0
10-0/0/0/2  0.0.0.0      192:168::11      P2P      p2p      10000      1
0.0.0.0      0.0.0.0      0
    
```

## Example 2: OSPF interface detailed information

```

supervisor@rtbrick>SPINE01: cfg> show ospf interface if1-0/0/1/100 detail
Instance: default, Address family: ipv4
  Interface      Area      IP Address      State      Type      Cost
Priority DR      BDR      MTU
if1-0/0/1/100   0.0.0.0   12.3.0.1        BDR        broadcast 30000 1
12.3.0.2        12.3.0.1 1500
Instance: default, Address family: ipv6, Instance ID: 0
  Interface      Area      IP Address      State      Type      Cost
Priority DR      BDR      MTU
if1-0/0/1/100   0.0.0.0   fe80::65:7810:99ff:fec0:1 BDR        broadcast 30000 1
192.168.0.20    192.168.0.10 1500
    
```

## OSPF Neighbor

Displays OSPF neighbor information.

Syntax:

**show ospf neighbor** <options>

Option	Description
-	Without any option, the command displays the neighbor information for all instances.
instance <instance-name>	OSPF neighbor information for the given instance.
area <area-id>	OSPF neighbor information for the given area.
detail	Displays the detailed neighbor information.
interface <interface-name>	Displays the neighbor information for a specified interface.
instance <instance-name> detail	Displays detailed OSPF neighbor information for the given instance.
instance <instance-name> interface <interface-name>	Displays OSPF neighbor information for the specified interface for the given instance.
instance <instance-name> interface <interface-name> detail	Displays detailed OSPF neighbor information for the specified interface for the given instance.

Option	Description
interface <interface-name> detail	Displays detailed neighbor information for a specified interface.
<afi>	Displays OSPF neighbor information for the specified address family. Supported AFI values are 'ipv4' and 'ipv6'. You can display neighbor information for the specified address family using filters such as interface name, detail, and instance.
log	Logs neighbor event information.

Example: OSPF neighbor information for the default instance

```

supervisor@rtbrick>SPINE01: op> show ospf neighbor
Instance: default, Address family: ipv4
  Address          Interface          Router          Area          State          Priority  DR
  BDR             Uptime            Expires
  12.0.0.2         12.0.0.1          ifl-0/0/0/1    192.168.0.20  0.0.0.0        Full      1
  12.0.0.2         12.0.0.1          0d:01h:38m:12s 33s
  12.2.0.1         0.0.0.0           ifl-0/0/1/1    192.168.0.20  0.0.0.0        Full      1
  0.0.0.0          0.0.0.0           0d:01h:38m:57s 33s
  11.0.0.3         11.0.0.4          ifl-0/0/4/1    192.168.0.30  0.0.0.0        TwoWay    1
  11.0.0.5         11.0.0.4          never          34s
  11.0.0.4         11.0.0.4          ifl-0/0/4/1    192.168.0.40  0.0.0.0        Full      1
  11.0.0.5         11.0.0.4          0d:01h:38m:11s 34s
  11.0.0.5         11.0.0.4          ifl-0/0/4/1    192.168.0.50  0.0.0.0        Full      1
  11.0.0.5         11.0.0.4          0d:01h:38m:16s 34s
  12.1.0.2         0.0.0.0           ifl-0/0/0/100  192.168.0.20  0.0.0.0        Full      1
  0.0.0.0          0.0.0.0           0d:01h:38m:57s 33s
  12.3.0.2         12.3.0.1          ifl-0/0/1/100  192.168.0.20  0.0.0.0        Full      1
  12.3.0.2         12.3.0.1          0d:01h:38m:12s 33s
Instance: default, Address family: ipv6, Instance ID: 0
  Address          Interface          Router          Area          State          Priority  DR
  BDR             Uptime            Expires
  fe80::7845:9aff:fec0:0  ifl-0/0/0/1    192.168.0.20  0.0.0.0        Full      1
  192.168.0.20     192.168.0.10    0d:01h:38m:12s 33s
  fe80::7845:9aff:fec0:1  ifl-0/0/1/1    192.168.0.20  0.0.0.0        Full      1
  0.0.0.0          0.0.0.0           0d:01h:38m:52s 33s
  fe80::780d:96ff:fec0:4  ifl-0/0/4/1    192.168.0.30  0.0.0.0        TwoWay    1
  192.168.0.50     192.168.0.40    never          34s
  fe80::7801:34ff:fec0:5  ifl-0/0/4/1    192.168.0.40  0.0.0.0        Full      1
  192.168.0.50     192.168.0.40    0d:01h:38m:16s 34s
  fe80::7865:1aff:fec0:6  ifl-0/0/4/1    192.168.0.50  0.0.0.0        Full      1
  192.168.0.50     192.168.0.40    0d:01h:38m:16s 34s
  fe80::65:7845:9aff:fec0:0  ifl-0/0/0/100  192.168.0.20  0.0.0.0        Full      1
  0.0.0.0          0.0.0.0           0d:01h:38m:52s 33s
  fe80::65:7845:9aff:fec0:1  ifl-0/0/1/100  192.168.0.20  0.0.0.0        Full      1
  192.168.0.20     192.168.0.10    0d:01h:38m:12s 33s

```

**OSPF Segment Routing**

Displays OSPF segment routing information.

Syntax:

**show ospf segment-routing <options>**

Option	Description
-	Without any option, the command displays the neighbor information for all instances.
global-block	Displays Segment routing global block (SRGB) information
global-block instance <instance-name>	Displays Segment routing global block (SRGB) information for the specified instance
global-block instance <instance-name> <afi>	Displays Segment routing global block (SRGB) information for the specified instance address family. Supported AFI values are 'ipv4' and 'ipv6'.
prefix-segment	Displays the OSPF prefix segment information
prefix-segment <instance> Displays the OSPF prefix segments for the specified instance and address family	prefix-segment <instance-name> <afi>

Example: OSPF neighbor information for the default instance

```

supervisor@rtbrick>SPINE01: op> show ospf segment-routing
<...>
    
```

## OSPF Database

Displays information from OSPF link-state database that contains data about link-state advertisements (LSAs).

Syntax:

**show ospf database** <options>

Option	Description
advertising-router <router-id>	Displays LSDB information for the specified advertising router.
advertising-router <router-id> detail	Displays the detailed LSDB information for the specified advertising router.

Option	Description
advertising-router <router-id> ls-id <ls-id>	Displays the LSDB information for the specified link-state ID for the advertising router.
advertising-router <router-id> ls-type external	Displays the LSDB information for the specified LSA type for the advertising router. Link-state advertisement types include external, network, router, and summary.
detail	Displays detailed information from LSDB.
instance <instance-name>	Displays OSPF database information for the given instance.
ls-id <ls-id>	OSPF database information for a specific link-state identifier.
ls-type <type>	OSPF database information for the specified link-state type. Link-state advertisement types include external, network, router and summary.
area <area-id>	Displays database information for the specified OSPF area.
area <area-id> advertising-router <router-id>	Displays LSDB information for the specified advertising router for a specified OSPF area.
area <area-id> detail	Displays detailed LSDB information for the specified OSPF area.
area <area-id> ls-id <ls-id>	Displays LSDB information for the specified link-state identifier for the specified OSPF area.
area <area-id> ls-type <type>	Displays LSDB information for the specified link-state type for the specified OSPF area. Link-state advertisement types include external, network, router, and summary.
instance <instance-name> advertising router <router-id>	Displays LSDB information for the specified advertising router for the given instance.
instance <instance-name> area <area-id>	Displays LSDB information for the specified area for the given instance.



Option	Description
instance <instance-name> ls-id <ls-id>	Displays LSDB information for the specified link-state identifier for the given instance.
instance <instance-name> ls-type <type>	Displays LSDB information for the specified type of the given instance. Link-state advertisement types include external, network, router and summary.
<afi>	Displays LSDB neighbor information for the specified address family. Supported AFI values are 'ipv4' and 'ipv6'. You can display LSDB information for the specified address family using filters such as interface name, detail, and instance.

### Example 1: OSPF database information for the default instance

```

supervisor@rtbrick>SPINE01: cfg> show ospf database
Instance: default, Address family: ipv4, Area: 0.0.0.0
  Type          Link State ID  Advertising Router  Age      Sequence  Checksum
Cost
  Router        192.168.0.10   192.168.0.10       578      0x80000008 0x262a
-
  Router        192.168.0.20   192.168.0.20       579      0x80000009 0xddd7
-
  Router        192.168.0.30   192.168.0.30       584      0x80000007 0x92be
-
  Network       11.0.0.5       192.168.0.50       583      0x80000004 0xc9b1
-
  Network       12.0.0.2       192.168.0.20       579      0x80000004 0x7962
-
  Network       12.3.0.2       192.168.0.20       579      0x80000004 0xdc7a
-
  Network       23.0.0.3       192.168.0.30       585      0x80000004 0x9917
-
  Summary-Network
15000          24.0.1.0       192.168.0.20       623      0x80000004 0xbc36
15000          Summary-Network
25000          24.0.1.0       192.168.0.40       623      0x80000004 0x449a
25000          Summary-Network
25000          24.0.1.0       192.168.0.50       578      0x80000005 0x795
Instance: default, Address family: ipv4
  Type          Link State ID  Advertising Router  Age      Sequence  Checksum
Cost
  External      200.0.1.0     192.168.0.60       619      0x80000004 0xba29
16777214
  External      200.0.1.60    192.168.0.60       619      0x80000004 0x6047
16777214
  External      200.0.1.61    192.168.0.60       619      0x80000004 0x5650
16777214
Instance: default, Address family: ipv6, Instance ID: 0, Area: 0.0.0.0
  Type          Link State ID  Advertising Router  Age      Sequence  Checksum
Cost
  OSPFv3-Router 0.0.0.0       192.168.0.10       578      0x80000007 0xb041
-
  OSPFv3-Router 0.0.0.0       192.168.0.20       579      0x80000007 0x1085
-
  OSPFv3-Router 0.0.0.0       192.168.0.30       580      0x80000007 0xe89
-
  Inter-Area-Prefix
15000          1.0.0.0       192.168.0.20       624      0x80000004 0xd4b7
15000          Inter-Area-Prefix
25000          1.0.0.0       192.168.0.30       624      0x80000004 0x2208
25000          Inter-Area-Prefix
25000          1.0.0.0       192.168.0.40       623      0x80000004 0x5c1c
    
```

```

15000
  Inter-Area-Prefix      1.0.0.0      192.168.0.50      623      0x80000004      0xf9ee
10000
  Intra-Area-Prefix      1.0.0.0      192.168.0.10      578      0x80000006      0x7af2
-
  Intra-Area-Prefix      1.0.0.0      192.168.0.20      579      0x80000005      0xf646
-
  Intra-Area-Prefix      1.0.0.0      192.168.0.30      580      0x80000006      0x56b2
-
  Link                    6.0.8.0      192.168.0.10      583      0x80000005      0x7d82
-
  Link                    6.0.8.0      192.168.0.20      584      0x80000005      0xa51a
-
  Link                    6.0.32.3     192.168.0.10      623      0x80000004      0x17d2
-
  Link                    6.0.32.3     192.168.0.20      624      0x80000004      0x3f6a
-
Instance: default, Address family: ipv6, Instance ID: 0
Type          Link State ID  Advertising Router  Age      Sequence  Checksum
Cost
  OSPFv3-External  1.0.0.0      192.168.0.60      619     0x80000004  0xa367
16777214
  OSPFv3-External  2.0.0.0      192.168.0.60      619     0x80000004  0x738a
16777214
<...>

```

### Example 2: OSPF database detailed information

```

supervisor@rtbrick>SPINE01: cfg> show ospf database detail
Instance: default, Address family: ipv4, Area: 0.0.0.0 LSAs
LSA ID: 192.168.0.10
Advertising router: 192.168.0.10, LSA type: Router
Sequence number: 0x80000008, Checksum: 0x262a, LSA age: 719s
Length: 132, Options: *|---|---|E|*, Flags: -|-|-|
Number of links: 9
  Link ID: 12.0.0.2
    Link data: 12.0.0.1, Type: Transit
    Type of service: 0, Metric: 10000
  Link ID: 192.168.0.20
    Link data: 12.1.0.1, Type: P2P
    Type of service: 0, Metric: 20000
  Link ID: 12.1.0.0
    Link data: 255.255.255.252, Type: Stub
    Type of service: 0, Metric: 20000
  Link ID: 192.168.0.20
    Link data: 12.2.0.0, Type: P2P
    Type of service: 0, Metric: 40000
  Link ID: 12.2.0.0
    Link data: 255.255.255.254, Type: Stub
    Type of service: 0, Metric: 40000
  Link ID: 12.3.0.2
    Link data: 12.3.0.1, Type: Transit
    Type of service: 0, Metric: 30000
  Link ID: 11.0.0.5
    Link data: 11.0.0.1, Type: Transit
    Type of service: 0, Metric: 60000
  Link ID: 192.168.0.10
    Link data: 255.255.255.255, Type: Stub
    Type of service: 0, Metric: 10000
  Link ID: 192.168.0.11
    Link data: 255.255.255.255, Type: Stub
    Type of service: 0, Metric: 10000
LSA ID: 192.168.0.20
Advertising router: 192.168.0.20, LSA type: Router, Router ID: 192.168.0.20

```

```

Sequence number: 0x80000009, Checksum: 0xdd7, LSA age: 720s
Interface: if1-0/0/0/100, Neighbor address: 12.1.0.2
Length: 156, Options: *|---|---|E|*, Flags: ---|B
Number of links: 11
  Link ID: 12.0.0.2
    Link data: 12.0.0.2, Type: Transit
    Type of service: 0, Metric: 10000
  Link ID: 192.168.0.10
    Link data: 12.1.0.2, Type: P2P
    Type of service: 0, Metric: 20000
  Link ID: 12.1.0.0
    Link data: 255.255.255.252, Type: Stub
    Type of service: 0, Metric: 20000
<...>
    
```

### Example 3: OSPF database for an advertising router

```

supervisor@rtbrick>SPINE01: cfg> show ospf database advertising-router 192.168.0.10
Instance: default, Address family: ipv4, Area: 0.0.0.0
  Type                Link State ID  Advertising Router      Age      Sequence  Checksum
Cost
  Router              192.168.0.10  192.168.0.10           791     0x80000008  0x262a
-
Instance: default, Address family: ipv6, Instance ID: 0, Area: 0.0.0.0
  Type                Link State ID  Advertising Router      Age      Sequence  Checksum
Cost
  OSPFv3-Router       0.0.0.0       192.168.0.10           791     0x80000007  0xb041
-
  Intra-Area-Prefix   1.0.0.0       192.168.0.10           791     0x80000006  0x7af2
-
  Link                6.0.8.0       192.168.0.10           796     0x80000005  0x7d82
-
  Link                6.0.32.3      192.168.0.10           836     0x80000004  0x17d2
-
  Link                6.8.8.0       192.168.0.10           836     0x80000004  0x677e
-
  Link                6.8.32.3      192.168.0.10           836     0x80000004  0x2b9b
-
  Link                6.32.8.0      192.168.0.10           795     0x80000006  0x3893
-
    
```

## OSPF SPF Result

Displays SPF results.

Syntax:

**show ospf spf result** <options>

Option	Description
-	Without any option, the command displays the SPF result of all instances.
area <area-id>	Displays SPF result for the specified area.
instance <instance-name>	Name of the instance

Option	Description
node-id <node-id>	Displays SPF result for the specified node identifier.
area <area-id> <node-id>	Displays SPF result for the specified node identifier for a specified area.
instance <instance-name> area <area-id>	Displays SPF result for the specified area for a given instance.
instance <instance-name> node-id <node-id>	Displays SPF result for the specified node identifier for a given instance.
<afi>	Displays SPF result information for the specified address family. Supported AFI values are 'ipv4' and 'ipv6'. You can display SPF result information for the specified address family using filters such as interface name, detail, and instance.

### Example 1: OSPF SPF Result for the default instance

```

supervisor@rtbrick>SPINE01: op> show ospf spf result
Instance: default, Address family: ipv4, Area: 0.0.0.0
  Node ID      Type      Cost      Advertising Router  Flags      Neighbor Node      Interface
  Nexthop
  12.0.0.2     network   10000     192.168.0.20       -|-|-|-   -                  local
  -
  12.3.0.2     network   30000     192.168.0.20       -|-|-|-   -                  local
  -
  23.0.0.3     network   20000     192.168.0.30       -|-|-|-   192.168.0.20      if1-0/0/0/1
  12.0.0.2     network   55000     192.168.0.50       -|-|-|-   192.168.0.20      if1-0/0/0/1
  12.0.0.2     router    0         192.168.0.10       -|-|-|-   -                  local
  -
  192.168.0.20 router    10000     192.168.0.20       -|-|-|B   192.168.0.20      if1-0/0/0/1
  12.0.0.2     router    20000     192.168.0.30       -|-|-|B   192.168.0.20      if1-0/0/0/1
  12.0.0.2     router    55000     192.168.0.40       -|-|-|B   192.168.0.20      if1-0/0/0/1
  12.0.0.2     router    55000     192.168.0.50       -|-|-|B   192.168.0.20      if1-0/0/0/1
  12.0.0.2
Instance: default, Address family: ipv6, Area: 0.0.0.0, Instance ID: 0
  Node ID      Type      Cost      Advertising Router  Flags      Neighbor Node      Interface
  Nexthop
  192.168.0.10 router    0         192.168.0.10       -|-|-|-   -                  local
  -
  6.0.8.0      network   10000     192.168.0.20       -|-|-|-   -                  local
  -
  6.8.32.3     network   30000     192.168.0.20       -|-|-|-   -                  local
  -
  192.168.0.20 router    10000     192.168.0.20       -|-|-|B   192.168.0.20      if1-0/0/0/1
  fe80::7845:9aff:fec0:0
  6.0.8.0      network   20000     192.168.0.30       -|-|-|-   192.168.0.20      if1-0/0/0/1
  fe80::7845:9aff:fec0:0
  192.168.0.30 router    20000     192.168.0.30       -|-|-|B   192.168.0.20      if1-0/0/0/1
  fe80::7845:9aff:fec0:0
  192.168.0.40 router    55000     192.168.0.40       -|-|-|B   192.168.0.20      if1-0/0/0/1
  fe80::7845:9aff:fec0:0
  6.48.8.0     network   55000     192.168.0.50       -|-|-|-   192.168.0.20      if1-0/0/0/1
  fe80::7845:9aff:fec0:0
    
```

```
192.168.0.50  router  55000  192.168.0.50  -|-|-|B  192.168.0.20  if1-0/0/0/1
fe80::7845:9aff:fec0:0
```

### Example 2: OSPF SPF Result for the specified node identifier for the given area

```
supervisor@rtbrick>SPINE01: op> show ospf spf result area 0.0.0.0 node-id 192.168.0.10
Instance: default, Address family: ipv4, Area: 0.0.0.0
  Node ID      Type      Cost      Advertising Router  Flags      Neighbor Node      Interface
NextHop
  192.168.0.10  router    0          192.168.0.10      -|-|-|-    -                  local
-
Instance: default, Address family: ipv6, Area: 0.0.0.0, Instance ID: 0
  Node ID      Type      Cost      Advertising Router  Flags      Neighbor Node      Interface
NextHop
  192.168.0.10  router    0          192.168.0.10      -|-|-|-    -                  local
-
```

## OSPF SPF Log

Displays SPF Log information.

Syntax:

**show ospf spf log** <options>

Option	Description
-	Without any option, the command displays the SPF log of all instances.
instance <instance-name>	Displays SPF log for the specified instance.
<afi>	Displays SPF log information for the specified address family. Supported AFI values are 'ipv4' and 'ipv6'. You can display SPF log information for the specified address family using filters such as interface name, detail, and instance.

### Example 1: OSPF SPF Result for the default instance

```
supervisor@rtbrick>SPINE01: op> show ospf spf log
Instance: default
  Router ID: 192.168.0.10
    Schedule timestamp: 2024-04-30 11:19:51, Area ID: 0.0.0.0, LSA type: Router
    Reason: Router LSA change, Back off timer: 50, LSA count: 1
    LS ID: 0.0.0.0, Number of schedule request: 1
    SPF start time: 2024-04-30 11:19:51, Number of nodes: 1, Number of links: 0
    Number of stub links: 0, SPF init time: 3lus, SPF run time: 394us
    Router LSA change count: 1, Network LSA change count: -
    Prefix changes: -, Sequence number: 1
  Router ID: 192.168.0.10
```

```

Schedule timestamp: 2024-04-30 11:19:51, Area ID: 0.0.0.0, LSA type: Router
Reason: Router LSA change, Back off timer: 50, LSA count: 1
LS ID: 192.168.0.10, Number of schedule request: 1
SPF start time: 2024-04-30 11:19:51, Number of nodes: 1, Number of links: 0
Number of stub links: 7, SPF init time: 7us, SPF run time: 311us
Router LSA change count: 1, Network LSA change count: -
Prefix changes: -, Sequence number: 2
Router ID: 192.168.0.10
Schedule timestamp: 2024-04-30 11:19:51, Area ID: 0.0.0.0, LSA type: Link
Reason: Unknown map - (value) 0xa, Back off timer: 200, LSA count: 5
LS ID: 6.0.8.0, Number of schedule request: 5
SPF start time: 2024-04-30 11:19:51, Number of nodes: 1, Number of links: 0
Number of stub links: 0, SPF init time: 7us, SPF run time: 172us
Router LSA change count: 1, Network LSA change count: -
Prefix changes: -, Sequence number: 3
Router ID: 192.168.0.20
Schedule timestamp: 2024-04-30 11:19:51, Area ID: 0.0.0.0, LSA type: Router
Reason: Router LSA change, Back off timer: 5000, LSA count: 6
LS ID: 192.168.0.20, Number of schedule request: 6
SPF start time: 2024-04-30 11:19:56, Number of nodes: 3, Number of links: 6
Number of stub links: 20, SPF init time: 35us, SPF run time: 182us
Router LSA change count: 7, Network LSA change count: -
Prefix changes: -, Sequence number: 4
<...>
    
```

## OSPF Route

Displays OSPF routing table information.

Syntax:

**show ospf route** <options>

Option	Description
-	Without any option, the command displays the OSPF route information for all instances.
area <area-id>	OSPF route information for the given area.
instance <instance-name>	OSPF route information for the given instance.
instance <instance-name> <afi>	Displays OSPF route information for the specified address family and instance. Supported AFI values are 'ipv4' and 'ipv6'.
instance <instance-name> <afi> <safi>	Displays OSPF route information for the specified address family (AFI), sub-address family (SAFI), and instance. Supported AFI values are 'ipv4' and 'ipv6'. Supported SAFI values are 'unicast', and 'labeled-unicast'.

Option	Description
instance <instance-name> label <label>	Displays OSPF route information for the specified label and instance.
instance <instance-name> mpls unicast label <label>   type <type>	Displays OSPF route information for the specified MPLS unicast label or type for the instance.
prefix <ip>	Displays OSPF route information for the specified match prefix.
type	Displays information for OSPF route type. The route types include <b>external-type-1</b> , <b>external-type-2</b> , <b>inter-area</b> , <b>intra-area</b> , and <b>ospf-direct</b> .
<afi> <safi>	Displays OSPF route information for the specified address family (AFI) and sub-address family (SAFI). Supported AFI values are 'ipv4' and 'ipv6'. Supported SAFI values are 'unicast', and 'labeled-unicast'
label <label>	Displays information about the OSPF-labeled routes.
mpls unicast <label   type>	Displays information about OSPF MPLS routes.
area-border	Displays the OSPF Area Border Router (ABR) information. Refer to section "3.1.7. OSPF Route ABR" for the interface configuration details.
autonomous-system-boundary	Displays Autonomous System Border Router information. Refer to section "3.1.7. OSPF Route ABR" for the interface configuration details.

### Example: OSPF route information for the default instance

```

supervisor@rtbrick>SPINE01: op> show ospf route
Instance: default, AFI: ipv4, SAFI: unicast
Prefix          Area          Type          Cost      Next Hop      Interface
11.0.0.0/24     0.0.0.0       intra-area    55000     12.0.0.2     if1-0/0/0/1
12.0.0.0/23     0.0.0.0       ospf-direct   10000     n/a          local
12.1.0.0/30     0.0.0.0       ospf-direct   20000     n/a          local
12.2.0.0/31     0.0.0.0       ospf-direct   40000     n/a          local
12.3.0.0/17     0.0.0.0       ospf-direct   30000     n/a          local
23.0.0.0/24     0.0.0.0       intra-area    20000     12.0.0.2     if1-0/0/0/1
23.1.0.0/24     0.0.0.0       intra-area    25000     12.0.0.2     if1-0/0/0/1
24.0.1.0/24     0.0.0.0       inter-area    25000     12.0.0.2     if1-0/0/0/1
24.1.1.0/24     0.0.0.0       intra-area    20000     12.0.0.2     if1-0/0/0/1
25.0.1.0/24     0.0.0.0       inter-area    35000     12.0.0.2     if1-0/0/0/1
192.168.0.10/32 0.0.0.0       ospf-direct   10000     n/a          local
192.168.0.11/32 0.0.0.0       ospf-direct   10000     n/a          local
192.168.0.20/32 0.0.0.0       intra-area    20000     12.0.0.2     if1-0/0/0/1
192.168.0.21/32 0.0.0.0       intra-area    20000     12.0.0.2     if1-0/0/0/1
    
```

```

200.0.1.60/32      external-type-1 16777215 12.0.0.2  ifl-0/0/0/1
200.0.1.61/32      external-type-1 16777215 12.0.0.2  ifl-0/0/0/1
200.0.1.0/24       external-type-1 16777215 12.0.0.2  ifl-0/0/0/1
200.0.2.60/32      external-type-1 16777215 12.0.0.2  ifl-0/0/0/1
200.0.2.61/32      external-type-1 16777215 12.0.0.2  ifl-0/0/0/1
200.0.2.0/24       external-type-1 16777215 12.0.0.2  ifl-0/0/0/1
Instance: default, AFI: ipv6, SAFI: unicast, Instance ID: 0
  Prefix          Interface      Area          Type          Cost          Next Hop
  11::/64         local         0.0.0.0       intra-area    55000
fe80::7845:9aff:fec0:0 ifl-0/0/0/1  0.0.0.0       ospf-direct   10000        n/a
  12::/64         local         0.0.0.0       ospf-direct   20000        n/a
  12:1::/64       local         0.0.0.0       ospf-direct   40000        n/a
  12:2::/64       local         0.0.0.0       ospf-direct   20000
  23::/64         local         0.0.0.0       intra-area    20000
fe80::7845:9aff:fec0:0 ifl-0/0/0/1  0.0.0.0       inter-area    25000
  24:0:1::/64     local         0.0.0.0       inter-area    20000
fe80::7845:9aff:fec0:0 ifl-0/0/0/1  0.0.0.0       inter-area    35000
  24:1:1::/64     local         0.0.0.0       inter-area    40000
fe80::7845:9aff:fec0:0 ifl-0/0/0/1  0.0.0.0
  25:0:1::/64     local         0.0.0.0       inter-area    40000
fe80::7845:9aff:fec0:0 ifl-0/0/0/1  0.0.0.0
  25:1:1::/64     local         0.0.0.0       inter-area    40000
fe80::7845:9aff:fec0:0 ifl-0/0/0/1  0.0.0.0
<...>

```

### OSPF Route Area Border

Displays the OSPF Area Border Router (ABR) information.

Syntax:

#### show ospf route area-border

Example: OSPF Route ABR information

```

supervisor@rtbrick>SPINE01: cfg> show ospf route area-border
 192.168.0.20      10000      192.168.0.20      -|-|B      ifl-0/0/0/1
12.0.0.2
 192.168.0.30      20000      192.168.0.30      -|-|B      ifl-0/0/0/1
12.0.0.2
 192.168.0.40      55000      192.168.0.40      -|-|B      ifl-0/0/0/1
12.0.0.2
 192.168.0.50      55000      192.168.0.50      -|-|B      ifl-0/0/0/1
12.0.0.2
 192.168.0.20      10000      192.168.0.20      -|-|B      ifl-0/0/0/1
fe80::7845:9aff:fec0:0 192.168.0.30 -|-|B      ifl-0/0/0/1
 192.168.0.30      20000      192.168.0.30      -|-|B      ifl-0/0/0/1
fe80::7845:9aff:fec0:0 192.168.0.40 -|-|B      ifl-0/0/0/1
 192.168.0.40      55000      192.168.0.40      -|-|B      ifl-0/0/0/1
fe80::7845:9aff:fec0:0 192.168.0.50 -|-|B      ifl-0/0/0/1
 192.168.0.50      55000      192.168.0.50      -|-|B      ifl-0/0/0/1
fe80::7845:9aff:fec0:0

```



## OSPF Route Autonomous System Boundary

Displays Autonomous System Boundary Router information.

Syntax:

### show ospf route autonomous-system-boundary

Example: OSPF Route ASBR information

```
supervisor@rtbrick>SPINE01: cfg> show ospf route autonomous-system-boundary
Instance: default, Address family: ipv4
  Node ID          Cost      Advertising Router  Flags      Interface
  Nexthop
  192.168.0.60     40000    192.168.0.20       12.0.0.2   if1-0/0/0/1
Instance: default, Address family: ipv6, Instance ID: 0
  Node ID          Cost      Advertising Router  Flags      Interface
  Nexthop
  192.168.0.60     40000    192.168.0.20       fe80::7845:9aff:fec0:0   if1-0/0/0/1
```

## OSPF LSA Request List

Displays the list of all link-state advertisements (LSAs) requests that have been sent or received by a router.

Syntax:

### show ospf request-list <options>

Option	Description
-	Without any option, this command displays the list of all link-state advertisement (LSA) requests that have been sent from the router.
detail	Provides detailed information on the requests that have been sent from the router.
area <area-id>	OSPF request-list information for the given area.
instance <instance-name>	OSPF request-list information for the given instance.
<afi>	Displays request-list information for the specified address family. Supported AFI values are 'ipv4' and 'ipv6'.

### Example 1: OSPF LSA requests sent to a neighbor

```

supervisor@rtbrick>SPINE01: op> show ospf request-list
Instance: default
Type           Link State ID   Advertising Router      Age      Sequence      Checksum
Summary-Network 11.0.0.0        198.51.100.20         42      0x80000003    0x76e5
Summary-Network 12.0.0.0        198.51.100.20         42      0x80000003    0x603d
Summary-Network 12.1.0.0        198.51.100.20         42      0x80000003    0x481f
Summary-Network 12.2.0.0        198.51.100.20         42      0x80000003    0x4aab
Summary-Network 12.3.0.0        198.51.100.20         42      0x80000003    0xc5e4
Summary-Network 23.0.0.0        198.51.100.20         42      0x80000003    0xd5bb
Summary-Network 23.1.0.0        198.51.100.20         42      0x80000003    0xca2a
    
```

### Example 2: Detailed information for OSPF LSA requests sent to a neighbor

```

supervisor@rtbrick>SPINE01: op> show ospf request-list detail
Instance: default LSAs
LSA ID: 11.0.0.0
  Advertising router: 198.51.100.20, LSA type: Summary-Network, Router ID: 192.168.0.20
  Sequence number: 0x80000003, Checksum: 0x76e5, LSA age: 42
  Interface: if1-0/0/0/1, Neighbor address: 25.0.1.2
  Length: 0, Options: *|---|---|---|*
LSA ID: 12.0.0.0
  Advertised router: 198.51.100.20, LSA type: Summary-Network, Router ID: 192.168.0.20
  Sequence number: 0x80000003, Checksum: 0x603d, LSA age: 42
  Interface: if1-0/0/0/1, Neighbor address: 25.0.1.2
  Length: 0, Options: *|---|---|---|*
LSA ID: 12.1.0.0
  Advertised router: 198.51.100.20, LSA type: Summary-Network, Router ID: 192.168.0.20
  Sequence number: 0x80000003, Checksum: 0x481f, LSA age: 42
  Interface: if1-0/0/0/1, Neighbor address: 25.0.1.2
  Length: 0, Options: *|---|---|---|*
LSA ID: 12.2.0.0
  Advertised router: 198.51.100.20, LSA type: Summary-Network, Router ID: 192.168.0.20
  Sequence number: 0x80000003, Checksum: 0x4aab, LSA age: 42
  Interface: if1-0/0/0/1, Neighbor address: 25.0.1.2
  Length: 0, Options: *|---|---|---|*
<...>
    
```

## OSPF Transmission List

Displays the list of all LSAs waiting to be re-sent or transmitted from the router.

Syntax:

**show ospf transmit-list** <option>

Option	Description
-	Without any option, this command displays the transmit list of all link-state advertisements (LSA).

Option	Description
area <area-id>	OSPF transmit-list information for the given area.
instance <instance-name>	OSPF transmit-list information for the given instance.
<afi>	Displays transmit-list information for the specified address family. Supported AFI values are 'ipv4' and 'ipv6'.

Example: OSPF LSA requests waiting to be transmitted.

```

supervisor@rtbrick>SPINE01: op> show ospf transmit-list
Instance: default, Area: 0.0.0.1, Interface: if1-0/0/4/1, Neighbor: 25.0.1.5
  LSA ID                LS type                Advertising router      Transmit interval
Retransmit count
  11.0.0.0              Summary-Network        198.51.100.20          5000                1
  12.0.0.0              Summary-Network        198.51.100.20          5000                1
  23.0.0.0              Summary-Network        198.51.100.20          5000                1
  12.1.1.0.0            Summary-Network        198.51.100.20          5000                1
  23.1.1.0.0            Summary-Network        198.51.100.20          5000                1
  12.2.2.0.0            Summary-Network        198.51.100.20          5000                1
  12.3.3.0.0            Summary-Network        198.51.100.20          5000                1
    
```

## OSPF Statistics

Displays OSPF statistics information.

Syntax:

**show ospf statistics** <options>

Option	Description
interface <interface-name>	Displays packet statistics information for the specified interface.
interface <interface-name> detail	Displays detailed packet statistics information for the specified interface.
neighbor <Neighbor-address>	Displays packet statistics information for the specified neighbor.
neighbor <Neighbor-address> <detail>	Displays detailed packet statistics information for the specified neighbor.
<afi>	Displays packet statistics information for the specified address family. Supported AFI values are 'ipv4' and 'ipv6'.

```

supervisor@rtbrick>SPINE01: op> show ospf statistics interface ifl-0/0/0/1 detail
Instance: default, Address family: ipv4
Interface: ifl-0/0/0/1, Peer address: 12.0.0.2
Hello packet:
  Received packets: 658, Sent packets: 659, Total errors: 0, Unsupported option: 0
  Area mismatch: 0, Area type option mismatch: 0, Dead interval mismatch: 0
  Hello interval mismatch: 0, Mask mismatch: 0, Self router ID: 0
  Obj add fail: 0, Source address mismatch: , Misc: 0
DD packet:
  Received packets: 3, Sent packets: 4, Total errors: 1, Unsupported option: 0
  Invalid state packet rcvd: 0, MTU mismatch: 0, DD obj add fail: 0, Misc: 0, Negotiation fail: 0
  Master bit mismatch: 0, Exchange state init pkt: 0, Capabilities mismatch: 0
  Expected seq mismatch: 0, Full state init pkt: 0, Invalid lsa: 0, Invalid external lsa: 0,
  Lsdb Absent: 0, Lsa lookup fail: 0, Ls req add fail: 0
LS request packet:
  Received packets: 0, Sent packets: 0, Total errors: 0, Invalid LSA type: 0
  Invalid state packet rcvd: 0, LSA lookup error: 0, LSA lookup fail: 0
  LSA obj add fail: 0, Misc: 0
LS update packet:
  Received packets: 0, Sent packets: 0, Total errors: 0, Invalid LSA type: 0
  Zero length LSA: 0, LSA length exceeded: 0, LSA checksum fail: 0
  Invalid state packet rcvd: 0, LSA obj add fail: 0, Invalid LSA payload: 0, Misc: 0
Ls ack packet:
  Received packets: 0, Sent packets: 0, Total errors: 0, LSA obj add fail: 0
  Invalid state packet rcvd: 0, Misc: 0
Sanity errors:
  Payload max len error: 0, Payload min len error: 0, Invalid version: 0
  Invalid auth data len: 0, Auth data missing: 0, Invalid packet min len: 0
  Invalid area ID: 0, Invalid network mask: 0, Authentication fail: 1
Instance: default, Address family: ipv6, Instance ID: 0
Interface: ifl-0/0/0/1, Peer address: fe80::7845:9aff:fec0:0
Hello packet:
  Received packets: 658, Sent packets: 658, Total errors: 0, Unsupported option: 0
  Area mismatch: 0, Area type option mismatch: 0, Dead interval mismatch: 0
  Hello interval mismatch: 0, Mask mismatch: 0, Self router ID: 0
  Obj add fail: 0, Source address mismatch: , Misc: 0
DD packet:
  Received packets: 4, Sent packets: 4, Total errors: 1, Unsupported option: 0
  Invalid state packet rcvd: 0, MTU mismatch: 0, DD obj add fail: 0, Misc: 0, Negotiation fail: 0
  Master bit mismatch: 0, Exchange state init pkt: 0, Capabilities mismatch: 0
  Expected seq mismatch: 0, Full state init pkt: 0, Invalid lsa: 0, Invalid external lsa: 0,
  Lsdb Absent: 0, Lsa lookup fail: 0, Ls req add fail: 0
LS request packet:
  Received packets: 1, Sent packets: 1, Total errors: 0, Invalid LSA type: 0
  Invalid state packet rcvd: 0, LSA lookup error: 0, LSA lookup fail: 0
  LSA obj add fail: 0, Misc: 0
LS update packet:
  Received packets: 4, Sent packets: 5, Total errors: 0, Invalid LSA type: 0
  Zero length LSA: 0, LSA length exceeded: 0, LSA checksum fail: 0
  Invalid state packet rcvd: 0, LSA obj add fail: 0, Invalid LSA payload: 0, Misc: 0
Ls ack packet:
  Received packets: 4, Sent packets: 4, Total errors: 0, LSA obj add fail: 0
  Invalid state packet rcvd: 0, Misc: 0
Sanity errors:
  Payload max len error: 0, Payload min len error: 0, Invalid version: 0
  Invalid auth data len: 0, Auth data missing: 0, Invalid packet min len: 0
  Invalid area ID: 0, Invalid network mask: 0, Authentication fail: 1
    
```

## OSPF Clear Commands

### Clear OSPF Neighbor

Clear OSPF neighbor state information.

Syntax:

**clear ospf neighbor** <options>

Option	Description
-	Without any option, the command clears all the OSPF neighbors.
instance <instance-name>	Clears OSPF neighbor information for the specified instance.
instance <instance-name> <afi>	Clears OSPF neighbor for the specified address family. Supported AFI values are 'ipv4' and 'ipv6'. Supported AFI values are 'ipv4' and 'ipv6'. When using an IPv6 address family with OSPFv3, an instance ID ranging from 0 to 31 must be specified.
instance <instance-name> <afi> area <area-id>	Clears OSPF neighbor for the specified area of the specified instance and address family.
instance <instance-name> <afi> area <area-id> interface <interface-name>	Clears OSPF neighbor for the specified interface for the specified area and address family of the specified instance.
force	Forcefully clears all the OSPF neighbors. This may impact DR/BDR election.
force instance <instance-name>	Forcefully clears the neighbor for the specified instance.
force instance <instance-name> <afi>	Forcefully clears OSPF neighbor for the specified address family.
force instance <instance-name> <afi> area <area-id>	Forcefully clears OSPF neighbor for the specified area of the specified instance and address family.
force instance <instance-name> <afi> area <area-id> interface <interface-name>	Forcefully clears OSPF neighbor for a specific interface and area of the specified instance and address family.

Example:

```
supervisor@rtbrick>SPINE01: cfg> clear ospf neighbor instance default ipv6 instance-id 0 area 0 interface
if1-0/0/0/1
Triggered clear neighbor successfully
```

## Clear OSPF Statistics

Clear the OSPF statistics for all instances or a specified instance.

Syntax:

**clear ospf statistics** <options>

Option	Description
-	Without any option, the command clears all the OSPF statistics.
instance <instance-name>	Clears OSPF statistics information for the specified instance.
instance <instance-name> <afi>	Clears OSPF statistics for the specified address family of the specified instance. Supported AFI values are 'ipv4' and 'ipv6'. When using an IPv6 address family with OSPFv3, an instance ID ranging from 0 to 31 must be specified.
instance <instance-name> <afi> area <area-id>	Clears OSPF statistics for the specified area of the specified instance and address family.
instance <instance-name> <afi> area <area-id> interface <interface-name>	Clears OSPF statistics for the specified interface for the specified area of the specified instance and address family.

Example:

```
supervisor@rtbrick>SPINE01: cfg> clear ospf statistics instance default ipv6 instance-id 0 area 0.0.0.0
interface if1-0/0/0/1
Cleared statistics for all ipv6 neighbors under Instance [default] Area [0.0.0.0] Interface [if1-0/0/0/1]
```

## Clear OSPF Database

Clear the OSPF database for all instances.

Syntax:

**clear ospf database** <options>

Option	Description
-	Without any option, the command clears all the OSPF database information.
<afi>	Clears OSPF database for the specified address family. Supported AFI values are 'ipv4' and 'ipv6'. Supported AFI values are 'ipv4' and 'ipv6'. When using an IPv6 address family with OSPFv3, an instance ID ranging from 0 to 31 must be specified.
<afi> instance <instance-name>	Clears OSPF database for the specified area of the specified instance and address family.

Example:

```
supervisor@rtbrick>SPINE01: cfg> clear ospf database ipv6 instance default instance-id 0
Triggered clear database successfully
```

## 2.8. LDP

### 2.8.1. LDP Overview

Label distribution protocol (LDP) is the most commonly used protocol in the MPLS network. It generates and distributes labels and thus helps in MPLS packet switching and forwarding. By using LDP, label-switching routers in an MPLS network can exchange label mapping information to create label-switched paths (LSPs) for switching data packets. RtBrick FullStack (RBFS) supports Dual-stack, which means LDP can exchange FEC-label bindings over either IPv4 or IPv6 networks.

#### Peer Discovery

LDP sends UDP multicast hello packets to discover its neighbors and establishes neighbor adjacency with other directly connected label switch routers (LSRs). The hello message is periodically sent on LDP-enabled interfaces.

## Session Establishment

After peer discovery, "initialization messages" are sent to each other. In these messages, the session Parameters are sent to each other. The LDP sessions are maintained by periodic keep-alive message.

After the LDP neighbors are discovered, the TCP session is established and the LDP FSM is triggered, and LDP session becomes operational. LSRs start exchanging label mapping information with each other.

## Dual-stack LDP

By default, RBFS is dual-stack capable, which means it can exchange IPv4/IPv6 FEC bindings over IPv4/IPv6 media (LDP over IPv4/IPv6).

To enable or disable a particular address family in RBFS, use "status <enable|disable>" CLI. For details, see [\[ldpug:ldp\\_overview:::ldp-address-family\]](#).

When LDP is enabled on an interface that supports both IPv4 and IPv6, LDP will start exchanging IPv4 hellos. To send an IPv6 hello, the source IPv6 address must be configured. For details about configuring the source address, see [\[ldpug:ldp\\_overview:::ldp-instance-config\]](#).

By default, both IPv4 and IPv6 hello will use the same transport preference as IPv6, but this can be changed by using the "connection-preference <ipv4|ipv6>" CLI. For details, see [\[ldpug:ldp\\_overview:::ldp-instance-config\]](#).

The following points should be noted regarding this functionality:

### Source address:

- Unless modified, IPv4 and IPv6 hellos will be sent with transport preference as IPv6 when the IPv6 source address is configured.
- When the IPv6 source address is not configured, only IPv4 hello will be sent with transport-preference IPv4 and still act as a dual-stack router and exchange both IPv4 and IPv6 FEC bindings.

### When IPv4 status is disabled:

- Only IPv6 hello will be sent without Dual-stack TLV.
- Only IPv6 FEC binding will be exchanged.



**When IPv6 status is disabled:**

- Only IPv4 hello will be sent without Dual-stack TLV.
- Only IPv4 FEC binding will be exchanged.

**When both IPv4 and IPv6 statuses are enabled:**

- Both IPv4 and IPv6 hellos will be exchanged (IPv6 source address configuration is mandatory for sending IPv6 hello).
- By default, the hello message uses IPv6 as the transport preference, unless otherwise specified.
- Both IPv4 and IPv6 FEC bindings will be exchanged.

**Label Generation**

LDP generates label bindings for the IP addresses of the LDP-enabled loopback interfaces and then advertises them to all neighbors.

**Label Management Modes****Label Advertisement Mode**

LDP supports the Downstream Unsolicited feature in RBFS, where label bindings are advertised to all upstream neighbors. By default, label advertisement operates in the Downstream Unsolicited mode.

**Label Distribution Control Mode**

LDP supports the Ordered Label Distribution Control, where an LSR will initiate the transmission of the label mapping only for the prefix for which it has a label mapping from the next hop of the prefix or for which it is an egress.

**Label Retention Mode**

LDP supports the Liberal Label Retention Mode where all the label mapping advertisements for all routes received from all the LDP neighbors are retained.

**Supported LDP Standards**

RFC Number	Description
RFC 5036	<p>LDP Specification</p> <p>The following modes are supported by RBFS for the features listed in RFC 5036:</p> <ul style="list-style-type: none"> <li>• Label advertisement: Downstream Unsolicited mode is supported but not Downstream on Demand mode.</li> <li>• Label distribution control: Ordered mode is supported, but not Independent mode.</li> <li>• Label retention: Liberal mode is supported, but not Conservative mode.</li> </ul>
RFC 5283	LDP Extension for Inter-Area Label Switched Paths (LSPs)
RFC 5443	LDP IGP Synchronization
RFC 7552	IPv6 Dual-Stack



RFC and draft compliance are partial except as specified.

## Supported LDP Features

The following LDP features are supported in this release of RBFS:

- Support for the following label management modes.
  - Downstream unsolicited mode in label advertisement
  - Ordered mode in the label distribution control
  - Liberal mode in label retention
- Loop detection
- Inter-area support
- Tracking IGP metric
- IGP LDP synchronization
- LDP Dual-stack support
- LDP TCP authentication
- LDP redistribution

- LDP policy configuration

## Supported Platforms

Not all features are necessarily supported on each hardware platform. Refer to the *Platform Guide* for the features and the sub-features that are or are not supported by each platform.

## 2.8.2. LDP Configuration

### LDP Configuration Hierarchy

The diagram below illustrates the LDP configuration hierarchy.

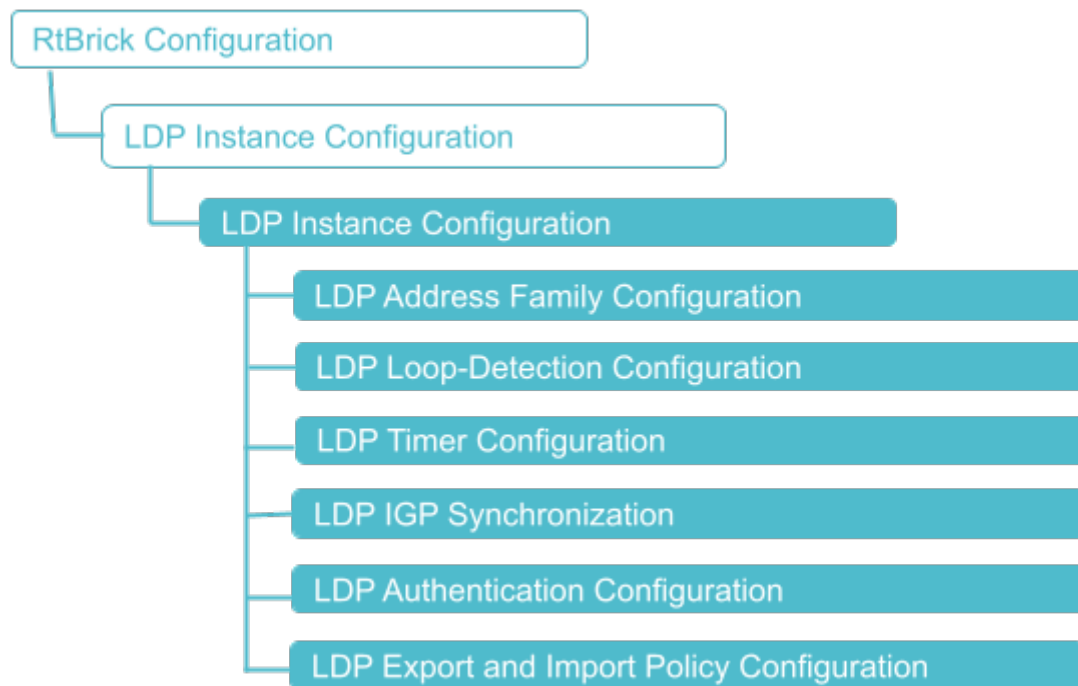

### Configuration Syntax and Commands

The following sections describe the LDP configuration syntax and commands.

#### LDP Instance Configuration

At this configuration hierarchy, you configure LDP protocol parameters which are generic to the LDP instance.

Syntax:

**set instance** <instance-name> **protocol ldp** <attribute> <value>

Attribute	Description
<instance-name>	Name of the LDP instance.
interface <name>	Name of the logical interface.
router-id <router-id>	Router identifier in IPv4 format.
address-family <afi>	Address family identifier (AFI). Supported values: ipv4, or ipv6. Refer to section <a href="#">2.8.2.2.2, “LDP Address Family Configuration”</a> for LDP address family configuration details.
connection-preference <afi>	Specifies the connection preference for the TCP session. Supported values: ipv4, or ipv6. By default, IPv6 is used as the preferred TCP connection if an IPv6 source address is configured. Refer to section <a href="#">[ldpug:ldp_config:::dual-stack-ldp]</a> for more information on the LDP Dual-stack behaviour.
igp-synchronization <...>	LDP IGP synchronization configuration. This option is supported only on interfaces running Intermediate System-to-System (IS-IS) or OSPFv2 processes. Refer to section <a href="#">2.8.2.2.5, “LDP IGP Synchronization”</a> for LDP-IGP synchronization configuration details.
source-address <ipv4 ipv6> <source-address>	Use the specified IP addresses (IPv4 or IPv6) as the transport address for the LDP session. For LDP over IPv6, the IPv6 source address is mandatory. Refer to section <a href="#">[ldpug:ldp_config:::dual-stack-ldp]</a> for more information on the LDP Dual-stack behavior.
loop-detection <...>	The LDP loop detection feature enables LDP to detect loops during an LSP establishment. Refer to section <a href="#">2.8.2.2.3, “LDP Loop Detection Configuration”</a> for the loop detection configuration details.
timer <...>	Specifies the Hello hold time, Hello interval, Keepalive hold time, and Keepalive interval. Refer to section <a href="#">2.8.2.2.4, “LDP Timer Configuration”</a> for the LDP timer configuration details.

Attribute	Description
peer <ipv4   ipv6> <address> authentication- id <...>	Specifies an IPv4 or IPv6 LDP peer attributes to apply TCP authentication. Refer to section <a href="#">2.8.2.2.6, "LDP Authentication Configuration"</a> .
peer <ipv4   ipv6> <address> export- policy   import-policy <...>	Specifies an IPv4 or IPv6 LDP peer attributes to apply import/export policy configurations. Refer to section <a href="#">2.8.2.2.7, "LDP Import and Export Policy Configuration"</a> .

### Example: LDP Instance Configuration

The following example shows some LDP instance configuration attributes. The further LDP configurations like timers and loop detection are shown in the examples in the subsequent sections.

```

supervisor@rtbrick>SPINE01: cfg> show config instance default protocol ldp
{
  "rtbrick-config:ldp": {
    "router-id": "198.51.100.1",
    "interface": [
      {
        "name": "ifl-0/0/0/1"
      },
      {
        "name": "ifl-0/0/0/100"
      },
      {
        "name": "ifl-0/0/0/101"
      },
      {
        "name": "ifl-0/0/1/102"
      },
      {
        "name": "ifl-0/0/2/1"
      },
      {
        "name": "ifl-0/0/3/1"
      },
      {
        "name": "lo-0/0/0/1"
      },
      {
        "name": "lo-0/0/0/2"
      },
      {
        "name": "lo-0/0/0/3"
      },
      {
        "name": "lo-0/0/0/4"
      },
      {

```

```

        "name": "10-0/0/0/5"
      }
    ]
  }
}
supervisor@rtbrick>SPINE01: cfg>
    
```

## LDP Address Family Configuration

The address-family command allows you to enable the address families that LDP will route and configure settings that are specific to that address family.

### Syntax:

**set instance** <instance-name> **protocol ldp address-family** <attribute> <value>

Attribute	Description
<afi>	Address family identifier (AFI). Supported values: ipv4, ipv6
<afi> status <enable   disable>	Enable or disable address family. By default, both IPv4 and IPv6 address families are enabled, as LDP supports dual stack. Refer to section <a href="#">[ldpug:ldp_config:::dual-stack-ldp]</a> for more information on the LDP Dual-stack behavior.
<afi> redistribute <source>	Specifies the source from which the routes are to be redistributed. The available options include <b>direct</b> , <b>ipoe</b> , <b>isis</b> , <b>ospf</b> , <b>ppp</b> , and <b>static</b> .
<afi> redistribute <source> policy <policy>	Specifies the name of the policy map. The redistribute attach point allows routes from other sources to be advertised by LDP. The policy can be applied only to the routes that are redistributed from other sources to LDP.

### Example 1: LDP Address Family Configuration

```

supervisor@rtbrick>SPINE01: cfg> show config instance default protocol ldp
address-family
{
  "rtbrick-config:address-family": [
    {
      "afi": "ipv6",
      "status": "disable"
    }
  ]
}
    
```

```

    ]
  }
supervisor@rtbrick>SPINE01: cfg>

```

## Example 2: LDP Redistribution Configuration

```

supervisor@rtbrick>SPINE01: cfg> show config instance default protocol ldp
address-family ipv4 redistribute direct
{
  "rtbrick-config:redistribute": [
    {
      "source": "direct"
    }
  ]
}
supervisor@rtbrick>SPINE01: cfg>

```

## Example 3: LDP Policy Configuration

```

supervisor@rtbrick>SPINE01: cfg> show config instance default protocol ldp
address-family ipv4 redistribute
{
  "rtbrick-config:redistribute": [
    {
      "source": "direct",
      "policy": "filter-link-addres"
    }
  ]
}
supervisor@rtbrick>SPINE01: cfg>

```

## LDP Loop Detection Configuration

The LDP loop detection feature enables LDP to detect loops during an LSP establishment.

### Syntax:

**set instance** <instance-name> **protocol ldp loop-detection** <attribute> <value>

Attribute	Description
hop-count <hop-count>	Specifies the hop count limit for loop detection. Range: 0-255. Default: 32.
status <enable   disable>	Enables or disables loop detection. By default, this option is disabled. When this option is enabled, both hop count and path vector are enabled.

Attribute	Description
vector-length <vector-length>	Specifies the path vector length limit for loop detection. Range: 0-255. Default: 32.

### Example 1: LDP Loop Detection Configuration

```

supervisor@rtbrick>SPINE01: cfg> show config instance default protocol ldp loop-
detection
{
  "rtbrick-config:loop-detection": {
    "enable": "true",
    "hop-count": 64,
    "vector-length": 64
  }
}
supervisor@rtbrick>SPINE01: cfg>

```

### LDP Timer Configuration

Specify the hello timer and hold-down timer for LDP adjacency. Similarly, specify the keepalive and keepalive timeout settings for the LDP session.

#### Syntax:

**set instance** <instance-name> **protocol ldp timer** <attribute> <value>

Attribute	Description
hello hold-time <hold-time>	Specifies the hello hold-time interval in seconds before declaring a neighbor to be down. Range: 0-65535. Default: 15.
hello interval <interval>	Specifies the hello messages interval in seconds. Range: 0-65535. Default: 5.
session keepalive-interval <keepalive-interval>	Specifies the session keepalive messages interval in seconds. Range: 1-65535. Default: 10.
session keepalive-timeout <keepalive-timeout>	Specifies the session keepalive timeout in seconds before declaring a session to be down. Range: 1-65535. Default: 30.

### Example 1: LDP Timer Configuration

```

supervisor@rtbrick>SPINE01: cfg> show config instance default protocol ldp timer

```



```

{
  "rtbrick-config:timer": {
    "hello": {
      "interval": 10,
      "hold-time": 20
    },
    "session": {
      "keepalive-interval": 3000,
      "keepalive-timeout": 5000
    }
  }
}
supervisor@rtbrick>SPINE01: cfg>

```

## LDP IGP Synchronization

Synchronization between LDP and the underlying interior gateway protocol (IGP) ensures that the LDP path is fully established before the IGP path is used for forwarding traffic. LDP IGP synchronization is supported only on interfaces running Intermediate System-to-System (IS-IS) or OSPFv2 processes.

### Syntax:

**set instance** <instance-name> **protocol ldp igp-synchronization** <attribute> <value>

Attribute	Description
hold-timer <hold-timer>	Specifies the hold-timer in seconds to limit how long the IGP session must wait before declaring the LDP synchronization. Range: 0-60. Default: 10.

### Example 1: LDP IGP Synchronization Configuration

```

supervisor@rtbrick>SPINE01: cfg> show config instance default protocol ldp igp-
synchronization
{
  "rtbrick-config:igp-synchronization": {
    hold-timer": 60,
  }
}
supervisor@rtbrick>SPINE01: cfg>

```

## LDP Authentication Configuration

To meet the security requirements of LDP sessions, configure LDP authentication.

**Syntax:**

**set instance** <instance-name> **protocol ldp peer ipv4|ipv6** <address>  
**authentication-id** <authentication-id>

Attribute	Description
<address>	Specifies the transport IP address of the peer.
<authentication-id>	Authentication Tuple Identifier

Example 1: LDP Authentication Configuration

```

supervisor@rtbrick>SPINE01: cfg> show config instance default protocol ldp peer
ipv4
{
  "rtbrick-config:ipv4": [
    {
      "address": "192.168.1.2",
      "authentication-id": "auth_id_1"
    }
  ]
}
supervisor@rtbrick>SPINE01: cfg>

```

**TCP Authentication Configuration**

In the instance TCP authentication hierarchy, you can optionally enable MD5 or HMAC-SHA-1-96, HMAC-SHA-256-128, or AES-128-CMAC-96 authentication. Authentication is not configured for LDP directly, but for the TCP sessions used by LDP.

Syntax:

**set instance** <instance> **tcp authentication** <authentication-id> <attribute>  
<value>

Attribute	Description
<authentication-id>	Authentication identifier
type <type>	Authentication identifier such as MD5 or HMAC-SHA-1-96,HMAC-SHA-256-128 or AES-128-CMAC-96
key1-id <key1-id>	Key ID1 of the receiver

Attribute	Description
key1-encrypted-text <key1-encrypted-text>	Encrypted text of key1
key1-plain-text <key1-plain-text>	Plain text of key1
key2-id <key2-id>	Key ID2 of the receiver
key2-encrypted-text <key2-encrypted-text>	Encrypted text of key2
key2-plain-text <key2-plain-text>	Plain text of key2

### Example: LDP TCP Authentication Configuration

```

supervisor@rtbrick>SPINE01: cfg> show config instance default tcp authentication
auth_id_1
{
  "rtbrick-config:authentication": [
    {
      "authentication-id": "auth_id_1",
      "type": "MD5",
      "key1-id": 1,
      "key1-encrypted-text": "$2a6fd7db50a18a9f1f16b5c5b4214fab0"
    }
  ]
}
supervisor@rtbrick>SPINE01: cfg>
    
```

### LDP Import and Export Policy Configuration

#### Syntax:

**set instance** <instance-name> **protocol ldp peer ipv4|ipv6** <address>  
<attribute> <value>

Attribute	Description
<address>	Specifies the IPv4 or IPv6 address.
export-policy <export-policy>	Export policy identifier
import-policy <import-policy>	Import policy identifier

## Example 1: LDP Export Configuration

```

supervisor@rtbrick>SPINE01: cfg> show config instance default protocol ldp peer
ipv4
{
  "rtbrick-config:ipv4": [
    {
      "address": "192.168.1.2",
      "export-policy": "exp-policy1"
    }
  ]
}
supervisor@rtbrick>SPINE01: cfg>

```

## Example 3: LDP Import Configuration

```

supervisor@rtbrick>SPINE01: cfg> show config instance default protocol ldp peer
ipv4
{
  "rtbrick-config:ipv4": [
    {
      "address": "192.168.1.2",
      "import-policy": "imp-policy1"
    }
  ]
}
supervisor@rtbrick>SPINE01: cfg>

```

## 2.8.3. LDP Operational Commands

### LDP Show Commands

The LDP show commands provide detailed information about the LDP protocol operations.

### LDP Summary

#### Syntax:

**show ldp summary** <options>

Option	Description
-	Without any option, the command displays the LDP summary information for all instances.

Option	Description
instance <instance-name>	Displays LDP summary information about the specified instance.

### Example: LDP summary for the default instance

```

supervisor@rtbrick>SPINE01: op> show ldp summary
Instance: default
  General information:
    LDP identifier: 198.51.100.1:0, Version: 1
    FEC resolution: Best match
    Protocol preference: 9
    LSR ID: 198.51.100.1
    IPv4 Status: True
    IPv6 Status: True
  Modes:
    Advertisement mode: Downstream Unsolicited
    Advertisement control mode: Ordered
    Label retention mode: Liberal
  Capabilities:
    IPv6 address family: - , Graceful restart: False
    Loop detection: False
    Hop count: -, Vector length: -
  Timers:
    Adjacency:
      Hello: 5s, Holdtime: 15s
    Targeted adjacency:
      Hello: 15s, Holdtime: 45s
    Session:
      Keepalive: 10s, Holdtime: 30s
  Statistics:
    Adjacency:
      Link adjacency: 5, Targeted adjacency: 0
    Session:
      Session in non-existent: 0, Session in initialized: 0
      Session in opensent: 0, Session in openconfirm: 0
      Session in operational: 2
supervisor@rtbrick>SPINE01: op>
    
```

## LDP Neighbor

### Syntax:

**show ldp neighbor** <options>

Option	Description
-	Without any option, this command displays information about LDP neighbors.
detail	Detailed information about the LDP neighbors.

Option	Description
instance <instance-name>	Displays LDP neighbor information about the specified instance.
instance <instance-name> detail	Displays detailed LDP neighbor information about the specified instance.
instance <instance-name> ldp-id <ldp-id>	Displays LDP neighbor information about the specified LDP identifier and instance.
interface <name>	Displays LDP neighbor information about the specified interface.
interface <name> detail	Displays detailed LDP neighbor information about the specified interface.
ldp-id <ldp-id>	Displays LDP neighbor information about the specified LDP identifier.

### Example 1: Summary view of LDP Neighbor

```

supervisor@rtbrick>SPINE01: op> show ldp neighbor
Instance: default
  Interface          LDP ID          Transport IP    Up Since
Expires
  if1-0/0/0/1       198.51.100.2:0  198.51.100.2   Thu Feb 09 12:17:15   in
11s
  if1-0/0/2/1       198.51.100.3:0  198.51.100.3   Thu Feb 09 12:17:31   in
12s
  if1-0/0/0/100     198.51.100.2:0  198.51.100.2   Thu Feb 09 12:17:15   in
11s
  if1-0/0/0/101     198.51.100.2:0  198.51.100.2   Thu Feb 09 12:17:15   in
11s
  if1-0/0/1/102     198.51.100.2:0  198.51.100.2   Thu Feb 09 12:17:15   in
11s
supervisor@rtbrick>SPINE01: op>

```

### Example 2: Detailed View of LDP Neighbor

```

supervisor@rtbrick>SPINE01: op> show ldp neighbor detail
Instance: default
  LDP-Identifier: 198.51.100.2:0, Interface: if1-0/0/0/1, Type: Link
  Negotiated holdtime: 15000, Expiry time: 13s 183407us
  Local link address: 192.0.2.1, Peer link address: 192.0.2.2
  Local transport address: 198.51.100.1:0, Peer transport address: 198.51.100.2
  Local holdtime: 15, Peer holdtime: 15, Up since: Tue May 02 13:28:17
  Local transport preference : ipv4, Peer transport preference : ipv4
  Last transition time: Tue May 02 13:38:52 GMT +0000 2023
<...>

```

## LDP Interface

### Syntax:

**show ldp interface** <option>

Option	Description
-	Without any option, this command displays information on all configured LDP interfaces.
<interface-name>	Specify the name of the interface.
detail	Detailed interface information.

### Example 1: Specified LDP interface details

```

supervisor@rtbrick: cfg> show ldp interface if1-0/0/1/1
Instance: green
  Interface: if1-0/0/1/1
    Primary IPv4 Address: 12.1.0.1, Primary IPv6 Address: fe80::783f:e5ff:fec0:1
    Session Hold: 30, Session Keepalive: 10
    Discovery Hello: 5, Discovery Hold: 15
    Neighbor count: 1, Transport preference: ipv4
    IPv4 enable: True, IPv6 enable: True, Cisco interop: False
    
```

### Example 2: View of LDP interfaces

```

supervisor@rtbrick: cfg> show ldp interface
Instance: default
  Interface           Primary IPv4 Address      Primary IPv6 Address
  if1-0/0/0/1         12.0.0.1                  fe80::783f:e5ff:fec0:0
  if1-0/0/0/100       12.0.1.1                  fe80::65:783f:e5ff:fec0:0
  if1-0/0/0/101       12.0.2.1                  fe80::66:783f:e5ff:fec0:0
  if1-0/0/1/102       12.0.3.1                  fe80::67:783f:e5ff:fec0:1
  if1-0/0/2/1         13.0.0.1                  fe80::783f:e5ff:fec0:2
  if1-0/0/3/1         14.0.0.1                  fe80::783f:e5ff:fec0:3
  lo-0/0/0/1          192.168.0.1
  lo-0/0/0/2          192.168.1.1
  lo-0/0/0/3          192.168.2.1
  lo-0/0/0/4          192.168.3.1
  lo-0/0/0/5          192.168.4.1
Instance: green
  Interface           Primary IPv4 Address      Primary IPv6 Address
  if1-0/0/0/202       12.1.3.1                  fe80::cb:783f:e5ff:fec0:0
  if1-0/0/1/1         12.1.0.1                  fe80::783f:e5ff:fec0:1
  if1-0/0/1/200       12.1.1.1                  fe80::c9:783f:e5ff:fec0:1
  if1-0/0/1/201       12.1.2.1                  fe80::ca:783f:e5ff:fec0:1
  if1-0/0/2/200       13.1.0.1                  fe80::c9:783f:e5ff:fec0:2
  if1-0/0/3/200       14.1.0.1                  fe80::c9:783f:e5ff:fec0:3
  lo-0/0/1/1          172.168.0.1
  lo-0/0/1/2          172.168.1.1
  lo-0/0/1/3          172.168.2.1
    
```

```

lo-0/0/1/4          172.168.3.1
lo-0/0/1/5          172.168.4.1
    
```

## LDP Session

### Syntax:

**show ldp session** <options>

Option	Description
-	Without any option, this command displays a summary of LDP session information.
detail	Displays detailed information about the LDP sessions.
instance <instance-name>	Displays LDP session information about the specified instance.
instance <instance-name> detail	Displays detailed LDP session information about the specified instance.
instance <instance-name> ldp-id <ldp-id>	Displays LDP session information about the specified LDP identifier and instance.
ldp-id <ldp-id>	Displays LDP session information about the specified LDP identifier.

### Example 1: Summary view of LDP Session

```

supervisor@rtbrick>SPINE01: op> show ldp session
Instance: default
  LDP ID          Peer IP          State          Up/Down          FECRcvd  FECSent
  198.51.100.2:0  198.51.100.2    Operational    0d:00h:29m:44s   15       15
  198.51.100.3:0  198.51.100.3    Operational    0d:00h:29m:29s   15       15
supervisor@rtbrick>SPINE01: op>
    
```

### Example 2: Detailed View of LDP Session

```

supervisor@rtbrick>SPINE01: op> show ldp session detail
Instance: default
  LDP Identifier: 198.51.100.2:0, Peer IP: 198.51.100.2, Local IP: 198.51.100.1
  Type: link, State: Operational, Uptime: 0d:00h:34m:35s
  Reason:
  Last transition: Thu Feb 09 12:17:28 GMT +0000 2023, Flap count: 0
  Advertisement Mode:
  Peer: Downstream unsolicited, Local: Downstream unsolicited
  Negotiated: Downstream unsolicited
  Timers:
  Connect retry: 10s
    
```



```

Peer keepalive interval: 10s, Local keepalive interval: 10s
Peer keepalive timeout: 30s, Local keepalive timeout: 30s
Negotiated keepalive interval: 10s
Negotiated keepalive timeout: 30s
Received messages:
  Initialization: 1, KeepAlive: 208, Notification: 0
  Address: 1, Address Withdraw: 0, Label Mapping: 15
  Label Withdraw: 0, Label Release: 0
Sent messages:
  Initialization: 1, KeepAlive: 208, Notification: 0
  Address: 1, Address Withdraw: 0, Label Mapping: 15
  Label Withdraw: 0, Label Release: 0
Capability:
  Typed WildCard FEC:
  Local Support: True, Peer Support: True, Negotiated: True
Total received messages:
  Initialization: 1, KeepAlive: 92, Notification: 0
  Address: 2, Address Withdraw: 0, Label Mapping: 20
Total sent messages:
  Initialization: 1, KeepAlive: 92, Notification: 0
  Address: 2, Address Withdraw: 0, Label Mapping: 20
  Label Withdraw: 0, Label Release: 0
<...>
    
```

## LDP Address

### Syntax:

**show ldp address** <options>

Option	Description
-	Without any option, this command displays a summary of all the interface addresses received from the LDP sessions.
instance <instance-name>	Displays LDP address information about the specified instance.
instance <instance-name> <afi>	Displays LDP address of the specified address family (AFI). Supported values: ipv4, ipv6.
instance <instance-name> ldp-id <ldp-id>	Displays LDP address information about the specified LDP identifier and instance.
ldp-id <ldp-id>	Displays LDP address information about the specified LDP identifier.

### Example: Summary View of LDP Address

```

supervisor@rtbrick>SPINE01: op> show ldp address
    
```

```
Instance: default, LDP Identifier: 198.51.100.2:0, AFI: ipv4
 198.51.100.61
 198.51.100.102
 198.51.100.63
 198.51.100.94
 198.51.100.2
 198.51.100.65
 198.51.100.222
 198.51.100.21
 198.51.100.2145
 198.51.100.48
<...>
```

## LDP Binding

### Syntax:

**show ldp binding** <options>

Option	Description
-	Without any option, this command displays a summary of all the LDP label bindings.
instance <instance-name>	Displays LDP label binding information about the specified instance.
instance <instance-name> prefix <ip>	Displays LDP label binding information about the specified prefix and instance. Supported prefix values: ipv4, ipv6.
prefix <ip>	Displays the LDP label binding information for the specified prefix. Supported prefix values: ipv4, ipv6.
received	Displays the LDP received label binding information of the LDP sessions.
received instance <instance-name>	Displays LDP received label binding information of the specified instance.
received instance <instance-name> ldp-id <ldp-id>	Displays LDP received label binding information about the specified LDP identifier and instance.
received ldp-id <ldp-id>	Displays LDP received label binding information of the specified LDP identifier.
sent	Displays the LDP sent label binding information of the LDP sessions.

Option	Description
sent instance <instance-name>	Displays LDP sent label binding information of the specified instance.
sent instance <instance-name> ldp-id <ldp-id>	Displays LDP sent label binding information about the specified LDP identifier and instance.
sent ldp-id <ldp-id>	Displays LDP sent label binding information of the specified LDP identifier.

### Example 1: Summary view of LDP Binding

```

supervisor@rtbrick>SPINE01: op> show ldp binding

Instance: default, AFI: ipv4
  Prefix          In Label          Out Label          LDP ID
Status
  198.51.100.1/32  -                 label:3            -
Best
Non-best          label:20066       -                 198.51.100.3:0
Non-best          label:20065       -                 198.51.100.2:0
  198.51.100.11/32 -                 label:3            -
Best
Non-best          label:20066       -                 198.51.100.3:0
Non-best          label:20065       -                 198.51.100.2:0
  198.51.100.41/32 -                 label:3            -
Best
Non-best          label:20066       -                 198.51.100.3:0
Non-best          label:20065       -                 198.51.100.2:0
  198.51.100.44/32 -                 label:3            -
Best
Non-best          label:20066       -                 198.51.100.3:0
Non-best          label:20065       -                 198.51.100.2:0
  198.51.100.47/32 -                 label:3            -
Best
Non-best          label:20066       -                 198.51.100.3:0
Non-best          label:20065       -                 198.51.100.2:0
  198.51.100.2/32  label:3           label:20065       198.51.100.2:0
Best
Non-best          label:20065       -                 198.51.100.3:0
  198.51.100.21/32 label:3           label:20065       198.51.100.2:0
Best
Non-best          label:20065       -                 198.51.100.3:0
    
```

```

198.51.100.42/32      label:3      label:20065      198.51.100.2:0
Best
Non-best
<...>
label:20065      -      198.51.100.3:0

```

**Example 2: Summary view of LDP Binding for the specified prefix**

```

supervisor@rtbrick>SPINE01: op> show ldp binding prefix 198.51.100.2/32
Instance: default, AFI: ipv4
  Prefix          In Label      Out Label      LDP ID
Status
  198.51.100.2/32  label:3       label:20065    198.51.100.2:0
Best
Non-best
label:20065      -      198.51.100.3:0
supervisor@rtbrick>SPINE01: op>

```

**LDP Route**

**Syntax:**

**show ldp route** <options>

Option	Description
-	Without any option, this command displays a summary of LDP route information.
instance <instance-name>	Displays LDP route information for the specified instance.
instance <instance-name> <afi>	Displays LDP route information for the specified address family and instance. Supported AFI values: ipv4, ipv6, and mpls.
instance <instance-name> ipv4 prefix <ip>	Displays LDP route information for the specified address family of IPv4 prefix and instance.
instance <instance-name> ipv6 prefix <ip>	Displays LDP route information for the specified address family of IPv6 prefix and instance.
instance <instance-name> prefix <ip>	Displays LDP route information for the specified prefix and instance.
instance <instance-name> label <label>	Displays LDP route information for the specified MPLS label and instance.

Option	Description
instance <instance-name> mpls	Displays LDP route information about MPLS labels.
instance <instance-name> mpls label <label>	Displays LDP route information for the specified MPLS label and instance.
label <label>	Displays LDP route information for the specified MPLS label.
ipv4	Displays LDP route information about the IPv4 address family.
ipv4 prefix <ip>	Displays LDP route IPv4 address family information for the specified prefix.
ipv6	Displays LDP route information about the IPv6 address family.
ipv6 prefix <ip>	Displays LDP route IPv6 address family information for the specified prefix.
mpls	Displays LDP route information about MPLS labels.
mpls label <label>	Displays LDP route information for the specified MPLS label.
prefix <ip>	Displays LDP route information for the specified prefix address.

### Example: Summary view of LDP Route

```

supervisor@rtbrick>SPINE01: op> show ldp route
Instance: default, AFI: ipv4, SAFI: labeled-unicast
  Prefix/Label      Advertised label  Received label   Next Hop
Interface          Metric
  198.51.100.1/32   3                -                -
-
  198.51.100.2/32   20065            -                198.51.100.61
ifl-0/0/0/1        1000000
  198.51.100.3/32   20067            20067            198.51.100.61
ifl-0/0/0/1        2000001
  198.51.100.11/32  3                -                -
-
  198.51.100.21/32  20065            -                198.51.100.61
ifl-0/0/0/1        1000000
  198.51.100.31/32  20067            20067            198.51.100.61
ifl-0/0/0/1        2000001
  198.51.100.41/32  3                -                -
-
  198.51.100.42/32  20065            -                198.51.100.61
ifl-0/0/0/1        1000000
    
```

```

198.51.100.43/32      20067      20067      198.51.100.61
ifl-0/0/0/1        2000001
198.51.100.44/32      3          -          -          -
-
198.51.100.45/32      20065      -          198.51.100.61
ifl-0/0/0/1        1000000
198.51.100.46/32      20067      20067      198.51.100.61
ifl-0/0/0/1        2000001
198.51.100.47/32      3          -          -          -
-
198.51.100.48/32      20065      -          198.51.100.61
ifl-0/0/0/1        1000000
198.51.100.49/32      20067      20067      198.51.100.61
ifl-0/0/0/1        2000001
<...>

```

## LDP Statistics

### Syntax:

**show ldp statistics** <options>

Option	Description
-	Without any option, the command displays the LDP statistics for all instances.
instance <instance-name>	Displays LDP statistics information about the specified instance.
instance <instance-name> ldp-id <ldp-id>	Displays LDP statistics information about the specified LDP identifier and instance.

### Example: LDP statistics information

```

supervisor@rtbrick>SPINE01: op> show ldp statistics
Instance: default, LDP ID: 198.51.100.2:0
  Received messages:
    Initialization: 1, KeepAlive: 558, Notification: 0
    Address: 1, Address Withdraw: 0, Label Mapping: 15
    Label Withdraw: 0, Label Release: 0
  Sent messages:
    Initialization: 1, KeepAlive: 558, Notification: 0
    Address: 1, Address Withdraw: 0, Label Mapping: 15
    Label Withdraw: 0, Label Release: 0
Instance: default, LDP ID: 198.51.100.3:0
  Received messages:
    Initialization: 1, KeepAlive: 557, Notification: 0
    Address: 1, Address Withdraw: 0, Label Mapping: 15
    Label Withdraw: 0, Label Release: 0
  Sent messages:
    Initialization: 1, KeepAlive: 557, Notification: 0
    Address: 1, Address Withdraw: 0, Label Mapping: 15

```

```
Label Withdraw: 0, Label Release: 0
supervisor@rtbrick>SPINE01: op>
```

## LDP TCP connection

### Syntax:

**show ldp tcp connection** <options>

Option	Description
-	Without any option, the command displays the TCP connections used by LDP for all instances.
detail	Detailed list view of the TCP connections.
detail instance <instance-name>	Detailed list view of the TCP connections of the specified instance.
instance <instance-name>	TCP connections summary of the specified instance.

Example: Summary view of the LDP TCP connections

```
supervisor@rtbrick>SPINE01: op> show ldp tcp connection
Instance      Local IP      Remote IP      Local port      Remote
port  State
default       198.51.100.1  198.51.100.2  646
64718  Established
default       198.51.100.1  198.51.100.3  646
64718  Established
supervisor@rtbrick>SPINE01: op>
```

## LDP Clear Commands

Clear commands allow resetting operational states.

### Clear LDP Session

#### Syntax:

**clear ldp session** <options>

Option	Description
all	Clears all the LDP sessions.

Option	Description
all soft-in	Sends route refresh to all neighbors to receive FEC bindings.
all soft-out	Re-advertises all the routes previously sent to the peers.
instance <instance-name> all	Clears all the LDP sessions for the specified instance.
instance <instance> all soft-in	Sends route refresh to all neighbors to receive FEC bindings for the specified instance.
instance <instance> all soft-out	Re-advertises all the routes previously sent to the peers for the specified instance.
instance <instance-name> peer ldp-id <ldp-id>	Clears the LDP session for the specified instance and peer LDP identifier.
instance <instance> peer ldp-id <ldp-id> soft-in	Sends route refresh to the specific peer to receive FEC bindings for the specified instance and peer ldp-id.
instance <instance> peer ldp-id <ldp-id> soft-out	Re-advertises all the routes previously sent to the specific peer for the specified instance and peer ldp-id.

Example: The example below shows how to clear all the LDP sessions.

```
supervisor@rtbrick>SPINE01: op> clear ldp session all
LDP session cleared with instance default
supervisor@rtbrick>SPINE01: op>
```

## Clear LDP Statistics

### Syntax:

**clear ldp statistics** <options>

Option	Description
all	Clears all the LDP statistics.
instance <instance-name> all	Clears all the LDP statistics for the specified instance.



Option	Description
instance <instance-name> peer ldp-id <ldp-id>	Clears the LDP statistics for the specified instance and peer LDP identifier.

Example: The example below shows how to clear all the LDP statistics.

```
supervisor@rtbrick>SPINE01: op> clear ldp statistics all
LDP statistics cleared for instance default
supervisor@rtbrick>SPINE01: op>
```

## Clear LDP Neighbor

### Syntax:

**clear ldp neighbor** <options>

Option	Description
all	Clears all the LDP neighbors.
instance <instance-name>	Clears the LDP neighbor for the specified instance.

Example: The example below shows how to clear all the LDP neighbor.

```
supervisor@rtbrick>SPINE01: op> clear ldp neighbor all
LDP neighbor cleared with instance default
supervisor@rtbrick>SPINE01: op>
```

## 2.9. Policy

### 2.9.1. Policy Overview

Policies are rules that allow to control and modify the behavior of routing protocols such as BGP, IS-IS, OSPF, and other supported protocols. The policy framework is generic; it serves multiple purposes and applications. Policies are first created using a common policy configuration and then applied by attaching them to an application like a protocol.

The following diagram shows policy configuration options.



## Policy Components

In RtBrick Full Stack, the policy implementation consists of 4 sub-components:

- Policy Repository
- Command Processing Module
- Policy Server, the policy generation and relationship management component
- Policy Client, the policy enforcement component

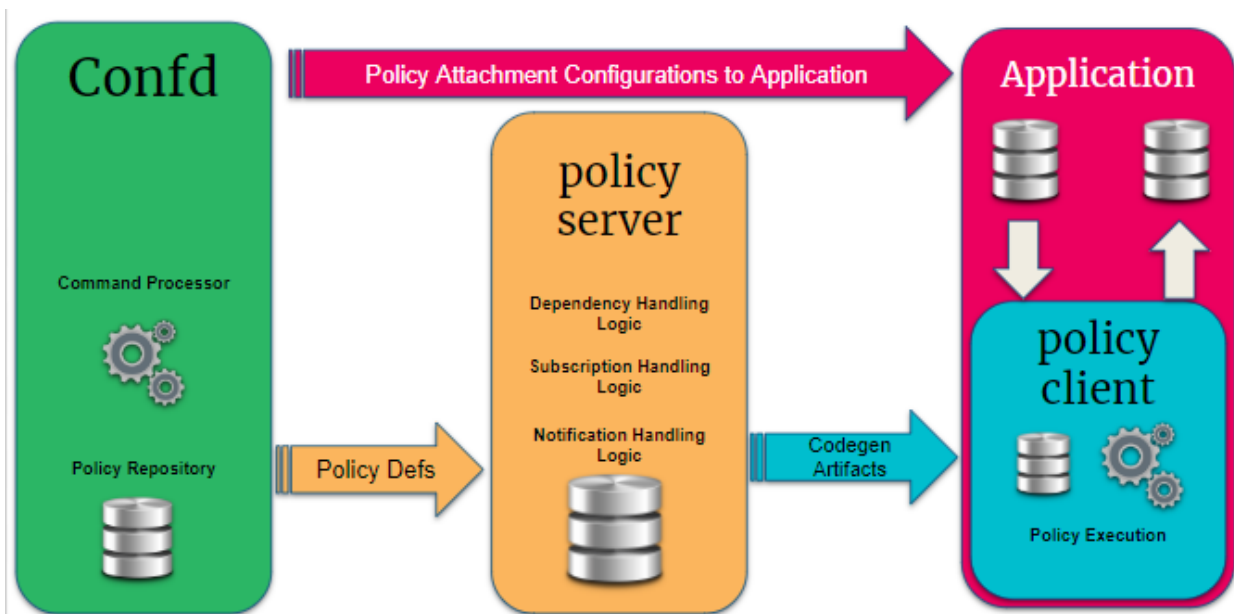

### Policy Repository

The policy repository contains all tables related to policy and the associated list of match criteria.

### Command Processing Module

The command processing module is part of the configuration daemon (confd), and it handles user interaction with the policy module. This is the back-end of the Command Line Interface (CLI) and JSON configuration that supports the policy

configurations.

This module maps the user-defined configuration into the back-end policy object, which is used by the execution engine (after verification), and it ensures that the policy can be correctly executed. This module relays the user intent via related BDS tables to the policy server.

## **Policy Server**

The policy server is a server component that manages all policy rules in the various policy tables and also code generation of the policies.

The following are the functionalities of the policy server:

- Parses the objects in the policy tables and is an execution engine that generates the code to build the policy rules for evaluation, the relationship between various objects, and relays the intent to the evaluation engine.
- Maintains relationships between various policy constructs such as policy statements, rules, ordinals, and lists.
- Tracks the attachment points so that when policies are modified, the appropriate clients are notified of the relevant new policies.
- Flattens the various relationships and generates a notification table that the clients subscribe to obtain notifications based on specific interest groups.
- Uses dependency table relationships to generate jobs to trigger code generation for various policy components.
- On code generation, the policy server updates a notification table that maintains the mapping between the policy server and the client interest groups. The notification table is a single point for the dissemination of information so that it can generate notifications for clients depending on their subscriptions for policy of interest.
- Policy server notification is generated for the policy clients. A notification is received from the notification table with metadata information that notifies the client if this is a new version of the policy or the original version of the policy. The client uses this information to enforce the policy evaluation and to decide on the version of the policy rule that should be used.

## Policy Client

The policy client is a shared library component to which a client daemon, like BGP, IS-IS, OSPF, etc., links. This is the component that performs policy enforcement. It performs the following tasks:

- Links with client daemons like BGP, IS-IS, and OSPF.
- Contains a listener that gets notifications on the availability of a new policy rule that is generated by the policy server.
- Evaluates the compiled rule, and if there are any listeners/ interests, then notifies the components within the client daemon.
- Evaluates any policy configurations on the client daemon and invokes policy processing in response.

## Tables and Subscriptions

The table below shows the various tables and their sharing across various policy components.

Confd	global.policy.list.config global.policy.list.entry.config global.policy.match.rules.config global.policy.statement.config global.policy.ordinal.config global.policy.mapping.list global.policy.mapping.rules	Policy Statement is composed of one or more policy terms. Each term has a match action criteria. In the match and action criteria, either a single element or a list of elements are compared, and actions are taken. The actions include accept, deny, flow-control, etc.
policy.server	global.policy.dependency global.<bds_name>.policy.subscription global.<bds_name>.policy.notification	Policy Server subscribes to all the tables from <b>confd</b> and creates tables that track policy-entry and dependency and notifies clients after code generation.

policy.client	global.<bds_name>.policy.shared.object.cache global.<bds_name>.policy.subscription global.<bds_name>.policy.context	Subscribes to code generation notifications application context and maintains cache of subscribed .so
---------------	---	---

## Policy Building Blocks

The figure below shows the building blocks of a policy.

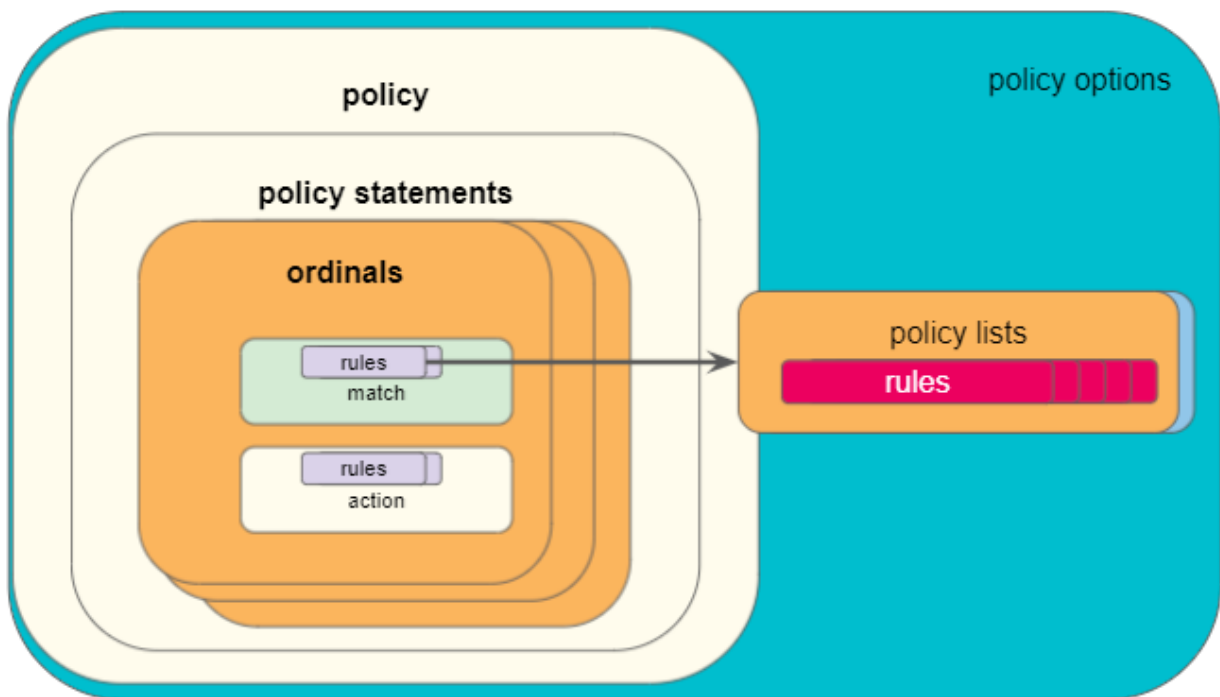

### Statements

A policy is defined by a policy statement. A policy statement is a compound block of policy definition that consists of one or more set of rules called ordinals. A policy statement is exercised in the order defined. The statement name is a globally unique string that is used to identify the policy, and used by the applications.

The following diagram shows policy statement configuration parameters.

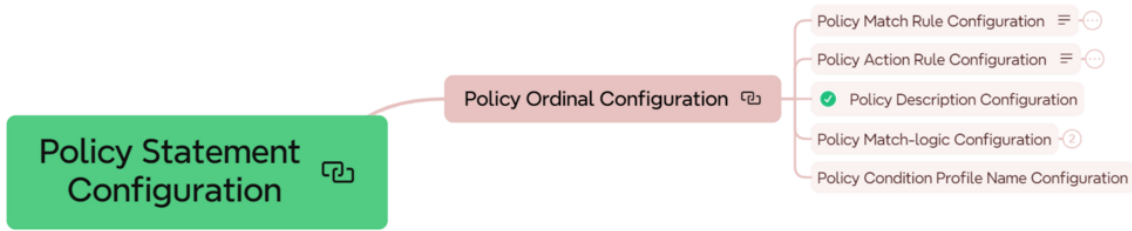

## Ordinals

A policy ordinal is the smallest block to represent a user policy intent and consists of rules for match and action blocks. The match blocks can either define single independent elements like AS path, IP prefix, IP addresses, community, and so on, or a list of the elements maintained in a different table.

- An ordinal must be a unique number within the scope of a statement which determines the order of the term execution within a policy statement.
- If no ordinal exist or configured, and if the policy is used, then all routes or objects will be denied.
- A match logic is defined per ordinal. In case of multiple match rules, it defines if all rules (**and**), or any of the rules (**or**) have to match.

## Match Rules

Match rules define criteria to evaluate and select routes or other objects to which the policy is applied. One or more match rules compose a match block.

The following diagram shows policy match rule parameters.



- If the match block results in a successful match ("true"), the corresponding action block will executed.

- If the match block result is unsuccessful ("false"), the action block will not be executed, and the next ordinal will be processed.
- If there is no match block, the action block will be executed.

In case of multiple match rules, the behaviour depends on the configured match logic:

- If the match logic is **or**, the match block result will be successful ("true") if any one rule matches. Otherwise, by default it is "false".
- If the match logic is **and**, the match block result will be successful ("true") if all rules match. Otherwise it is "false".

A match rule can refer to a single **discrete** value, or a list. A policy list is configured separately and referenced from the policy statement. In case of a list match, the behaviour is as follows:

- If any of the list entries matches the configured value, the match block result will be successful ("true"). Otherwise it is "false".
- If the list is defined but empty, the match rule result will be unsuccessful ("false").

## Action Rules

Action rules define operations like **return-permit** or **return-deny**, or flow control commands like **goto-next-ordinal**. The action block will be executed if there is a successful match. Otherwise, the next ordinal is processed. The action block can contain one or multiple action rules. In case of multiple action rules, all actions will be applied. The rules are executed in the order of the rule numbers. If there is any termination action, the rules afterwards are not executed anymore.

The action block is optional. The implicit default action is **return-deny**.

The following diagram shows action rules configuration parameters.



## Lists

A policy list is a list of values that can be referenced by a match rule in a policy statement. If you have a number of values like for example route prefixes, it is more efficient to refer to a policy list instead of creating one match rule per prefix.

Policy lists are configured separately and can thereby be maintained more easily. Besides, policy lists can be referenced by multiple policy statements.

## Conditions

Policy conditions are configured separately and can be used as an additional option in policy statements. A policy rule (ordinal) will only be executed if the condition is true. Conditional policies allow to make policy execution depended on certain states of the system, for example:

- Protocol neighbor states
- Presence or absence of a specific route and/or path attribute
- Number of routes in a routing table

One condition is supported per ordinal. A single condition can be attached to multiple policies.

## Attachment Points

Policies define a set of rules that can be used for various purposes by various applications. Once policies have been created, they need to be applied to take effect. Attachment points describe the specific applications and processes to which policies can be applied.

The following diagram shows the BGP attachment points.





RBFS currently supports the following policy attachment points:

- Instance import/export - Policies attached to an instance at the address family level allow to control which routes will be imported into the instance and exported from the instance by BGP. Such import and export policies are commonly used with BGP L3VPNs.

The following diagram shows the BGP Global Instance attachment points.

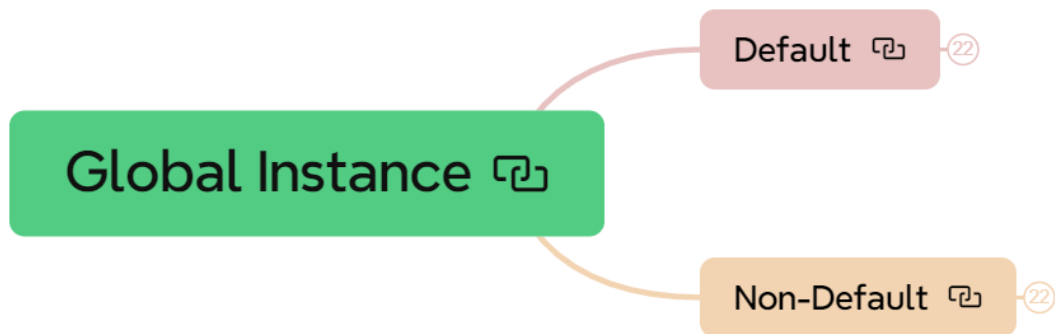

The following diagram shows the BGP Global Instance default attachment points.

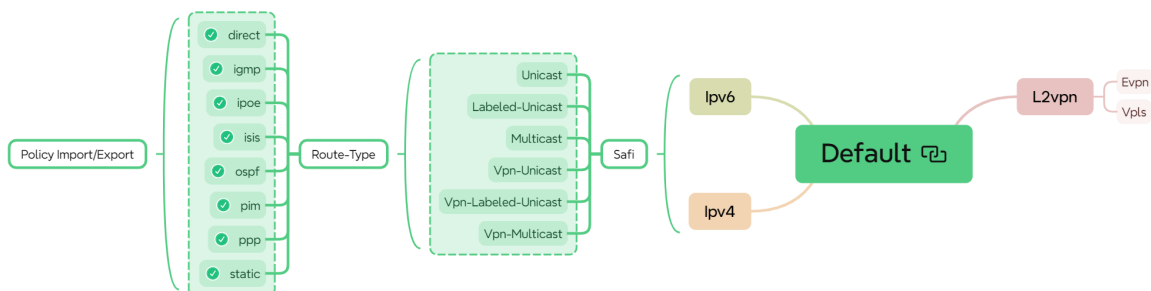

The following diagram shows the BGP Global Instance non-default attachment

points.

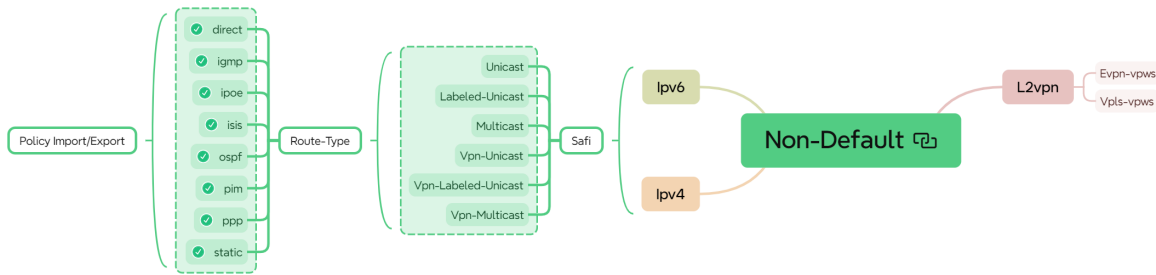

- BGP peer group import/export - Policies attached to BGP peer groups allow to define which routes will be advertised to and accepted from BGP peers. You can attach policies to both instances or peer groups to define the import and export behavior. You can also combine both attachment points, for example if some policy rules apply generically to the instance and some other rules specifically to a peer or peer group.

The following diagram shows BGP peer group attachment points.

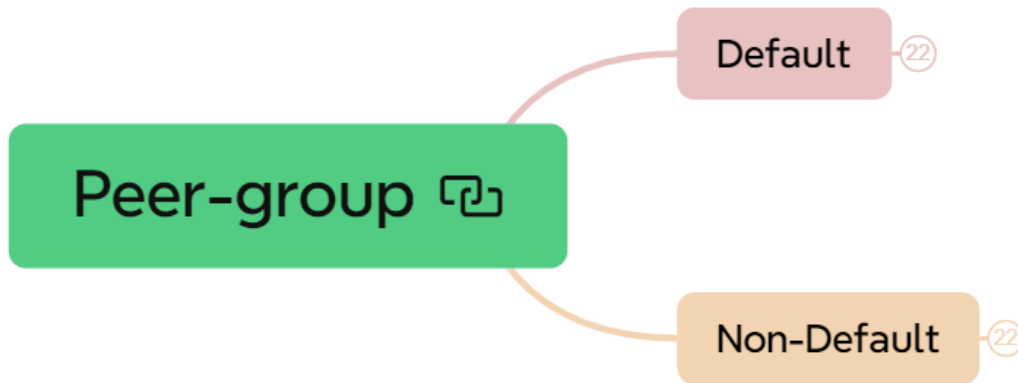

The following diagram shows BGP peer group default attachment points.

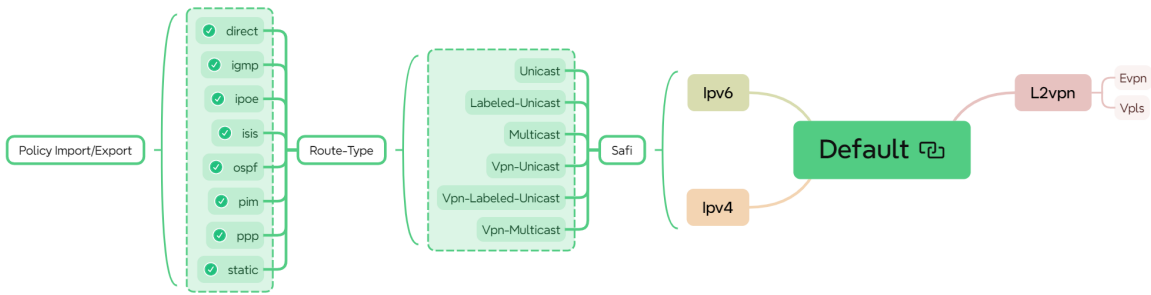

The following diagram shows BGP peer group non-default attachment points.

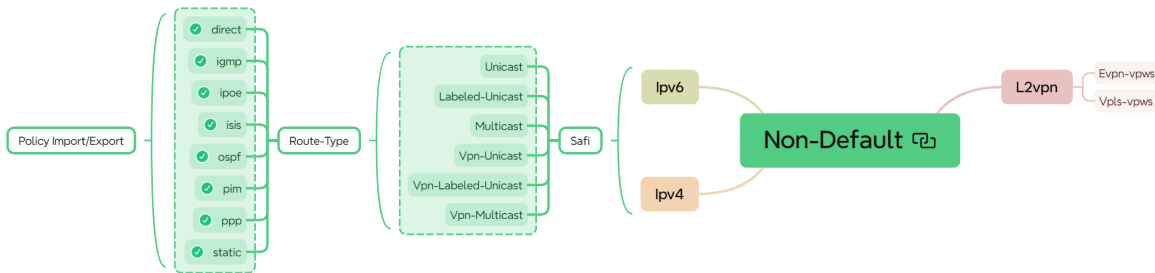

- BGP redistribution - You can attach policies to BGP redistribution to define which routes will be redistributed into the BGP process. This is useful if you would like to redistribute only a sub-set of a type of routes.

The following diagram shows BGP redistribution attachment points.

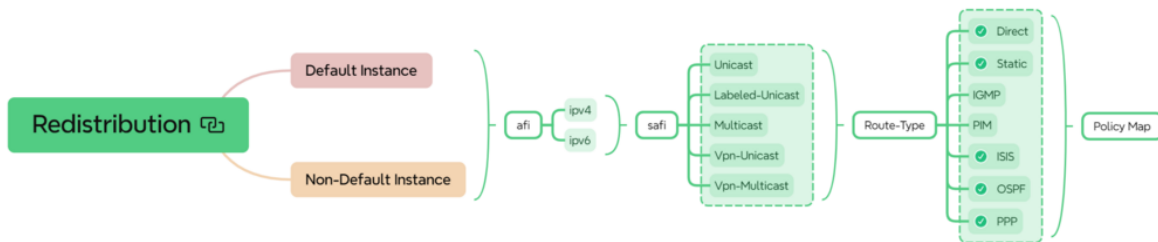

- IS-IS redistribution - Policies can be attached to IS-IS redistribution to control which routes will be redistributed into the IS-IS process.

The following diagram shows IS-IS Redistribution attachment point.

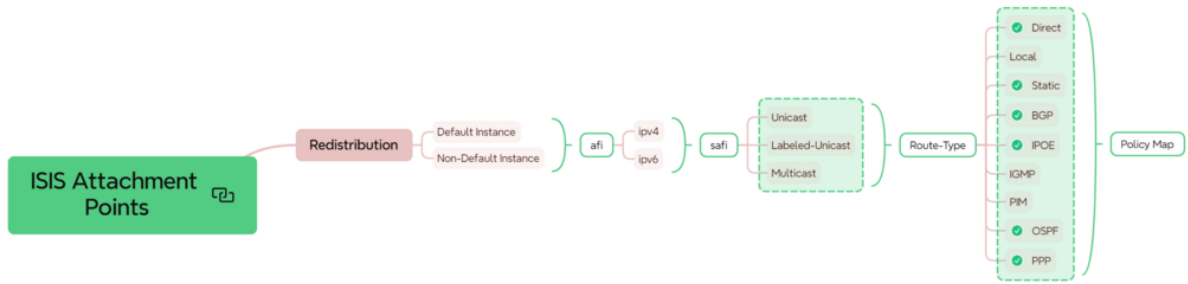

- OSPFv2 redistribution - Policies can be attached to OSPFv2 redistribution to control which routes will be redistributed into the OSPFv2 process.

The following diagram shows OSPF Redistribution attachment points.

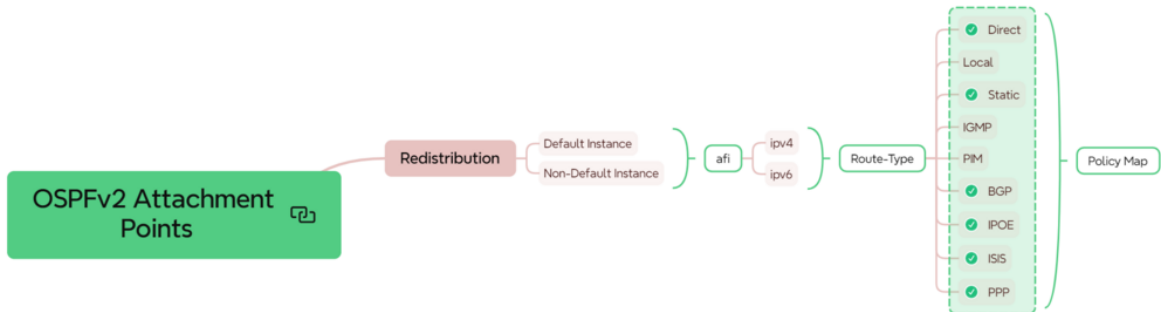

- LDP redistribution - Policies can be attached to the LDP redistribution to control which routes will be redistributed into the LDP process.

The following diagram shows LDP Redistribution attachment points.

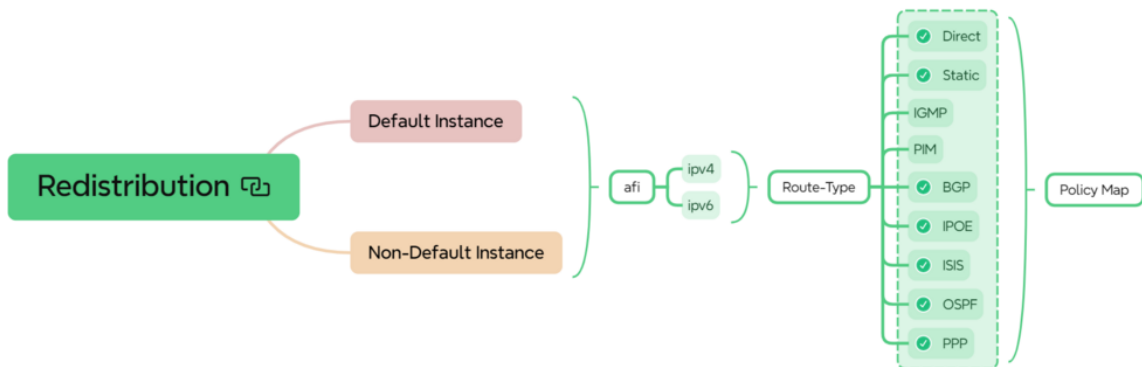

The following diagram shows LDP peer group attachment points.

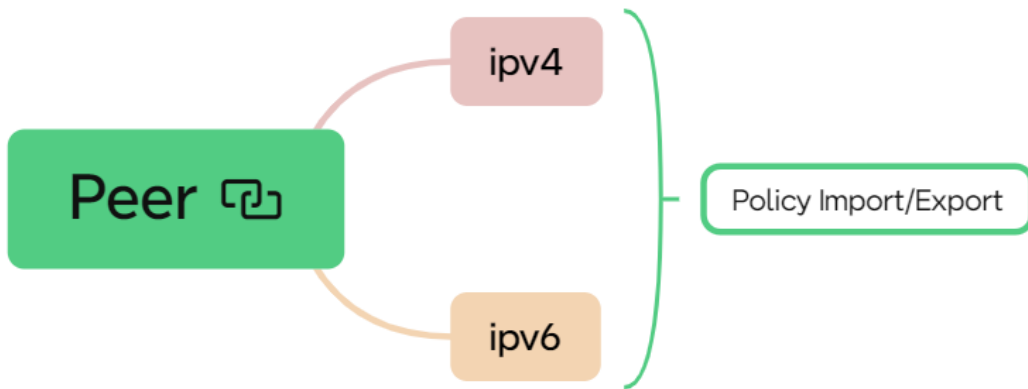

- IGMP group filtering - You can apply policies to IGMP interface profiles. Such policies act as IGMP group filters when receiving IGMP Membership Report messages.
- IGMP SSM-mapping - Policies are further used to define SSM mapping. SSM mapping policies attached to IGMP interface profiles define how to translate IGMPv2 (\*,G) to IGMPv3 (S,G) Reports.

The following diagram shows IGMP attachment points.

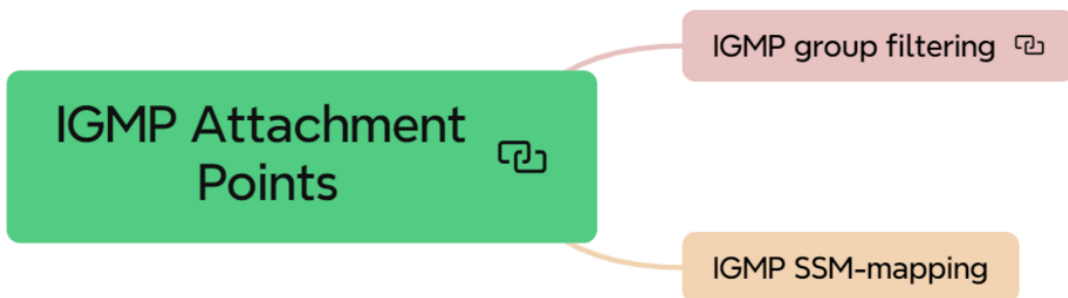

## Policy Behaviour

The default behaviour of a policy is **deny**. This means, if a route or any other object is subject to a policy, by default it will be marked as **deny**. For example in case of an import policy, it will not be imported. A policy will **permit** an object, for example import a route, if the route or object successfully matches the match rules, and if there is an action rule with a **permit**. In addition, further operations like modifying

route attributes might be executed.

Policy ordinals are executed in the order of the ordinal numbers.

- If an ordinal results in a terminating action like **permit** or **deny**, the policy processing is completed for the respective object. Subsequent ordinals will not be processed.
- If an ordinal does not result in a match, the next ordinal is processed.

There might be situations in which a policy configuration is not complete or not valid. In particular, a policy may contain a match or action type not supported by an attachment point. For example, the **ipv4-mcast-group** type is not supported by BGP or IS-IS. The following list summarizes the behaviour for such invalid scenarios:

- If a policy is attached but does not exist, all routes or objects will be denied.
- If a policy contains only statements, or only statements and ordinals, but no match and action block, it will deny all.
- If a match or action type is not supported by the attachment point, the policy will ignore the unsupported rule and process only the supported rules. For any ignored rule, the default **deny** is not impacted. The behaviour will be the same as if the unsupported rule does not exist.

## Match Type

The Match Type refers to the criteria or conditions used to determine if a particular route or set of routes should be acted upon by the policy. It specifies which attributes of the routes are to be evaluated to see if they meet the policy conditions.

The following diagram shows various match types supported.

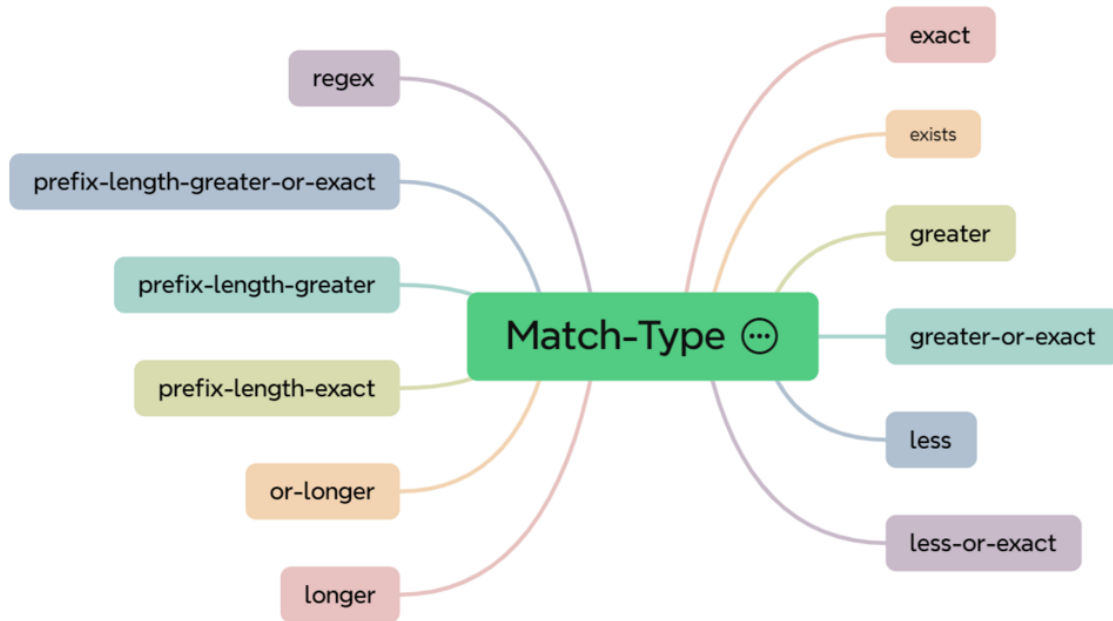

## Operation Type

The Operation Type refers to the actions applied to the routes that match the specified criteria or match types within the policy. Once a route matches the conditions set by the match types, the operation type dictates what is to be done with the route.

The following diagram shows various operation types supported.

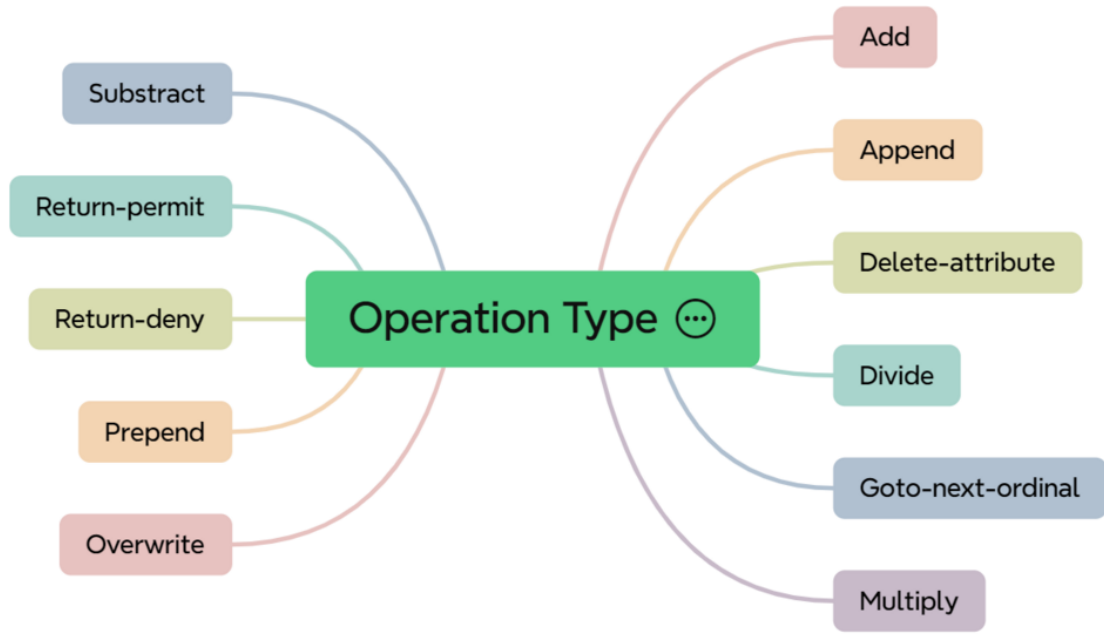

## Attribute Type

The Attribute Type refers to the specific properties of routes that can be matched against or modified within the policy. These attributes are used to define conditions (match types) or actions (operation types) on the routes.

The following diagram shows various attribute types supported.



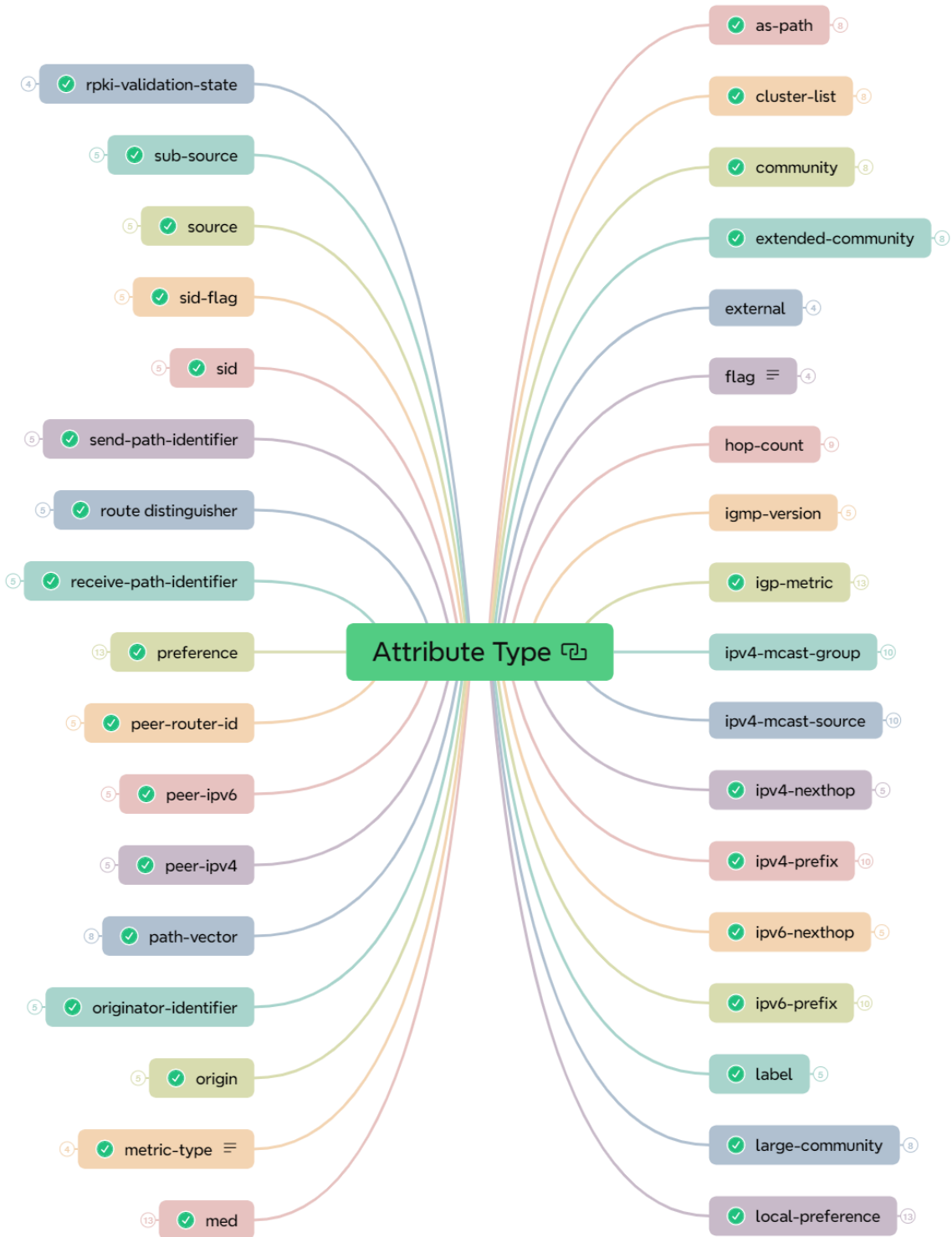

## Policy Chaining

Multiservice edge nodes, such as Broadband Network Gateways (BNG) and peering points, manage routes from various sources. The complexity of policy configurations for these routes can be significant. Certain policies, like filtering private IP addresses and removing private Autonomous System (AS) numbers from the AS path, are frequently reused across different router application points.

Therefore, implementing modularization and enabling the chaining of these policies improve both maintainability and clarity in policy configurations.

Policy chaining is used to modularize monolithic complex routing policies into multiple smaller policies that are executed in a predefined order and are easier to maintain.

Benefits of using policy chaining:

- **Rule Reusability:** Reuse common rules (for example, RFC1918, bogon filtering) across multiple chains, simplifying configuration.
- **Custom Policies:** Create customer-specific policies by combining existing rules for different peering scenarios (transit, upstream, public).
- **Easier Rule Updates:** Simplify updates to general rules affecting multiple policies.
- **Simplify Troubleshooting:** Make troubleshooting easier by breaking down complex configurations into reusable components.

The diagram below shows how a chain of routing policies is evaluated. When Policy Statements 1-3 are chained in configuration, the actual policy evaluation should proceed as shown in the figure below.

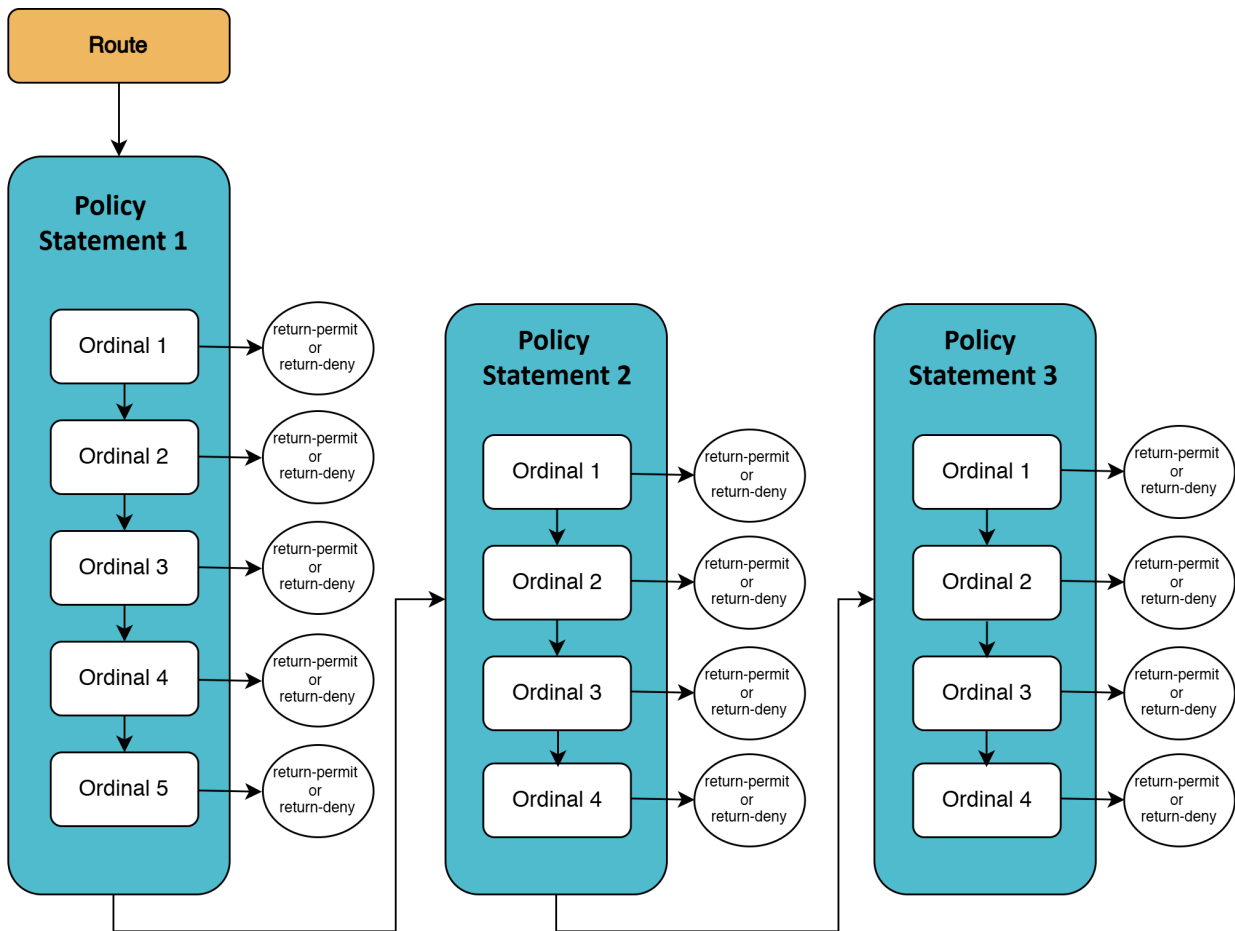

1. The route is first evaluated against the first ordinal in the first routing policy. If it matches, the specified action is taken. If the action is to “return-permit” or “return-deny” the route, that action is taken, and the evaluation of the route ends. If the goto-next-ordinal action is specified, if no action is specified, or if the route does not match, the evaluation continues by processing the second ordinal in the first routing policy in the same manner. If goto-next-policy action is specified, the evaluation continues by processing the first ordinal of the next policy.
2. If the route does not match an ordinal or matches an ordinal with a goto-next-policy action in the first routing policy, it is evaluated against the first ordinal in the second routing policy.
3. The evaluation continues until the route matches an ordinal with a ‘return-permit’ or ‘return-deny’ action defined or until there are no more routing policies to evaluate. If there are no more routing policies, then the return-permit or return-deny action specified by the default policy is taken. If there are no more routing policies to evaluate, the default action is return-deny.

## Supported Platforms

Not all features are necessarily supported on each hardware platform. Please refer to the RBFS Platform Guide for the features and the sub-features supported or not supported for each platform.

## 2.9.2. Policy Configuration

### Configuration Hierarchy

The diagram illustrates the policy configuration hierarchy.

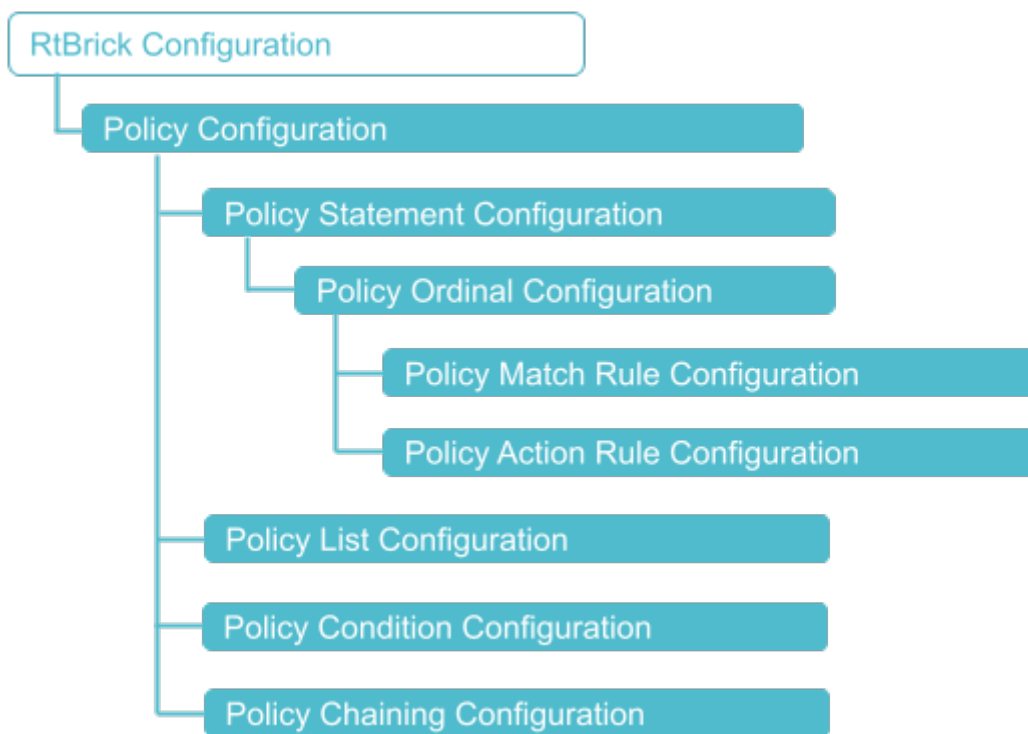

### Configuration Syntax and Commands

The following sections describe the policy configuration syntax and commands.

#### Configuring Policy Statements

**Syntax:**

**set policy statement** <policy-name> **ordinal** <number> <attribute> <value>

Attribute	Description
<policy-name>	Name of the policy statement. Policy names can contain alphanumeric characters and underscore character. They must not include special characters like hyphen. For example, <b>BGP-EXPORT</b> is not supported, whereas <b>BGP_EXPORT</b> is supported. A valid name cannot start with a number but it can contain numbers and underscore in the string. The length of the names should not exceed 64 characters.
<number>	Specifies the ordinal number.
description <text>	Description of the ordinal.
match <...>	Match configuration hierarchy. Please refer to section 2.2.1.1 for the match rule configuration.
match-logic <value>	Specifies the match logic. Supported values are <b>and</b> and <b>or</b> .
action <...>	Action configuration hierarchy. Please refer to section 2.2.1.2 for the action rule configuration.
condition <condition-name>	Optionally, apply a policy condition. Please refer to section 2.2.3 for the policy condition configuration.

## Configuring Match Rules

### Syntax:

**set policy statement** <policy-name> **ordinal** <number> **match rule** <number> <attribute> <value>

Attribute	Description
rule <number>	Specifies the match rule number.
type <attribute-type>	Specifies the attribute type. Please refer to section 2.2.1.1.1 for supported attribute types.
match-type <match-type>	Specifies the match type. Please refer to section 2.2.1.1.1 for supported match types per attribute, and to section 2.2.1.1.2 for descriptions of the match types.

Attribute	Description
value <value>	Attribute value. This is the actual value of the attribute to match, for example an IP prefix, a metric, or a community.
value-type <value-type>	Attribute value type. Supported types are <b>discrete</b> , this is a single value, and <b>list</b> , a list of values defined in a policy list.

### Attribute and Match Types

Attribute Type	Match Types Supported
ipv4-prefix	regex exact longer or-longer prefix-length-exact prefix-length-greater prefix-length-greater-or-exact
ipv6-prefix	regex exact longer or-longer prefix-length-exact prefix-length-greater prefix-length-greater-or-exact
route-distinguisher	regex exact
community	regex exact exists
extended-community	regex exact exists
large-community	regex exact exists

<b>Attribute Type</b>	<b>Match Types Supported</b>
as-path	regex exact exists
cluster-list	regex exact exists
source	regex exact
sub-source	regex exact
originator-identifier	regex exact
peer-router-id	regex exact
ipv4-next-hop	regex exact
ipv6-next-hop	regex exact
label	regex exact
peer-ipv4	regex exact
peer-ipv6	regex exact
sid	regex exact
sid-flag	regex exact
external	exact

Attribute Type	Match Types Supported
igp-metric	regex exact greater greater-or-exact less less-or-exact
rpki-validation-state	exact

### Match Types

Match Types	Description
regex	<p>An attribute can be matched using a standard Linux egrep regular expression.</p> <p>Example: "label": "label-op:push,label:206,bos:1"</p> <p>In this example, the label is a 64bit number, which has label value, bos, and operation encoding. A <b>regex</b> is used to match the string which is displayed in the table dump, that is, label-op:push,label:206,bos:1 not the 64bit value. The same is applicable to an array type attribute. A <b>regex</b> can be written to the string which is visible in the table dump output. For information about Well-known Communities match with Regex, see section "Well-known Communities Regex Match".</p>
exact	Value configured in the command must be same as application attribute value
exists	This is applicable only for array type attribute; an exist match is the one where value configured in the command must exist in the application attribute value which is an array.
less	The application attribute value must be less than the value configured in the command
less-or-exact	The application attribute value must be less than or exact value configured in the command



<b>Match Types</b>	<b>Description</b>
greater	The application attribute value must be greater than the value configured in the command
greater-or-exact	The application attribute value must be greater than or exact value configured in the command
greater-longer	The route shares the same most-significant bits (described by prefix-length), and prefix-length is greater than the route's prefix length
greater-or-longer	The route shares the same most-significant bits (described by prefix-length), and prefix-length is equal to or greater than the route's prefix length.
longer	The route address shares the same most-significant bits as the match prefix (destination-prefix or source-prefix). The number of significant bits is described by the prefix-length component of the match prefix. The match will be performed only for prefixes longer than the one supplied for matching.
or-longer	The route address shares the same most-significant bits as the match prefix (destination-prefix or the source-prefix). The number of significant bits is described by the prefix-length component of the match prefix. The match is performed for the prefix supplied and for any prefixes that are subnets of it.
prefix-length-exact	The application attribute value whose prefix length must be lesser than or exact the value configured in the command
prefix-length-greater	The application attribute value whose prefix length must be greater than the value configured in the command
prefix-length-greater-or-exact	The application attribute value whose prefix length must be greater than or exact value configured in the command

### **Well-known Communities Regex Match**

You must specify the value differently to match well-known communities using regex. For example, you can use the following regex pattern to match well-known communities: NO\_EXPORT, NO\_ADVERTISE, NO\_EXPORT\_SUBCONFED, and NOOPER.

This pattern works as follows:

NO\* matches any string that starts with NO.

This will successfully match the following well-known communities because they start with **NO**.

- NO\_EXPORT
- NO\_ADVERTISE
- "NO\_EXPORT\_SUBCONFED"
- "NOPEER"

## Configuring Action Rules

### Syntax:

**set policy statement** <policy-name> **ordinal** <number> **action rule** <number>  
 <attribute> <value>

Attribute	Description
rule <number>	Specifies the action rule number.
operation <operation-type>	Specifies the operation type. Please refer to section 2.2.1.2.1 for supported operations, and to section 2.2.1.2.2 for operations per attribute.
type <attribute-type>	Specifies the attribute type. Please refer to section 2.2.1.2.2 for supported attribute types.
value <value>	Specifies the operation value.

## Operation Types

Operation Type	Description
add	The application attribute value will be added with the value configured in the command
append	The application attribute value will be appended with the value configured in the command

Operation Type	Description
delete-attribute	Deletes the attribute from the route. It clears all the information for that specific attribute in the object.
delete-attribute-match	Deletes the specific value of an attribute from the route. It is mandatory to define match rules, before configuring the <b>delete-attribute-match</b> action rule.
divide	The application attribute value will be divided with the value configured in the command
goto-next-ordinal	If next term exists, then next term is executed and the policy result is decided based on the result of the execution
multiply	The application attribute value will be multiplied with the value configured in the command
overwrite	The application attribute value will be overwritten with the value configured in the command
prepend	The application attribute value will be prefixed with the value configured in the command
return-deny	Stops policy execution and returns result as <b>deny</b> (resulting route/BDS object to be denied)
return-permit	Stops policy execution and return result as permit (resulting route/BDS object to be permitted)
subtract	The application attribute value will be subtracted with the value configured in the command. If the result of the subtraction results in a number less than 0, the value "0" is used.

### Attribute Types and Supported Operations

Attribute Type	Operation Types Supported
ipv4-prefix	overwrite
ipv6-prefix	overwrite
route-distinguisher	overwrite
community	append prepend overwrite

<b>Attribute Type</b>	<b>Operation Types Supported</b>
extended-community	append prepend overwrite
large-community	append prepend overwrite
as-path	append prepend overwrite
cluster-list	append prepend overwrite
source	overwrite
sub-source	overwrite
originator-identifier	overwrite
peer-router-id	overwrite
ipv4-next-hop	overwrite
ipv6-next-hop	overwrite
label	overwrite
peer-ipv4	overwrite
peer-ipv6	overwrite
sid	overwrite
sid-flag	overwrite
external	overwrite
igp-metric	add subtract multiply divide overwrite
metric-type	overwrite
rpki-validation-state	overwrite

## Example 1: Policy statement configuration

```

{
  "rtbrick-config:policy": {
    "statement": [
      {
        "name": "EXPORT_POLICY1",
        "ordinal": [
          {
            "ordinal": 10,
            "description": "Add BGP community to direct routes",
            "match-logic": "and",
            "match": {
              "rule": [
                {
                  "rule": 1,
                  "type": "ipv6-prefix",
                  "value-type": "discrete",
                  "match-type": "or-longer",
                  "value": "2001:db8:0:60::/32"
                },
                {
                  "rule": 2,
                  "type": "source",
                  "value-type": "discrete",
                  "match-type": "exact",
                  "value": "direct"
                }
              ]
            },
            "action": {
              "rule": [
                {
                  "rule": 1,
                  "type": "community",
                  "operation": "append",
                  "value": "100:1"
                },
                {
                  "rule": 2,
                  "operation": "return-permit"
                }
              ]
            }
          },
          {
            "ordinal": 20,
            "description": "Allow any other route",
            "action": {
              "rule": [
                {
                  "rule": 1,
                  "operation": "return-permit"
                }
              ]
            }
          }
        ]
      }
    ]
  }
}

```

```
}
}
```

## Example 2: Policy statement configuration for RPKI Validation State Overwrite

```
{
  "rtbrick-config:policy": {
    "statement": [
      {
        "name": "S1",
        "ordinal": [
          {
            "ordinal": 1,
            "match-logic": "and",
            "match": {
              "rule": [
                {
                  "rule": 1,
                  "type": "rpki-validation-state",
                  "value-type": "discrete",
                  "match-type": "exact",
                  "value": [
                    "invalid"
                  ]
                },
                {
                  "rule": 2,
                  "type": "ipv4-prefix",
                  "value-type": "discrete",
                  "match-type": "exact",
                  "value": [
                    "192.168.0.11/32"
                  ]
                }
              ]
            },
            "action": {
              "rule": [
                {
                  "rule": 1,
                  "type": "rpki-validation-state",
                  "operation": "overwrite",
                  "value": [
                    "unknown"
                  ]
                }
              ]
            }
          ]
        ]
      }
    ]
  }
}
```

## Configuring Policy Lists

### Syntax:

**set policy list** <list-name> <list-type> **ordinal** <ordinal-number> **value** <value>

Attribute	Description
<list-name>	Name of the policy list
<list-type>	Type of the policy list. The following types of lists are supported: <ul style="list-style-type: none"> <li>- as-path</li> <li>- cluster-list</li> <li>- community</li> <li>- route-distinguisher</li> <li>- extended-community</li> <li>- ipv4-address</li> <li>- ipv4-mcast-group</li> <li>- ipv4-prefix</li> <li>- ipv6-address</li> <li>- ipv6-prefix</li> <li>- large-community</li> <li>- mpls-label</li> <li>- source</li> <li>- sub-source</li> </ul>
<ordinal-number>	The number of the list entry.
<value>	The value of the list entry, for example an IP prefix, or a community.

### Example: Policy list configuration

```
{
  "rtbrick-config:policy": {
    "list": [
      {
        "name": "PREFIX_LIST1",
        "type": "ipv6-prefix",
        "ordinal": [
          {
            "ordinal": 1,
            "value": "2001:db8:0:10::/32"
          }
        ]
      }
    ]
  }
}
```

```

    },
    {
      "ordinal": 2,
      "value": "2001:db8:0:25::/32"
    },
    {
      "ordinal": 3,
      "value": "2001:db8:0:30::/32"
    }
  ]
}
}
}

```

### Configuring Policy Conditions

Policy conditions refer to certain states of the system represented in BDS tables. You need to specify the table, the daemon (BD) that needs to resolve the condition, and if applicable, the attributes used to define the condition.

There are two types of conditions:

- Match on certain attributes in BDS table objects.
- Match on the number of objects in a BDS table.

### Configuring Table Match

**Syntax:**

**set policy condition** <condition-name> **table** <attribute> <value>

Attribute	Description
<condition-name>	Name of the policy condition
name <table-name>	Name of the BDS table
bd <bd-name>	Name of the BD which resolves the condition. Currently supported BDs are: ifmd, ribd, mribd, pppoed, subscriberd, ipoed, l2tpd, pimd, igmp.iod, isis.iod, ospf.appd ospf.iod
count <number>	Optionally, match on the number of objects in a table



Attribute	Description
match <type>	Type of match for an object count. Supported match types are: equal greater greater-or-equal less less-or-equal

## Configuring Attribute Match

You can configure attributes to define a condition. The attributes refer to objects in the table configured in the section above. Please note:

- You can match on multiple attributes.
- In order to identify matching objects, you need to specify all attributes which are primary keys in the table.
- Attribute configuration is not required for conditions matching on the number of table objects using the **count** option.

### Syntax:

**set policy condition** <condition-name> **attribute** <name> <attribute> <value>

Attribute	Description
<condition-name>	Name of the policy condition
attribute <name>	Name of the attribute in the BDS table
value <value>	Value of the attribute to match
match <type>	Type of the match. Supported match types are: equal exists greater greater-or-equal less less-or-equal regex

## Example: Policy condition configuration

```
{
  "rtbrick-config:policy": {
    "condition": [
      {
        "condition_name": "precheck",
        "table": {
          "name": "global.instance",
          "bd": "bgp.iod.1"
        },
        "attribute": [
          {
            "name": "instance_name",
            "match": "equal",
            "value": "default"
          }
        ]
      }
    ]
  }
}
```

### Attaching Policies

Once a policy has been created, they need to be applied to an application like a routing protocol to take effect.

### BGP Attachment Points

- Instance import/export
- BGP peer group import/export
- BGP redistribution

For attaching policies to the BGP protocol, please refer to the RBFS BGP User Guide.

### IS-IS Attachment Points

- IS-IS redistribution

For attaching policies to the IS-IS protocol, please refer to the IS-IS User Guide.

### OSPFv2 Attachment Points

- OSPFv2 redistribution

For attaching policies to the OSPFv2/v3 protocol, please refer to the OSPFv2 User Guide.

### LDP Attachment Points

- LDP redistribution#

For attaching policies to the LDP protocol, please refer to the LDP User Guide.

### IGMP Attachment Points

- IGMP group filtering
- IGMP SSM-mapping

For attaching policies to the IGMP protocol, please refer to the RBFS IP Multicast Routing Configuration Guide.

### Policy Chaining Configuration

The following configuration demonstrates how policy chaining is applied for the PEERING\_V4 BGP peer group. For IPv4 unicast address family, incoming routes will be evaluated and imported only if they meet the criteria defined in the associated import policies. These policies provide layered route filtering, ensuring that only valid and desired routes are accepted by the peer.

The configuration applies a series of import policies for the IPv4 unicast address family. These policies are chained in sequence, each performing specific tasks such as:

- Filtering bogon IPs (FILTER\_BOGONS\_V4).
- Preventing the import of the peer's own IP ranges (FILTER\_OWN\_V4).
- Scrubbing unwanted community tags (SCRUB\_COMMUNITIES).

The following example shows the policy chaining configuration for the peer-group "PEERING\_V4."

```
set instance default protocol bgp peer-group PEERING_V4
set instance default protocol bgp peer-group PEERING_V4 remote-as 65536
set instance default protocol bgp peer-group PEERING_V4 address-family ipv4
labeled-unicast
set instance default protocol bgp peer-group PEERING_V4 address-family ipv4
unicast
```

```

set instance default protocol bgp peer-group PEERING_V4 address-family ipv4
unicast policy import FILTER_BOGONS_V4
set instance default protocol bgp peer-group PEERING_V4 address-family ipv4
unicast policy import FILTER_OWN_V4
set instance default protocol bgp peer-group PEERING_V4 address-family ipv4
unicast policy import SCRUB_COMMUNITIES

```

```

supervisor@rtbrick>SPINE01: cfg> show config instance default protocol bgp peer-
group PEERING_V4
{
  "rtbrick-config:peer-group": [
    {
      "pg-name": "PEERING_V4",
      "remote-as": 65536,
      "address-family": [
        {
          "afi": "ipv4",
          "safi": "labeled-unicast"
        },
        {
          "afi": "ipv4",
          "safi": "unicast",
          "policy": {
            "import": [
              "FILTER_BOGONS_V4",
              "FILTER_OWN_V4",
              "SCRUB_COMMUNITIES"
            ]
          }
        },
        {
          "afi": "ipv6",
          "safi": "labeled-unicast"
        },
        {
          "afi": "ipv6",
          "safi": "unicast"
        }
      ]
    }
  ]
}
supervisor@rtbrick>SPINE01: cfg>

```

## Policy Statement Configurations for Policy Chaining

The following configurations provide a detailed representation of the policy statements utilized in the aforementioned policy chaining example.

The example below shows the policy definitions for the FILTER\_BOGONS\_V4 policy statement.

```

set policy statement FILTER_BOGONS_V4
set policy statement FILTER_BOGONS_V4 ordinal 1
set policy statement FILTER_BOGONS_V4 ordinal 1 description FILTER_BOGONS

```

```

set policy statement FILTER_BOGONS_V4 ordinal 1 match-logic or
set policy statement FILTER_BOGONS_V4 ordinal 1 match
set policy statement FILTER_BOGONS_V4 ordinal 1 match rule 1
set policy statement FILTER_BOGONS_V4 ordinal 1 match rule 1 type ipv4-prefix
set policy statement FILTER_BOGONS_V4 ordinal 1 match rule 1 value-type list
set policy statement FILTER_BOGONS_V4 ordinal 1 match rule 1 match-type or-longer
set policy statement FILTER_BOGONS_V4 ordinal 1 match rule 1 value FILTER_BOGONS
set policy statement FILTER_BOGONS_V4 ordinal 1 match rule 2
set policy statement FILTER_BOGONS_V4 ordinal 1 match rule 2 type ipv4-prefix
set policy statement FILTER_BOGONS_V4 ordinal 1 match rule 2 value-type discrete
set policy statement FILTER_BOGONS_V4 ordinal 1 match rule 2 match-type regex
set policy statement FILTER_BOGONS_V4 ordinal 1 match rule 2 value 0.0.0.0/(2[5-9]|3[0-1])
set policy statement FILTER_BOGONS_V4 ordinal 1 action
set policy statement FILTER_BOGONS_V4 ordinal 1 action rule 1
set policy statement FILTER_BOGONS_V4 ordinal 1 action rule 1 operation return-deny
set policy statement FILTER_BOGONS_V4 ordinal 2
set policy statement FILTER_BOGONS_V4 ordinal 2 description FILTER_IXP
set policy statement FILTER_BOGONS_V4 ordinal 2 match
set policy statement FILTER_BOGONS_V4 ordinal 2 match rule 1
set policy statement FILTER_BOGONS_V4 ordinal 2 match rule 1 type ipv4-prefix
set policy statement FILTER_BOGONS_V4 ordinal 2 match rule 1 value-type list
set policy statement FILTER_BOGONS_V4 ordinal 2 match rule 1 match-type or-longer
set policy statement FILTER_BOGONS_V4 ordinal 2 match rule 1 value
IXP_PEERING_LANS_V4
set policy statement FILTER_BOGONS_V4 ordinal 2 action
set policy statement FILTER_BOGONS_V4 ordinal 2 action rule 1
set policy statement FILTER_BOGONS_V4 ordinal 2 action rule 1 operation return-deny

```

The example below shows the configurations of the 'FILTER\_BOGONS' policy list used in the 'FILTER\_BOGONS\_V4' policy statement.

```

supervisor@S1-STD-2-2004>bm04-tst.fsn.rtbrick.net: op> show config set policy list
FILTER_BOGONS
set policy list FILTER_BOGONS ipv4-prefix
set policy list FILTER_BOGONS ipv4-prefix ordinal 1
set policy list FILTER_BOGONS ipv4-prefix ordinal 1 value 0.0.0.0/8
set policy list FILTER_BOGONS ipv4-prefix ordinal 2
set policy list FILTER_BOGONS ipv4-prefix ordinal 2 value 10.0.0.0/8
set policy list FILTER_BOGONS ipv4-prefix ordinal 3
set policy list FILTER_BOGONS ipv4-prefix ordinal 3 value 100.64.0.0/10
set policy list FILTER_BOGONS ipv4-prefix ordinal 4
set policy list FILTER_BOGONS ipv4-prefix ordinal 4 value 127.0.0.0/8

```

The example below shows the configurations of the 'IXP\_PEERING\_LANS\_V4' policy list used in the 'FILTER\_BOGONS\_V4' policy statement.

```

set policy list IXP_PEERING_LANS_V4 ipv4-prefix
set policy list IXP_PEERING_LANS_V4 ipv4-prefix ordinal 1
set policy list IXP_PEERING_LANS_V4 ipv4-prefix ordinal 1 value 80.81.192.0/21
set policy list IXP_PEERING_LANS_V4 ipv4-prefix ordinal 2
set policy list IXP_PEERING_LANS_V4 ipv4-prefix ordinal 2 value 80.249.208.0/21
set policy list IXP_PEERING_LANS_V4 ipv4-prefix ordinal 3

```

```
set policy list IXP_PEERING_LANS_V4 ipv4-prefix ordinal 3 value 91.213.211.0/24
set policy list IXP_PEERING_LANS_V4 ipv4-prefix ordinal 4
set policy list IXP_PEERING_LANS_V4 ipv4-prefix ordinal 4 value 185.0.20.0/23
```

The example below shows the policy definitions for the FILTER\_OWN\_V4 policy statement.

```
set policy statement FILTER_OWN_V4
set policy statement FILTER_OWN_V4 ordinal 1
set policy statement FILTER_OWN_V4 ordinal 1 match
set policy statement FILTER_OWN_V4 ordinal 1 match rule 1
set policy statement FILTER_OWN_V4 ordinal 1 match rule 1 type ipv4-prefix
set policy statement FILTER_OWN_V4 ordinal 1 match rule 1 value-type list
set policy statement FILTER_OWN_V4 ordinal 1 match rule 1 match-type or-longer
set policy statement FILTER_OWN_V4 ordinal 1 match rule 1 value MYPREFIXES_V4
set policy statement FILTER_OWN_V4 ordinal 1 action
set policy statement FILTER_OWN_V4 ordinal 1 action rule 1
set policy statement FILTER_OWN_V4 ordinal 1 action rule 1 operation return-deny
```

The example below shows the configurations of the 'MYPREFIXES\_V4' policy list used in the 'FILTER\_OWN\_V4' policy statement.

```
set policy list MYPREFIXES_V4 ipv4-prefix
set policy list MYPREFIXES_V4 ipv4-prefix ordinal 1
set policy list MYPREFIXES_V4 ipv4-prefix ordinal 1 value 5.159.24.0/21
set policy list MYPREFIXES_V4 ipv4-prefix ordinal 2
set policy list MYPREFIXES_V4 ipv4-prefix ordinal 2 value 46.17.108.0/22
set policy list MYPREFIXES_V4 ipv4-prefix ordinal 3
set policy list MYPREFIXES_V4 ipv4-prefix ordinal 3 value 62.176.224.0/19
set policy list MYPREFIXES_V4 ipv4-prefix ordinal 4
set policy list MYPREFIXES_V4 ipv4-prefix ordinal 4 value 91.186.32.0/19
```

The example below shows the policy definitions for the SCRUB\_COMMUNITIES policy statement.

```
set policy statement SCRUB_COMMUNITIES
set policy statement SCRUB_COMMUNITIES ordinal 1
set policy statement SCRUB_COMMUNITIES ordinal 1 match
set policy statement SCRUB_COMMUNITIES ordinal 1 match rule 1
set policy statement SCRUB_COMMUNITIES ordinal 1 match rule 1 type community
set policy statement SCRUB_COMMUNITIES ordinal 1 match rule 1 value-type discrete
set policy statement SCRUB_COMMUNITIES ordinal 1 match rule 1 match-type regex
set policy statement SCRUB_COMMUNITIES ordinal 1 match rule 1 value 9136:*
set policy statement SCRUB_COMMUNITIES ordinal 1 action
set policy statement SCRUB_COMMUNITIES ordinal 1 action rule 1
set policy statement SCRUB_COMMUNITIES ordinal 1 action rule 1 type community
set policy statement SCRUB_COMMUNITIES ordinal 1 action rule 1 operation delete-attribute-match
```

## Sample Configurations

### Example 1: BGP export policy referencing a policy list

```
supervisor@leaf1: cfg> show config policy
{
  "rtbrick-config:policy": {
    "list": [
      {
        "name": "PREFIX_LIST2",
        "type": "ipv6-prefix",
        "ordinal": [
          {
            "ordinal": 1,
            "value": "2001:db8:0:60::/32"
          },
          {
            "ordinal": 2,
            "value": "2001:db8:0:80::/64"
          },
          {
            "ordinal": 3,
            "value": "2001:db8:0:110::/64 "
          }
        ]
      }
    ]
  },
  "statement": [
    {
      "name": "EXPORT_POLICY2",
      "ordinal": [
        {
          "ordinal": 10,
          "description": "Add community to direct routes",
          "match": {
            "rule": [
              {
                "rule": 1,
                "type": "source",
                "value-type": "discrete",
                "match-type": "exact",
                "value": "direct"
              }
            ]
          },
          "action": {
            "rule": [
              {
                "rule": 1,
                "type": "community",
                "operation": "append",
                "value": "100:1"
              },
              {
                "rule": 2,
                "operation": "return-permit"
              }
            ]
          }
        }
      ]
    }
  ]
}
```

```

    },
    {
      "ordinal": 20,
      "description": "Allow list of routes",
      "match": {
        "rule": [
          {
            "rule": 1,
            "type": "ipv6-prefix",
            "value-type": "list",
            "match-type": "or-longer",
            "value": "PREFIX_LIST2"
          }
        ]
      },
      "action": {
        "rule": [
          {
            "rule": 1,
            "operation": "return-permit"
          }
        ]
      }
    },
    {
      "ordinal": 30,
      "description": "Deny any other route",
      "action": {
        "rule": [
          {
            "rule": 1,
            "operation": "return-deny"
          }
        ]
      }
    }
  ]
}

```

```

supervisor@leaf1: cfg> show config instance default protocol bgp peer-group spine
address-family ipv6 unicast
{
  "rtbrick-config:address-family": [
    {
      "afi": "ipv6",
      "safi": "unicast",
      "policy": {
        "export": "EXPORT_POLICY2"
      }
    }
  ]
}

```

## Example 2: IGMP filter policy



```

supervisor@leaf1: cfg> show config policy
{
  "rtbrick-config:policy": {
    "statement": [
      {
        "name": "IGMP_FILTER",
        "ordinal": [
          {
            "ordinal": 1,
            "description": "IGMP group filter",
            "match-logic": "or",
            "match": {
              "rule": [
                {
                  "rule": 1,
                  "type": "ipv4-mcast-group",
                  "value-type": "discrete",
                  "match-type": "or-longer",
                  "value": "198.51.100.30/24"
                },
                {
                  "rule": 2,
                  "type": "ipv4-mcast-group",
                  "value-type": "discrete",
                  "match-type": "or-longer",
                  "value": "198.51.100.40/24"
                }
              ]
            },
            "action": {
              "rule": [
                {
                  "rule": 1,
                  "operation": "return-permit"
                }
              ]
            }
          }
        ]
      }
    ]
  }
}

```

```

supervisor@leaf1: cfg> show config multicast-options igmp
{
  "rtbrick-config:igmp": {
    "interface-profile": [
      {
        "profile-name": "PROFILE1",
        "filter-policy": "IGMP_FILTER"
      }
    ]
  }
}

```

#### Example 4: Community Deletion Configuration

```
supervisor@rtbrick: cfg> show config policy
{
  "rtbrick-config:policy": {
    "statement": [
      {
        "name": "test_policy",
        "ordinal": [
          {
            "ordinal": 1,
            "match-logic": "or",
            "match": {
              "rule": [
                {
                  "rule": 1,
                  "type": "community",
                  "value-type": "discrete",
                  "match-type": "exists",
                  "value": [
                    "1:1"
                  ]
                },
                {
                  "rule": 2,
                  "type": "extended-community",
                  "value-type": "discrete",
                  "match-type": "exists",
                  "value": [
                    "target:3.3.3.3:3000",
                    "target:5.5.5.5:5000"
                  ]
                },
                {
                  "rule": 3,
                  "type": "large-community",
                  "value-type": "discrete",
                  "match-type": "exists",
                  "value": [
                    "3333:33333:33",
                    "4444:44444:44"
                  ]
                },
                {
                  "rule": 4,
                  "type": "community",
                  "value-type": "discrete",
                  "match-type": "regex",
                  "value": [
                    "555:*"
                  ]
                }
              ]
            },
            "action": {
              "rule": [
                {
                  "rule": 1,
                  "type": "community",
                  "operation": "delete-attribute-match"
                },
                {

```

```

        "rule": 2,
        "type": "extended-community",
        "operation": "delete-attribute-match"
      },
      {
        "rule": 3,
        "type": "large-community",
        "operation": "delete-attribute-match"
      }
    ]
  }
}
}

```

## 2.9.3. Policy Operational Commands

### Policy Test

You can use the policy test feature to test a policy before attaching it to a protocol or an instance.

Perform the following tasks:

- Step 1: Identify the brick daemon that will process the policy and the table to which the policy will be applied.
- Step 2: Execute the 'test policy run' command.

Example: Testing a BGP VPN export policy

```

supervisor@leaf1: op> test policy run bgp.appd.1 policy-name VPN_V4_EXPORT table
default.bgp.rib-in.import.ipv4.vpn-unicast

```

- Step 3: View the test results.

The policy test feature will create two result tables. The result table ending with ".policy.permit" will show all objects permitted by the policy, the one ending with ".policy.deny" will show all objects denied by the policy.

Example: Viewing the result tables

```

supervisor@leaf1: op> show datastore bgp.appd.1 table default.bgp.rib-
in.import.ipv4.vpn-unicast.policy.permit

```

```
<...>
supervisor@leaf1: op> show datastore bgp.appd.1 table default.bgp.rib-
in.import.ipv4.vpn-unicast.policy.deny
<...>
```

- Step 4: Clear the result tables

You can clear the result tables using the 'test policy clear' command. Apply the clear command to the same table for which you have run the policy test.

Example: Clearing the result tables

```
supervisor@leaf1: op> test policy clear bgp.appd.1 policy-name VPN_V4_EXPORT table
default.bgp.rib-in.import.ipv4.vpn-unicast
```

## 2.10. Static Routing

### 2.10.1. Static Routing Overview

Static routing allows a network administrator to configure routes manually. Using the RtBrick CLI, you can configure static IPv4, IPv6, MPLS, and multicast routes.

#### Supported Platforms

Not all features are necessarily supported on each hardware platform. Refer to the Platform Guide for the features and the sub-features that are or are not supported by each platform.

### 2.10.2. Static Routing Configuration

#### Configuration Hierarchy

The diagram illustrates the static routes configuration hierarchy.

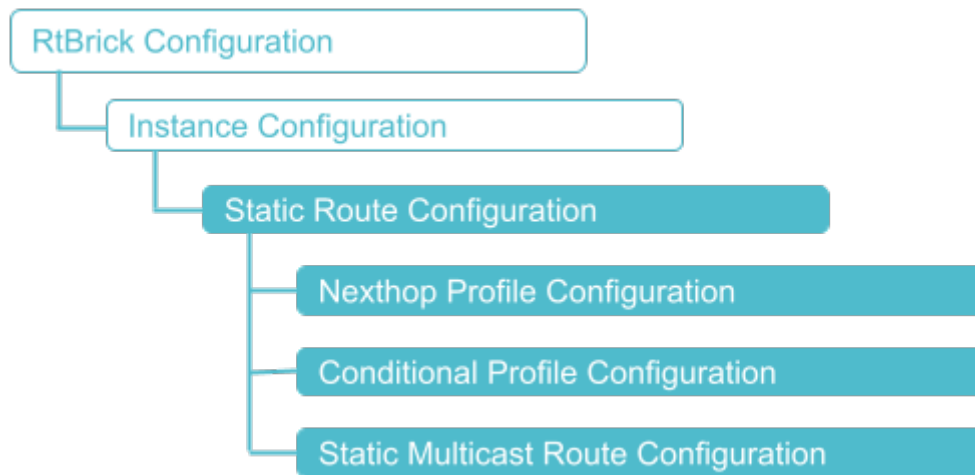

## Configuration Syntax and Commands

The following sections describe the static route configuration syntax and commands. In RBFS, next hops of static routes are configured separately, and referenced by the actual routes.

### Static Route Configuration

This section describes how to configure the static route itself.

#### Syntax

**set instance** <instance-name> **static route** <attribute> <value>

Attribute	Description
<instance-name>	Name of the routing instance
<afi> <prefix   label> (true   false)	Supported AFIs are ipv4, ipv6, and mpls. In case of IPv4 or IPv6, configure the prefix. In case of MPLS, configure the incoming label and BOS flag.
<safi>	Supported SAFIs are unicast, labeled-unicast, and multicast.
<nexthop-profile>	Name of the nexthop profile
route-options no-install	This option keeps the routes in the routing information base, but prevents them from being used for forwarding traffic.

Example: Static Route Configuration

```
{
  "rtbrick-config:route": {
    "ipv4": [
      {
        "prefix4": "198.51.100.15/24",
        "safi": "unicast",
        "nexthop-profile": "nexthop1",
        "preference": 20
      }
    ],
    "ipv6": [
      {
        "prefix6": "2001:db8:0:117::/32",
        "safi": "unicast",
        "nexthop-profile": "nexthop2"
      }
    ],
    "mpls": [
      {
        "in-label": 8888,
        "in-bos": "true",
        "safi": "unicast",
        "nexthop-profile": "nexthop1"
      }
    ]
  }
}
```

### Example: Static Route Configuration with route-options no install

```
supervisor@rtbrick.net: cfg> show config instance default static route ipv4
192.1.0.6/32
{
  "rtbrick-config:ipv4": [
    {
      "prefix4": "192.1.0.6/32",
      "safi": "labeled-unicast",
      "nexthop-profile": "nh1",
      "route-options": "no-install"
    },
    {
      "prefix4": "192.1.0.6/32",
      "safi": "unicast",
      "nexthop-profile": "nh1"
    }
  ]
}
```

### Nexthop Profile Configuration

You can group various nexthop parameters with a nexthop profile name and instance, and associate this nexthop profile with multiple routes.

## Syntax

**set instance** <instance-name> **static nexthop-profile** <name> <attribute>  
<value>

Attribute	Description
<instance-name>	Name of the routing instance
nexthop-profile <name>	Nexthop profile name
exit-interface <exit-interface>	Exit interface name
lookup-afi (ipv4   ipv6   mpls)	Lookup routing table address family where the nexthop will be resolved.
lookup-instance <lookup-instance>	Lookup routing table instance where the nexthop will be resolved.
lookup-safi (labeled-unicast   multicast   unicast)	Lookup routing table subsequent address family where the nexthop will be resolved.
nexthop <address>	IPv4/IPv6 nexthop address
out-bos (true   false)	Label BOS
out-label <out-label>	Label to be pushed
resolve-direct true	The option restricts all routes from resolving the nexthop of a static route instead, it allows only the direct routes to resolve the nexthop of a static route.

### Example: Nexthop Profile Configuration

```
{
  "rtbrick-config:static": {
    "nexthop-profile": [
      {
        "name": "nexthop1",
        "nexthop": "198.51.100.145",
        "out-label": 4444
      },
      {
        "name": "nexthop3",
        "exit-interface": "ifp-0/0/4/4"
      }
    ]
  }
}
```



- If you do not provide lookup-instance, lookup-afi and lookup-safi values, default values will be used to install the route.
- The exit interface attribute is mandatory for link-local nexthop.

## Conditional Profile Configuration

By using the conditional static route feature, you can make specific routes conditional. These conditional routes are installed only if the specified condition is satisfied.

You can group various conditional parameters such as match-instance, match-afi, match-safi, compare-operation, compare-type, and compare-value with a conditional profile name, and associate this conditional profile with multiple routes.

### Syntax:

```
set instance <instance-name> static conditional-profile <name> <attribute> <value>
```

Attribute	Description
conditional <name>	Conditional profile name
compare-operation greater-then	Conditional routing compare operation
compare-type route-count	Conditional routing compare type
compare-value <compare-value>	Conditional routing condition value
match-instance <instance-name>	Routing instance where the condition will be checked.
match-afi (ipv4   ipv6   mpls)	Routing tables address family (AFI) for which the condition will be checked.
match-safi (labeled-unicast   multicast   unicast)	Routing table subsequent address family (SAFI) for which the condition will be checked.

### Example: Conditional Profile Configuration

```
{
```



```

"rtbrick-config:conditional-profile": [
  {
    "name": "c2",
    "match-instance": "default",
    "match-afi": "ipv4",
    "match-safi": "unicast",
    "compare-type": "route-count",
    "compare-operation": "greater-than",
    "compare-value": 20
  }
]
    
```

## Static Multicast Route Configuration

### Syntax:

**set instance** <instance-name> **static route multicast4** <attribute> <value

Attribute	Description
<instance-name>	Name of the routing instance
<source>	IPv4 multicast source address
<group>	IPv4 multicast group address

### Example: Static Multicast Route Configuration

```

{
  "rtbrick-config:static": {
    "route": {
      "multicast4": [
        {
          "source": "198.51.100.15/24",
          "group": "198.51.100.35/24",
          "nexthop-profile": "nexthop3"
        }
      ]
    }
  }
}
    
```

## 2.10.3. Static Routing Operational Commands

### Show Commands

## Static Routes Created by staticd

These commands show static routes as created by the static route daemon (staticd).

### Syntax:

**show static route** <options>

Attribute	Description
<afi>	Supported AFIs are ipv4, ipv6, and mpls.
<safi>	Supported SAFIs are unicast, labeled-unicast, and multicast.
instance <name>	Static routes for an instance

Example: List static routes for all instances

```

supervisor@dev1: cfg> show static route
Instance: default, AFI: ipv4, SAFI: unicast
Prefix/Label      Pref  Next Hop      Interface
198.51.100.100/24  2     198.51.100.22 -
Instance: default, AFI: ipv6, SAFI: unicast
Prefix/Label      Pref  Next Hop      Interface
2001:db8:0:334::/32  2     2001:db8:0:99:: -
    
```

## Static Routes in the Routing Table

These commands show the static routes included in the final routing table.

### Syntax:

**show route** <options> **source static** <options>

Attribute	Description
<afi>	Supported AFIs are ipv4, ipv6, and mpls.
<safi>	Supported SAFIs are unicast, labeled-unicast, and multicast.
detail	Detailed route information
instance <name>	Routing table information for a specific instance
label <value>	Destination label

Attribute	Description
mpls	Address family
prefix <value>	Destination prefix
source	Source of the routing information

### Example 1: List static routes information

```

supervisor@dev1: cfg> show route ipv4 source static
Instance: default, AFI: ipv4, SAFI: unicast
Prefix/Label          Source          Pref    Next Hop
Interface
198.51.100.100/24     static          2       198.51.100.22
ifl-0/0/1/4
supervisor@dev1: cfg>
    
```

### Example 2: List detailed static routes information

```

supervisor@dev1: cfg> show route ipv4 source static detail
Instance: default, AFI: ipv4, SAFI: unicast
198.51.100.100/24
  Source: static, Preference: 2
  Next Hop: 198.51.100.22
  Covering prefix: 198.51.100.22/24
  Next Hop type: direct, Next Hop action: None
  Resolved in: default-ipv4-unicast
  Egress interface: ifl-0/0/1/4, NextHop MAC: 7a:00:81:64:04:04
    
```

### Example 3: List MPLS route information

```

supervisor@rtbrick: cfg> show route mpls
Instance: default, AFI: mpls, SAFI: unicast
Prefix/Label    Source    Pref    Next Hop          Interface
20010           bgp       170     2001:db8:0:110::  ifl-0/0/17/1001
20011           bgp       170     2001:db8:0:110::  ifl-0/0/17/1001
20012           bgp       170     2001:db8:0:110::  ifl-0/0/17/1001
20013           bgp       170     2001:db8:0:110::  ifl-0/0/17/1001
20014           bgp       170     2001:db8:0:110::  ifl-0/0/17/1001
20015           bgp       170     2001:db8:0:110::  ifl-0/0/17/1001
20016           bgp       170     2001:db8:0:110::  ifl-0/0/17/1001
20017           bgp       170     2001:db8:0:110::  ifl-0/0/17/1001
20018           bgp       170     2001:db8:0:110::  ifl-0/0/17/1001
    
```

## 3. Layer 2 Services

### 3.1. L2X

#### 3.1.1. L2X Overview

Layer 2 Cross-Connect (L2X) is a data plane feature that connects two physical ports (IFPs) using Layer 2 switching. L2X can switch the traffic between two IFPs to provide the trunk service for an Ethernet switch.

#### Local and Remote L2X

Local L2X refers to an L2 connection between two ports or VLANs on the same device. In a local L2X, both interfaces are on the same router. The L2X can switch Layer 2 (frame) traffic between the ports. Based on the configuration, these cross connects can be uni-directional as well as bi-directional.

Remote L2X refers to L2 connection between two ports located on two different devices. In a remote L2X, the interfaces are located on two different routers and it requires an MPLS tunnel to transport the traffic between the two routers.

**Local L2X:** The following figure shows the Local L2X scenario.



**Remote L2X:** The following figure shows the remote L2X scenario.

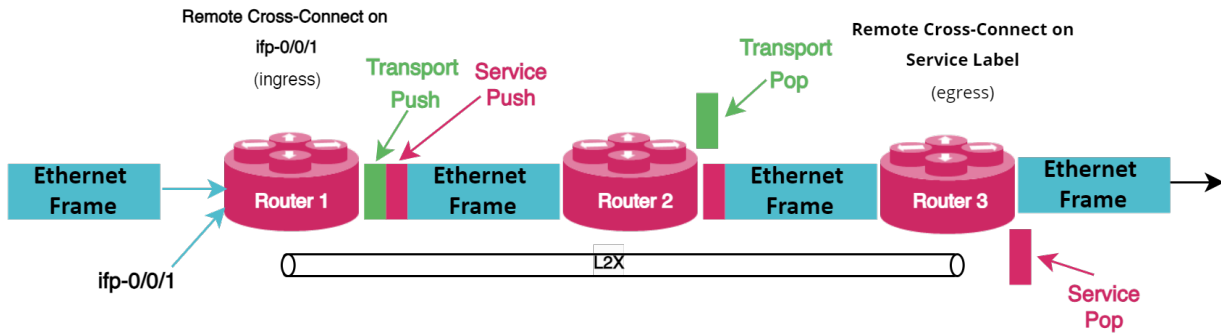

## Unidirectional and Bidirectional L2X

Unidirectional refers to data either sent or received in one direction and Bidirectional implies the flow of traffic between two routers in both directions.

The bidirectional cross connect feature helps you to establish cross connection between two local ports with an L2X configuration. Bi-directional attribute is applicable only to local cross connect. Bidirectional connectivity requires a pair of unidirectional L2X or a single bidirectional L2X.



The VLAN operations are not supported for bi-directional local cross-connect.

## Ingress and Egress in L2X

In L2X, ingress traffic is incoming traffic that enters the boundary of a network and egress traffic implies outgoing traffic that exits an entity or a network boundary.

## Port and VLAN Cross-connects

Both port and VLAN cross-connects switches Layer 2 traffic from input interface to output interface. A port cross-connect switches all Layer 2 traffic arriving at an input interface, but a VLAN cross-connect only switches the Layer 2 traffic associated with a specific VLAN. A port-based L2X indicates a port-only configuration, so there are no VLANs involved.

Both single-tag and double-tagged (inner and outer VLAN tags) are supported. The port and VLAN L2X support both local and remote L2X configurations. In remote L2X connections, the VLAN cross-connects are typically configured on the MPLS tunnel ingress router.

Untagged traffic on L2X interfaces is also supported. However, there is no way to

select only untagged traffic for cross-connecting. Therefore, only port cross connects are supported for untagged traffic.

## L2X 802.1ad Ethertype Support

RBFS supports VLAN operations such as VLAN add, VLAN swap, and VLAN delete on egress interface. RBFS supports similar functionality at the ingress side as well. That is, RBFS supports the following VLAN operations:

- Single-VLAN-Add with an option to configure encapsulation (that is, 802.1q or 802.1ad)
- Single-VLAN-Delete
- Swap-Outer-VLAN

By default the encapsulation method is 802.1q. If an encapsulation method is not specified, 802.1q is the default mode.

In addition to setting the Ethertype for a VLAN operation, the 802.1ad support includes that ingress traffic for all tagged match options will match on both Ethertype 0x8100 (802.1q) and 0x88a8 (802.1ad) by default.

## VLAN Operations

RBFS supports VLAN operations such as **VLAN add**, **VLAN swap** and **VLAN delete** on Ingress and Egress interfaces.

The current functionality has been extended to all the existing CLIs to accept ingress and egress VLAN operations and Ingress and Egress VLAN encapsulation values.

Both 802.1q and 802.1ad encapsulations are supported. The default encapsulation is 802.1q.

Traffic will be matched at ingress direction based on the match criterion. RtBrick Full Stack (RBFS) supports the following match parameters.

On a physical interface, there are five different match types. Traffic can be matched based on the following:

1. (ifp)

2. (ifp, outer\_vlan)
3. (ifp, outer\_vlan, inner\_vlan)
4. (ifp, outer\_vlan, any inner\_vlan)
5. (ifp, any vlan)

Some of the match types are mutually exclusive. For example, (ifp, outer\_vlan, inner\_vlan) and (ifp, outer\_vlan, any inner\_vlan) configuration on the same interface throws errors.

If **ifp, any vlan** match type is configured with any other match type, it will create conflicts.



The **match-type** attribute is mandatory for **match-untagged**, **match-any** and **match-inner-any** match criteria.

### Supported Match Type Validations

The following table shows the supported match type validations.



The asterisk \* indicates *any* or *no vlan* tags.

Cases	Configuration A	Configuration B	Support
<b>Case 1 : IFP A, *</b>	IFP A,*	IFP A, ov 10	No
	IFP A,*	IFP A, ov 10, iv 20	No
	IFP A,*	IFP A, ov 10, *	No
	IFP A,*	IFP A, untagged	No
<b>Case 2: IFP A, untagged</b>	IFP A, untagged	IFP A, *	No
	IFP A, untagged	IFP A, ov 10	Yes
	IFP A, untagged	IFP A, ov 30, iv 20	Yes
	IFP A, untagged	IFP A, ov 20, *	Yes

<b>Cases</b>	<b>Configuration A</b>	<b>Configuration B</b>	<b>Support</b>
<b>Case 3: IFP A, outer_vlan:</b>	IFP A, ov 10	IFP A, *	No
	IFP A, ov 10	IFP A, ov 10, *	No
	IFP A, ov 10	IFP A, ov 20	Yes
	IFP A, ov 10	IFP A, ov 10 , iv 20	No
	IFP A, ov 10	IFP A, ov 40 , iv 7	Yes
	IFP A, ov 10	IFP A, ov 30, *	Yes
	IFP A, ov 10	IFP A, untagged	Yes
<b>Case 4: IFP A, outer_vlan, inner_vlan:</b>	IFP A, ov 10, iv 20	IFP A, *	No
	IFP A, ov 10, iv 20	IFP A, ov 10, *	No
	IFP A, ov 10, iv 20	IFP A, ov 10	No
	IFP A, ov 10, iv 20	IFP A, ov 30	Yes
	IFP A, ov 10, iv 20	FP A, ov 20 , *	Yes
	IFP A, ov 10, iv 20	IFP A, untagged	Yes
	IFP A, ov 10, iv 20	IFP A, ov 10, iv 30	Yes
<b>Case 5: IFP A, outer_vlan, *</b>	IFP A, ov 10, *	IFP A, *	No
	IFP A, ov 10, *	IFP A, ov 10	No
	IFP A, ov 10, *	IFP A, ov 10, iv 20	No
	IFP A, ov 10, *	IFP A, ov 20, iv 7	Yes
	IFP A, ov 10, *	IFP A, ov 30	Yes
	IFP A, ov 10, *	IFP A, untagged	Yes
	IFP A, ov 10, *	IFP A, ov 40, *	Yes

## Supported Platforms

Not all features are necessarily supported on each hardware platform. Refer to the *Platform Guide* for the features and the sub-features that are or are not supported by each platform.

### 3.1.2. L2X Configuration



## Configuration Hierarchy

The diagram illustrates the L2X configuration hierarchy.

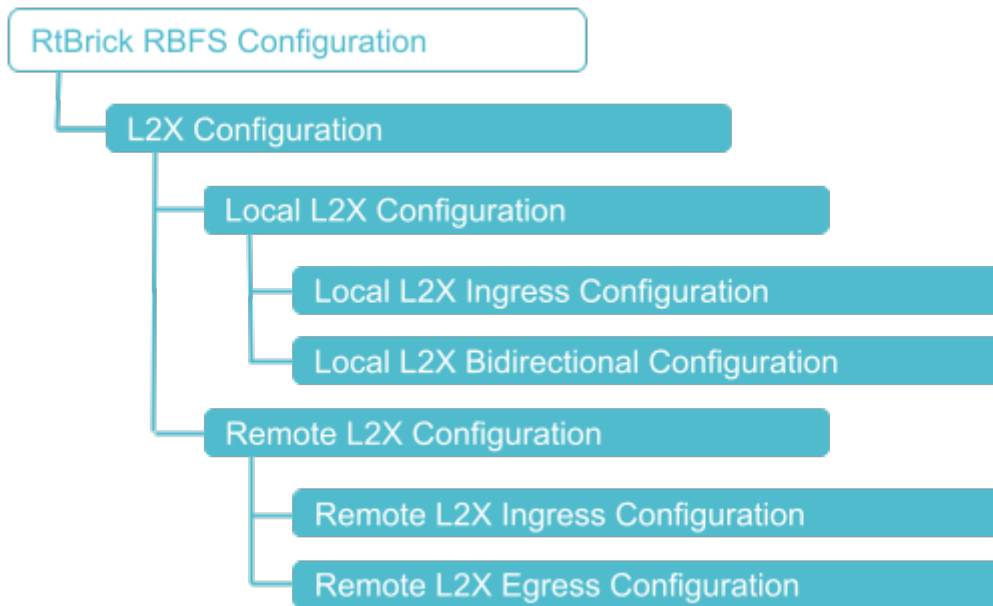

## Configuration Syntax and Commands

The following sections describe the L2X configuration syntax and commands.

### Local L2X Configuration

The following sections describe the Local L2X unidirectional and bidirectional configurations.

### Local L2X Ingress Configuration

This configuration enables local unidirectional L2X (Local Cross-Connect) on the same device.

#### Syntax:

**set l2x name** <l2x-name> **ingress** <attribute> <value>

Attribute	Description
<l2x-name>	Name of L2X
description <description>	(Optional) L2X description

Attribute	Description
egress-vlan-encapsulation <encapsulation>	(Optional) Egress VLAN encapsulation value. NOTE: This option can be configured only after 'swap-outer-vlan' configuration.
egress-vlan-operation <vlan-action>	(Optional) Outgoing VLAN operation
incoming-inner-vlan <vlan-id>	(Optional) Incoming inner VLAN
incoming-interface <incoming-interface>	(Mandatory) Incoming physical interface name
incoming-outer-vlan <vlan-id>	(Optional) Incoming outer VLAN
ingress-outer-vlan <vlan-id>	(Optional) Outer VLAN at ingress side
ingress-vlan-encapsulation <encapsulation>	(Optional) Ingress VLAN encapsulation value. NOTE: This option can be configured only after 'swap-outer-vlan' configuration.
ingress-vlan-operation <vlan-action>	(Optional) VLAN operation on ingress side outer VLAN
match-type <match-type>	(Mandatory) L2X match type
match-tp-id 802.1ad	The option enables L2X to recognize and handle packets tagged with 0x88a8 TPID, allowing interoperability with 802.1ad encapsulated traffic.
outgoing-interface <outgoing-interface>	(Mandatory) Outgoing physical interface name
outgoing-outer-vlan <vlan-id>	(Optional) Outgoing outer VLAN

### Example 1: Local L2X Ingress Configuration with Port Match

```
{
  "rtbrick-config:l2x": {
    "name": [
      {
        "name": "test1",
        "direction": "ingress",
        "incoming-interface": "ifp-0/1/64",
        "outgoing-interface": "ifp-0/1/66",

```

```

    "match-type": "match-any"
  }
]
}

```

### Example 2: Local L2X Ingress Configuration with VLAN Match

```

{
  "rtbrick-config:l2x": {
    "name": [
      {
        "name": "test4",
        "direction": "ingress",
        "incoming-interface": "ifp-0/1/12",
        "incoming-outer-vlan": 200,
        "outgoing-interface": "ifp-0/1/13",
        "match-type": "match-outer"
      }
    ]
  }
}

```

### Example 3: Local L2X Ingress VLAN Operations

```

{
  "rtbrick-config:l2x": {
    "name": [
      {
        "name": "test4",
        "direction": "ingress",
        "incoming-interface": "ifp-0/1/12",
        "incoming-outer-vlan": 200,
        "outgoing-interface": "ifp-0/1/13",
        "match-type": "match-outer",
        "ingress-vlan-operation": "single-vlan-add",
        "ingress-outer-vlan": 400
      }
    ]
  }
}

```

### Example 4: Local L2X Configuration with 0x88a8 TPID tagged packets.

```

"rtbrick-config:l2x": {
  "name": [
    {
      "name": "local_1",
      "direction": "ingress",
      "incoming-interface": "ifp-0/0/3",
      "incoming-outer-vlan": 100,
      "outgoing-interface": "ifp-0/0/22",
      "egress-vlan-operation": "swap-outer-vlan",
      "outgoing-outer-vlan": 100,

```

```

    "egress-vlan-encapsulation": "802.1ad",
    "match-type": "match-outer",
    "ingress-vlan-operation": "single-vlan-delete",
    "match-tp-id": "802.1ad"
  }
]
},

```

### Local L2X Bidirectional Configuration

This configuration enables redirecting traffic incoming (ingress) on a particular interface to another interface and vice versa on the same hardware device.

**Syntax:**

**set l2x name** <l2x-name> **bi-directional** <attribute> <value>

Attribute	Description
match-type <match-type>	(Mandatory) Match types with which traffic can be matched.
incoming-interface <incoming-interface>	(Mandatory) Incoming interface is where the traffic originates from.
outgoing-interface <outgoing-interface>	(Mandatory) Outgoing interface where the traffic is going to.
description <description>	(Optional) L2X description
egress-vlan-encapsulation <encapsulation>	(Optional) Egress VLAN encapsulation
incoming-inner-vlan <vlan-id>	(Optional) Incoming inner VLAN
incoming-outer-vlan <vlan-id>	(Optional) Incoming outer VLAN
ingress-outer-vlan <vlan-id>	(Optional) Outer VLAN at ingress side
ingress-vlan-encapsulation <encapsulation>	(Optional) Ingress VLAN encapsulation
outgoing-outer-vlan <vlan-id>	(Optional) Outgoing outer VLAN

Example 1: Local L2X Bidirectional Configuration

```

{
  "rtbrick-config:l2x": {
    "name": [
      {
        "name": "test2",
        "direction": "bi-directional",
        "incoming-interface": "ifp-0/1/64",
        "outgoing-interface": "ifp-0/1/66",
        "match-type": "match-untagged"
      }
    ]
  }
}

```

## Local L2X VLAN Operation Configuration

This configuration enables VLAN operations for both ingress and egress traffic on a particular interface to another interface and vice versa on the same hardware device.

### Syntax:

**set l2x name** <l2x-name> **ingress** [**egress-vlan-operation** | **ingress-vlan-operation**] <attribute> <value>

Attribute	Description
<l2x-name>	Name of the l2x.
double-vlan-add	Adds two VLAN tags (QinQ tagging) to the packet.
double-vlan-delete	Removes two VLAN tags from the packet.
single-vlan-add	Adds a single VLAN tag to the packet.
single-vlan-delete	Removes a single VLAN tag from the packet.
swap-outer-vlan	Replaces the outer VLAN tag with a new one.

## Remote L2X Configuration

The following sections describe the remote L2X configurations.

### Remote L2X Ingress Configuration

This configuration enables the remote L2X ingress side.

### Syntax:

**set l2x name** <l2x-name> **ingress** <attribute> <value>

Attribute	Description
match-type <match-type>	(Mandatory) Match types with which traffic can be matched.
incoming-interface <incoming-interface>	(Mandatory) Incoming interface is where the traffic originates from.
ingress-vlan-operation <ingress-vlan-action>	(Optional) VLAN operation on ingress side outer VLAN
ingress-outer-vlan <vlan-id>	(Optional) Outer VLAN at ingress side
ingress-vlan-encapsulation <encapsulation>	(Optional) Ingress VLAN encapsulation value
nexthop4/nexthop6 <nexthop>	(Mandatory) Next-Hop address
lookup-instance <lookup-instance>	(Optional) Instance name
lookup-afi <lookup-afi>	(Optional) AFI value: ipv4 or ipv6
lookup-safi <lookup-safi>	(Optional) SAFI value: safi values are unicast, labeled-unicast
service-label <service_label>	(Mandatory) Service label value. NOTE: Supported MPLS label values are 0 - 1048575. The reserved MPLS label range is 0 - 15. In RBFS, BGP uses the label range 20000 - 100000. It is recommended to assign label values outside of these reserved ranges to avoid conflicts.

Example 1: Remote L2X Ingress Configuration with Port Match

```

{
  "rtbrick-config:l2x": {
    "name": [
      {
        "name": "test8",
        "direction": "ingress",
        "incoming-interface": "ifp-0/1/64",
        "nexthop4": "198.51.100.44",
        "lookup-instance": "default",
        "lookup-afi": "ipv4",
        "lookup-safi": "labeled-unicast",

```

```

    "service-label": 10000,
    "match-type": "match-any"
  }
]
}
}

```

### Example 2: Remote L2X Ingress Configuration with VLAN match

```

{
  "rtbrick-config:l2x": {
    "name": [
      {
        "name": "test4",
        "direction": "ingress",
        "incoming-interface": "ifp-0/1/12",
        "incoming-outer-vlan": 100,
        "incoming-inner-vlan": 200,
        "nexthop4": "198.51.100.44",
        "lookup-instance": "default",
        "lookup-afi": "ipv4",
        "lookup-safi": "labeled-unicast",
        "service-label": 8000,
        "match-type": "match-outer-inner"
      }
    ]
  }
}

```

### Example 3: Remote L2X Ingress VLAN operations

```

{
  "rtbrick-config:l2x": {
    "name": [
      {
        "name": "test4",
        "direction": "ingress",
        "incoming-interface": "ifp-0/1/12",
        "incoming-outer-vlan": 100,
        "incoming-inner-vlan": 200,
        "nexthop4": "198.51.100.44",
        "lookup-instance": "default",
        "lookup-afi": "ipv4",
        "lookup-safi": "labeled-unicast",
        "service-label": 10000,
        "match-type": "match-outer-inner",
        "ingress-vlan-operation": "Single-Vlan-Delete"
      }
    ]
  }
}

```

## Remote L2X Egress Configuration

This configuration enables the remote L2X egress side.

**Syntax:**

**set l2x name** <l2x-name> **egress** <attribute> <value>

Attribute	Description
service-label <service_label>	(Mandatory) Service label value. NOTE: Supported MPLS label values are 0 - 1048575. The reserved MPLS label range is 0 - 15. In RBFS, BGP uses the label range between 20000 - 100000. It is recommended to assign a label value outside of these reserved ranges to avoid conflicts.
outgoing-interface <outgoing-interface>	(Mandatory) Interface where traffic is going to.
egress-vlan-operation <vlan-action>	(Optional) Outgoing VLAN operation
outgoing-outer-vlan <vlan-id>	(Optional) Outgoing outer VLAN

**Example 1: Local L2X Egress Configuration**

```
{
  "rtbrick-config:l2x": {
    "name": [
      {
        "name": "test4",
        "direction": "egress",
        "service-label": 10000,
        "outgoing-interface": "ifp-0/1/66"
      }
    ]
  }
}
```

**Example 2: Local L2X Egress Configuration with VLAN Operation**

```
{
  "rtbrick-config:l2x": {
    "name": [
      {
        "name": "test4",
        "direction": "egress",
        "service-label": 10000,
        "outgoing-interface": "ifp-0/1/12",
        "egress-vlan-operation": "single-vlan-add",
        "outgoing-outer-vlan": 400
      }
    ]
  }
}
```



```

    ]
  }
}

```

### 3.1.3. L2X Operational Commands

The L2X show commands provide detailed information about the L2X operations.

#### L2X Show Commands

The L2X show commands display data from FIB local table. Therefore, local L2X with down ports or remote l2x with unresolved nexthop address are not displayed.

#### L2X Summary

The summary commands display L2X information in a tabular format. Key information is displayed in the summary output.



The L2X name is truncated after certain length as space is less to display summary output. In such cases, you can use detail command output where full name is displayed.

#### Syntax:

**show l2x** <options>

Option	Description
-	Without any option, the commands displays all L2X information such as ingress L2X and egress L2X.
l2x-name <l2x-name>	Displays information for a specific L2X.
detail	Displays detailed L2X information for a specific L2X.
direction <direction>	Displays L2X information for a specified direction, where direction can be ingress, egress, or bi-directional.
local-interface <interface-name>	Displays L2X information for a specific LAG interface.
nexthop4 <nexthop>	Displays L2X information for the remote IPv4 address.
nexthop6 <nexthop>	Displays L2X information for the remote IPv6 address.

Option	Description
service-label <service_label>	Displays the L2X information for a specific service label.
type <type>	Displays detailed L2X information for a specific type and L2X.
statistics	Displays statistics for a specific L2X.

### Example 1: Summary view of L2X information

```

supervisor@rtbrick: op> show l2x
Name                               Direction  Incoming Intf      Outgoing Intf/Next Hop  Outer VLAN
Inner VLAN      Service label
12bsa-0/1/27/281479271677953 ingress    ifp-0/1/27        2001:db8:0:75::        64
Any              110011
12bsa-0/1/27/281479271677953 egress    -                  ifp-0/1/27            -
120011
12bsa-0/1/27/281479271677954 ingress    ifp-0/1/27        2001:db8:0:75::        65
110012
12bsa-0/1/27/281479271677954 egress    -                  ifp-0/1/27            -
120012
12bsa-0/1/27/281479271677955 ingress    ifp-0/1/27        2001:db8:0:75::        66
110013
12bsa-0/1/27/281479271677955 egress    -                  ifp-0/1/27            -
120013
12bsa-0/1/27/281479271677956 ingress    ifp-0/1/27        2001:db8:0:75::        67
110014
12bsa-0/1/27/281479271677956 egress    -                  ifp-0/1/27            -
120014
    
```

### Example 2: Summary view of a specific L2X

```

supervisor@rtbrick: op> show l2x 12bsa-0/1/27/281479271677953
Name                               Direction  Incoming Intf      Outgoing Intf/Next Hop  Outer VLAN
Inner VLAN      Service label
12bsa-0/1/27/281479271677953 ingress    ifp-0/1/27        2001:db8:0:75::        64
110011
12bsa-0/1/27/281479271677953 egress    -                  ifp-0/1/27            -
120011
    
```

### Example 3: Summary view of a remote L2X

```

supervisor@rtbrick: op> show l2x type remote
Name                               Direction  Incoming Intf      Outgoing Intf/Next Hop  Outer VLAN
Inner VLAN      Service label
12bsa_lag-1_11 ingress    lag-1              2001:db8:0:85::        11
120011
12bsa_lag-1_11 egress    -                  lag-1                  -
110011
12bsa_lag-1_12 ingress    lag-1              2001:db8:0:85::        12
120012
12bsa_lag-1_12 egress    -                  lag-1                  -
110012
12bsa_lag-1_13 ingress    lag-1              2001:db8:0:85::        13
120013
12bsa_lag-1_13 egress    -                  lag-1                  -
110013
12bsa_lag-1_14 ingress    lag-1              2001:db8:0:85::        14
120014
    
```

```

12bsa_lag-1_14          egress -          lag-1          -          -
110014
12bsa_lag-1_15          ingress lag-1          2001:db8:0:85:: 15         Any
120015
12bsa_lag-1_15          egress -          lag-1          -          -
110015
12bsa_lag-1_16          ingress lag-1          2001:db8:0:85:: 16         Any
120016
    
```

#### Example 4: Summary view of L2X for a specific service label

```

supervisor@rtbrick: op> show l2x service-label 120011
Name          Direction Incoming Intf      Outgoing Intf/Next Hop  Outer VLAN  Inner
VLAN          Service label
12bsa_lag-1_11 ingress   lag-1              2001:db8:0:85::       11          Any
120011
supervisor@rtbrick: op>
    
```

#### Example 5: Summary view of the L2X information for a specified direction, where direction can be ingress, egress, or bi-directional.

```

supervisor@rtbrick: op> show l2x direction ingress
Name          Direction Incoming Intf      Outgoing Intf/Next Hop  Outer VLAN
Inner VLAN    Service label
12bsa_lag-1_11 ingress   lag-1              2001:db8:0:85::       11          Any
120011
12bsa_lag-1_12 ingress   lag-1              2001:db8:0:85::       12          Any
120012
12bsa_lag-1_13 ingress   lag-1              2001:db8:0:85::       13          Any
120013
12bsa_lag-1_14 ingress   lag-1              2001:db8:0:85::       14          Any
120014
12bsa_lag-1_15 ingress   lag-1              2001:db8:0:85::       15          Any
120015
12bsa_lag-1_16 ingress   lag-1              2001:db8:0:85::       16          Any
120016
12bsa_lag-1_17 ingress   lag-1              2001:db8:0:85::       17          Any
120017
12bsa_lag-1_18 ingress   lag-1              2001:db8:0:85::       18          Any
120018
12bsa_lag-1_19 ingress   lag-1              2001:db8:0:85::       19          Any
120019
12bsa_lag-1_20 ingress   lag-1              2001:db8:0:85::       20          Any
120020
12bsa_lag-1_21 ingress   lag-1              2001:db8:0:85::       21          Any
120021
12bsa_lag-1_22 ingress   lag-1              2001:db8:0:85::       22          Any
120022
12bsa_lag-1_23 ingress   lag-1              2001:db8:0:85::       23          Any
120023
12bsa_lag-1_24 ingress   lag-1              2001:db8:0:85::       24          Any
120024
12bsa_lag-1_25 ingress   lag-1              2001:db8:0:85::       25          Any
120025
12bsa_lag-1_26 ingress   lag-1              2001:db8:0:85::       26          Any
120026
12bsa_lag-1_27 ingress   lag-1              2001:db8:0:85::       27          Any
120027
    
```

#### Example 6: Summary view of L2X information for a specific LAG interface

```

supervisor@rtbrick: op> show l2x local-interface lag-1
Name          Direction Incoming Intf      Outgoing Intf/Next Hop  Outer VLAN
Inner VLAN    Service label
    
```

12bsa_lag-1_11		ingress	lag-1	2001:db8:0:85::	11
Any	120011				
12bsa_lag-1_12		ingress	lag-1	2001:db8:0:85::	12
Any	120012				
12bsa_lag-1_13		ingress	lag-1	2001:db8:0:85::	13
Any	120013				
12bsa_lag-1_14		ingress	lag-1	2001:db8:0:85::	14
Any	120014				
12bsa_lag-1_15		ingress	lag-1	2001:db8:0:85::	15
Any	120015				
12bsa_lag-1_16		ingress	lag-1	2001:db8:0:85::	16
Any	120016				
12bsa_lag-1_17		ingress	lag-1	2001:db8:0:85::	17
Any	120017				
12bsa_lag-1_18		ingress	lag-1	2001:db8:0:85::	18
Any	120018				
12bsa_lag-1_19		ingress	lag-1	2001:db8:0:85::	19
Any	120019				
12bsa_lag-1_20		ingress	lag-1	2001:db8:0:85::	20
Any	120020				

### Example 7: Summary view of L2X information for a remote egress router

```
supervisor@rtbrick: op> show l2x nexthop4 198.51.100.103
```

Name	Direction	Incoming Intf	Outgoing Intf/Next Hop	Outer VLAN
Inner VLAN	Service label			
12bsa_lag-1_11	ingress	lag-1	198.51.100.103	11
120011				Any
12bsa_lag-1_12	ingress	lag-1	198.51.100.103	12
120012				Any
12bsa_lag-1_13	ingress	lag-1	198.51.100.103	13
120013				Any
12bsa_lag-1_14	ingress	lag-1	198.51.100.103	14
120014				Any
12bsa_lag-1_15	ingress	lag-1	198.51.100.103	15
120015				Any
12bsa_lag-1_16	ingress	lag-1	198.51.100.103	16
120016				Any

### Example 8: Summary view of L2X information for a remote egress router

```
supervisor@rtbrick: op> show l2x nexthop6 2001:db8:0:85::
```

Name	Direction	Incoming Intf	Outgoing Intf/Next Hop	Outer VLAN
Inner VLAN	Service label			
12bsa_lag-1_11	ingress	lag-1	2001:db8:0:85::	11
120011				Any
12bsa_lag-1_12	ingress	lag-1	2001:db8:0:85::	12
120012				Any
12bsa_lag-1_13	ingress	lag-1	2001:db8:0:85::	13
120013				Any
12bsa_lag-1_14	ingress	lag-1	2001:db8:0:85::	14
120014				Any
12bsa_lag-1_15	ingress	lag-1	2001:db8:0:85::	15
120015				Any
12bsa_lag-1_16	ingress	lag-1	2001:db8:0:85::	16
120016				Any
12bsa_lag-1_17	ingress	lag-1	2001:db8:0:85::	17
120017				Any
12bsa_lag-1_18	ingress	lag-1	2001:db8:0:85::	18
120018				Any
12bsa_lag-1_19	ingress	lag-1	2001:db8:0:85::	19
120019				Any
12bsa_lag-1_20	ingress	lag-1	2001:db8:0:85::	20
120020				Any
12bsa_lag-1_21	ingress	lag-1	2001:db8:0:85::	21
120021				Any

## Example 9: L2X information in detailed format

```

supervisor@rtbrick: op> show l2x detail
L2X name: l2bsa_lag-1_11
  Direction: ingress
  Status: Download success
  Incoming interface: lag-1
  Service label: 120011
  Subtype: Incoming Port - Outer Vlan - Any Inner Vlan Match
  Incoming outer VLAN: 11
  Incoming inner VLAN: Any
  Ingress vlan operation:
    Vlan operation: Swap-Outer-Vlan
    Outer vlan: 64
  NextHop:
    NextHop IP: 2001:db8:0:85::
    Lookup instance: default
    Lookup AFI: ipv6
    Lookup SAFI: labeled-unicast
    NextHop type: Remote ingress cross connect
    NextHop action: mpls label push
  Egress vlan operation:

```

## Example 10: Detailed L2X information for a specific L2X

```

supervisor@rtbrick: op> show l2x test1 detail
L2X name: test1
  Direction: ingress
  Status: Download success
  Incoming interface: ifp-0/0/4
  Outgoing interface: ifp-0/0/10
  Subtype: Incoming Port - Any Vlan Match
  Incoming outer VLAN: Any
  Incoming inner VLAN: Any
  Ingress vlan operation:
  NextHop:
    NextHop type: Local egress cross connect
    NextHop action: No vlan manipulation - l2 forward
  Egress vlan operation:

```

## Example 11: Detailed L2X information for a specific type and L2X

```

supervisor@rtbrick: op> show l2x type local test1 detail
L2X name: test1
  Direction: ingress
  Status: Download success
  Incoming interface: ifp-0/0/4
  Outgoing interface: ifp-0/0/10
  Subtype: Incoming Port - Any Vlan Match
  Incoming outer VLAN: Any
  Incoming inner VLAN: Any
  Ingress vlan operation:
  NextHop:
    NextHop type: Local egress cross connect
    NextHop action: No vlan manipulation - l2 forward

```

Egress vlan operation:

## Example 12: Detailed L2X information for a specific direction and L2X

```

supervisor@rtbrick: op> show l2x direction egress test2 detail
L2X name: test2
  Direction: egress
  Status: Download success
  Outgoing interface: ifp-0/0/4
  Service label: 1234
  Subtype: Service Label Match
  Incoming outer VLAN: -
  Incoming inner VLAN: -
  Ingress vlan operation:
  NextHop:
    NextHop type: Remote egress cross connect
    NextHop action: No vlan manipulation - l2 forward
  Egress vlan operation:
    
```

## Example 13: Statistics for all installed L2X

```

supervisor@rtbrick: op> show l2x statistics

L2X Name: l2x-test1/0
  Physical Interface Name: ifp-0/0/4
  Logical Interface Type: L2x ingress vlan interface
  Port-Mapping-Core: 0
  Vlan-Port-ID: 1149251592
  MPLS-Port-ID: N/A
  Counters:
    In-Forward-Packets: 57
    In-Forward-Bytes: 5700
    In-Drop-Packets: 0
    In-Drop-Bytes: 0
    Out-Forward-Packets: 0
    Out-Forward-Bytes: 0
    Out-Drop-Packets: 0
    Out-Drop-Bytes: 0
L2X Name: l2x-d3b529d74770f91fb2acf5e38da70eb9213473dd7e996c6a
  Physical Interface Name: ifp-0/0/10
  Logical Interface Type: L2x egress vlan interface
  Port-Mapping-Core: 0
  Vlan-Port-ID: 1149251591
  MPLS-Port-ID: N/A
  Counters:
    In-Forward-Packets: 0
    In-Forward-Bytes: 0
    In-Drop-Packets: 0
    In-Drop-Bytes: 0
    Out-Forward-Packets: 0
    Out-Forward-Bytes: 0
    Out-Drop-Packets: 0
    Out-Drop-Bytes: 0
    
```

## L2X Clear Commands

Clear commands allow to reset operational states.

### L2X Statistics

This commands resets L2X statistics.

Syntax:

**clear l2x statistics** <l2x-name>

Attribute	Description
-	Without any option, the command clears all L2X statistics.
<l2x-name>	L2X name.

Example:

```
supervisor@rtbrick: op> clear l2x statistics l2x-test1/0
```

## 3.2. EVPN-VPWS

### 3.2.1. EVPN-VPWS Overview

Ethernet Virtual Private Network (EVPN) is a Layer 2 internetworking technology similar to BGP/MPLS IP VPN. EVPN uses extended BGP reachability information and advertisements between different Layer 2 networks at various sites in the control plane.

The EVPN Virtual Private Wire Service (VPWS) is a point-to-point (P2P) service that is built on the EVPN service architecture. EVPN-VPWS uses MPLS tunnels to traverse the backbone network. It offers a Layer 2 packet forwarding mode that connects access circuits (ACs) as per the specifications of RFC 8214.

### Supported Standards

RFC Number	Description
7432	BGP MPLS-Based Ethernet VPN

RFC Number	Description
8214	Virtual Private Wire Service Support in Ethernet VPN

## EVPN VPWS Network Model

As shown in the figure below, an EVPN VPWS network contains the following building blocks:

- Customer edge (CE)—Customer device directly connected to the service provider network.
- Provider edge (PE)—Service provider device connected to CEs. PEs provide access to the EVPN VPWS network and forward traffic between customer network sites by using public tunnels.
- Attachment circuit (AC)—A physical or virtual link between a CE and a PE.
- Pseudowire (PW)—A virtual bidirectional connection between two PEs. A PW comprises a pair of virtual links in opposite directions.
- MPLS transport tunnel—A connection that carries one or more PWs across the MPLS core or IP backbone, such as an MPLS tunnel.
- Cross-connect—A connection formed by two physical or virtual circuits, such as ACs and PWs, that switches packets between them.

The figure below shows the protocol packet exchange process in the EVPN VPWS.

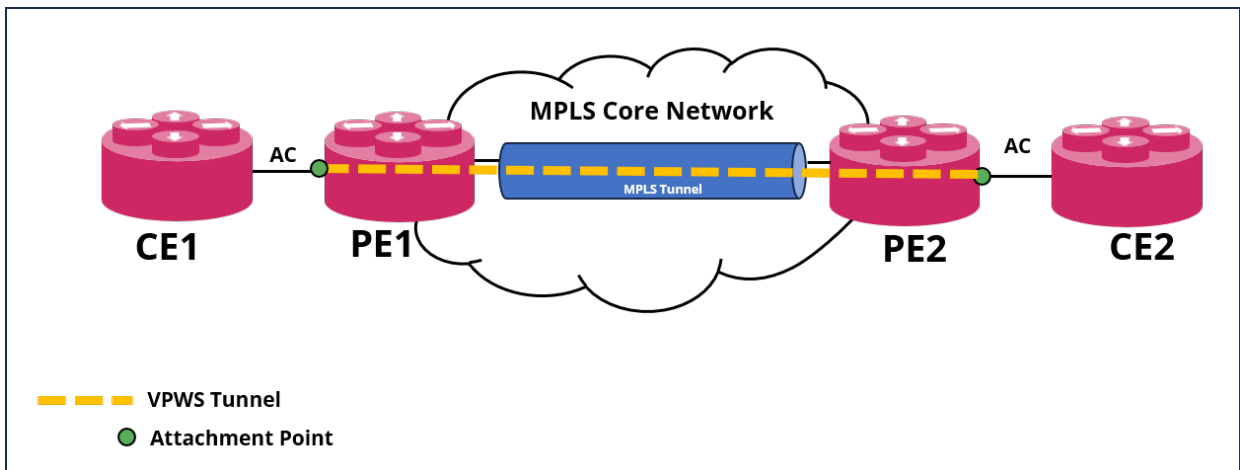

PE1 and PE2 are each configured with an EVPN VPWS instance. After the PE receives packets from the AC, it adds the PW label and sends them to the peer PE through the MPLS label-switched path (LSP). After the other PE (PE2) receives the packet via the MPLS LSP, it pops the PW label of the packets and forwards the



packets to the AC bound to the PW.

## VLAN Tag Manipulation

VLAN Tag Manipulation involve modifying VLAN tags on Ethernet frames to ensure proper traffic segmentation and delivery across a Layer 2 network. RBFS supports some VLAN Tag Manipulation operations which are used to manipulate tags on Ethernet frames as they enter or leave a network interface. These manipulations include adding, removing, and rewriting VLAN tags. VLAN manipulation operations can be performed both at ingress and egress nodes.

The following VLAN manipulation operations are supported for Layer 2 VPN interfaces:

- **push**: Adds a single outer VLAN tag to an Ethernet frame.
- **pop**: Removes a single outer VLAN tag from an Ethernet tag frame.
- **swap**: Rewrite a single outer VLAN tag of an Ethernet tag frame.
- **push-push**: Adds two VLAN tags to an Ethernet frame.
- **pop-pop**: Removes two VLAN tags from an Ethernet tags frame.
- **swap-swap**: Rewrite both the outer and inner VLAN tags of an Ethernet tags frame.
- **swap-push**: Rewrite the outer VLAN tag and add a new inner VLAN tag for Ethernet tags' frame.
- **pop-swap**: Removes the outer VLAN tag and rewrites the inner VLAN tag of an Ethernet tags' frame.

### Supported CLI Options for VLAN Tag Manipulation Operations

The following table presents the various VLAN tag manipulation operations and supported CLI options.

CLI Options	pop	push	swap	push-push	pop-pop	swap-push	swap-swap	pop-swap
vlan-id	No	Yes	Yes	Yes	No	Yes	Yes	Yes
vlan-encapsulation	No	Yes	Yes	Yes	No	Yes	Yes	Yes
innervlan-id	No	No	No	Yes	No	Yes	Yes	No

## Supported Platforms

Not all features are necessarily supported on each hardware platform. Refer to the *Platform Guide* for the features and the sub-features that are or are not supported by each platform.



Currently, the following features are not supported for EVPN VPWS:

- Policy filtering options (at Address Family/Peer-Group/Instance levels)
- LAG interface as an attachment circuit
- LAG interface as an LSP MPLS path
- Route Reflection
- Add-Path
- VLAN change configuration on L2 IFL

### 3.2.2. EVPN VPWS Configuration

#### Configuration Hierarchy

The diagram illustrates the EVPN-VPWS configuration hierarchy. All EVPN VPWS configurations are done within an instance, such as the default instance or an EVPN service instance.

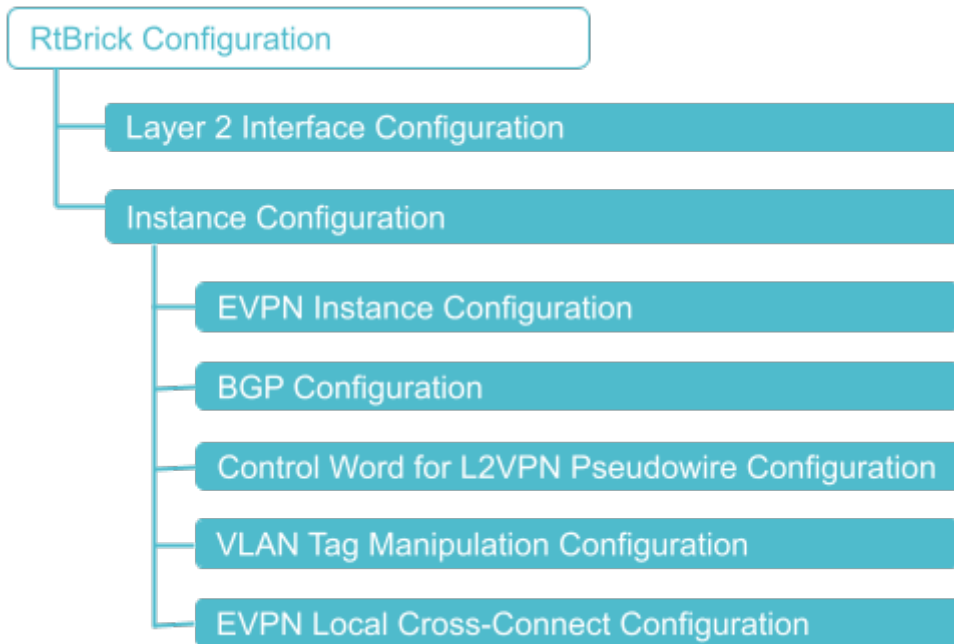

## Configuration Syntax and Commands

The following sections describe the EVPN-VPWS configuration syntax and commands.

### Layer 2 Interface Configuration

EVPN-VPWS supports the configuration of Layer 2 logical interfaces.

#### Syntax:

**set interface** <name> <attribute> <value>

Attribute	Description
<name>	Specify the name of the interface. Example: ifp-0/0/1.
unit <unit-id>	Create a logical interface (also referred to as a sub-interface) under the physical interface
unit <unit-id> interface-type l2vpn-vpws	Specify the type of the L2VPN interface.

Attribute	Description
unit <unit-id> match-type port	Sets the "port" match-type for the L2VPN VPWS untagged interfaces. For tagged interfaces, "port" match-type is not supported. Ensure that there are no other tagged configurations for the interfaces when the port match-type is configured. When port matching is configured, it will match all traffic regardless of whether it is untagged, single-tagged, or double-tagged VLANs.
unit <unit-id> vlan <outer-vlan-id>	Outer VLAN ID.
unit <unit-id> vlan <inner-vlan-id>	Inner VLAN ID.
unit <unit-id> instance <instance>	Assign the logical interface to an instance.

The following example shows an untagged interface configuration along with "port" match-type for the L2VPN VPWS untagged interface.

```
set interface ifp-0/0/17 unit 0
set interface ifp-0/0/17 unit 0 interface-type l2vpn-vpws
set interface ifp-0/0/17 unit 0 match-type port
set interface ifp-0/0/17 unit 0 instance evpn-vpws-vrf1
commit
```

The following example shows a single-tagged interface configuration.

```
set interface ifp-0/0/17 unit 100
set interface ifp-0/0/17 unit 100 interface-type l2vpn-vpws
set interface ifp-0/0/17 unit 100 instance evpn-vpws-vrf2
set interface ifp-0/0/17 unit 100 vlan 100
commit
```

The following example shows a double-tagged interface configuration.

```
set interface ifp-0/0/17 unit 200
set interface ifp-0/0/17 unit 200 interface-type l2vpn-vpws
set interface ifp-0/0/17 unit 200 instance evpn-vpws-vrf3
set interface ifp-0/0/17 unit 200 vlan 200
set interface ifp-0/0/17 unit 200 inner-vlan 201
commit
```

## EVPN Instance Configuration

An EVPN Instance (EVI) is a routing and forwarding instance of EVPN that covers all the participating PE routers in a VPN. EVI is configured per customer on the PE routers. Each EVI has a unique route distinguisher and one or more route targets.

### Syntax:

**set instance** <name> <attribute> <value>

Attribute	Description
<name>	A unique name for the EVPN routing instance.
address-family <afi>	Address family identifier (AFI). Supported value: l2vpn
address-family <afi> <safi>	Subsequent address family identifier (SAFI). Supported values: evpn-vpws  <div style="display: flex; align-items: center;">  <span style="color: red;">evpn-vpws</span> needs to be enabled on the VRF instance.         </div>
protocol	Specifies the routing protocol
route-distinguisher <as-number   ipv4-address:id>	The route distinguisher (RD) uniquely defines routes within an IPv4 network. PE routers use route distinguishers to identify which VPN a packet belongs to. Supported formats are <as-number:id> or <ipv4-address:id>.
ipv4-router-id <ipv4-router-id>	The router ID of the routing instance.
route-target ( import   export ) <rt-value>	Route targets (RT) are used to transfer routes between VPN instances. The RT identifies a subset of routes that should be imported to or exported from a particular VPN instance. You can configure an RT for importing or exporting routes or both.

In the following configuration, VRF instance AFI has been set to AFI: l2vpn and SAFI: evpn-vpws.

```
set instance evpn-vpws-vrf1
set instance evpn-vpws-vrf1 ipv4-router-id 192.1.6.3
set instance evpn-vpws-vrf1 route-distinguisher 192.1.6.3:65006
set instance evpn-vpws-vrf1 address-family l2vpn evpn-vpws
```

```
set instance evpn-vpws-vrf1 address-family l2vpn evpn-vpws route-target import
target:192.1.1.6.0:65006
set instance evpn-vpws-vrf1 address-family l2vpn evpn-vpws route-target export
target:192.1.1.6.0:65006
commit
```

## BGP Configuration

### BGP L2VPN VFT (Virtual Forwarding Table) Configuration

#### Syntax:

**set instance** <name> **protocol bgp** <attribute> <value>

Attribute	Description
<name>	Name of the routing instance
address-family <afi>	Address family identifier (AFI). Supported value: l2vpn
address-family <afi> <safi>	Subsequent address family identifier (SAFI). Supported value: evpn-vpws
	 <b>evpn-vpws</b> needs to be enabled on the VRF instance.
local-as <as-number>	The AS number in four-byte format. The numbers allowed are from 1 to 4294967285.
interface <name>	Interface that is bound to L2VPN
interface <name> local-service-id <local-service-id>	Specify the local service ID that is used to establish an EVPN PW between two PEs
interface <name> remote-service-id <remote-service-id>	Specify the remote service ID that is used to establish an EVPN PW between two PEs

The following example configures **evpn-vpws-vrf1** instance for BGP L2VPN.

```
set instance evpn-vpws-vrf1 protocol bgp local-as 65006
set instance evpn-vpws-vrf1 protocol bgp address-family l2vpn evpn-vpws
set instance evpn-vpws-vrf1 protocol bgp address-family l2vpn evpn-vpws interface
ifl-0/0/17/0
set instance evpn-vpws-vrf1 protocol bgp address-family l2vpn evpn-vpws interface
ifl-0/0/17/0 local-service-id 100
set instance evpn-vpws-vrf1 protocol bgp address-family l2vpn evpn-vpws interface
ifl-0/0/17/0 remote-service-id 101
```

```
commit
```

## BGP L2VPN EVPN Configuration

### Configuring the BGP L2VPN EVPN Address Family

#### Syntax:

**set instance** <name> **protocol bgp address-family l2vpn evpn**

Attribute	Description
<name>	Name of the routing instance

To configure BGP L2VPN EVPN on the default instance, enter the following command:

```
set instance default protocol bgp address-family l2vpn evpn
commit
```

### Configuring Address Families for Peer Groups

#### Syntax:

**set instance** <instance-name> **protocol bgp peer-group** <pg-name> **address-family** <afi> <safi> <attribute> <value>

Attribute	Description
<afi>	Address family identifier (AFI). Supported value: l2vpn.
<safi>	Subsequent address family identifier (SAFI). Supported value: evpn
extended-next-hop	Enable extended-next-hop encoding for BGP peer groups to allow the transfer of IPv4 prefixes over an IPv6 connection.
update-next-hop ( ipv4-address   ipv6-address ) <address>	BGP nexthop address for routes advertised to this peer group

To configure BGP L2VPN Peer Group on the **default** instance, enter the following command:

```
set instance default protocol bgp peer-group spine address-family l2vpn evpn
commit
```

### Configuring Control Word for L2VPN Pseudowire

In a network with EVPN-VPWS service, a control word can be inserted between the label stack and the MPLS payload. Control word is disabled by default.

**Syntax:**

**set instance** <name> **protocol bgp address-family l2vpn evpn-vpws interface** <interface> **control-word enable**

Attribute	Description
<name>	Name of the routing instance.
<interface>	Name of the interface.

To enable Control Word on the **default** instance, enter the following command:

```
set instance default protocol bgp peer-group spine address-family l2vpn evpn-vpws
interface if1-0/0/1/10 control-word enable
commit
```

### Configuring VLAN Tag Manipulation

The following section describes the VLAN tag manipulation configuration syntax and commands.

**Syntax:**

**set interface** <interface-name> **unit** <unit id> [**input-vlan-map** | **output-vlan-map**] <attribute> <value>

Attribute	Description
<name>	Specify the name of the interface.
unit <unit-id>	Specify the unit ID for the interface.
unit <unit-id> input-vlan-map	Ingress VLAN mapping.



Attribute	Description
unit <unit-id> output-vlan-map	Egress VLAN mapping
vlan-operation	Specify any of the VLAN operations supported: <b>pop</b> , <b>pop-pop</b> , <b>pop-swap</b> , <b>push</b> , <b>push-push</b> , <b>swap</b> , <b>swap-push</b> , and <b>swap-swap</b> .
vlan-encapsulation	Specify the encapsulation type for the VLAN operation. Supported only 802.1q.
vlan-id	Specify the outer VLAN for the VLAN operation specified.
inner-vlan-id	Specify the inner VLAN for the VLAN operation specified.

### Example for VLAN 'push' operation configuration

```

supervisor@rtbrick.net: cfg> show config set interface ifp-0/1/4 unit 1000
set interface ifp-0/1/4 unit 1000
set interface ifp-0/1/4 unit 1000 interface-type l2vpn-vpws
set interface ifp-0/1/4 unit 1000 output-vlan-map vlan-operation push
set interface ifp-0/1/4 unit 1000 output-vlan-map vlan-id 1001
set interface ifp-0/1/4 unit 1000 instance vrf2-evpn-vpws
set interface ifp-0/1/4 unit 1000 vlan 1000

```

### Example: VLAN 'push' operation configuration.

```

supervisor@rtbrick.net: cfg> show config interface ifp-0/1/4 unit 1000
{
  "rtbrick-config:unit": [
    {
      "unit-id": 1000,
      "interface-type": "l2vpn-vpws",
      "output-vlan-map": {
        "vlan-operation": "push",
        "vlan-id": 1001
      },
      "instance": "vrf2-evpn-vpws",
      "vlan": 1000
    }
  ]
}

```

## Configuring EVPN Local Cross-Connect

Local cross-connect is a special case of VPWS in which local and remote sites are

connected to the same router. When the VPWS configuration is received, BGP checks if the exact remote site is locally configured. If so, BGP understands it needs to perform a local cross-connect. Local cross-connect for the local site and remote site and vice versa should be configured on the same VRF instance.

The following example shows a single-tagged interface configuration for the VRF instance (`evpn-vpws-vrf1`).

```
set interface ifp-0/0/17 unit 0
set interface ifp-0/0/17 unit 0 interface-type l2vpn-vpws
set interface ifp-0/0/17 unit 0 instance evpn-vpws-vrf1
set interface ifp-0/0/17 unit 0 vlan 100
set interface ifp-0/0/17 unit 10
set interface ifp-0/0/17 unit 10 interface-type l2vpn-vpws
set interface ifp-0/0/17 unit 10 instance evpn-vpws-vrf1
set interface ifp-0/0/17 unit 10 vlan 100
commit
```

The following examples show the local cross-connect configurations for the same VRF instance (`evpn-vpws-vrf1`).

```
set instance evpn-vpws-vrf1 protocol bgp local-as 65006
set instance evpn-vpws-vrf1 protocol bgp address-family l2vpn evpn-vpws
set instance evpn-vpws-vrf1 protocol bgp address-family l2vpn evpn-vpws interface
ifl-0/0/17/0
set instance evpn-vpws-vrf1 protocol bgp address-family l2vpn evpn-vpws interface
ifl-0/0/17/0 local-service-id 100
set instance evpn-vpws-vrf1 protocol bgp address-family l2vpn evpn-vpws interface
ifl-0/0/17/0 remote-service-id 101
commit
```

```
set instance evpn-vpws-vrf1 protocol bgp local-as 65006
set instance evpn-vpws-vrf1 protocol bgp address-family l2vpn evpn-vpws
set instance evpn-vpws-vrf1 protocol bgp address-family l2vpn evpn-vpws interface
ifl-0/0/17/10
set instance evpn-vpws-vrf1 protocol bgp address-family l2vpn evpn-vpws interface
ifl-0/0/17/10 local-service-id 101
set instance evpn-vpws-vrf1 protocol bgp address-family l2vpn evpn-vpws interface
ifl-0/0/17/10 remote-service-id 100
commit
```

### 3.2.3. EVPN VPWS Operational Commands

#### EVPN VPWS Show Commands

The following show commands display the EVPN VPWS-related information.

## BGP Summary

This command displays BGP protocol parameters like attributes or timers that are generic to the BGP instance.

### Syntax:

**show bgp summary** <option>

Attribute	Description
Option	Description
-	Without any option, the command displays the information for all instances.

Example: BGP summary for instance **evpn-vpws-vrf1**

```

supervisor@rtbrick: op> show bgp summary instance evpn-vpws-vrf1
Instance: evpn-vpws-vrf1
  General information
    Hostname: , Domain name:
    Local AS: 65006, Version: 4
    Local preference: 100, eBGP Protocol preference: 20, iBGP Protocol preference:
200
    Router ID: 192.168.6.10, Cluster ID: 192.168.6.10
  Capabilities
    Route refresh: True, AS4: True, Graceful restart: False, L2VPN EVPN-VPWS:True
  Best route selection
    Always compare MED: False, Ignore as path: False
    Ignore local preference: False, Ignore origin: False
    Ignore MED: False, Ignore route source: False
    Ignore router ID: False, Ignore uptime: True
    Ignore cluster length: False, Ignore peer IP: False
    Route select parameter: 0
  Timers
    Connect retry: 30s, Keepalive: 30s, Holdtime: 90s
  Statistics
    Peers configured: 0, Peers auto discovery: 0
    Peers in idle           : 0
    Peers in connect       : 0
    Peers in active        : 0
    Peers in opensent      : 0
    Peers in openconfirm   : 0
    Peers in established   : 0

```

## BGP Peer

The 'show bgp peer' commands display information on BGP peers.

### Syntax:

**show bgp peer** <option>

Option	Description
-	Without any option, the commands display all BGP peers in all instances in a summary table format.
detail	Detailed information on all BGP peers in all instances in a list view.
<peer-name>	Detailed information on the peer with the given name.
address <peer-address>	Detailed information on the peer with the given IP address.
history	Displays BGP peer history information such as the peer state down reasons.
history <peer-address>	Displays BGP peer history information such as the peer state down reasons for a specified peer.
instance <instance-name>	Summary of all BGP peers in the given instance.
instance <instance-name> detail	Detailed information on all BGP peers in the given instance.
instance <instance-name> detail <peer-name>	Detailed information on the peer with the given name in the given instance.
instance <instance-name> detail address <peer-address>	Detailed information on the peer with the given IP address in the given instance.
statistics	Received and sent BGP prefixes per AFI/SAFI for all peers in all instances.
statistics peer <peer-name>	Received and sent BGP prefixes per AFI/SAFI for the peer with the given name.
statistics peer address <peer-address>	Received and sent BGP prefixes per AFI/SAFI for the peer with the given IP address.
statistics instance <instance-name> peer <peer-name>	Received and sent BGP prefixes per AFI/SAFI for the peer with the given name in the given instance.
statistics instance <instance-name> peer address <peer-address>	Received and sent BGP prefixes per AFI/SAFI for the peer with the given IP address in the given instance.

### Example 1: BGP Peer Information for instance **default**

```

supervisor@rtbrick: op> show bgp peer instance default
Instance: default
  Peer      Remote AS    State           Up/Down Time   PfxRcvd      PfxSent
  spine1    4200000000   Established      0d:00h:42m:53s  5             14
supervisor@rtbrick: op>

```

### Example 2: Detailed view of BGP Peer Information

```

supervisor@rtbrick: op> show bgp peer detail
Peer: spine1, Peer IP: fe80::9a19:2cff:fe99:4701, Remote AS: 4200000000, Local:
fe80::9a19:2cff:fe36:3e03, Local AS: 4200000004, Any AS: False
Type: ebgp, State: Established, Up/Down Time: 0d:01h:00m:40s
Discovered on interface: ifl-0/0/2/1
Last transition: Thu Apr 18 04:50:56 GMT +0000 2024, Flap count: 0
Peer ID      : 192.1.0.1, Local ID   : 192.1.0.4
Instance     : default, Peer group: spine
6PE enabled  : False
Timer values:
  Peer keepalive : 30s, Local keepalive: 30s
  Peer holddown  : 90s, Local holddown : 90s
  Connect retry  : 30s
Timers:
  Connect retry timer : 0s
  Keepalive timer     : expires in 21s 796304us
  Holddown timer      : expires in 1m 13s 560627us
NLRIs:
  Sent              : ['l2vpn-evpn', 'ipv4-unicast', 'ipv6-unicast', 'ipv4-vpn-
unicast', 'ipv6-vpn-unicast', 'ipv4-vpn-multicast', 'l2vpn-vpls', 'ipv4-labeled-
unicast', 'ipv6-labeled-unicast']
  Received          : ['l2vpn-evpn', 'ipv4-unicast', 'ipv6-unicast', 'ipv4-vpn-
unicast', 'ipv6-vpn-unicast', 'ipv4-vpn-multicast', 'l2vpn-vpls', 'ipv4-labeled-
unicast', 'ipv6-labeled-unicast']
  Negotiated        : ['l2vpn-evpn', 'ipv4-unicast', 'ipv6-unicast', 'ipv4-vpn-
unicast', 'ipv6-vpn-unicast', 'ipv4-vpn-multicast', 'l2vpn-vpls', 'ipv4-labeled-
unicast', 'ipv6-labeled-unicast']
Capabilities:
  Addpath sent      : None
  Addpath received  : None
  Addpath negotiated : None
  Extended nexthop sent : ['ipv4-unicast', 'ipv4-vpn-unicast', 'ipv4-
vpn-multicast', 'ipv4-labeled-unicast']
  Extended nexthop received : ['ipv4-unicast', 'ipv4-labeled-unicast',
'ipv4-vpn-multicast', 'ipv4-vpn-unicast']
  Extended nexthop negotiated : ['ipv4-unicast', 'ipv4-labeled-unicast',
'ipv4-vpn-multicast', 'ipv4-vpn-unicast']
Capabilities:
  Feature           Sent      Received      Negotiated
  Route refresh     True      True          True
  4 byte AS         True      True          True
  Graceful restart  False     False         False
  Link local only   False     False         False
Prefix Limit:
End of RIB:
  Address family    Sent      Received
  IPv4 unicast      Thu Apr 18 04:50:59 GMT +0000 2024  Thu Apr 18

```

```

04:50:59 GMT +0000 2024
  IPv4 labeled-unicast          Thu Apr 18 04:50:59 GMT +0000 2024  Thu Apr 18
04:50:59 GMT +0000 2024
  IPv6 unicast                  Thu Apr 18 04:50:59 GMT +0000 2024  Thu Apr 18
04:50:59 GMT +0000 2024
  IPv6 labeled-unicast          Thu Apr 18 04:50:59 GMT +0000 2024  Thu Apr 18
04:50:59 GMT +0000 2024
  IPv4 VPN-unicast              Thu Apr 18 04:50:59 GMT +0000 2024  Thu Apr 18
04:50:59 GMT +0000 2024
  IPv6 VPN-unicast              Thu Apr 18 04:50:59 GMT +0000 2024  Thu Apr 18
04:50:59 GMT +0000 2024
  IPv4 VPN-multicast            Thu Apr 18 04:50:59 GMT +0000 2024  Thu Apr 18
04:50:59 GMT +0000 2024
  L2VPN VPLS                    Thu Apr 18 04:50:59 GMT +0000 2024  Thu Apr 18
04:50:59 GMT +0000 2024
  L2VPN EVPN                     Thu Apr 18 04:50:59 GMT +0000 2024  Thu Apr 18
04:50:59 GMT +0000 2024
  Message stats:
    Session stats:
      Direction  Open          Update          Keepalive        Notify          Route
refresh
  Input         0             0                72              0              0
  Output        0             0                71              0              0
  Total stats:
  Input         0             0                72              0              0
  Output        0             0                71              0              0
  Route stats:
  Address family          Received      Sent          Prefix limit Idle
timeout
  IPv4 unicast            0             0             0             0
  IPv4 labeled-unicast    0             0             0             0
  IPv6 unicast            0             0             0             0
  IPv6 labeled-unicast    0             0             0             0
  IPv4 VPN-unicast        0             0             0             0
  IPv6 VPN-unicast        0             0             0             0
  IPv4 VPN-multicast      0             0             0             0
  L2VPN VPLS              0             0             0             0
  L2VPN EVPN              0             0             0             0
<...>

```

### Example 3: BGP Peer Statistics for a specific peer

```

supervisor@rtbrick: op> show bgp peer statistics peer address
fe80::781a:c6ff:fec0:1
Instance: default
Peer          AFI    SAFI          PfxRcvd    PfxSent
spinel        ipv4    unicast       0           0
              ipv4    labeled-unicast 0           0
              ipv6    unicast       1           4
              ipv6    labeled-unicast 1           4
              ipv4    vpn-unicast    0           0
              ipv6    vpn-unicast    0           0
              ipv4    multicast     0           0
              ipv4    vpn-multicast  0           0
              l2vpn   evpn          3           6

```

### Example 4: BGP Peer history for a specified peer

```

supervisor@rtbrick.net: op> show bgp peer history peer address 192:168::40
Instance: ip2vrf
  Peer Address          Source Address          Type          Last
Reset Reason
  192:168::40          192:168:5::20          FSM Error     FSM
Error, Sub-Code: Unexpected message in OpenSent State

```

## BGP RIB-in

This command displays the received routes.

### Syntax:

**show bgp rib-in** <option>

Option	Description
-	Without any option, the command displays information on the received BGP routing table on all instances in a summary table format.
<afi>	BGP routing table summary for the given address family (AFI), all sub-address families and all instances. Supported AFI values are 'ipv4', 'ipv6' and <b>l2vpn</b> .
<afi> <safi>	BGP routing table summary for the given address family (AFI) and sub-address family (SAFI), and all instances. Supported SAFI values are <b>evpn</b> , 'labeled-unicast', 'unicast', 'vpn-multicast', 'vpn-unicast', and <b>evpn-vpws</b> .
<afi> <safi> detail	Detailed list view of the BGP routing table for the given address family (AFI) and sub-address family (SAFI), and all instances.
<afi> <safi> <prefix>	BGP routing table entry for the given prefix and all instances.
<afi> <safi> instance <instance-name>	BGP routing table summary for the given AFI, SAFI, and instance.
<afi> <safi> instance <instance-name> detail	Detailed list view of BGP routing table for the given AFI, SAFI, and instance.
<afi> <safi> instance <instance-name> <prefix>	BGP routing table entry for the given prefix and instance.

Option	Description
<afi> <safi> community <community-name>	BGP community details for the given AFI, SAFI, and instance.
<afi> <safi> error	BGP route with error status for the given AFI, SAFI, and instance.
<afi> <safi> peer <name> / peer address <ip>	Peer name or address

Example 1: Summary view of the BGP rib-in where you can find received information for the EVPN VPWS instances like evpn-vpws-vrf1, evpn-vpws-vrf2, and evpn-vpws-vrf3.

```

supervisor@rtbrick: op> show bgp rib-in
Flags: & - Imported, ! - Error
Instance: default, AFI: ipv6, SAFI: unicast
  Hostname: Local, Peer IP: 0.0.0.0
  Source IP: 0.0.0.0, Total routes: 3
  Prefix
AS Path      Status      Next Hop      MED      Lpref
192:1::3/128
- Valid
192:1::5/128
- Valid
192:1::6/128
- Valid
  Hostname: spine1, Peer IP: fe80::781a:c6ff:fec0:1
  Source IP: fe80::7857:d6ff:fec0:0, Total routes: 1
  Prefix
AS Path      Status      Next Hop      MED      Lpref
192:1::1/128
4200000000 Valid      fe80::781a:c6ff:fec0:1      0      -
Instance: default, AFI: ipv6, SAFI: labeled-unicast
  Hostname: Local, Peer IP: 0.0.0.0
  Source IP: 0.0.0.0, Total routes: 3
  Prefix
AS Path      Status      Next Hop      MED      Lpref
192:1::3/128
- Valid
192:1::5/128
- Valid
192:1::6/128
- Valid
  Hostname: spine1, Peer IP: fe80::781a:c6ff:fec0:1
  Source IP: fe80::7857:d6ff:fec0:0, Total routes: 1
  Prefix
AS Path      Status      Next Hop      MED      Lpref
192:1::1/128
4200000000 Valid      fe80::781a:c6ff:fec0:1      0      -
Instance: evpn-vpws-vrf1, AFI: l2vpn, SAFI: evpn-vpws
  Hostname: Local, Peer IP: 0.0.0.0
  Source IP: 0.0.0.0, Total routes: 1
  Prefix
AS Path      Status      Next Hop      MED      Lpref
00.00.00.00.00.00.00.00.00.00:100/112
- Valid
Instance: evpn-vpws-vrf2, AFI: l2vpn, SAFI: evpn-vpws
  Hostname: Local, Peer IP: 0.0.0.0
  Source IP: 0.0.0.0, Total routes: 1
  Prefix
AS Path      Status      Next Hop      MED      Lpref
00.00.00.00.00.00.00.00.00.00:110/112
- Valid
Instance: evpn-vpws-vrf3, AFI: l2vpn, SAFI: evpn-vpws

```



```

Hostname: Local, Peer IP: 0.0.0.0
Source IP: 0.0.0.0, Total routes: 1
  Prefix                               Next Hop                               MED     Lpref
AS Path  Status
  00.00.00.00.00.00.00.00.00.00:200/112  -                               0       100
-      Valid
Instance: default, AFI: l2vpn, SAFI: evpn
Hostname: spine1, Peer IP: fe80::781a:c6ff:fec0:1
Source IP: fe80::7857:d6ff:fec0:0, Total routes: 3
  Prefix                               Next Hop                               MED     Lpref
AS Path  Status
  00.00.00.00.00.00.00.00.00.00:101/112  192:1::1                          0       -
4200000000 Valid
  00.00.00.00.00.00.00.00.00.00:111/112  192:1::1                          0       -
4200000000 Valid
  00.00.00.00.00.00.00.00.00.00:201/112  192:1::1                          0       -
4200000000 Valid
    
```

Example 2: Summary view of the BGP rib-in where you can find received information for address family **l2vpn vpw**s.

```

supervisor@rtbrick: op> show bgp rib-in l2vpn evpn
Flags: & - Imported, ! - Error
Instance: default, AFI: l2vpn, SAFI: evpn
Hostname: spine1, Peer IP: fe80::9a19:2cff:fe99:4701, Source IP: fe80::9a19:2cff:fe36:3e03, Total routes: 3
  Prefix                               Next Hop                               MED     Lpref
AS Path  Status
  00.00.00.00.00.00.00.00.00.00:101/112  192:1::1                          0       -
4200000000, 4200000003 Valid
  00.00.00.00.00.00.00.00.00.00:111/112  192:1::1                          0       -
4200000000, 4200000003 Valid
  00.00.00.00.00.00.00.00.00.00:201/112  192:1::1                          0       -
4200000000, 4200000003 Valid
    
```

Example 3: Summary view of the BGP RIB in with the error flag.

```

supervisor@rtbrick.net: cfg> show bgp rib-in l2vpn vpls
Flags: & - Imported, ! - Error
Instance: default, AFI: l2vpn, SAFI: vpls
Hostname: RR1, Peer IP: 192.168.0.30
Source IP: 192.168.0.40, Total routes: 2
  Flags  Prefix                               Next Hop                               MED  Lpref  AS
Path
  00.00.00.00.00.00.00.00.00.00:100/112  192.168.3.21  -    100
4200000001
  00.00.00.00.00.00.00.00.00.00:210/112  192.168.3.21  -    100
4200000001
    
```

## BGP FIB

The 'show bgp fib' commands display the BGP forwarding table.

### Syntax:

**show bgp fib** <option>

Option	Description
-	Without any option, the commands display the BGP forwarding table for all address families and all instances in a summary table format.
<afi>	BGP forwarding table summary for the given address family (AFI), all sub-address families and all instances. Supported AFI values are <b>l2vpn</b> , 'ipv4' and 'ipv6'.
<afi> <safi>	BGP forwarding table summary for the given address family (AFI) and sub-address family (SAFI), and all instances. Supported SAFI values are 'unicast', 'labeled-unicast', 'vpn-multicast', 'vpn-unicast', and <b>evpn-vpws</b> .
<afi> <safi> detail	Detailed list view of the BGP forwarding table for the given address family (AFI) and sub-address family (SAFI), and all instances.
<afi> <safi> <prefix>	BGP forwarding table entry for the given prefix and all instances.
<afi> <safi> instance <instance-name>	BGP forwarding table summary for the given AFI, SAFI, and instance.
<afi> <safi> instance <instance-name> detail	Detailed list view of BGP forwarding table for the given AFI, SAFI, and instance.
<afi> <safi> instance <instance-name> <prefix>	BGP forwarding table entry for the given prefix and instance.

```

supervisor@rtbrick: op> show bgp fib
Instance: default, AFI: ipv6, SAFI: unicast
  Prefix                Preference    Out Label    Next Hop
  192:1::1/128          20           -            fe80::781a:c6ff:fec0:1
Instance: default, AFI: ipv6, SAFI: labeled-unicast
  Prefix                Preference    Out Label    Next Hop
  192:1::1/128          20           -            fe80::781a:c6ff:fec0:1
Instance: evpn-vpws-vrf1, AFI: l2vpn, SAFI: evpn-vpws
  Prefix                Preference    Out Label    Next Hop
  00.00.00.00.00.00.00.00.00:101/112  20           20004,bos:1  192:1::1
Instance: evpn-vpws-vrf2, AFI: l2vpn, SAFI: evpn-vpws
  Prefix                Preference    Out Label    Next Hop
  00.00.00.00.00.00.00.00.00:111/112  20           20005,bos:1  192:1::1
Instance: evpn-vpws-vrf3, AFI: l2vpn, SAFI: evpn-vpws
  Prefix                Preference    Out Label    Next Hop
  00.00.00.00.00.00.00.00.00:201/112  20           20006,bos:1  192:1::1
    
```

## BGP RIB-out

This command displays the routes that were advertised to peers.

### Syntax:

**show bgp rib-out** <option>

Option	Description
-	Without any option, the command displays advertised BGP routes for all instances.
<afi>	BGP routing table summary for the given address family (AFI), all sub-address families and all instances. Supported AFI values are <b>l2vpn</b> , 'ipv4' and 'ipv6'.
<afi> <safi>	BGP routing table summary for the given address family (AFI) and sub-address family (SAFI), and all instances. Supported SAFI values are <b>evpn</b> , 'unicast', 'labeled-unicast', 'multicast', and 'vpn-unicast'.
<afi> <safi> detail	Detailed list view of the BGP routing table for the given address family (AFI) and sub-address family (SAFI), and all instances.
<afi> <safi> <prefix>	BGP routing table entry for the given prefix and all instances.
<afi> <safi> instance <instance-name>	BGP routing table summary for the given AFI, SAFI, and instance.
<afi> <safi> instance <instance-name> detail	Detailed list view of BGP routing table for the given AFI, SAFI, and instance.
<afi> <safi> instance <instance-name> <prefix>	BGP routing table entry for the given prefix and instance.
<afi> <safi> peer <name> / peer address <ip>	Peer name or address

Example 1: Summary view of the routes advertised to a peer

```

supervisor@rtbrick: op> show bgp rib-out
Instance: default, AFI: ipv6, SAFI: unicast
Peer-group: spine, Sent routes: 4
Prefix                                MED          Lpref        Origin       Next Hop
AS Path
192:1::1/128                          0            -            Incomplete  -
    
```

```

4200000003, 4200000000
  192:1::3/128          0          -          Incomplete  -
4200000003
  192:1::5/128          0          -          Incomplete  -
4200000003
  192:1::6/128          0          -          Incomplete  -
4200000003
Instance: default, AFI: ipv6, SAFI: labeled-unicast
Peer-group: spine, Sent routes: 4
  Prefix                MED          Lpref        Origin       Next Hop
AS Path
  192:1::1/128          0          -          Incomplete  -
4200000003, 4200000000
  192:1::3/128          0          -          Incomplete  -
4200000003
  192:1::5/128          0          -          Incomplete  -
4200000003
  192:1::6/128          0          -          Incomplete  -
4200000003
Instance: default, AFI: l2vpn, SAFI: evpn
Peer-group: spine, Sent routes: 6
  Prefix                MED          Lpref        Origin       Next Hop
AS Path
  00.00.00.00.00.00.00.00.00:100/112  0          -          Incomplete  192:1::3
4200000003
  00.00.00.00.00.00.00.00.00:101/112  0          -          Incomplete  192:1::3
4200000003, 4200000000
  00.00.00.00.00.00.00.00.00:110/112  0          -          Incomplete  192:1::3
4200000003
  00.00.00.00.00.00.00.00.00:111/112  0          -          Incomplete  192:1::3
4200000003, 4200000000
  00.00.00.00.00.00.00.00.00:200/112  0          -          Incomplete  192:1::3
4200000003
  00.00.00.00.00.00.00.00.00:201/112  0          -          Incomplete  192:1::3
4200000003, 4200000000

```

## BGP L2VPN

This command displays the BGP L2VPN information.

### Syntax:

**show bgp l2vpn** <option>

Option	Description
pseudowire	Displays pseudowire information for all instances.
pseudowire instance <name>	Displays pseudowire information for the specified instance.

Example: Display L2VPN pseudowire information for instance **evpn-vpws-vrf1**

```

supervisor@rtbrick: op> show bgp l2vpn pseudowire instance evpn-vpws-vrf1
Instance: evpn-vpws-vrf1 AFI: l2vpn, SAFI: evpn-vpws
Peer IP: 12.0.0.2
Route Distinguisher: 192.168.6.10:65006
Number of local interfaces: 1
Interface name Prefix                Status          Local SID      Remote SID     Pop
Label          Push Label
if1-0/0/3/0   00.00.00.00.00.00.00.00.00:100/112  up              100            101

```

label:20004,bos:1 label:20004,bos:1

## 3.3. BGP-signaled L2VPN

### 3.3.1. BGP-signaled L2VPN Overview

The BGP-signaled L2VPN uses BGP for signaling and auto-discovery to establish multipoint Layer 2 VPN over the MPLS backbone network. The remote cross-connect is a point-to-point (P2P) service that connects two locations using the MPLS core network and MP-BGP. The remote cross-connect uses MPLS tunnels to traverse the backbone network. It offers a Layer 2 packet forwarding mode that connects access circuits (ACs). The RBFS implementation of BGP-signaled L2VPN is in accordance with RFC-6624 which supports L2VPN using BGP for auto-discovery and Signaling.

#### Supported Standards

RFC Number	Description
6624	Layer 2 Virtual Private Networks Using BGP for Auto-Discovery and Signaling

#### BGP-signaled L2VPN Network Model

As shown in the figure below, a BGP-signaled L2VPN network contains the following building blocks:

- Customer edge (CE)—Customer device directly connected to the service provider network.
- Provider edge (PE)—Service provider device connected to CEs. PEs provide access to the Pseudowire network and forward traffic between customer network sites by using public tunnels.
- Attachment circuit (AC)—A physical or virtual link between a CE and a PE.
- Pseudowire (PW)—A virtual bidirectional connection between two PEs. A PW comprises a pair of virtual links in opposite directions.
- MPLS transport tunnel—A connection that carries one or more PWs across the MPLS core or IP backbone, such as an MPLS tunnel.
- Cross-connect—A connection formed by two physical or virtual circuits, such as

ACs and PWs, that switches packets between them.

The figure below shows the protocol packet exchange process in the BGP-signaled L2VPN.

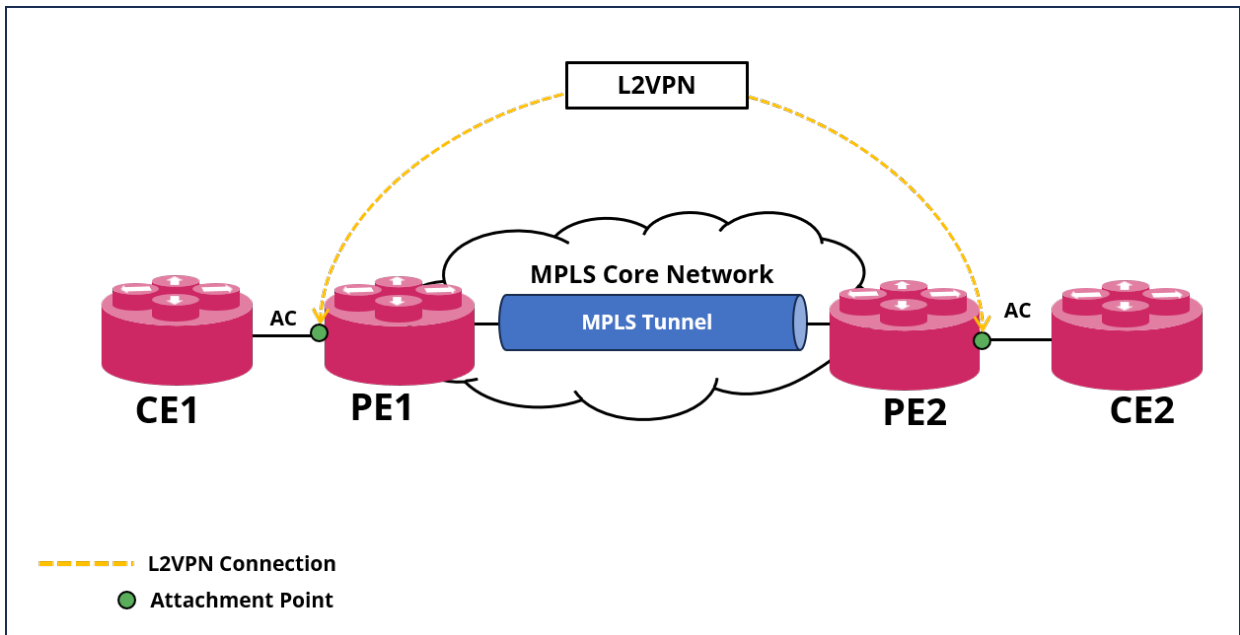

PE1 and PE2 are each configured with a BGP L2VPN instance. After the PE receives packets from the AC, it adds the PW label and sends them to the peer PE through the MPLS transport tunnel. After the other PE receives the packet via the MPLS transport path, it removes the PW label of the packets and forwards the packets to the AC bound to the PW.

## VLAN Tag Manipulation

VLAN Tag Manipulation involve modifying VLAN tags on Ethernet frames to ensure proper traffic segmentation and delivery across a Layer 2 network. RBFS supports some VLAN Tag Manipulation operations which are used to manipulate tags on Ethernet frames as they enter or leave a network interface. These manipulations include adding, removing, and rewriting VLAN tags. VLAN manipulation operations can be performed both at ingress and egress nodes.

The following VLAN manipulation operations are supported for Layer 2 VPN interfaces:

- **push:** Adds a single outer VLAN tag to an Ethernet frame.
- **pop:** Removes a single outer VLAN tag from an Ethernet tag frame.

- **swap**: Rewrite a single outer VLAN tag of an Ethernet tag frame.
- **push-push**: Adds two VLAN tags to an Ethernet frame.
- **pop-pop**: Removes two VLAN tags from an Ethernet tags frame.
- **swap-swap**: Rewrite both the outer and inner VLAN tags of an Ethernet tags frame.
- **swap-push**: Rewrite the outer VLAN tag and add a new inner VLAN tag for Ethernet tags' frame.
- **pop-swap**: Removes the outer VLAN tag and rewrites the inner VLAN tag of an Ethernet tags' frame.

### Supported CLI Options for VLAN Tag Manipulation Operations

The following table presents the various VLAN tag manipulation operations and supported CLI options.

CLI Options	pop	push	swap	push-push	pop-pop	swap-push	swap-swap	pop-swap
vlan-id	No	Yes	Yes	Yes	No	Yes	Yes	Yes
vlan-encapsulation	No	Yes	Yes	Yes	No	Yes	Yes	Yes
innervlan-id	No	No	No	Yes	No	Yes	Yes	No

### Supported Platforms

Not all features are necessarily supported on each hardware platform. Refer to the *Platform Guide* for the features and the sub-features that are or are not supported by each platform.

### Unsupported Features

The following features are not supported for the BGP-signaled L2VPN:

- Policy filtering options (at Address Family/Peer-Group/Instance levels)
- LAG interface as an attachment circuit
- LAG interface as an LSP MPLS path
- Route Reflection
- Add-Path

- VLAN change configuration on L2 IFL

## Guidelines and Limitations

- The **control-word** flag is disabled by default in Layer 2 Attributes Extended Community. To ensure interoperability with RBFS, the **control-word** flag needs to be disabled.

### 3.3.2. Configuring BGP-signaled L2VPN

#### Configuration Hierarchy

The diagram illustrates the BGP-signaled L2VPN configuration hierarchy. All BGP-signaled L2VPN configurations are done within an instance, such as the default instance or an EVPN service instance.

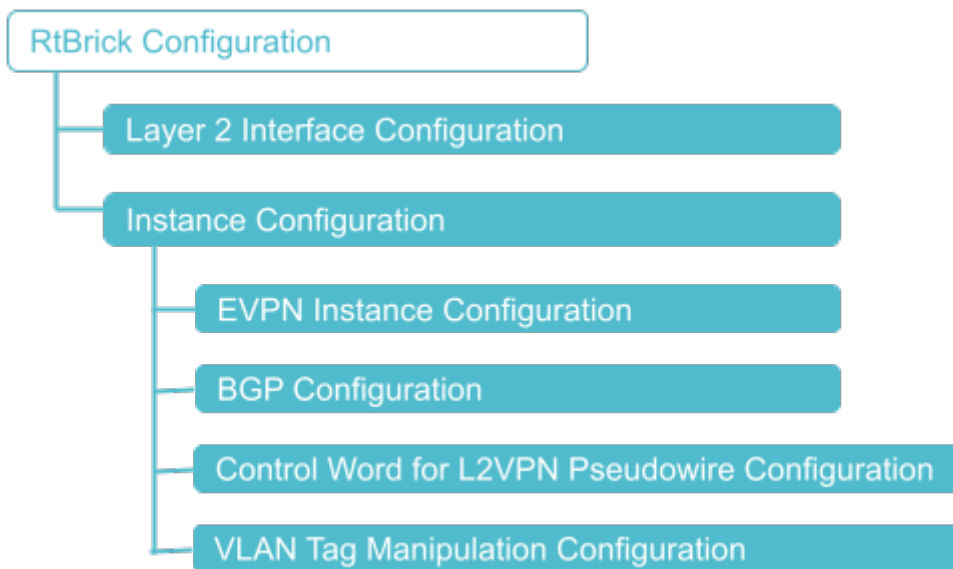

#### Configuration Syntax and Commands

The following sections describe the BGP-signaled L2VPN configuration syntax and commands.

##### Layer 2 Interface Configuration

BGP-signaled L2VPN supports the configuration of Layer 2 logical interfaces.

##### Syntax:



**set interface** <name> <attribute> <value>

Attribute	Description
<name>	Specify the name of the interface. Example: ifp-0/0/1.
unit <unit-id>	Create a logical interface (also referred to as a sub-interface) under the physical interface
unit <unit-id> interface-type l2vpn-vpws	Specify the type of the L2VPN interface.
unit <unit-id> match-type port	Sets the "port" match-type for the L2VPN VPWS untagged interfaces. For tagged interfaces, "port" match-type is not supported. Ensure that there are no other tagged configurations for the interfaces when the port match-type is configured. When port matching is configured, it will match all traffic regardless of whether it is untagged, single-tagged, or double-tagged VLANs.
unit <unit-id> vlan <outer-vlan-id>	Outer VLAN ID.
unit <unit-id> vlan <inner-vlan-id>	Inner VLAN ID.
unit <unit-id> instance <instance>	Assign the logical interface to an instance.

The following example shows an untagged interface configuration along with "port" match-type for the L2VPN VPWS untagged interface.

```
set interface ifp-0/0/17 unit 0
set interface ifp-0/0/17 unit 0 interface-type l2vpn-vpws
set interface ifp-0/0/17 unit 0 match-type port
set interface ifp-0/0/17 unit 0 instance evpn-vpws-vrf1
commit
```

The following example shows a single-tagged interface configuration:

```
set interface ifp-0/0/17 unit 100
set interface ifp-0/0/17 unit 100 interface-type l2vpn-vpws
set interface ifp-0/0/17 unit 100 instance l2vpn_cel
set interface ifp-0/0/17 unit 100 vlan 100
commit
```

The following example shows a double-tagged interface configuration:

```

set interface ifp-0/0/17 unit 200
set interface ifp-0/0/17 unit 200 interface-type l2vpn-vpws
set interface ifp-0/0/17 unit 200 instance l2vpn_ce2
set interface ifp-0/0/17 unit 200 vlan 200
set interface ifp-0/0/17 unit 200 inner-vlan 201
commit
    
```

### EVPN Instance Configuration

An EVPN Instance (EVI) is a routing and forwarding instance of EVPN that covers all the participating PE routers in a VPN. EVI is configured per customer on the PE routers. Each EVI has a unique route distinguisher and one or more route targets.

#### Syntax:

**set instance** <name> <attribute> <value>

Attribute	Description
<name>	A unique name for the EVPN routing instance.
address-family <afi>	Address family identifier (AFI). Supported value: l2vpn
address-family <afi> <safi>	Subsequent address family identifier (SAFI). Supported values: vpls-vpws
	 The SAFI <b>vpls-vpws</b> needs to be enabled on the VRF instance.
protocol	Specifies the routing protocol
route-distinguisher <as-number   ipv4-address:id>	The route distinguisher (RD) uniquely defines routes within an IPv4 network. PE routers use route distinguishers to identify which VPN a packet belongs to. Supported formats are <as-number:id> or <ipv4-address:id>.
ipv4-router-id <ipv4-router-id>	The router ID of the routing instance.

Attribute	Description
route-target ( import   export ) <rt-value>	Route targets (RT) are used to transfer routes between VPN instances. The RT identifies a subset of routes that should be imported to or exported from a particular VPN instance. You can configure an RT for importing or exporting routes or both.

In the following configuration, VRF instance AFI has been set to AFI: **l2vpn** and SAFI: **vpls-vpws**.

```
set instance l2vpn_cel
set instance l2vpn_cel ipv4-router-id 182.1.6.4
set instance l2vpn_cel route-distinguisher 182.1.6.4:65006
set instance l2vpn_cel address-family l2vpn vpls-vpws
set instance l2vpn_cel address-family l2vpn vpls-vpws route-target import
target:182.1.6.0:65006
set instance l2vpn_cel address-family l2vpn vpls-vpws route-target export
target:182.1.6.0:65006
commit
```

## BGP Configuration

### BGP L2VPN VFT (Virtual Forwarding Table) Configuration

#### Syntax:

**set instance** <name> **protocol bgp** <attribute> <value>

Attribute	Description
<name>	Name of the routing instance
address-family <afi>	Address family identifier (AFI). Supported value: l2vpn
address-family <afi> <safi>	Subsequent address family identifier (SAFI). Supported value: vpls-vpws
	 The SAFI <b>vpls-vpws</b> needs to be enabled on the VFT instance.
local-as <as-number>	The AS number in four-byte format. The numbers allowed are from 1 to 4294967285.
interface <name>	Interface that is bound to L2VPN

Attribute	Description
interface <name> local-site-id <local-site-id>	Specify the local site ID that is used to establish an EVPN PW between two PEs
interface <name> remote-site-id <remote-site-id>	Specify the remote site ID that is used to establish an EVPN PW between two PEs
interface <name> label-base <value>	Specify the label base value.

The following example configures `l2vpn_ce1` instance for BGP L2VPN.

```

set instance l2vpn_ce1 protocol bgp local-as 65006
set instance l2vpn_ce1 protocol bgp address-family l2vpn vpls-vpws
set instance l2vpn_ce1 protocol bgp address-family l2vpn vpls-vpws interface ifl-0/0/17/100
set instance l2vpn_ce1 protocol bgp address-family l2vpn vpls-vpws interface ifl-0/0/17/100 local-site-id 300
set instance l2vpn_ce1 protocol bgp address-family l2vpn vpls-vpws interface ifl-0/0/17/100 remote-site-id 301
set instance l2vpn_ce1 protocol bgp address-family l2vpn vpls-vpws interface ifl-0/0/17/100 label-base 150000
commit
    
```

## BGP L2VPN Configuration

### Configuring the BGP L2VPN Address Family

#### Syntax:

**set instance <name> protocol bgp address-family l2vpn vpls**

Attribute	Description
<name>	Name of the routing instance

To configure BGP L2VPN VPLS on the default instance, enter the following command:

```

set instance default protocol bgp address-family l2vpn vpls
commit
    
```

### Configuring Address Families for Peer Groups

#### Syntax:

**set instance** <instance-name> **protocol bgp peer-group** <pg-name> **address-family** <afi> <safi> <attribute> <value>

Attribute	Description
<afi>	Address family identifier (AFI). Supported value: l2vpn.
<safi>	Subsequent address family identifier (SAFI). Supported value: vpls
extended-nexthop	Enable extended-next-hop encoding for BGP peer groups to allow the transfer of IPv4 prefixes over an IPv6 connection.
update-nexthop ( ipv4-address   ipv6-address ) <address>	BGP nexthop address for routes advertised to this peer group

To configure BGP L2VPN Peer Group on the **default** instance, enter the following command:

```
set instance default protocol bgp peer-group spine address-family l2vpn vpls
commit
```

## Configuring Control Word for L2VPN Pseudowire

A control word can be inserted between the label stack and the MPLS payload. Control word is disabled by default.

### Syntax:

**set instance** <name> **protocol bgp address-family l2vpn vpls-vpws interface** <interface> **control-word enable**

Attribute	Description
<name>	Name of the routing instance.
<interface>	Name of the interface.

Example: Enter the following command to enable Control Word on the **default** instance.

```
set instance default protocol bgp peer-group spine address-family l2vpn vpls-vpws
interface if1-0/0/1/10 control-word enable
```

commit

## Configuring VLAN Tag Manipulation

The following section describes the VLAN tag manipulation configuration syntax and commands.

### Syntax:

**set interface** <interface-name> **unit** <unit id> [**input-vlan-map** | **output-vlan-map**] <attribute> <value>

Attribute	Description
<name>	Specify the name of the interface.
unit <unit-id>	Specify the unit ID for the interface.
unit <unit-id> input-vlan-map	Ingress VLAN mapping.
unit <unit-id> output-vlan-map	Egress VLAN mapping
vlan-operation	Specify any of the VLAN operations supported: <b>pop</b> , <b>pop-pop</b> , <b>pop-swap</b> , <b>push</b> , <b>push-push</b> , <b>swap</b> , <b>swap-push</b> , and <b>swap-swap</b> .
vlan-encapsulation	Specify the encapsulation type for the VLAN operation. Supported only 802.1q.
vlan-id	Specify the outer VLAN for the VLAN operation specified.
inner-vlan-id	Specify the inner VLAN for the VLAN operation specified.

### Example for VLAN operation 'push' configuration

```

supervisor@rtbrick.net: cfg> show config set interface ifp-0/1/4 unit 1000
set interface ifp-0/1/4 unit 1000
set interface ifp-0/1/4 unit 1000 interface-type l2vpn-vpws
set interface ifp-0/1/4 unit 1000 input-vlan-map vlan-operation push
set interface ifp-0/1/4 unit 1000 input-vlan-map vlan-id 1001
set interface ifp-0/1/4 unit 1000 instance l2vpn_cel
set interface ifp-0/1/4 unit 1000 vlan 1000
    
```

## Example: VLAN operation 'push' configuration output

```

supervisor@rtbrick.net: cfg> show config interface ifp-0/1/4 unit 1000
{
  "rtbrick-config:unit": [
    {
      "unit-id": 1000,
      "interface-type": "l2vpn-vpws",
      "input-vlan-map": {
        "vlan-operation": "push",
        "vlan-id": 1001
      },
      "instance": "l2vpn_ce1",
      "vlan": 1000
    }
  ]
}

```

## Example for VLAN operation 'push-push' configuration

```

supervisor@rtbrick.net: cfg> show config set interface ifp-0/1/5 unit 2000
set interface ifp-0/1/5 unit 2000
set interface ifp-0/1/5 unit 2000 interface-type l2vpn-vpws
set interface ifp-0/1/5 unit 2000 input-vlan-map vlan-operation push-push
set interface ifp-0/1/5 unit 2000 input-vlan-map vlan-id 2000
set interface ifp-0/1/5 unit 2000 input-vlan-map inner-vlan-id 2001
set interface ifp-0/1/5 unit 2000 instance l2vpn_ce1
set interface ifp-0/1/5 unit 2000 vlan 2000
set interface ifp-0/1/5 unit 2000 inner-vlan 2

```

## Example: VLAN operation 'push-push' configuration

```

supervisor@rtbrick.net: cfg> show config interface ifp-0/1/5 unit 2000
{
  "rtbrick-config:unit": [
    {
      "unit-id": 2000,
      "interface-type": "l2vpn-vpws",
      "input-vlan-map": {
        "vlan-operation": "push-push",
        "vlan-id": 2000,
        "inner-vlan-id": 2001
      },
      "instance": "l2vpn_ce1",
      "vlan": 2000,
      "inner-vlan": 2
    }
  ]
}

```

### 3.3.3. BGP L2VPN Operational Commands

#### BGP L2VPN Show Commands

The following show commands display the BGP L2VPN-related information.

#### BGP Summary

This command displays BGP protocol parameters like attributes or timers that are generic to the BGP instance.

#### Syntax:

**show bgp summary** <option>

Attribute	Description
Option	Description
-	Without any option, the command displays the information for all instances.

Example: BGP summary for instance **l2vpn\_ce1**

```

supervisor@rtbrick: op> show bgp summary instance l2vpn_ce1
Instance: l2vpn_ce1
  General information
    Hostname: , Domain name:
    Local AS: 65006, Version: 4
    Local preference: 100, eBGP Protocol preference: 20, iBGP Protocol preference:
200
    Router ID: 182.1.6.4, Cluster ID: 182.1.6.4
  Capabilities
    Route refresh: True, AS4: True, Graceful restart: False, L2VPN VPLS-VPWS:True
  Best route selection
    Always compare MED: False, Ignore as path: False
    Ignore local preference: False, Ignore origin: False
    Ignore MED: False, Ignore route source: False
    Ignore router ID: False, Ignore uptime: True
    Ignore cluster length: False, Ignore peer IP: False
    Route select parameter: 0
  Timers
    Connect retry: 30s, Keepalive: 30s, Holdtime: 90s
  Statistics
    Peers configured: 0, Peers auto discovery: 0
    Peers in idle           : 0
    Peers in connect       : 0
    Peers in active        : 0
    Peers in opensent      : 0
    Peers in openconfirm   : 0
    
```



## BGP Peer

The 'show bgp peer' commands display information on BGP peers.

### Syntax:

**show bgp peer** <option>

Option	Description
-	Without any option, the commands display all BGP peers in all instances in a summary table format.
detail	Detailed information on all BGP peers in all instances in a list view.
<peer-name>	Detailed information on the peer with the given name.
address <peer-address>	Detailed information on the peer with the given IP address.
history	Displays BGP peer history information such as the peer state down reasons.
history <peer-address>	Displays BGP peer history information such as the peer state down reasons for a specified peer.
instance <instance-name>	Summary of all BGP peers in the given instance.
instance <instance-name> detail	Detailed information on all BGP peers in the given instance.
instance <instance-name> detail <peer-name>	Detailed information on the peer with the given name in the given instance.
instance <instance-name> detail address <peer-address>	Detailed information on the peer with the given IP address in the given instance.
statistics	Received and sent BGP prefixes per AFI/SAFI for all peers in all instances.
statistics peer <peer-name>	Received and sent BGP prefixes per AFI/SAFI for the peer with the given name.
statistics peer address <peer-address>	Received and sent BGP prefixes per AFI/SAFI for the peer with the given IP address.

Option	Description
statistics instance <instance-name> peer <peer-name>	Received and sent BGP prefixes per AFI/SAFI for the peer with the given name in the given instance.
statistics instance <instance-name> peer address <peer-address>	Received and sent BGP prefixes per AFI/SAFI for the peer with the given IP address in the given instance.

### Example 1: BGP Peer Information for instance **default**

```

supervisor@rtbrick: op> show bgp peer instance default
Instance: default
  Peer      Remote AS   State           Up/Down Time   PfxRcvd   PfxSent
  spine1    4200000000 Established     0d:00h:59m:45s 55          77
  spine1    4200000000 Established     0d:00h:59m:48s 55          77
supervisor@rtbrick: op>
    
```

### Example 2: Detailed view of BGP Peer Information

```

supervisor@rtbrick: op> show bgp peer detail
Peer: spine1, Peer IP: fe80::9a19:2cff:fe99:4701, Remote AS: 4200000000, Local:
fe80::9a19:2cff:fe36:3e03, Local AS: 4200000004, Any AS: False
Type: ebgp, State: Established, Up/Down Time: 0d:01h:00m:40s
Discovered on interface: ifl-0/0/2/1
Last transition: Thu Apr 18 04:50:56 GMT +0000 2024, Flap count: 0
Peer ID      : 192.1.0.1, Local ID : 192.1.0.4
Instance     : default, Peer group: spine
6PE enabled  : False
Timer values:
  Peer keepalive : 30s, Local keepalive: 30s
  Peer holddown  : 90s, Local holddown : 90s
  Connect retry  : 30s
Timers:
  Connect retry timer : 0s
  Keepalive timer     : expires in 21s 796304us
  Holddown timer      : expires in 1m 13s 560627us
NLRIs:
  Sent           : ['l2vpn-evpn', 'ipv4-unicast', 'ipv6-unicast', 'ipv4-vpn-
unicast', 'ipv6-vpn-unicast', 'ipv4-vpn-multicast', 'l2vpn-vpls', 'ipv4-labeled-
unicast', 'ipv6-labeled-unicast']
  Received       : ['l2vpn-evpn', 'ipv4-unicast', 'ipv6-unicast', 'ipv4-vpn-
unicast', 'ipv6-vpn-unicast', 'ipv4-vpn-multicast', 'l2vpn-vpls', 'ipv4-labeled-
unicast', 'ipv6-labeled-unicast']
  Negotiated     : ['l2vpn-evpn', 'ipv4-unicast', 'ipv6-unicast', 'ipv4-vpn-
unicast', 'ipv6-vpn-unicast', 'ipv4-vpn-multicast', 'l2vpn-vpls', 'ipv4-labeled-
unicast', 'ipv6-labeled-unicast']
Capabilities:
  Addpath sent           : None
  Addpath received       : None
  Addpath negotiated     : None
  Extended nexthop sent  : ['ipv4-unicast', 'ipv4-vpn-unicast', 'ipv4-
    
```

```

vpn-multicast', 'ipv4-labeled-unicast']
  Extended nexthop received      : ['ipv4-unicast', 'ipv4-labeled-unicast',
'ipv4-vpn-multicast', 'ipv4-vpn-unicast']
  Extended nexthop negotiated    : ['ipv4-unicast', 'ipv4-labeled-unicast',
'ipv4-vpn-multicast', 'ipv4-vpn-unicast']
  Capabilities:
    Feature           Sent      Received      Negotiated
  Route refresh      True      True          True
    4 byte AS         True      True          True
  Graceful restart   False     False         False
  Link local only    False     False         False
  Prefix Limit:
  End of RIB:
  Address family      Sent                                     Received
  IPv4 unicast        Thu Apr 18 04:50:59 GMT +0000 2024  Thu Apr 18
04:50:59 GMT +0000 2024
  IPv4 labeled-unicast Thu Apr 18 04:50:59 GMT +0000 2024  Thu Apr 18
04:50:59 GMT +0000 2024
  IPv6 unicast        Thu Apr 18 04:50:59 GMT +0000 2024  Thu Apr 18
04:50:59 GMT +0000 2024
  IPv6 labeled-unicast Thu Apr 18 04:50:59 GMT +0000 2024  Thu Apr 18
04:50:59 GMT +0000 2024
  IPv4 VPN-unicast    Thu Apr 18 04:50:59 GMT +0000 2024  Thu Apr 18
04:50:59 GMT +0000 2024
  IPv6 VPN-unicast    Thu Apr 18 04:50:59 GMT +0000 2024  Thu Apr 18
04:50:59 GMT +0000 2024
  IPv4 VPN-multicast  Thu Apr 18 04:50:59 GMT +0000 2024  Thu Apr 18
04:50:59 GMT +0000 2024
  L2VPN VPLS         Thu Apr 18 04:50:59 GMT +0000 2024  Thu Apr 18
04:50:59 GMT +0000 2024
  L2VPN EVPN         Thu Apr 18 04:50:59 GMT +0000 2024  Thu Apr 18
04:50:59 GMT +0000 2024
  Message stats:
  Session stats:
  Direction   Open      Update      Keepalive    Notify      Route
refresh
  Input       0         0           72           0           0
  Output      0         0           71           0           0
  Total stats:
  Input       0         0           72           0           0
  Output      0         0           71           0           0
  Route stats:
  Address family      Received      Sent          Prefix limit Idle
timeout
  IPv4 unicast        0             0             0             0
  IPv4 labeled-unicast 0             0             0             0
  IPv6 unicast        0             0             0             0
  IPv6 labeled-unicast 0             0             0             0
  IPv4 VPN-unicast    0             0             0             0
  IPv6 VPN-unicast    0             0             0             0
  IPv4 VPN-multicast  0             0             0             0
  L2VPN VPLS         0             0             0             0
  L2VPN EVPN         0             0             0             0
<...>
    
```

### Example 3: BGP Peer Statistics for a specific peer

```

supervisor@rtbrick: op> show bgp peer statistics peer address
fe80::781a:c6ff:fec0:1
    
```

```
Instance: default
```

Peer	AFI	SAFI	PfxRcvd	PfxSent
spine1	ipv4	unicast	4	5
	ipv4	labeled-unicast	4	5
	ipv6	unicast	4	5
	ipv6	labeled-unicast	4	5
	ipv4	vpn-unicast	14	18
	ipv6	vpn-unicast	14	18
	ipv4	multicast	0	0
	ipv4	vpn-multicast	4	7
	l2vpn	vpls	3	6
	l2vpn	evpn	4	8

### Example 4: BGP Peer history for a specified peer

```
supervisor@rtbrick.net: op> show bgp peer history peer address 192:168::40
Instance: ip2vrf
Peer Address          Source Address          Type          Last
Reset Reason
192:168::40          192:168:5::20          FSM Error     FSM
Error, Sub-Code: Unexpected message in OpenSent State
```

## BGP RIB-in

This command displays the received routes.

### Syntax:

**show bgp rib-in** <option>

Option	Description
-	Without any option, the command displays information on the received BGP routing table on all instances in a summary table format.
<afi>	BGP routing table summary for the given address family (AFI), all sub-address families and all instances. Supported AFI values are 'ipv4', 'ipv6' and <b>l2vpn</b> .
<afi> <safi>	BGP routing table summary for the given address family (AFI) and sub-address family (SAFI), and all instances. Supported SAFI values are <b>evpn</b> , 'labeled-unicast', 'unicast', 'vpn-multicast', 'vpn-unicast', and <b>vpls</b> .

Option	Description
<afi> <safi> detail	Detailed list view of the BGP routing table for the given address family (AFI) and sub-address family (SAFI), and all instances.
<afi> <safi> <prefix>	BGP routing table entry for the given prefix and all instances.
<afi> <safi> instance <instance-name>	BGP routing table summary for the given AFI, SAFI, and instance.
<afi> <safi> instance <instance-name> detail	Detailed list view of BGP routing table for the given AFI, SAFI, and instance.
<afi> <safi> instance <instance-name> <prefix>	BGP routing table entry for the given prefix and instance.
<afi> <safi> community <community-name>	BGP community details for the given AFI, SAFI, and instance.
<afi> <safi> error	BGP route with error status for the given AFI, SAFI, and instance.
<afi> <safi> peer <name> / peer address <ip>	Peer name or address

Example 1: Summary view of the BGP rib-in where you can find received information for the BGP L2VPN instances like *l2vpn\_ce1*, *l2vpn\_ce2*, and *l2vpn\_ce3*.

```

supervisor@rtbrick: op> show bgp rib-in
Flags: & - Imported, ! - Error
Instance: default, AFI: ipv6, SAFI: unicast
  Hostname: Local, Peer IP: 0.0.0.0
  Source IP: 0.0.0.0, Total routes: 3
    Prefix                               Next Hop                                MED      Lpref
AS Path  Status
  192:1::3/128                                0      100
-      Valid
  192:1::5/128                                0      100
-      Valid
  192:1::6/128                                0      100
-      Valid
  Hostname: spine1, Peer IP: fe80::781a:c6ff:fec0:1
  Source IP: fe80::7857:d6ff:fec0:0, Total routes: 1
    Prefix                               Next Hop                                MED      Lpref
AS Path  Status
  192:1::1/128                                fe80::781a:c6ff:fec0:1      0      -
4200000000 Valid
Instance: default, AFI: ipv6, SAFI: labeled-unicast
  Hostname: Local, Peer IP: 0.0.0.0
  Source IP: 0.0.0.0, Total routes: 3
    Prefix                               Next Hop                                MED      Lpref
AS Path  Status
  192:1::3/128                                0      100
-      Valid
  192:1::5/128                                0      100
-      Valid
  
```

```

192:1::6/128
- Valid
  Hostname: spine1, Peer IP: fe80::781a:c6ff:fec0:1
  Source IP: fe80::7857:d6ff:fec0:0, Total routes: 1
  Prefix
AS Path      Status      Next Hop      MED      Lpref
192:1::1/128
4200000000 Valid
Instance: l2vpn_cel, AFI: l2vpn, SAFI: vpls-vpws
  Hostname: Local, Peer IP: 0.0.0.0
  Source IP: 0.0.0.0, Total routes: 1
  Prefix
AS Path      Status      Next Hop      MED      Lpref
00.00.00.00.00.00.00.00.00.00:300/112
- Valid
Instance: l2vpn_ce2, AFI: l2vpn, SAFI: vpls-vpws
  Hostname: Local, Peer IP: 0.0.0.0
  Source IP: 0.0.0.0, Total routes: 1
  Prefix
AS Path      Status      Next Hop      MED      Lpref
00.00.00.00.00.00.00.00.00.00:310/112
- Valid
Instance: l2vpn_ce3, AFI: l2vpn, SAFI: vpls-vpws
  Hostname: Local, Peer IP: 0.0.0.0
  Source IP: 0.0.0.0, Total routes: 1
  Prefix
AS Path      Status      Next Hop      MED      Lpref
00.00.00.00.00.00.00.00.00.00:400/112
- Valid
Instance: default, AFI: l2vpn, SAFI: vpls
  Hostname: spine1, Peer IP: fe80::781a:c6ff:fec0:1
  Source IP: fe80::7857:d6ff:fec0:0, Total routes: 3
  Prefix
AS Path      Status      Next Hop      MED      Lpref
00.00.00.00.00.00.00.00.00.00:301/112      192:1::1      0      -
4200000000 Valid
00.00.00.00.00.00.00.00.00.00:311/112      192:1::1      0      -
4200000000 Valid
00.00.00.00.00.00.00.00.00.00:401/112      192:1::1      0      -
4200000000 Valid
<...>
    
```

Example 2: Summary view of the BGP rib-in where you can find received information for address family **l2vpn vpls**.

```

supervisor@rtbrick: op> show bgp rib-in l2vpn vpls
Flags: & - Imported, ! - Error
Instance: default, AFI: l2vpn, SAFI: vpls
  Hostname: spine1, Peer IP: fe80::9a19:2cff:fe99:4701
  Source IP: fe80::9a19:2cff:fe36:3e03, Total routes: 3
  Prefix
AS Path      Status      Next Hop      MED      Lpref
00.00.00.00.00.00.00.00.00.00:301/112      192:1::1      0      -
4200000000, 4200000003 Valid
00.00.00.00.00.00.00.00.00.00:311/112      192:1::1      0      -
4200000000, 4200000003 Valid
00.00.00.00.00.00.00.00.00.00:401/112      192:1::1      0      -
4200000000, 4200000003 Valid
    
```

Example 3: Summary view of the BGP rib-in with the error flag.

```

supervisor@rtbrick>rtbrick.net: op> show bgp rib-in ipv4 unicast peer address
12.0.0.2
Flags: & - Imported, ! - Error
Instance: default, AFI: ipv4, SAFI: unicast
  Hostname: P1, Peer IP: 12.0.0.2
    
```

```
Source IP: 12.0.0.1, Total routes: 4
```

Flags	Prefix	Next Hop	MED	Lpref	AS Path
	12.0.0.0/24	12.0.0.2	0	-	4200000002
	12.1.0.0/24	12.0.0.2	0	-	4200000002
	192.168.0.20/32	12.0.0.2	0	-	4200000002
	192.168.0.21/32	12.0.0.2	0	-	4200000002

## BGP FIB

The 'show bgp fib' commands display the BGP forwarding table.

### Syntax:

**show bgp fib** <option>

Option	Description
-	Without any option, the commands display the BGP forwarding table for all address families and all instances in a summary table format.
<afi>	BGP forwarding table summary for the given address family (AFI), all sub-address families and all instances. Supported AFI values are <b>l2vpn</b> , 'ipv4' and 'ipv6'.
<afi> <safi>	BGP forwarding table summary for the given address family (AFI) and sub-address family (SAFI), and all instances. Supported SAFI values are 'unicast', 'labeled-unicast', 'vpn-multicast', 'vpn-unicast', 'evpn- vpws', and 'vpls- vpws'.
<afi> <safi> detail	Detailed list view of the BGP forwarding table for the given address family (AFI) and sub-address family (SAFI), and all instances.
<afi> <safi> <prefix>	BGP forwarding table entry for the given prefix and all instances.
<afi> <safi> instance <instance-name>	BGP forwarding table summary for the given AFI, SAFI, and instance.
<afi> <safi> instance <instance-name> detail	Detailed list view of BGP forwarding table for the given AFI, SAFI, and instance.
<afi> <safi> instance <instance-name> <prefix>	BGP forwarding table entry for the given prefix and instance.

```

supervisor@rtbrick: op> show bgp fib
Instance: default, AFI: ipv6, SAFI: unicast
  Prefix                Preference  Out Label  Next Hop
  192:1::1/128          20         -          fe80::781a:c6ff:fec0:1
Instance: default, AFI: ipv6, SAFI: labeled-unicast
  Prefix                Preference  Out Label  Next Hop
  192:1::1/128          20         -          fe80::781a:c6ff:fec0:1
Instance: l2vpn_ce1, AFI: l2vpn, SAFI: vpls-vpws
  Prefix                Preference  Out Label  Next Hop
  00.00.00.00.00.00.00.00.00:301/112  20         150000,bos:1  192:1::1
Instance: l2vpn_ce2, AFI: l2vpn, SAFI: vpls-vpws
  Prefix                Preference  Out Label  Next Hop
  00.00.00.00.00.00.00.00.00:311/112  20         110000,bos:1  192:1::1
Instance: l2vpn_ce3, AFI: l2vpn, SAFI: vpls-vpws
  Prefix                Preference  Out Label  Next Hop
  00.00.00.00.00.00.00.00.00:401/112  20         120000,bos:1  192:1::1
    
```

## BGP RIB-out

This command displays the routes that were advertised to peers.

### Syntax:

**show bgp rib-out** <option>

Option	Description
-	Without any option, the command displays advertised BGP routes for all instances.
<afi>	BGP routing table summary for the given address family (AFI), all sub-address families and all instances. Supported AFI values are <b>l2vpn</b> , 'ipv4' and 'ipv6'.
<afi> <safi>	BGP routing table summary for the given address family (AFI) and sub-address family (SAFI), and all instances. Supported SAFI values are <b>evpn</b> , 'unicast', 'labeled-unicast', 'multicast', 'vpn-unicast', and <b>vpls</b> .
<afi> <safi> detail	Detailed list view of the BGP routing table for the given address family (AFI) and sub-address family (SAFI), and all instances.
<afi> <safi> <prefix>	BGP routing table entry for the given prefix and all instances.
<afi> <safi> instance <instance-name>	BGP routing table summary for the given AFI, SAFI, and instance.
<afi> <safi> instance <instance-name> detail	Detailed list view of BGP routing table for the given AFI, SAFI, and instance.



Option	Description
<afi> <safi> instance <instance-name> <prefix>	BGP routing table entry for the given prefix and instance.
<afi> <safi> peer <name> / peer address <ip>	Peer name or address

### Example 1: Summary view of the routes advertised to a peer

```

supervisor@rtbrick: op> show bgp rib-out
Instance: default, AFI: ipv6, SAFI: unicast
Peer-group: spine, Sent routes: 4
  Prefix                                MED      Lpref      Origin      Next Hop
AS Path
  192:1::1/128                          0        -          Incomplete  -
4200000003, 4200000000
  192:1::3/128                          0        -          Incomplete  -
4200000003
  192:1::5/128                          0        -          Incomplete  -
4200000003
  192:1::6/128                          0        -          Incomplete  -
4200000003
Instance: default, AFI: ipv6, SAFI: labeled-unicast
Peer-group: spine, Sent routes: 4
  Prefix                                MED      Lpref      Origin      Next Hop
AS Path
  192:1::1/128                          0        -          Incomplete  -
4200000003, 4200000000
  192:1::3/128                          0        -          Incomplete  -
4200000003
  192:1::5/128                          0        -          Incomplete  -
4200000003
  192:1::6/128                          0        -          Incomplete  -
4200000003
Instance: default, AFI: l2vpn, SAFI: vpls
Peer-group: spine, Sent routes: 3
  Prefix                                MED      Lpref      Origin      Next Hop
AS Path
  00.00.00.00.00.00.00.00.00.00:300/112  0        -          Incomplete  192:1::3
4200000003
  00.00.00.00.00.00.00.00.00.00:310/112  0        -          Incomplete  192:1::3
4200000003, 4200000000
  00.00.00.00.00.00.00.00.00.00:400/112  0        -          Incomplete  192:1::3
4200000003
    
```

## BGP L2VPN

This command displays the BGP L2VPN information.

### Syntax:

**show bgp l2vpn** <option>

Option	Description
pseudowire	Displays pseudowire peer IP information for all instances.

Option	Description
pseudowire instance <name>	Displays pseudowire peer IP information for the specified instance.

Example: Display L2VPN pseudowire information for instance **l2vpn\_ce1**

```

supervisor@rtbrick: op> show bgp l2vpn pseudowire instance l2vpn_ce1
Instance: l2vpn_ce1, AFI: l2vpn, SAFI: vpls-vpws
Peer IP: 12.0.0.2
Route Distinguisher: 192.1.6.3:65006
Number of local interfaces: 1
Interface name      Prefix
Label              Push Label
ifl-0/1/7/100      00.00.00.00.00.00.00.00.00.00:300/112
label:150001,bos:1 label:150001
Status              Local SID  Remote SID  Pop
up                  300        301
    
```

Example: Display L2VPN pseudowire information

```

supervisor@rtbrick.net: cfg> show bgp l2vpn pseudowire
Instance: vrfl-blue, AFI: l2vpn, SAFI: evpn-vpws
Route Distinguisher: 192.168.3.10:65010
Number of local interfaces: 4
Interface name      Prefix
Label              Push Label
hostif-0/0/2/101    00.00.00.00.00.00.00.00.00.00:300/112
label:20018,bos:1  label:20017,bos:1
hostif-0/0/2/201    00.00.00.00.00.00.00.00.00.00:310/112
label:20019,bos:1  label:20018,bos:1
hostif-0/0/2/401    00.00.00.00.00.00.00.00.00.00:401/112
-
hostif-0/0/3/401    00.00.00.00.00.00.00.00.00.00:402/112
-
Status              Local SID  Remote SID  Pop
Up                  300        301
Up                  310        311
Up                  401        402 -
Up                  402        401 -
    
```

## 4. Layer 3 Services

### 4.1. L3VPN

#### 4.1.1. L3VPN Overview

L3VPN, or Layer 3 Virtual Private Network, is a type of MPLS VPN that operates on top of an IP/MPLS transport infrastructure. It allows customers to create secure and private layer 3(IP) connections over a shared infrastructure and provides seamless IP connectivity to the customer's multiple sites.

The key aspects of L3VPN are:

- **IP-Based Routing:** All the control plane communication in the L3VPN network is based on IP-based routing protocols, so there are dynamic updates, multihoming, fault detection, and optimal data routing.
- **Provider Edge (PE):** The Layer 3 device at the edge of the service provider network is called Provider Edge.
- **Customer Edge (CE):** The Layer 3 device at the edge of the customer network with its interface connected to the service provider is called the Customer Edge. Both PE and CE have IP connectivity between them, either through Routing Protocols or Static Routing. The PE device has a separate instance configured for each customer. An Instance is a virtual routing and forwarding table (VRF) along with customer-private routing protocols. The CE device is responsible for transferring all the routing information in the customer sites to the PE.
- **Encapsulation and Tunneling:** L3VPN uses the MPLS data plane encapsulation to securely transfer data between two PE routers in the service provider network.
- **VPN Instances:** Each customer has a separate instance (VPN routing and forwarding (VRF) ) in PE. This ensures that each customer's data remains separate and maintains data privacy.
- **Security and Privacy:** L3VPN, using the above techniques, such as Encapsulation, Tunneling, and VPN instances, provides isolation for each customer in the shared network.
- **Scalability and Flexibility:** L3VPN supports different network deployments

depending on customer requirements. Instances are deployed only on the Edges, so they can be easily scaled. Filtering based on Extended Communities Route targets provides flexibility at the policy level, so it is possible to create various VPN topologies, such as hub-and-spoke VPNs, etc.

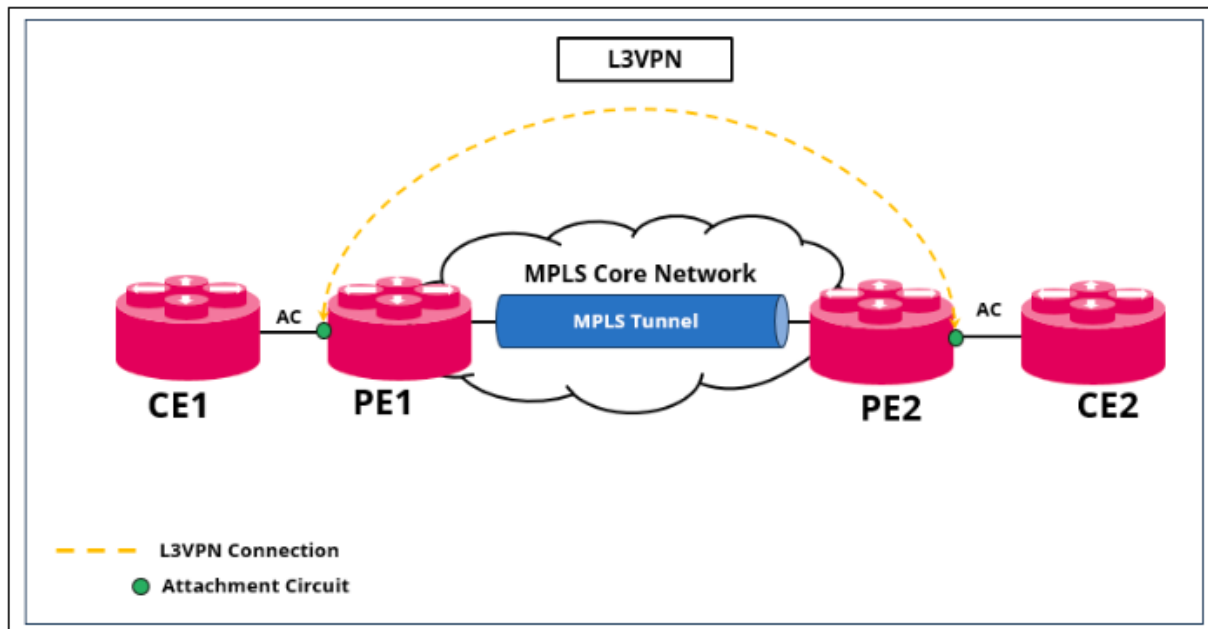

PE1 and PE2 are each configured with a BGP L3VPN instance connected to the customer edge devices (CEs). Both PE and CE have IP connectivity between them, either through Routing Protocols or Static Routing. Once PEs receive customer routes, they use Multi-Protocol BGP (MP-BGP) to exchange the routes between the PEs.

For example, when CE1 needs to transmit packets to CE2, then CE1 initiates a route lookup process to determine the next hop for getting to CE2. This destination route is exchanged in advance between PEs and CEs through the configured routing protocol. Upon obtaining the routing destination via PEs, the CEs proceed to transmit the packet to PEs. After the PEs receive packets from the CEs, they add the VPN labels which are advertised by the neighboring PEs for the destination route, and send them to the peer PEs using the MPLS label-switched path transport (LSP). After the other PEs receive the packet via the MPLS LSP, they pop the VPN labels of the packets and perform an IP route lookup on the L3VPN instances, and forward the packets to the destination CE2.

### Interprovider Layer 3 VPN options

Sometimes, a customer needs an L3 VPN between two locations where a given

Service Provider (SP) does not have coverage. To interconnect these customers, Layer 3 VPNs can be deployed in three different ways: Option A, Option B, and Option C.

- **Option A:** When dealing with another ISP, use eBGP, but place the BGP session within the customer's VRF. Essentially, treat the other service provider as if they were just another customer CE. This approach requires each customer's individual BGP and VRF configurations. However, it is ideal when you have no control over the other ISP's network.
- **Option B:** When setting up eBGP with the other ISP, make sure to use the global/default routing table. Each ASBR should advertise a unique label for every destination FEC in every VRF to the other ASBR. This process is similar to creating a label-switched path between the two ISPs.
- **Option C:** Configure eBGP between the ASBRs again, but this time using two planes: 1) The VPN unicast plane for exchanging VPN routes and plane 2 uses BGP Labeled Unicast, which enables PEs in one ISP to establish a label-switched path to the loopbacks of the PEs in the other ISP.

## Supported L3VPN Standards

RFC Number	Description
RFC 4364	BGP/MPLS IP Virtual Private Networks (VPNs)



RFC and draft compliance are partial except as specified.

## Supported Platforms

Not all features are necessarily supported on each hardware platform. Refer to the *Platform Guide* for the features and the sub-features that are or are not supported by each platform.

### 4.1.2. L3VPN Configuration

#### Configuration Hierarchy

The diagram below shows the L3VPN configuration hierarchy.

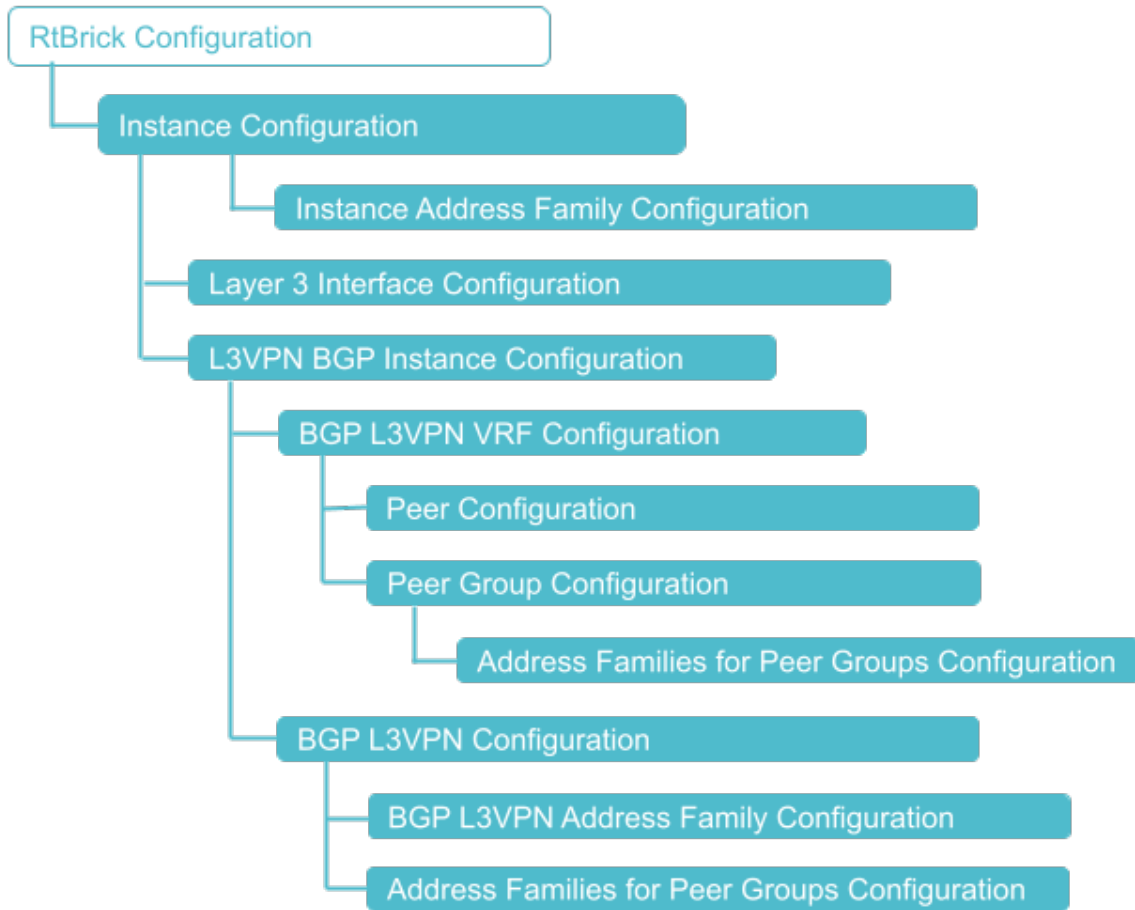

## Configuration Syntax and Commands

The following sections describe the BGP configuration syntax and commands.

### Instance Configuration

Each VPN is associated with one or more VPN routing and forwarding (VRF) instances. A VRF defines the VPN membership of a customer site attached to a PE router. A VRF consists of the following components:

- An IP version 4 (IPv4) 6 (IPv6) unicast routing table
- A private FIB table
- A set of interfaces that use the forwarding table
- A set of rules and routing protocol parameters that control the information that is included in the routing table

These components are collectively called a VRF instance.

The instance configuration hierarchy includes parameters that are required for or used by BGP, but that are not part of the BGP protocol configuration hierarchy itself. Route distinguishers and router IDs are configured directly at the instance hierarchy.

Syntax:

**set instance** <instance-name> <attribute> <value>

Attribute	Description
<instance-name>	Name of the routing instance
route-distinguisher <as-number ipv4-address:id>	<p>The route distinguisher (RD) uniquely defines routes within an IPv4 network. PE routers use route distinguishers to identify which VPN a packet belongs to. Supported formats are &lt;as-number:id&gt; or &lt;ipv4-address:id&gt;.</p> <div style="border-left: 1px solid black; padding-left: 10px; margin-top: 10px;">  <p>If you want to use the format &lt;as-number:id&gt; with a 4-byte ASN, specify it with an "L". For example, set instance services route-distinguisher 4200000000L:101</p> </div>
ipv4-router-id <ipv4-address>	The router ID of the routing instance.

The following example configures tge instance identifier.

```
set instance l3vpn-cel
set instance l3vpn-cel ipv4-router-id 172.16.3.10
set instance l3vpn-cel route-distinguisher 172.16.3.10:65001
commit
```

### Example: Instance Identifier Configuration

```
supervisor@PE1: cfg> show config instance l3vpn-cel
{
  "rtbrick-config:instance": [
    {
      "name": "l3vpn-cel",
      "ipv4-router-id": "172.16.3.10",
      "route-distinguisher": "172.16.3.10:65001",
      <...>
    }
  ]
}
```

## Address Families

At the instance address family hierarchy, you can enable or disable address families for the instance, and configure parameters like route targets.

Please note default settings depend on the instance. For the 'default' instance, the IPv4 and IPv6 unicast, multicast, and labeled unicast, as well as the MPLS unicast address families are enabled by default. For any non-default instance, no address family is enabled by default and needs to be enabled by configuration.

Syntax:

```
set instance <instance-name> address-family <afi> <safi> <attribute>
<value>
```

Attribute	Description
<afi>	Address family identifier (AFI). Supported values: ipv4, ipv6
<safi>	Subsequent address family identifier (SAFI). Supported values: unicast
route-target ( import   export ) <rt-value>	<p>Route targets (RT) are used to transfer routes between VPN instances. The RT identifies a subset of routes that should be imported to or exported from a particular VPN instance. You can configure an RT for importing or exporting routes or both.</p> <div style="border-left: 1px solid black; padding-left: 10px; margin-top: 10px;">  <p>If you want to use the format &lt;as-number:id&gt; with a 4-byte ASN, specify it with an "L". For example, set instance services address-family ipv4 unicast route-target export target:4200000000L:14</p> </div>



Attribute	Description
policy ( import   export ) <policy-name>	There are two attachment points for BGP policies. At this configuration hierarchy, you can attach import or export policies to the instance. These policies apply when routes are imported from the BGP protocol into the instance, or exported from the instance to the BGP protocol.

The following example configures the instance address families.

```
set instance l3vpn-cel address-family ipv4 unicast
set instance l3vpn-cel address-family ipv4 unicast route-target import
target:172.16.3.10:65001
set instance l3vpn-cel address-family ipv4 unicast route-target export
target:172.16.3.10:65001
set instance l3vpn-cel address-family ipv6 unicast
set instance l3vpn-cel address-family ipv6 unicast route-target import
target:172.16.3.11:65001
set instance l3vpn-cel address-family ipv6 unicast route-target export
target:172.16.3.11:65001
commit
```

### Example: Instance Address Family Configuration

```
supervisor@PE1: cfg> show config instance l3vpn-cel address-family
{
  "rtbrick-config:address-family": [
    {
      "afi": "ipv4",
      "safi": "unicast",
      "route-target": {
        "import": [
          "target:172.16.3.10:65001"
        ],
        "export": [
          "target:172.16.3.10:65001"
        ]
      }
    },
    {
      "afi": "ipv6",
      "safi": "unicast",
      "route-target": {
        "import": [
          "target:172.16.3.11:65001"
        ],
        "export": [
          "target:172.16.3.11:65001"
        ]
      }
    }
  ]
}
```

```
}

```

## Layer 3 Interface Configuration

L3VPN supports the configuration of Layer 3 logical interfaces.

### Syntax:

**set interface** <name> <attribute> <value>

Attribute	Description
unit <unit-id>	Create a logical interface (also referred to as a sub-interface) under the physical interface.
inner-vlan <inner-vlan-id>	Inner VLAN ID.
instance <instance>	Assign the logical interface to an instance.
vlan <outer-vlan-id>	Outer VLAN ID.

The following example shows the interface configuration.

```
set interface ifp-0/0/2 unit 0
set interface ifp-0/0/2 unit 0 instance l3vpn-cel
set interface ifp-0/0/2 unit 0 address ipv4 10.0.0.1/24
commit

```

### Example: Interface Configuration

```
supervisor@PE1: cfg> show config interface ifp-0/0/2
{
  "rtbrick-config:interface": [
    {
      "name": "ifp-0/0/2",
      "unit": [
        {
          "unit-id": 0,
          "instance": "l3vpn-cel",
          "address": {
            "ipv4": [
              {
                "prefix4": "10.0.0.1/24"
              }
            ]
          }
        }
      ]
    }
  ]
}

```

}

## Interface Address Configuration

This section describes how to configure interface IP addresses.

Syntax:

**set interface** <interface-name> **unit** <unit-id> **address** <afi> <attribute> <value>

Attribute	Description
<afi>	Address family identifier (AFI). Supported values: ipv4 and ipv6
<prefix4 prefix6>	Assign IPv4 or IPv6 address to the interface unit.

The following show the interface address configuration.

```
set interface ifp-0/0/2 unit 0
set interface ifp-0/0/2 unit 0 instance l3vpn-cel
set interface ifp-0/0/2 unit 0 address ipv4 10.0.0.1/24
commit
```

## Example: Interface Address Configuration

```
supervisor@PE1: cfg> show config interface ifp-0/0/2
{
  "rtbrick-config:interface": [
    {
      "name": "ifp-0/0/2",
      "unit": [
        {
          "unit-id": 0,
          "instance": "l3vpn-cel",
          "address": {
            "ipv4": [
              {
                "prefix4": "10.0.0.1/24"
              }
            ]
          }
        }
      ]
    }
  ]
}
```

## L3VPN BGP Instance Configuration

### BGP L3VPN VFT (Virtual Forwarding Table) Configuration

#### Syntax:

**set instance** <name> **protocol bgp** <attribute> <value>

Attribute	Description
<name>	Name of the routing instance
host-name <host-name>	The name of the BGP host, to a maximum of 64 characters
domain-name <domain-name>	The name of the BGP routing domain, to a maximum of 64 characters
address-family <afi>	Address family identifier (AFI). Supported value: ipv4, ipv6
address-family <afi> <safi>	Subsequent address family identifier (SAFI). Supported value: unicast
local-as <as-number>	The AS number in four-byte format. The numbers allowed are from 1 to 4294967295.
med <med-value>	The BGP Multi-Exit Discriminator (MED) value. The numbers allowed are from 0 to 4294967295. When an AS has multiple links to another AS, the MED value is used to determine the exit to use to reach the other AS.
router-id <router-id>	Router identifier in IPv4 format
timer hold-time <seconds>	Hold timer in seconds. The valid range is 5 to 65535.
timer keepalive <seconds>	Keep a live timer in seconds. The valid range is 5 to 65535.
redistribute <source>	Enable the redistribution feature to dynamically inject specific types of routes into the BGP protocol. Supported route sources are <b>direct</b> , <b>igmp</b> , <b>ipoe</b> , <b>isis</b> , <b>ospf</b> , <b>pim</b> , <b>ppp</b> , <b>static</b> , and <b>arp-nd</b> .
redistribute <source> policy <policy>	Attach a policy to the redistribution process

The following example configures BGP L3VPN VFT (Virtual Forwarding Table).

```
set instance l3vpn-cel protocol bgp domain-name PE1-AS1
set instance l3vpn-cel protocol bgp hostname PE1-AS1
set instance l3vpn-cel protocol bgp local-as 65001
set instance l3vpn-cel protocol bgp router-id 172.16.3.10
set instance l3vpn-cel protocol bgp address-family ipv4 unicast
set instance l3vpn-cel protocol bgp address-family ipv6 unicast
commit
```

Example: BGP L3VPN VFT (Virtual Forwarding Table)

```
supervisor@PE1: cfg> show config instance l3vpn-cel protocol bgp
{
  "rtbrick-config:bgp": {
    "domain-name": "PE1-AS1",
    "hostname": "PE1-AS1",
    "local-as": 65001,
    "router-id": "172.16.3.10",
    "address-family": [
      {
        "afi": "ipv4",
        "safi": "unicast"
      },
      {
        "afi": "ipv6",
        "safi": "unicast"
      }
    ]
  }
}
<...>
```

## Peer Configuration

Once peer groups have been defined, BGP peers can be configured at the peer configuration hierarchy. A peer can be specified by address, or by interface when using IPv6 auto-discovered neighbors and link-local addresses. Furthermore, it is possible to configure TCP authentication and bind it to a peer.

Syntax to configure a BGP peer by address:

```
set instance <instance-name> protocol bgp peer ( ipv4 | ipv6) <peer-address>
<update-source> peer-group <peer-group>
```

Syntax to configure a BGP peer using IPv6 link-local addresses:

```
set instance <instance-name> protocol bgp peer interface <name> peer-group
<peer-group>
```

Syntax to configure TCP Authentication for BGP peers:

**set instance** <instance-name> **protocol bgp peer** (ipv4 | ipv6) <peer-address> <update-source> **authentication-id** <authentication-id>

Attribute	Description
interface <name>	Enable BGP peer using IPv6 link-local addresses
ipv4 <peer-address>	IPv4 address of a BGP peer
ipv6 <peer-address>	IPv6 address of a BGP peer
allow-as-in <value>	Specify the value for allow-as-in. Allowed range of value 1 - 10.
<update-source>	Local IP address to be used for the peering
peer-group <peer-group>	Assign the peer to a peer group
authentication-id <authentication-id>	Authentication identifier

The following example configures a peer.

```
set instance l3vpn-cel protocol bgp peer ipv4 10.0.0.9 10.0.0.1
set instance l3vpn-cel protocol bgp peer ipv4 10.0.0.9 10.0.0.1 peer-group cel
commit
```

### Example: Peer Configuration

```
supervisor@PE1: cfg> show config instance l3vpn-cel protocol bgp peer
{
  "rtbrick-config:peer": {
    "ipv4": [
      {
        "peer-address": "10.0.0.9",
        "update-source": "10.0.0.1",
        "peer-group": "cel"
      }
    ]
  }
}
```

### Peer Group Configuration

In BGP, neighbor peers with the same update policies can be grouped to simplify the initial configuration and updates. Peers share the same policies such as route maps, distribution lists, filter lists, update sources, and so on, so peer groups only

need one configuration statement for these values.

Syntax:

```
set instance <instance-name> protocol bgp peer-group <peer-group-name>
<attribute> <value>
```

Attribute	Description
local-as <as-number>	Local AS number for the peer group
remote-as <as-number>	Remote AS number for the peer group
any-as <true   false>	Enable dynamic AS negotiation for this peer group
ebgp-multihop <hop-count>	By default, the maximum number of hops between eBGP peers is 1 (direct connection). This hop count overrides the default behavior allowing connectivity between eBGP peers not directly connected.

The following example configures a peer group.

```
set instance l3vpn-cel protocol bgp peer-group cel
set instance l3vpn-cel protocol bgp peer-group cel remote-as 65009
commit
```

### Example: Peer Group Configuration

```
supervisor@PE1: cfg> show config instance l3vpn-cel protocol bgp peer-group
{
  "rtbrick-config:peer-group": [
    {
      "pg-name": "cel",
      "remote-as": 65009,
      <...>
    }
  ]
}
```

## Configuring Address Families for Peer Groups

At this configuration hierarchy, you can enable the address families that shall be supported for the group peers, and enable features specific to the address family.

Syntax:

```
set instance <instance-name> protocol bgp peer-group <peer-group-name>
address-family <afi> <safi> <attribute> <value>
```

Attribute	Description
<afi>	Address family identifier (AFI). Supported values: ipv4, or ipv6
<safi>	Subsequent address family identifier (SAFI). Supported values: unicast
update-nexthop ( ipv4-address   ipv6-address ) <address>	BGP nexthop address for routes advertised to this peer group
policy ( import   export ) <policy-name>	Apply a routing policy to the peer group

The following example configures the address families that shall be supported for the group peers

```
set instance l3vpn-cel protocol bgp peer-group cel address-family ipv4 unicast
set instance l3vpn-cel protocol bgp peer-group cel address-family ipv6 unicast
commit
```

### Example: Peer Groups Address Family Configuration

```
supervisor@PE1: cfg> show config instance l3vpn-cel protocol bgp peer-group cel
address-family
{
  "rtbrick-config:address-family": [
    {
      "afi": "ipv4",
      "safi": "unicast"
    },
    {
      "afi": "ipv6",
      "safi": "unicast"
    }
  ]
}
```

## BGP L3VPN Configuration

### Configuring the BGP L3VPN Address Families

#### Syntax:

**set instance** <name> **protocol bgp address-family** <afi> <safi>



Attribute	Description
<name>	Name of the routing instance
<afi>	Address family identifier (AFI). Supported values: ipv4, ipv6
<safi>	Subsequent address family identifier (SAFI). Supported values: vpn-unicast

To configure BGP L3VPN on the default instance, enter the following command:

```
set instance default protocol bgp address-family ipv4 vpn-unicast
set instance default protocol bgp address-family ipv6 vpn-unicast
commit
```

### Example: BGP L3VPN Address Family Configuration

```
supervisor@PE1: cfg> show config instance default protocol bgp address-family
{
  "rtbrick-config:address-family": [
    {
      "afi": "ipv4",
      "safi": "vpn-unicast"
    },
    {
      "afi": "ipv6",
      "safi": "vpn-unicast"
    }
  ]
}
```

## Configuring Address Families for Peer Groups

### Syntax:

**set instance** <instance-name> **protocol bgp peer-group** <pg-name> **address-family** <afi> <safi> <attribute> <value>

Attribute	Description
<afi>	Address family identifier (AFI). Supported value: ipv4, ipv6.
<safi>	Subsequent address family identifier (SAFI). Supported value: vpn-unicast

Attribute	Description
add-path	Negotiate additional path capabilities with these peers, so that more than one path can be active to the peers in the group
default-information originate <true   false>	Generate and advertise a default route to peers in the group
extended-nexthop	Enable extended-next-hop encoding for BGP peer groups to allow the transfer of IPv4 prefixes over an IPv6 connection
nexthop-self <true   false>	Set the advertised BGP nexthop to yourself, this is the default for eBGP
nexthop-unchanged <true   false>	Do not modify the advertised BGP nexthop, this is the default for iBGP
update-nexthop ( ipv4-address   ipv6-address ) <address>	BGP nexthop address for routes advertised to this peer group
remove-private-as <true   false>	Remove private AS numbers from routes advertised to group peers
route-reflect-client <true   false>	Configure this peer as a route reflector client
policy ( import   export ) <policy-name>	Apply a routing policy to the peer group

To configure BGP L3VPN Peer Group on the **default** instance, enter the following command:

```
set instance default protocol bgp peer-group PE2-AS1 address-family ipv4 vpn-unicast
set instance default protocol bgp peer-group PE2-AS1 address-family ipv6 vpn-unicast
commit
```

### Example: Configuring Address Families for Peer Groups

```
supervisor@PE1: cfg> show config instance default protocol bgp peer-group PE2-AS1
{
  "rtbrick-config:peer-group": [
    {
      "pg-name": "PE2-AS1",
```

```

"remote-as": 4200000001,
"address-family": [
  {
    "afi": "ipv4",
    "safi": "vpn-unicast"
  },
  {
    "afi": "ipv6",
    "safi": "vpn-unicast"
  }
]
}
]
}

```

## 4.1.3. L3VPN Operational Commands

### L3VPN Show Commands

#### BGP Summary

This command displays BGP protocol parameters like attributes or timers that are generic to the BGP instance.

#### Syntax:

**show bgp summary** <option>

Attribute	Description
Option	Description
-	Without any option, the command displays the information for all instances.

#### Example 1: BGP summary for L3VPN VRF instance

```

supervisor@rtbrick: op> show bgp summary instance l3vpn-ce1
Instance: l3vpn-ce1
  General information
    Hostname: PE1, Domain name: PE1
    Local AS: 65001, Version: 4
    Local preference: 100, eBGP Protocol preference: 20, iBGP Protocol preference: 200
    Router ID: 172.16.3.10, Cluster ID: 172.16.3.10
    MED: 0, Enforce first AS: True
    Address families configured:
      ipv4: unicast
      ipv6: unicast
  Capabilities
    Route refresh: True, AS4: True, Graceful restart: False,
    Best route selection

```

```

Always compare MED: False, Ignore as path: False
Ignore local preference: False, Ignore origin: False
Ignore MED: False, Ignore route source: False
Ignore router ID: False, Ignore uptime: True
Ignore cluster length: False, Ignore peer IP: False
Route select parameter: 0

```

Timers

```
Connect retry: 30s, Keepalive: 30s, Holdtime: 90s
```

Statistics

```

Peers configured: 1, Peers auto discovery: 0
Peers in idle           : 0
Peers in connect       : 0
Peers in active        : 0
Peers in opensent     : 0
Peers in openconfirm  : 0
Peers in established   : 1

```

## Example 2: BGP summary for L3VPN default instance

```

supervisor@rtbrick: op> show bgp summary instance default
Instance: default
General information
  Hostname: PE1, Domain name: PE1-BGP-Peers
  Local AS: 4200000001, Version: 4
  Local preference: 100, eBGP Protocol preference: 20, iBGP Protocol preference: 200
  Router ID: 192.168.0.20, Cluster ID: 192.168.0.20
  MED: 0, Enforce first AS: True
  Address families configured:
    ipv4: vpn-unicast
    ipv6: vpn-unicast
Capabilities
  Route refresh: True, AS4: True, Graceful restart: False,
Best route selection
  Always compare MED: False, Ignore as path: False
  Ignore local preference: False, Ignore origin: False
  Ignore MED: False, Ignore route source: False
  Ignore router ID: False, Ignore uptime: True
  Ignore cluster length: False, Ignore peer IP: False
  Route select parameter: 0
Timers
  Connect retry: 30s, Keepalive: 30s, Holdtime: 90s
Statistics
  Peers configured: 1, Peers auto discovery: 0
  Peers in idle           : 0
  Peers in connect       : 0
  Peers in active        : 0
  Peers in opensent     : 0
  Peers in openconfirm  : 0
  Peers in established   : 1

```

## BGP Peer

The 'show bgp peer' commands display information on BGP peers.

### Syntax:

**show bgp peer** <option>

Option	Description
-	Without any option, the commands display all BGP peers in all instances in a summary table format.
detail	Detailed information on all BGP peers in all instances in a list view.
<peer-name>	Detailed information on the peer with the given name.
address <peer-address>	Detailed information on the peer with the given IP address.
history	Displays BGP peer history information such as the peer state down reasons.
history <peer-address>	Displays BGP peer history information such as the peer state down reasons for a specified peer.
instance <instance-name>	Summary of all BGP peers in the given instance.
instance <instance-name> detail	Detailed information on all BGP peers in the given instance.
instance <instance-name> detail <peer-name>	Detailed information on the peer with the given name in the given instance.
instance <instance-name> detail address <peer-address>	Detailed information on the peer with the given IP address in the given instance.
statistics	Received and sent BGP prefixes per AFI/SAFI for all peers in all instances.
statistics peer <peer-name>	Received and sent BGP prefixes per AFI/SAFI for the peer with the given name.
statistics peer address <peer-address>	Received and sent BGP prefixes per AFI/SAFI for the peer with the given IP address.
statistics instance <instance-name> peer <peer-name>	Received and sent BGP prefixes per AFI/SAFI for the peer with the given name in the given instance.
statistics instance <instance-name> peer address <peer-address>	Received and sent BGP prefixes per AFI/SAFI for the peer with the given IP address in the given instance.

### Example 1: BGP Peer Information for L3VPN VRF instance

```

supervisor@rtbrick: op> show bgp peer instance l3vpn-cel
Instance: l3vpn-cel
Peer                Remote AS   State        Up/Down Time      PfxRcvd
PfxSent
CE1                 65009      Established  0d:07h:04m:09s   7
14
    
```

### Example 2: BGP Peer Information for L3VPN default instance

```

supervisor@rtbrick: op> show bgp peer instance default
Instance: default
Peer                Remote AS   State        Up/Down Time      PfxRcvd
PfxSent
PE2                 4200000002 Established  0d:07h:03m:03s   7
14
    
```

### Example 3: Detailed view of BGP Peer Information for L3VPN VRF instance

```

supervisor@rtbrick: op> show bgp peer instance l3vpn-cel detail
Peer: CE1, Peer IP: 10.0.0.9, Remote AS: 65009, Local: 10.0.0.1, Local AS: 65001, Any AS: False
Type: ebgp, State: Established, Up/Down Time: Thu Dec 05 05:22:33 GMT +0000 2024, Reason: Cease, Sub-Code:
Admin reset
Discovered on interface: -
Last transition: Thu Dec 05 05:22:33 GMT +0000 2024, Flap count: 1
Peer ID      : 172.16.2.10, Local ID  : 172.16.3.10
Instance     : l3vpn-cel, Peer group: cel
6PE enabled  : False,
TTL Security : False, TTL Limit : -
Timer values:
Peer keepalive : 30s, Local keepalive: 30s
Peer holddown  : 90s, Local holddown : 90s
Connect retry  : 30s
Timers:
Connect retry timer : 0s
Keepalive timer     : expires in 3s 266331us
Holddown timer      : expires in 1m 26s 901069us
NLRIs:
Sent              : ['ipv4-unicast', 'ipv6-unicast']
Received          : ['ipv4-unicast', 'ipv6-unicast']
Negotiated        : ['ipv4-unicast', 'ipv6-unicast']
Capabilities:
Addpath sent      : None
Addpath received  : None
Addpath negotiated: None
Extended nexthop sent : None
Extended nexthop received : None
Extended nexthop negotiated : None
Capabilities:
Feature           Sent      Received  Negotiated
Route refresh     True      True      True
4 byte AS        True      True      True
Graceful restart  False     False     False
Link local only   False     False     False
Prefix Limit:
End of RIB:
Address family    Sent      Received
IPv4 unicast     Thu Dec 05 05:22:38 GMT +0000 2024  Thu Dec 05 05:22:38 GMT +0000 2024
IPv4 labeled-unicast never
IPv6 unicast     Thu Dec 05 05:22:38 GMT +0000 2024  Thu Dec 05 05:22:38 GMT +0000 2024
IPv6 labeled-unicast never
IPv4 VPN-unicast never
IPv6 VPN-unicast never
IPv4 flowspec    never
IPv6 flowspec    never
    
```

```

IPv4 VPN-multicast      never          never
L2VPN VPLS             never          never
L2VPN EVPN             never          never
RPKI Validation Stats:
Address family          Valid      Invalid   Unknown
IPv4 unicast            0          0         0
IPv6 unicast            0          0         0
Message stats:
Session stats:
Direction              Open       Update    Keepalive  Notify    Route refresh
Input                   1         4         1035       0         0
Output                  1         9         1032       0         0
Total stats:
Input                   2         8         1101       0         0
Output                  3         11        1097       1         0
Route stats:
Address family          Received   Sent      Prefix limit  Idle timeout
IPv4 unicast            4         4         0             0
IPv4 labeled-unicast   0         0         0             0
IPv6 unicast            3         3         0             0
IPv6 labeled-unicast   0         0         0             0
IPv4 VPN-unicast       0         0         0             0
IPv6 VPN-unicast       0         0         0             0
IPv4 VPN-multicast     0         0         0             0
L2VPN VPLS             0         0         0             0
L2VPN EVPN             0         0         0             0
IPv4 flowspec          0         0         0             0
IPv6 flowspec          0         0         0             0
    
```

#### Example 4: Detailed view of BGP Peer Information for L3VPN default instance

```

supervisor@rtbrick: op> show bgp peer instance default detail
Peer: PE2, Peer IP: 192.168.0.30, Remote AS: 4200000002, Local: 192.168.0.20, Local AS: 4200000001, Any AS:
False
Type: ebgp, State: Established, Up/Down Time: Thu Dec 05 05:24:03 GMT +0000 2024
Discovered on interface: -
Last transition: Thu Dec 05 05:24:03 GMT +0000 2024, Flap count: 0
Peer ID      : 192.168.0.30, Local ID  : 192.168.0.20
Instance     : default, Peer group: PE2
6PE enabled  : False,
TTL Security : False, TTL Limit : -
Timer values:
Peer keepalive : 30s, Local keepalive: 30s
Peer holddown  : 90s, Local holddown : 90s
Connect retry  : 30s
Timers:
Connect retry timer : 0s
Keepalive timer     : expires in 15s 663139us
Holddown timer      : expires in 1m 15s 207239us
NLRIs:
Sent               : ['ipv4-vpn-unicast', 'ipv6-vpn-unicast']
Received           : ['ipv4-vpn-unicast', 'ipv6-vpn-unicast']
Negotiated         : ['ipv4-vpn-unicast', 'ipv6-vpn-unicast']
Capabilities:
Addpath sent       : None
Addpath received   : None
Addpath negotiated : None
Extended nexthop sent : None
Extended nexthop received : None
Extended nexthop negotiated : None
Capabilities:
Feature            Sent      Received  Negotiated
Route refresh      True     True      True
4 byte AS          True     True      True
Graceful restart   False    False     False
Link local only    False    False     False
Prefix Limit:
End of RIB:
Address family     Sent      Received
IPv4 unicast       never     never
IPv4 labeled-unicast never     never
IPv6 unicast       never     never
IPv6 labeled-unicast never     never
    
```

```

IPv4 VPN-unicast      Thu Dec 05 05:24:08 GMT +0000 2024  Thu Dec 05 05:24:08 GMT +0000 2024
IPv6 VPN-unicast      Thu Dec 05 05:24:08 GMT +0000 2024  Thu Dec 05 05:24:08 GMT +0000 2024
IPv4 flowspec         never                                  never
IPv6 flowspec         never                                  never
IPv4 VPN-multicast    never                                  never
L2VPN VPLS           never                                  never
L2VPN EVPN            never                                  never
Message stats:
Session stats:
  Direction           Open           Update         Keepalive       Notify         Route refresh
  Input                1              9              1033            0              0
  Output               1              4              1035            0              0
Total stats:
  Input                1              9              1033            0              0
  Output               2              4              1035            0              0
Route stats:
  Address family      Received       Sent           Prefix limit    Idle timeout
  IPv4 unicast        0              0              0               0
  IPv4 labeled-unicast 0              0              0               0
  IPv6 unicast        0              0              0               0
  IPv6 labeled-unicast 0              0              0               0
  IPv4 VPN-unicast    4              4              0               0
  IPv6 VPN-unicast    3              3              0               0
  IPv4 VPN-multicast  0              0              0               0
  L2VPN VPLS         0              0              0               0
  L2VPN EVPN         0              0              0               0
  IPv4 flowspec       0              0              0               0
  IPv6 flowspec       0              0              0               0
    
```

## BGP RIB-in

This command displays the received routes.

### Syntax:

**show bgp rib-in** <option>

Option	Description
-	Without any option, the command displays information on the received BGP routing table on all instances in a summary table format.
<afi>	BGP routing table summary for the given address family (AFI), all sub-address families and all instances. Supported AFI values are 'ipv4', 'ipv6' and 'l2vpn'.
<afi> <safi>	BGP routing table summary for the given address family (AFI) and sub-address family (SAFI), and all instances. Supported SAFI values are 'evpn', 'labeled-unicast', 'unicast', 'vpn-multicast', 'vpn-unicast', and 'vpls'.



Option	Description
<afi> <safi> detail	Detailed list view of the BGP routing table for the given address family (AFI) and sub-address family (SAFI), and all instances.
<afi> <safi> <prefix>	BGP routing table entry for the given prefix and all instances.
<afi> <safi> instance <instance-name>	BGP routing table summary for the given AFI, SAFI, and instance.
<afi> <safi> instance <instance-name> detail	Detailed list view of BGP routing table for the given AFI, SAFI, and instance.
<afi> <safi> instance <instance-name> <prefix>	BGP routing table entry for the given prefix and instance.
<afi> <safi> community <community-name>	BGP community details for the given AFI, SAFI, and instance.
<afi> <safi> error	BGP route with error status for the given AFI, SAFI, and instance.
<afi> <safi> peer <name> / peer address <ip>	Peer name or address

Example 1: Summary view of the BGP rib-in where you can find received information for the L3VPN VRF instance `l3vpn-ce1` of IPv4/IPv6 prefixes.

```

supervisor@rtbrick: op> show bgp rib-in ipv4 unicast
Flags: & - Imported, ! - Error, N - RPKI Unknown, I - RPKI Invalid, V - RPKI Valid
Instance: l3vpn-ce1, AFI: ipv4, SAFI: unicast
  Hostname: ce1, Peer IP: 10.0.0.9
  Source IP: 10.0.0.1, Total routes: 4
  Flags Prefix                               Next Hop                                MED      Lpref
AS Path
65009      10.0.0.0/24                                10.0.0.9                                0        -
65009      172.16.2.10/32                             10.0.0.9                                0        -
65009      172.16.2.11/32                             10.0.0.9                                0        -
65009      172.16.2.12/32                             10.0.0.9                                0        -
65009

```

```

supervisor@rtbrick: op> show bgp rib-in ipv6 unicast
Flags: & - Imported, ! - Error, N - RPKI Unknown, I - RPKI Invalid, V - RPKI Valid
Instance: l3vpn-ce1, AFI: ipv6, SAFI: unicast
  Hostname: ce1, Peer IP: 10.0.0.9
  Source IP: 10.0.0.1, Total routes: 3
  Flags Prefix                               Next Hop                                MED      Lpref
AS Path
65009      172:16:2::10/128                           10.0.0.9                                0        -

```

```

65009      172:16:2::11/128      10.0.0.9      0      -
65009      172:16:2::12/128      10.0.0.9      0      -
65009
supervisor@S1-STD-1-1011>bm13-tst.fsn.rtbrick.net: op>
    
```

Example 2: Summary view of the BGP rib-in where you can find received information of L3VPN default instance of address-family IPv4/IPv6 vpn-unicast

```

supervisor@rtbrick: op> show bgp rib-in ipv4 vpn-unicast
Flags: & - Imported, ! - Error, N - RPKI Unknown, I - RPKI Invalid, V - RPKI Valid
Instance: default, AFI: ipv4, SAFI: vpn-unicast
  Hostname: PE2, Peer IP: 192.168.0.30
  Source IP: 192.168.0.20, Total routes: 4
    Flags Prefix                                Next Hop                                MED                                Lpref
AS Path
  10.0.1.0/24                                192.168.0.30                            0                                -
4200000002, 65029
  172.16.2.20/32                             192.168.0.30                            0                                -
4200000002, 65029
  172.16.2.21/32                             192.168.0.30                            0                                -
4200000002, 65029
  172.16.2.22/32                             192.168.0.30                            0                                -
4200000002, 65029
    
```

```

supervisor@rtbrick: op> show bgp rib-in ipv6 vpn-unicast
Flags: & - Imported, ! - Error, N - RPKI Unknown, I - RPKI Invalid, V - RPKI Valid
Instance: default, AFI: ipv6, SAFI: vpn-unicast
  Hostname: PE2, Peer IP: 192.168.0.30
  Source IP: 192.168.0.20, Total routes: 3
    Flags Prefix                                Next Hop                                MED                                Lpref
AS Path
  172:16:2::20/128                           192.168.0.30                            0                                -
4200000002, 65029
  172:16:2::21/128                           192.168.0.30                            0                                -
4200000002, 65029
  172:16:2::22/128                           192.168.0.30                            0                                -
4200000002, 65029
    
```

## BGP FIB

The 'show bgp fib' commands display the BGP forwarding table.

### Syntax:

**show bgp fib** <option>

Option	Description
-	Without any option, the commands display the BGP forwarding table for all address families and all instances in a summary table format.

Option	Description
<afi>	BGP forwarding table summary for the given address family (AFI), all sub-address families and all instances. Supported AFI values are 'l2vpn', 'ipv4' and 'ipv6'.
<afi> <safi>	BGP forwarding table summary for the given address family (AFI) and sub-address family (SAFI), and all instances. Supported SAFI values are 'unicast', 'labeled-unicast', 'vpn-multicast', 'vpn-unicast', 'evpn-vpws', and 'vpls-vpws'.
<afi> <safi> detail	Detailed list view of the BGP forwarding table for the given address family (AFI) and sub-address family (SAFI), and all instances.
<afi> <safi> <prefix>	BGP forwarding table entry for the given prefix and all instances.
<afi> <safi> instance <instance-name>	BGP forwarding table summary for the given AFI, SAFI, and instance.
<afi> <safi> instance <instance-name> detail	Detailed list view of BGP forwarding table for the given AFI, SAFI, and instance.
<afi> <safi> instance <instance-name> <prefix>	BGP forwarding table entry for the given prefix and instance.

### Example: Summary view of the BGP FIB

```

supervisor@rtbrick: op> show bgp fib
Instance: l3vpn-cel, AFI: ipv4, SAFI: unicast, Total Routes: 8
  Prefix                Preference    Out Label      Next Hop
  10.0.0.0/24           20           -              10.0.0.9
  10.0.1.0/24           20           20001,bos:1   192.168.0.30
  172.16.2.10/32       20           -              10.0.0.9
  172.16.2.11/32       20           -              10.0.0.9
  172.16.2.12/32       20           -              10.0.0.9
  172.16.2.20/32       20           20001,bos:1   192.168.0.30
  172.16.2.21/32       20           20001,bos:1   192.168.0.30
  172.16.2.22/32       20           20001,bos:1   192.168.0.30
Instance: default, AFI: ipv4, SAFI: vpn-unicast, Total Routes: 8
  Prefix                Preference    Out Label      Next Hop
  10.0.0.0/24           20           20001,bos:1   10.0.0.9
  10.0.1.0/24           20           20005,bos:1   192.168.0.30
  172.16.2.10/32       20           20001,bos:1   10.0.0.9
  172.16.2.11/32       20           20001,bos:1   10.0.0.9
  172.16.2.12/32       20           20001,bos:1   10.0.0.9
  172.16.2.20/32       20           20005,bos:1   192.168.0.30
  172.16.2.21/32       20           20005,bos:1   192.168.0.30
  172.16.2.22/32       20           20005,bos:1   192.168.0.30
Instance: l3vpn-cel, AFI: ipv6, SAFI: unicast, Total Routes: 6
  Prefix                Preference    Out Label      Next Hop
  172:16:2::10/128     20           -              10.0.0.9
    
```

```

172:16:2::11/128          20      -          10.0.0.9
172:16:2::12/128        20      -          10.0.0.9
172:16:2::20/128        20      20002,bos:1 192.168.0.30
172:16:2::21/128        20      20002,bos:1 192.168.0.30
172:16:2::22/128        20      20002,bos:1 192.168.0.30
Instance: default, AFI: ipv6, SAFI: vpn-unicast, Total Routes: 6
Prefix                    Preference  Out Label  Next Hop
172:16:2::10/128         20         20002,bos:1 10.0.0.9
172:16:2::11/128         20         20002,bos:1 10.0.0.9
172:16:2::12/128         20         20002,bos:1 10.0.0.9
172:16:2::20/128         20         20006,bos:1 192.168.0.30
172:16:2::21/128         20         20006,bos:1 192.168.0.30
172:16:2::22/128         20         20006,bos:1 192.168.0.30
    
```

## BGP RIB-out

This command displays the routes that were advertised to peers.

### Syntax:

**show bgp rib-out** <option>

Option	Description
-	Without any option, the command displays advertised BGP routes for all instances.
<afi>	BGP routing table summary for the given address family (AFI), all sub-address families and all instances. Supported AFI values are 'l2vpn', 'ipv4' and 'ipv6'.
<afi> <safi>	BGP routing table summary for the given address family (AFI) and sub-address family (SAFI), and all instances. Supported SAFI values are 'evpn', 'unicast', 'labeled-unicast', 'multicast', 'vpn-unicast', and 'vpls'.
<afi> <safi> detail	Detailed list view of the BGP routing table for the given address family (AFI) and sub-address family (SAFI), and all instances.
<afi> <safi> <prefix>	BGP routing table entry for the given prefix and all instances.
<afi> <safi> instance <instance-name>	BGP routing table summary for the given AFI, SAFI, and instance.
<afi> <safi> instance <instance-name> detail	Detailed list view of BGP routing table for the given AFI, SAFI, and instance.

Option	Description
<afi> <safi> instance <instance-name> <prefix>	BGP routing table entry for the given prefix and instance.
<afi> <safi> peer <name> / peer address <ip>	Peer name or address

Example 1: Summary view of the routes advertised to a L3VPN VRF instance peer of IPv4/IPv6

```

supervisor@rtbrick: op> show bgp rib-out ipv4 unicast
Instance: l3vpn-cel, AFI: ipv4, SAFI: unicast
Peer-group: cel, Sent routes: 8
  Prefix          MED    Lpref    Origin    Next Hop
  AS Path
10.0.0.0/24      0      -        Incomplete -
  [65001, 65009]
10.0.1.0/24      0      -        Incomplete -
  [65001, 4200000002, 65029]
172.16.2.10/32   0      -        Incomplete -
  [65001, 65009]
172.16.2.11/32   0      -        Incomplete -
  [65001, 65009]
172.16.2.12/32   0      -        Incomplete -
  [65001, 65009]
172.16.2.20/32   0      -        Incomplete -
  [65001, 4200000002, 65029]
172.16.2.21/32   0      -        Incomplete -
  [65001, 4200000002, 65029]
172.16.2.22/32   0      -        Incomplete -
  [65001, 4200000002, 65029]
    
```

```

supervisor@rtbrick: op> show bgp rib-out ipv6 unicast
Instance: l3vpn-cel, AFI: ipv6, SAFI: unicast
Peer-group: cel, Sent routes: 6
  Prefix          MED    Lpref    Origin    Next Hop
  AS Path
172:16:2::10/128 0      -        Incomplete -
  [65001, 65009]
172:16:2::11/128 0      -        Incomplete -
  [65001, 65009]
172:16:2::12/128 0      -        Incomplete -
  [65001, 65009]
172:16:2::20/128 0      -        Incomplete -
  [65001, 4200000002, 65029]
172:16:2::21/128 0      -        Incomplete -
  [65001, 4200000002, 65029]
172:16:2::22/128 0      -        Incomplete -
  [65001, 4200000002, 65029]
    
```

Example 2: Summary view of the routes advertised to L3VPN default instance of address-family IPv4/IPv6 vpn-unicast

```

supervisor@rtbrick: op> show bgp rib-out ipv4 vpn-unicast
    
```

Instance: default, AFI: ipv4, SAFI: vpn-unicast

Peer-group: PE2, Sent routes: 8

Prefix	MED	Lpref	Origin	Next Hop
AS Path				
10.0.0.0/24	0	-	Incomplete	-
[4200000001, 65009]				
10.0.1.0/24	0	-	Incomplete	-
[4200000001, 4200000002, 65029]				
172.16.2.10/32	0	-	Incomplete	-
[4200000001, 65009]				
172.16.2.11/32	0	-	Incomplete	-
[4200000001, 65009]				
172.16.2.12/32	0	-	Incomplete	-
[4200000001, 65009]				
172.16.2.20/32	0	-	Incomplete	-
[4200000001, 4200000002, 65029]				
172.16.2.21/32	0	-	Incomplete	-
[4200000001, 4200000002, 65029]				
172.16.2.22/32	0	-	Incomplete	-
[4200000001, 4200000002, 65029]				

supervisor@rtbrick: op> show bgp rib-out ipv6 vpn-unicast

Instance: default, AFI: ipv6, SAFI: vpn-unicast

Peer-group: PE2, Sent routes: 6

Prefix	MED	Lpref	Origin	Next Hop
AS Path				
172:16:2::10/128	0	-	Incomplete	-
[4200000001, 65009]				
172:16:2::11/128	0	-	Incomplete	-
[4200000001, 65009]				
172:16:2::12/128	0	-	Incomplete	-
[4200000001, 65009]				
172:16:2::20/128	0	-	Incomplete	-
[4200000001, 4200000002, 65029]				
172:16:2::21/128	0	-	Incomplete	-
[4200000001, 4200000002, 65029]				
172:16:2::22/128	0	-	Incomplete	-
[4200000001, 4200000002, 65029]				

# 5. Subscriber Management

## 5.1. Subscriber Management

### 5.1.1. Subscriber Management Overview

RtBrick's modular and scalable subscriber management, referred to as next-generation access infrastructure (ng-access), supports a range of access protocols including PPPoE, L2TPv2, IPoE (DHCPv4/v6), and RADIUS. This system is designed to deliver carrier-grade internet access services, with a focus on scalability, interoperability, and robustness. By providing support for multiple access protocols, RBFS ensures flexibility in deployment and compatibility with various network configurations, which is crucial for operators looking to provide consistent and high-quality services to their customers.

In this context, a subscriber refers to a customer connected through a Broadband Network Gateway (BNG). The BNG manages the connection by handling various protocols and sessions. Each subscriber is associated with a unique MAC address within a VLAN.

Providers that use separate VLANs for different services (e.g. internet and voice) may create multiple independent subscribers for the same customer or household. Although these subscribers might share certain QoS hierarchies, they are otherwise completely independent. Usually, VLANs used for services like IPTV or voice do not require subscriber management using static L3 interfaces with a traditional DHCP relay (non-subscriber).

A subscriber may have different forms of connectivity, depending on the access method used, such as PPPoE or IPoE. Thus, subscriber management involves overseeing customer connections, ensuring proper authentication, authorization, and accounting (AAA) of each subscriber, and maintaining the smooth operation of these sessions within a BNG. Effective subscriber management is key to maintaining high levels of customer satisfaction, as it directly impacts the reliability and performance of the internet services provided.

RBFS supports the following different protocol combinations to tailor an access network:

- **PPPoE Subscriber:** PPPoE/PPP Session and DHCPv6 (Prefix Delegation)

- **L2TP Subscriber:** PPPoE/PPP Session and L2TP Session
- **IPoE Subscriber:** DHCPv4 or DHCPv6

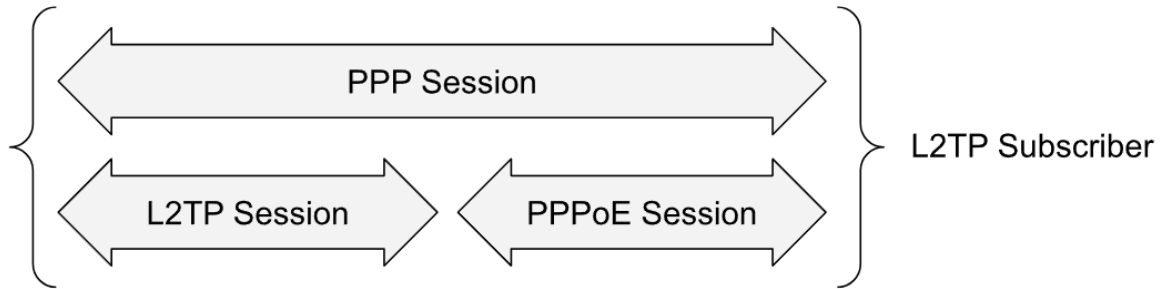

RtBrick's implementation utilizes a distributed architecture to enhance both scalability and stability. The distributed nature of this architecture allows multiple processes to manage different aspects of subscriber connections concurrently, reducing bottlenecks and ensuring that the system can handle a large number of subscribers efficiently. Carrier networks often need to interoperate with a wide variety of client devices from different vendors, each requiring adherence to established industry standards and RFCs. This complexity necessitates a robust and flexible approach to managing different network interactions.

Furthermore, these networks must cope with the diverse behaviors of numerous access devices, some of which may have non-standard implementations but cannot be easily replaced due to logistical or cost-related constraints. This adds to the complexity of subscriber management, as non-standard devices may behave unpredictably, requiring additional handling to maintain stable connections. To address these challenges, RBFS provides a protocol stack specifically tailored to offer best-in-class interoperability, ensuring reliable connectivity across a diverse range of client devices. This approach not only ensures that the network can interoperate with devices from various vendors but also allows for customization and adaptation to unique network scenarios.

Overall, RtBrick's subscriber management solution is designed to meet the needs of modern carrier networks by providing a flexible, scalable, and reliable platform for managing customer connections. Its distributed architecture, combined with support for a wide array of protocols and strong adherence to industry standards, makes it well-suited to handle the challenges posed by diverse client environments and evolving network requirements. This ensures that network operators can provide a seamless and high-quality experience to their customers, even in the face of varying device capabilities and non-standard behaviors.



## Supported Platforms

Not all features are necessarily supported on each hardware platform. Refer to the *Platform Guide* for the features and the sub-features that are or are not supported by each platform.

## Subscriber Management Daemons

There are four main daemons in the RtBrick distributed access architecture:

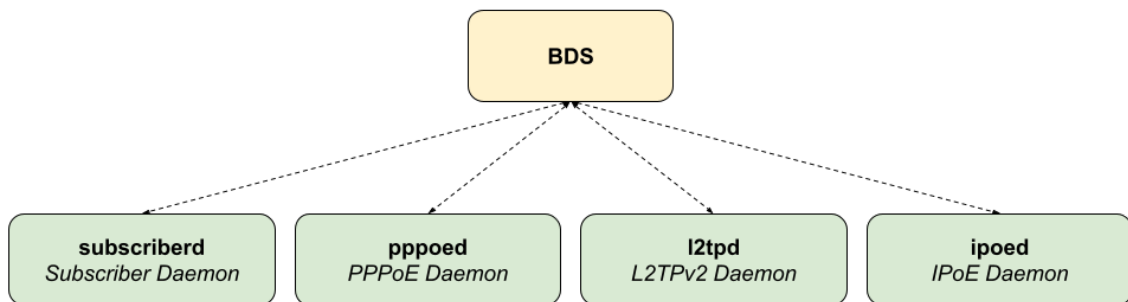

Figure 1. RBFS Access Infrastructure

The subscriber daemon (**subscriberd**) serves as the central component, managing the current subscriber state and handling Authentication, Authorization, and Accounting (AAA). The roles of each daemon are as follows:

- *subscriberd*: The subscriber daemon is responsible for subscriber management and AAA, which can be performed locally, via RADIUS, or through other methods. It also serves as the interface to the forwarding infrastructure, responsible to request per-subscriber QoS, filters, and more.
- *pppoed*: The PPPoE daemon handles PPPoE and PPP sessions for subscribers including subprotocols as ICMPv6 and DHCPv6 where the implementation for PPPoE differs compared to IPoE.
- *l2tpd*: The L2TP daemon is responsible to manage L2TPv2 tunnels and sessions.
- *ipoed*: The IPoE (IP-over-Ethernet) daemon handles protocols related to IPoE subscribers like DHCPv4 and DHCPv6.

## Subscriber Identifier

Each subscriber in RBFS is uniquely identified by a 64-bit number called **subscriber-id**, which remains unique across all RBFS processes and even across chassis in the

context of high availability.

This uniqueness is achieved through the following format:

- The first 4 bits identify the chassis, starting from 0.
- The next 4 bits identify the process:
  - 0x00 subscriberd (e.g. L2BSA, test, ...)
  - 0x01 pppoe (PPPoE sessions)
  - 0x02 l2tpd (reserved for LNS)
  - 0x03 ipoe (DHCPv4/v6)
- The following 8 bits are used to identify the application sharding instance. For example, instances such as `pppoe.1`, `pppoe.2`, and so on. While currently not in use, these bits provide the ability to partition load across multiple instances of the same process if needed to enhance scalability.
- The remaining 48 bits uniquely identify the subscriber, allowing for up to 281,474,976,710,656 unique subscribers per application instance before repetition, but even in the unlikely case of rollover, RBFS ensures uniqueness.

The subscriber portion always starts at '1', meaning that after a reboot, the subscriber identifiers will begin from the same value. These identifiers are consistent across multiple BNG, unless the `chassis-id` is explicitly set, which is required only for stateful high-availability configurations. Therefore, this number should not be used as a globally unique, non-repeating identifier in customer databases or management systems.

## VLAN Modes and Encapsulations

RBFS supports both 1:1 VLAN (VLAN-per-subscriber) and N:1 VLAN (shared VLAN) models for PPPoE and IPoE subscribers. It supports various VLAN encapsulations. Subscriber VLANs are dynamically created by specifying VLAN ranges with corresponding configurations. After successful authentication, RBFS generates the subscriber IFL, which includes the dynamic VLAN.

### 1:1 VLAN Model (VLAN-per-subscriber)

In the 1:1 VLAN model, each subscriber is assigned a unique VLAN. This provides a direct one-to-one mapping between VLANs and subscribers. New services can be added easily without affecting others. The 1:1 model is recommended because it is

simple and offers flexibility for features like backhauling, bitstream access, and QoS. As a result, more providers are migrating from the N:1 to the 1:1 VLAN model.

The following diagram illustrates a dedicated customer VLAN for each subscriber, showing the one VLAN per subscriber setup.

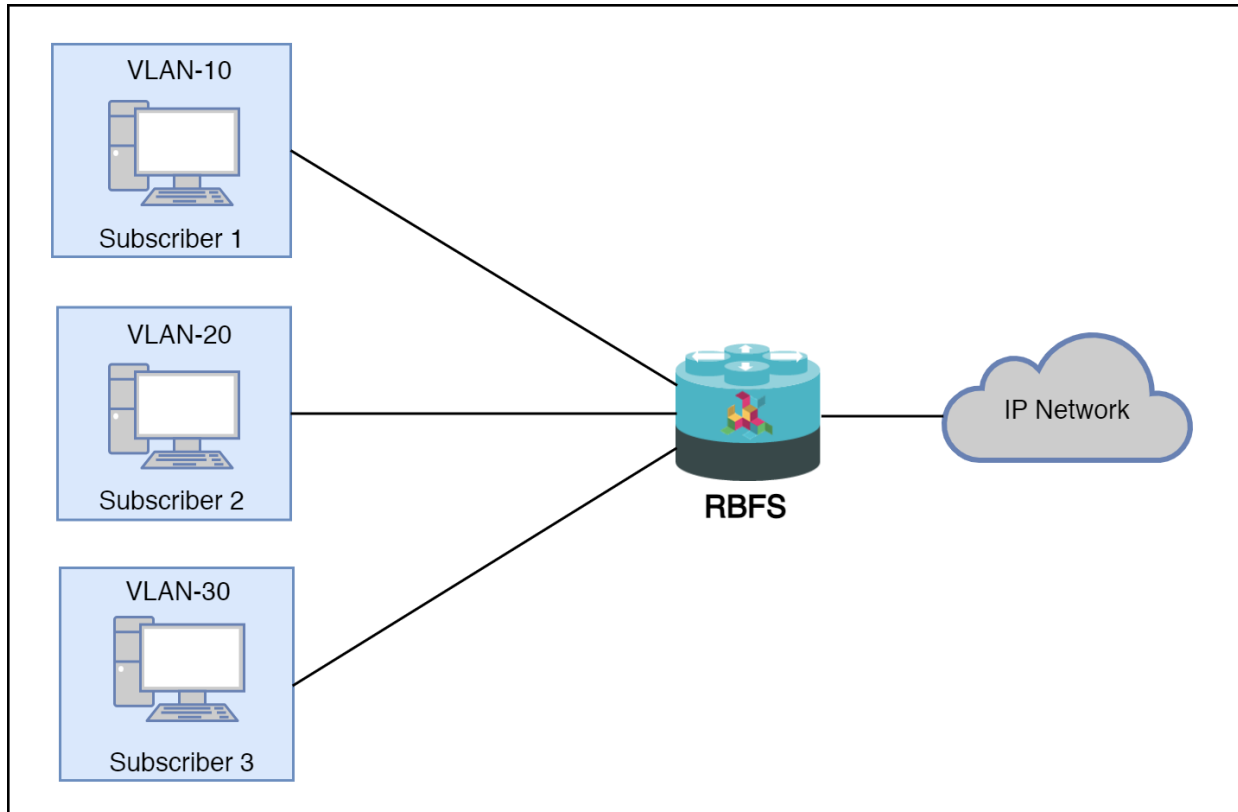

This model is defined by the maximum number of subscribers per VLAN in the access-interface configuration, which has a default value of 1. As a result, the 1:1 VLAN model is also the default in RBFS.

### **N:1 VLAN Model (shared-VLAN)**

The shared VLAN model offers many-to-one (N:1) subscriber-to-service connectivity, where multiple subscribers share a single VLAN. Unlike the 1:1 model, where each subscriber has a dedicated VLAN, the N:1 model provides a shared VLAN for many subscribers. A drawback of the shared VLAN model is the lack of logical isolation between subscribers at the VLAN level.

This results in certain limitations for IPoE subscribers, such as the lack of support for features like HTTP redirect, subscriber ACL, NAT, and IGMP for IPoE N:1 subscribers.

The following diagram shows a single VLAN that is connected to many subscribers.

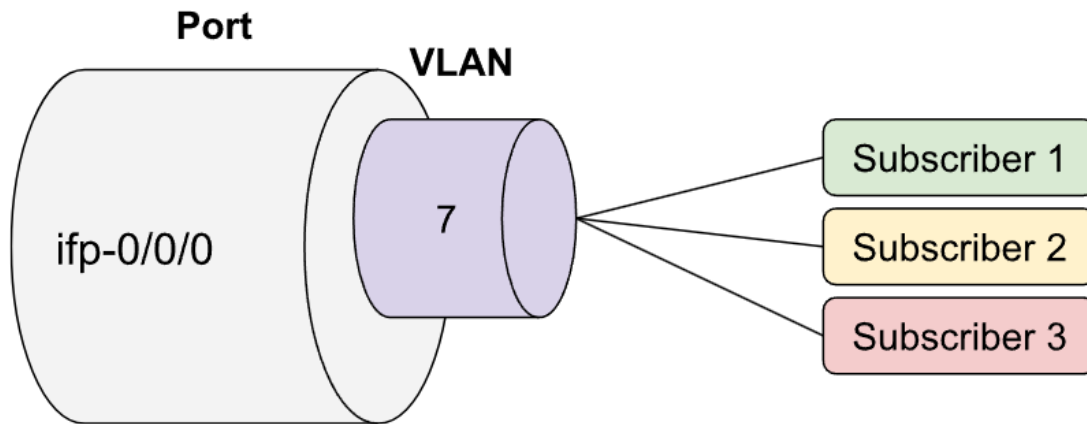

This model is defined by the maximum number of subscribers per VLAN in the access-interface configuration, which defaults to 1. Increasing this value beyond 1 enables the N:1 VLAN model for the corresponding access-interface.

### Auto-sensing VLAN TPID

In modern telecommunications networks, managing traffic for wholesale partners presents challenges, especially when the network operator lacks knowledge of the specific TPID (Tag Protocol Identifier) used in arriving traffic. This can lead to inefficiencies in network handling and potential service disruptions. To address this issue, RBFS supports Auto-sensing VLAN TPID which automatically detects and processes traffic tagged with different TPIDs. Specifically, this functionality will support both TPID 0x8100, commonly referred to as 802.1q, and TPID 0x88a8, referred to as 802.1ad.

The auto-sensing mechanism will utilize the initial subscriber-initiated packet, such as PPPoE Discovery packets (PADI, PADR), DHCP Discovery, or DHCPv6 Solicit packets, to determine the appropriate TPID. This ensures that the system can adapt to the tagging method used by the incoming traffic without requiring prior knowledge.

The default behavior is auto-sensing the TPID based on the first incoming packet, offering maximum flexibility. However, network operators will still have the option to explicitly define the **outer-vlan-encapsulation** in the access-interface configuration if required, overriding the auto-sensing functionality when needed. This approach enhances the scalability and efficiency of handling wholesale traffic across various network environments.

This applies to double-tagged profiles only! For single-tagged profiles, the default is 802.1q and cannot be changed, while for untagged profiles, no TPID check is performed as there is no VLAN present.

## **Authentication, Authorization, and Accounting Using RADIUS**

Remote Authentication Dial-In User Service (RADIUS) is a protocol that provides centralized Authentication, Authorization, and Accounting (AAA) for all types of subscribers. RADIUS servers can perform as authentication and accounting servers. Authentication servers maintain authentication records for subscribers.

The subscriber daemon optionally requests authentication using RADIUS access request messages before permitting subscribers access. Accounting servers handle accounting records for subscribers. The subscriber daemon transmits RADIUS accounting-on, start, interim, and stop messages to the servers. Accounting is the process of tracking subscriber activity and network resource usage in a subscriber session. This includes the session time called time accounting and the number of packets and bytes transmitted during the session called volume accounting. A RADIUS server can behave as a change of authorization (CoA) client, allowing dynamic changes for subscriber sessions. The subscriber daemon supports both RADIUS CoA messages and disconnects messages. CoA messages can modify the characteristics of existing subscriber sessions without loss of service, disconnect messages can terminate subscriber sessions. Each RADIUS request from the subscriber daemon includes the RADIUS accounting-session-id attribute (type 44) with a format that is configurable in the AAA configuration profile and includes at least the subscriber-id to identify the corresponding subscriber. The default format (<subscriber-id>.<timestamp>) includes also a Unix timestamp to ensure that the tuple of NAS-Identifier (e.g. hostname) and Accounting-Session-Id is global and unique to be usable as a key in RADIUS databases.

Additionally, to **subscriber-id** and **accounting-session-id** each subscriber consists also of a **subscriber-ifl** build based on physical port information and **subscriber-id** (ifp: ifp-0/0/1 and **subscriber-id**: 72339069014638610 **subscriber-ifl**: ppp 0/0/1/72339069014638610) which is required as a handle in the RBFS forwarding infrastructure.

```

Code: Access-Request (1)
Packet identifier: 0x22 (34)
Length: 416
Authenticator: e61a0dd74c74704f608688b08de1dfba
[The response to this request is in frame 12]
▼ Attribute Value Pairs
  ▶ AVP: t=User-Name(1) l=19 val=user1@rtbrick.com
  ▶ AVP: t=CHAP-Challenge(60) l=18 val=2f696f4e920b47cab869021feb2bf632
  ▶ AVP: t=CHAP-Password(3) l=19 val=02f439040e9feb7bbc9e7622a364344913
  ▶ AVP: t=NAS-IP-Address(4) l=6 val=1.1.1.1
  ▶ AVP: t=NAS-Identifier(32) l=5 val=BNG
  ▶ AVP: t=NAS-Port-Id(87) l=59 val=BNG#hostif-0/0/4#10#7#0.0.0.0/0.0.0.0 eth 1#DEU.RTBRICK.1
  ▶ AVP: t=NAS-Port(5) l=6 val=67149831
  ▶ AVP: t=NAS-Port-Type(61) l=6 val=Ethernet(15)
  ▶ AVP: t=Service-Type(6) l=6 val=Framed(2)
  ▶ AVP: t=Framed-Protocol(7) l=6 val=PPP(1)
  ▶ AVP: t=Acct-Session-Id(44) l=30 val=72339069014638895:1589876315
  ▶ AVP: t=Vendor-Specific(26) l=13 vnd=RtBrick Inc.(50058)
  ▶ AVP: t=Vendor-Specific(26) l=20 vnd=RtBrick Inc.(50058)
  ▶ AVP: t=Vendor-Specific(26) l=16 vnd=RtBrick Inc.(50058)
  ▶ AVP: t=Vendor-Specific(26) l=25 vnd=RtBrick Inc.(50058)
  ▼ AVP: t=Vendor-Specific(26) l=16 vnd=RtBrick Inc.(50058)
    Type: 26
    Length: 16
    Vendor ID: RtBrick Inc. (50058)
    ▶ VSA: t=RtBrick-Subscriber-Id(25) l=10 val=010100000000012f
  ▼ AVP: t=Vendor-Specific(26) l=35 vnd=RtBrick Inc.(50058)
    Type: 26
    Length: 35
    Vendor ID: RtBrick Inc. (50058)
    ▶ VSA: t=RtBrick-Subscriber-Id(26) l=29 val=ppp-0/0/4/72339069014638895
  ▶ AVP: t=Vendor-Specific(26) l=29 vnd=The Broadband Forum(3561)
  ▶ AVP: t=Calling-Station-Id(31) l=23 val=0.0.0.0/0.0.0.0 eth 1
  ▶ AVP: t=Vendor-Specific(26) l=21 vnd=The Broadband Forum(3561)
  ▶ AVP: t=Vendor-Specific(26) l=18 vnd=The Broadband Forum(3561)

```

Figure 2. RADIUS Access-Request



The subscriber-id is an unsigned 64-bit integer which is shown as a hex number in Wireshark.

Each subscriber is formed based on configuration profiles and individual settings retrieved via RADIUS. Conflicts between RADIUS-defined attributes and profile attributes are solved by prioritizing those received from RADIUS which is common best practice for broadband access concentrators. New subscribers are signalled via RADIUS access request and either accepted by RADIUS access-accept or rejected by RADIUS access-reject message from the RADIUS server. The RADIUS **access-accept** includes all attributes required to form the subscriber like IP addresses, DNS servers, and referenced configuration profiles. Some of those attributes can be changed by RADIUS dynamically using CoA requests without disconnecting the subscriber.

## RADIUS Accounting

A RADIUS **Acct-Status-Type** attribute is used by the RADIUS client (subscriber daemon) to mark the start of accounting (for example, upon booting) by specifying **Accounting-On** and to mark the end of accounting (for example, just before a scheduled reboot) by specifying **Accounting-Off**. This message is often used by RADIUS servers to automatically close/terminate all open accounting records/sessions for the corresponding client, and therefore must not be sent to servers belonging to a profile that was already used/started for accounting.

Per default, the assumption is that all servers referenced by a RADIUS profile share the same states and therefore accounting-on must be only sent to one of those before the first **accounting-start** is sent.

RADIUS **Accounting-On/Off** messages are optionally enabled in the RADIUS Profile Configuration using the **accounting-on-off** attribute. The additional attribute **accounting-on-wait** prevents any new session until accounting has started meaning that the **Accounting-On** response is received.



Currently, **Accounting-Off** is not implemented.

RADIUS accounting requests are often used for billing and therefore should be able to store and retry over a more extended period (commonly up to 24 hours or more) which can be optionally enabled in the RADIUS profile configuration using the **accounting-backup** attribute. The maximum backup accounting hold time in seconds is defined in the attribute **accounting-backup-max**.

## RADIUS Redundancy

RBFS allows configuring multiple RADIUS authentication and accounting servers for redundancy and or load-balancing. RADIUS redundancy ensures high availability in subscriber authentication, authorization, and accounting services. You can configure multiple RADIUS servers, and when one goes down, another takes over.

The following algorithms are supported:

- **DIRECT (default):** Requests are sent to the same server where the last request was sent. If the subscriber daemon receives no response from the server, requests are sent to the next server.
- **ROUND-ROBIN:** Requests are sent to servers in sequence, starting with the one following the server that handled the last request. If the subscriber

daemon router receives no response from the server, requests are sent to the next server.

## RADIUS NAS Port Identifier

RADIUS **NAS-Port-id** is used to identify the port of a network access router that the subscriber management feature uses to authenticate subscribers.

The RADIUS attribute NAS-Port-Id (87) is formatted such as the following:

```
<NAS-IDENTIFIER>#<IFP>#<OUTER-VLAN>#<INNER-VLAN>#<ACI>#<ARI>
```

The **Agent-Circuit-Id** (ACI) and **Agent-Remote-Id** (ARI) are replaced with an empty string (##) if not available.

## PPP over Ethernet (PPPoE)

PPP over Ethernet (PPPoE) is the common standard for internet access in the market.

### PPPoE Session ID

The PPPoE session ID field is an unsigned 16-bit number as described in RFC2516. The values 0 and 65535 are reserved, with 0 used for PADI/PADO messages and 65535 reserved for future use. The session ID is unique within a broadcast domain (including IFP and VLANs) and for each subscriber device's MAC address. However, it is not unique per device or application instance. The session ID will change each time the session is reconnected.

### PPPoE Service Name

When a subscriber device sends a PADI or PADR packet, the packet may include a **service name** field that specifies a particular service the client is requesting. Though, the system internally ignores the service name from the request, the name is still copied to the response packet sent back to the subscriber device.

If the request does not include any service name, the server's response (PADO or PADS) will include a default service name called **access** that ensures compatibility with certain clients, such as the Linux 'pppd'.



## PPPoE AC-Cookie

This TAG is actually used to aid in protecting against denial-of-service attacks, but it is primarily used in RBFS to decide if a received PADR is a retry for an already answered (PADS send) one. The value itself is unpredictable and generated securely but it does not protect from reply attacks.

If a client receives this TAG in PADO, it MUST return the TAG unmodified in the following PADR. The TAG\_VALUE is binary data of any value and length and is not interpreted by the Host.

The AC-Cookie is generated based on 8-bit salt followed by MD5 hash of salt, client MAC and dynamic PPPoE cookie secret.

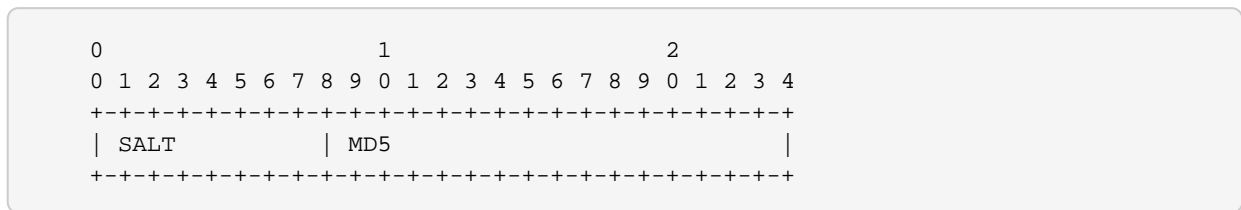

The PPPoE cookie secret is randomly generated during the PPPoE daemon startup.

The AC-Cookie in the PADR creating the session is stored in the PPPoE PPP session object. For any received PADR it can be checked if there is a session on the same broadcast domain (IFP and VLAN's) and MAC with the same AC-Cookie. In this case, the PADS is just retried.

If the broadcast domain and MAC is equal but AC-Cookie is different, this PADR must be considered as a new request.

This allows to separate two different PPPoE sessions on the same VLAN from the same MAC as frequently used by some service providers.

## PPPoE Session Limit

A customer line is typically represented by one (single-tagged) or two VLAN (double-tagged) on a physical interface with a limitation to one session, which is also called the 1:1 VLAN mode.

In some cases, the customer CPE will set up multiple PPPoE sessions on a single VLAN which requires MAC limitations greater than one but less or equal to the per VLAN limitation.

Therefore RBFS supports two different session limitations in the access interface configuration ([Access Interface Configuration](#)), one per VLAN (max-subscribers-per-vlan) and an additional per client MAC address (max-subscribers-per-mac) both set to 1 per default as required for 1:1 VLAN mode.

The limitation of sessions per client MAC address must be less or equal the sessions per VLAN and the default set to one for both limits.

## MTU Profiles

Bare metal switch hardware is typically limited in the number of supported MTU values. So RBFS has introduced the concept of MTU profiles with different types like [physical](#), [ip](#), [IPoE](#), or [pppoe](#). The last one is reserved for use with PPPoE sessions and applies to IPv4 and IPv6 traffic.

```
supervisor@switch: cfg> show config forwarding-options mtu-profile
{
  "rtbrick-config:mtu-profile": [
    {
      "mtu-profile-name": "IP-MTU-1500",
      "size": 1500,
      "type": "ip",
      "action": "redirect-to-cpu"
    },
    {
      "mtu-profile-name": "IP-MTU-9202",
      "size": 9202,
      "type": "ip",
      "action": "drop"
    },
    {
      "mtu-profile-name": "__default_pppoe__",
      "size": 1492,
      "type": "pppoe",
      "action": "redirect-to-cpu"
    }
  ]
}
```



The physical access interface should be configured with an MTU profile large enough to serve all IPoE and PPPoE MTU profiles, including the additional overhead for PPPoE and VLAN headers. Further details about interface MTU profiles can be found in the *Interfaces Configuration Guide*.

The Q2a/Q2c platform supports up to 8 MTU profiles in total including the default PPPoE profile [default\\_pppoe](#). The default profile cannot be deleted but overwritten to change size and action.

The action could be either **drop** or **redirect-to-cpu**. The action **drop** silently discards all oversized packets. The action **redirect-to-cpu** punts oversized packets to the CPU where those could be either fragmented or dropped with ICMP response.

Fragmentation in software (cpu) must be explicitly enabled:

```
supervisor@switch: cfg> show config forwarding-options fragmentation
{
  "rtbrick-config:fragmentation": {
    "ipv4": {
      "state": "cpu"
    }
  }
}
```

## MTU Profile Support for PPPeE Subscribers

The Point-to-Point Protocol (PPP) facilitates the negotiation of a Maximum Receive Unit (MRU) between endpoints, which is then applied as the Maximum Transmission Unit (MTU) on the opposite end of the PPP link. It is standard for each endpoint to independently negotiate its MRU, leading to potentially different MTU values for each direction of the PPP connection.

As an Internet Service Provider (ISP), control over the MTU/MRU sizes utilized for PPP over Ethernet (PPPoE) is not completely under your control. To address this, RBFS adopts a unique approach to managing PPPoE MTU profiles. Within RBFS, you can configure multiple PPPoE MTU profiles, however, they collectively count as a single entity against the eight MTU profile slots available on the Q2a/Q2c platform.

When a client initiates an MRU request via PPP Link Control Protocol (LCP) Configure-Request, RBFS employs this value to identify a matching MTU profile. This process involves sequentially comparing the requested MRU against an ordered list of MTU profiles until a profile with an MTU size equal to or greater than the requested MRU is located. If an exact match is found, the corresponding profile is selected, the exact match counter is incremented, and the MRU is deemed acceptable.

If no exact match exists, the system selects the closest, yet smaller, MTU profile from the list. This selection increments the best match counter, and the MTU from this profile is proposed to the client through a PPP LCP Configure-Nak message. Should the client reject the proposed MRU after three attempts, RBFS applies the

default MTU profile *default\_pppoe* as fallback MTU profile. This protocol ensures that the client's requested MRU is honored, but the transmission is governed by the largest available PPPoE MTU profile, thereby maximizing client compatibility.

For example, if a client requests an MRU of 1482 bytes but only profiles for 1472 and 1492 bytes are configured, the system will offer 1472 bytes as the best match through a PPP LCP Configure-Nak. The client may accept this offer by submitting a new PPP LCP Configure-Request for 1472 bytes or persist with the initial request of 1482 bytes. After three iterations without agreement, the fallback profile is activated, accepting the client's MRU of 1482 bytes but applying the default MTU of 1492 bytes. This approach is justified as most Customer Premises Equipment (CPE) devices support TCP Maximum Segment Size (MSS) clamping based on the negotiated MRU, ensuring that at least TCP traffic adheres to the negotiated limit. Furthermore, it is not unusual for CPEs to accept packets exceeding the negotiated MRU, which is why a larger MTU profile is designated as the fallback.

The negotiated MRU and applied MTU can be verified with the following command for every single PPPoE session.

```
user@switch: op> show pppoe session 72339069014638648 detail
Subscriber-Id: 72339069014638648
State: ESTABLISHED
...
PPP LCP:
...
MRU: 1492 Peer: 1492
MTU: 1492 Profile: __default_pppoe__
...
```

The command *show pppoe mtu-profile* lists all PPPoE MTU profiles in increasing order, with two statistics about the exact and best match.

```
supervisor@switch: op> show pppoe mtu-profile
Profile           MTU      Exact Match    Best Match
PPPoE-MTU-1320   1320     0              0
PPPoE-MTU-1456   1456     0              0
PPPoE-MTU-1472   1472     0              0
__default_pppoe__ 1492     0              0
```

The exact and best match counters can be used by operators to verify if the configured MTU profiles fit their environment or should be adopted.

As specified in RFC 2516, the Point-to-Point Protocol over Ethernet (PPPoE) requires a maximum negotiated MTU/MRU of 1492 bytes. However, RFC 4638

introduces the PPP-Max-Payload Tag, which extends the maximum negotiable MTU/MRU beyond 1492 bytes. This enhancement aims to reduce fragmentation within emerging broadband networks.

To configure an MTU/MRU exceeding 1492 bytes, a PPPoE client must incorporate the PPP-Max-Payload Tag within the PADI and PADR packets. Should the PPP-Max-Payload Tag specify a value greater than 1492 bytes, and if either the PPP LCP MRU or the MTU outlined in the access-profile is also configured above 1492, the tag will be replicated into the PADO and PADS packets issued by the RBFS. Echoing the PPP-Max-Payload Tag to the client signals support for MTU/MRU beyond 1492 bytes.

The value indicated by the PPP-Max-Payload Tag establishes the maximum threshold for both MTU and MRU settings.

Therefore, the highest permissible MTU/MRU is determined by the smaller of the two values, the configured PPP LCP MTU/MRU or the PPP-Max-Payload Tag's value.

At least one of the following values must be set to a value of more than 1492 bytes:

```
set access access-profile pppoe-dual protocol ppp lcp mru 1500
set access access-profile pppoe-dual protocol ppp lcp mtu 1500
```

It is also required to set an MTU profile with the desired MTU size:

```
set forwarding-options mtu-profile pppoe-1500
set forwarding-options mtu-profile pppoe-1500 size 1500
set forwarding-options mtu-profile pppoe-1500 type pppoe
set forwarding-options mtu-profile pppoe-1500 action redirect-to-cpu
```

For L2TPv2 tunneled PPPoE sessions, the MTU is enforced by the LNS. It's usual behavior that the LNS renegotiates the MTU. So LAC may not know the actual MTU. This is the reason why RBFS does not apply an MTU profile for such sessions.

RBFS overwrites the selected MTU profile with *default\_l2tp* for L2TPv2 sessions. This profile must be explicitly created, otherwise it is ignored. The action must be **drop** because ICMP or fragmentation is not supported for tunneled sessions.

```
supervisor@switch: cfg> show config forwarding-options mtu-profile
__default_l2tp__
{
  "rtbrick-config:mtu-profile": [
    {
```

```
    "mtu-profile-name": "__default_l2tp__",
    "size": 1492,
    "type": "pppoe",
    "action": "drop"
  }
]
```

This configuration allows to optionally enforce an MTU on LAC if needed.

Following an example MTU profile configuration for PPPoE supporting all MTU values between the minimum of 1280 and maximum of 1500 in steps of 8 bytes.

```
supervisor@switch: cfg> show config forwarding-options mtu-profile
{
  "rtbrick-config:mtu-profile": [
    {
      "mtu-profile-name": "__default_pppoe__",
      "size": 1492,
      "type": "pppoe",
      "action": "redirect-to-cpu"
    },
    {
      "mtu-profile-name": "PPPoE-MTU-1280",
      "size": 1280,
      "type": "pppoe",
      "action": "redirect-to-cpu"
    },
    {
      "mtu-profile-name": "PPPoE-MTU-1288",
      "size": 1288,
      "type": "pppoe",
      "action": "redirect-to-cpu"
    },
    {
      "mtu-profile-name": "PPPoE-MTU-1296",
      "size": 1296,
      "type": "pppoe",
      "action": "redirect-to-cpu"
    },
    {
      "mtu-profile-name": "PPPoE-MTU-1304",
      "size": 1304,
      "type": "pppoe",
      "action": "redirect-to-cpu"
    },
    {
      "mtu-profile-name": "PPPoE-MTU-1312",
      "size": 1312,
      "type": "pppoe",
      "action": "redirect-to-cpu"
    },
    {
      "mtu-profile-name": "PPPoE-MTU-1320",
      "size": 1320,
      "type": "pppoe",
      "action": "redirect-to-cpu"
    }
  ]
}
```

```
},
{
  "mtu-profile-name": "PPPoE-MTU-1328",
  "size": 1328,
  "type": "pppoe",
  "action": "redirect-to-cpu"
},
{
  "mtu-profile-name": "PPPoE-MTU-1336",
  "size": 1336,
  "type": "pppoe",
  "action": "redirect-to-cpu"
},
{
  "mtu-profile-name": "PPPoE-MTU-1344",
  "size": 1344,
  "type": "pppoe",
  "action": "redirect-to-cpu"
},
{
  "mtu-profile-name": "PPPoE-MTU-1352",
  "size": 1352,
  "type": "pppoe",
  "action": "redirect-to-cpu"
},
{
  "mtu-profile-name": "PPPoE-MTU-1360",
  "size": 1360,
  "type": "pppoe",
  "action": "redirect-to-cpu"
},
{
  "mtu-profile-name": "PPPoE-MTU-1368",
  "size": 1368,
  "type": "pppoe",
  "action": "redirect-to-cpu"
},
{
  "mtu-profile-name": "PPPoE-MTU-1376",
  "size": 1376,
  "type": "pppoe",
  "action": "redirect-to-cpu"
},
{
  "mtu-profile-name": "PPPoE-MTU-1384",
  "size": 1384,
  "type": "pppoe",
  "action": "redirect-to-cpu"
},
{
  "mtu-profile-name": "PPPoE-MTU-1392",
  "size": 1392,
  "type": "pppoe",
  "action": "redirect-to-cpu"
},
{
  "mtu-profile-name": "PPPoE-MTU-1400",
  "size": 1400,
  "type": "pppoe",
  "action": "redirect-to-cpu"
},
},
```

```
{
  "mtu-profile-name": "PPPoE-MTU-1408",
  "size": 1408,
  "type": "pppoe",
  "action": "redirect-to-cpu"
},
{
  "mtu-profile-name": "PPPoE-MTU-1416",
  "size": 1416,
  "type": "pppoe",
  "action": "redirect-to-cpu"
},
{
  "mtu-profile-name": "PPPoE-MTU-1424",
  "size": 1424,
  "type": "pppoe",
  "action": "redirect-to-cpu"
},
{
  "mtu-profile-name": "PPPoE-MTU-1432",
  "size": 1432,
  "type": "pppoe",
  "action": "redirect-to-cpu"
},
{
  "mtu-profile-name": "PPPoE-MTU-1440",
  "size": 1440,
  "type": "pppoe",
  "action": "redirect-to-cpu"
},
{
  "mtu-profile-name": "PPPoE-MTU-1448",
  "size": 1448,
  "type": "pppoe",
  "action": "redirect-to-cpu"
},
{
  "mtu-profile-name": "PPPoE-MTU-1456",
  "size": 1456,
  "type": "pppoe",
  "action": "redirect-to-cpu"
},
{
  "mtu-profile-name": "PPPoE-MTU-1464",
  "size": 1464,
  "type": "pppoe",
  "action": "redirect-to-cpu"
},
{
  "mtu-profile-name": "PPPoE-MTU-1472",
  "size": 1472,
  "type": "pppoe",
  "action": "redirect-to-cpu"
},
{
  "mtu-profile-name": "PPPoE-MTU-1480",
  "size": 1480,
  "type": "pppoe",
  "action": "redirect-to-cpu"
},
{
```



```

    "mtu-profile-name": "PPPoE-MTU-1488",
    "size": 1488,
    "type": "pppoe",
    "action": "redirect-to-cpu"
  },
  {
    "mtu-profile-name": "PPPoE-MTU-1490",
    "size": 1490,
    "type": "pppoe",
    "action": "redirect-to-cpu"
  },
  {
    "mtu-profile-name": "PPPoE-MTU-1500",
    "size": 1500,
    "type": "pppoe",
    "action": "redirect-to-cpu"
  }
]
}

```

## MTU Profile Support for IPoE Subscribers

Unlike the PPPoE protocol, which can negotiate MTU dynamically, IPoE relies on a fixed MTU setting. The MTU value is predefined and remains constant for all IPoE subscribers using the configured access interface.

For IPoE subscribers, MTU is statically configured and is applied at the access interface level.

Configuration commands for the MTU profile for IPoE subscribers.

```

set access access-profile ipoe
set access access-profile ipoe instance default
set access access-profile ipoe protocol dhcp enable true
set access access-profile ipoe protocol dhcp lease-time 3600
set access access-profile ipoe protocol dhcpv6 enable true
set access access-profile ipoe protocol dhcpv6 lifetime 3600
set access access-profile ipoe protocol ipoe ip-mtu-profile ipoe_mtu_1500

```

It is also required to set an MTU profile with the desired MTU size:

```

set forwarding-options mtu-profile ipoe_mtu_1500
set forwarding-options mtu-profile ipoe_mtu_1500 size 1500
set forwarding-options mtu-profile ipoe_mtu_1500 type ip
set forwarding-options mtu-profile ipoe_mtu_1500 action drop

```

Following is an example of access profile IPoE:

```

supervisor@rtbrick.net: cfg> show config access access-profile ipoe

```

```

{
  "rtbrick-config:access-profile": [
    {
      "profile-name": "ipoe",
      "instance": "default",
      "protocol": {
        "dhcp": {
          "enable": "true",
          "lease-time": 3600
        },
        "dhcpv6": {
          "enable": "true",
          "lifetime": 3600
        },
        "ipoe": {
          "ip-mtu-profile": "ipoe_mtu_1500"
        }
      },
      "address-family": {
        "ipv4": {
          "enable": "true",
          "pool-name": "poolv4"
        },
        "ipv6": {
          "enable": "true",
          "pool-name": "poolv6",
          "prefix-delegation-pool-name": "poolv6pd"
        }
      }
    }
  ]
}

```

Following an example MTU profile configuration for IPoE:

```

supervisor@DT-STD-23-2401>bm13-tst.fsn.rtbrick.net: cfg> show config forwarding-
options mtu-profile
{
  "rtbrick-config:mtu-profile": [
    {
      "mtu-profile-name": "ipoe_mtu_1500",
      "size": 1500,
      "type": "ip",
      "action": "drop"
    }
  ]
}

```

## PPPoE VLAN Profiles

This chapter describes the VLAN profile feature. If enabled for the access interface, then incoming sessions (e.g. PPPoE PADI/PADR) are not honored unless matching vlan-profile is found.

The VLAN profiles must be added to the table `global.vlan.profile` owned by PPPoE daemon. All entries in this table are ephemeral and therefore lost after reboot or PPPoE daemon restart.

**Example:**

```
{
  "table": {
    "table_name": "global.vlan.profile"
  },
  "objects": [
    {
      "attribute": {
        "ifp_name": "ifp-0/1/2",
        "outer_vlan_min": 128,
        "outer_vlan_max": 128,
        "inner_vlan_min": 1,
        "inner_vlan_max": 4095,
        "access_profile_name": "access-profile-vlan"
      }
    }
  ]
}
```

**PPPoE Dual-Stack IPv4/IPv6 with DHCPv6**

The whole IPv6 control plane of a PPPoE session like ICMPv6 router-solicitation (RS), ICMPv6 router-advertisement (RA) and DHCPv6 is handled in the PPPoE daemon (pppoed).

The PPPoE daemon handles received router solicitations by responding with router advertisements and is sending frequent router advertisements based on configured intervals.

The other-config flag in the router-advertisement is automatically set if DHCPv6 is enabled for this particular subscriber. This flag signals that there is more information available via DHCPv6.

DHCPv6 over PPPoE is different to DHCPv6 over Ethernet because of the special characteristics of point-to-point protocols. DHCPv6 over PPPoE is supporting delegated IPv6 prefixes (IA\_PD) and DNS options only. Unsupported IA options (IA\_NA and IA\_TA) or options that can be served will be rejected with status code options as defined per RFC.

The delegated IPv6 prefix served by DHCPv6 will be assigned to the subscriber via RADIUS or local pool regardless of the protocols negotiated with the client.

DHCPv6 was primarily designed for use in Ethernet networks. The fact that Ethernet is connectionless requires that DHCPv6 servers must manage releases for the clients and free them automatically if a lease expires. Such extensive release management is not needed for connection-oriented protocols like PPPoE where addresses are assigned to the PPPoE session. This fact allows to implementing DHCPv6 nearly stateless on the server side by just tracking if an assigned prefix is assigned or released. This is tracked in the attribute `ipv6pd_negotiated` of the PPPoED/SubscriberD (`global.ppp.1.subscriber.result`) result object and copied to the actual subscriber object (`local.access.subscriber`). As this use case is covered by PPPoE, there is no lease expiry implemented.

The delegated-prefix is added to the subscriber-ifl only if negotiated and removed if not negotiated. The presence of delegated prefix in the subscriber-ifl is used by IFMD to add or remove the forwarding entry.

If DHCPv6 is enabled but no delegated prefix provided, only DNS is served in response if available.

### PPPoE DHCPv6 Server DUID

The DHCPv6 server identifier DUID is generated based on IP6CP negotiated interface-identifier as shown below:

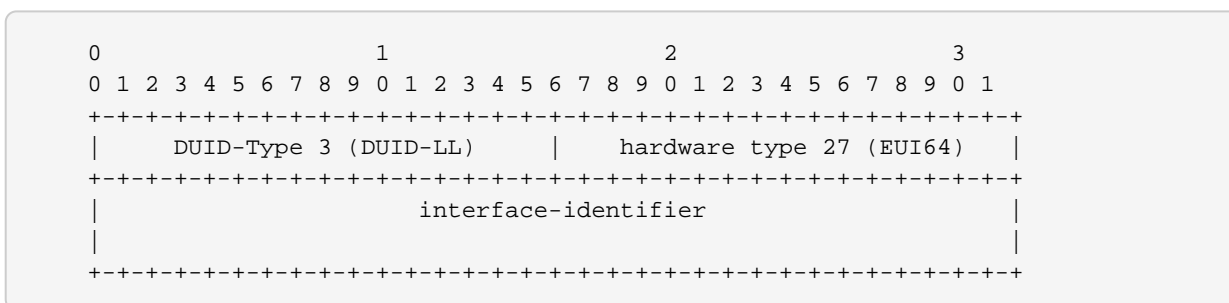

### Layer Two Tunneling Protocol (L2TPv2)

This chapter describes the RtBrick Layer Two Tunneling Protocol (L2TPv2) implementation. This document describes also the corresponding configuration and operations commands for PPPoE access services with PPP tunneling using the Layer Two Tunneling Protocol version 2 (L2TPv2) on RtBrick FullStack (RBFS).

Typically, a user obtains a Layer 2 (L2) point-to-point connection to a Broadband Network Gateway (BNG) using the PPPoE protocol as described in RFC 2516 and runs PPP over that connection. In the most common case, the L2 termination point

and PPP session endpoint reside on the same physical device. Tunneling protocols, such as L2TPv2 provide a dynamic mechanism for extending PPP by allowing the L2 and PPP endpoints reside on different devices that are interconnected by an IP network. This separation allows the actual processing of PPP packets to be divorced from the termination of the L2 circuit. The L2TP access concentrator (LAC) physically terminates the L2 connection and tunnels the PPP packets across an IP network to the L2TP network server (LNS). The LNS then terminates the logical PPP connection.



RFC and draft compliance are partial except as specified.

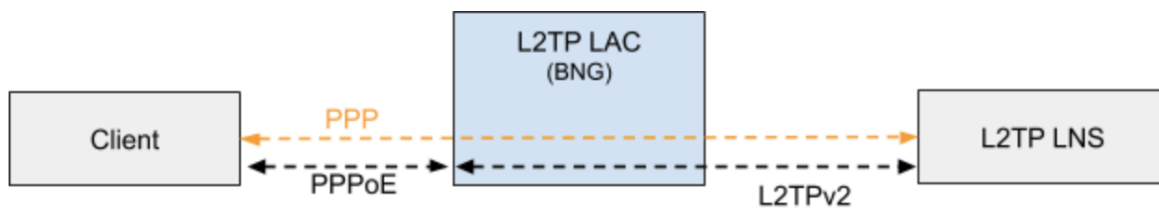

Figure 3. L2TP PPPoE

To establish a PPPoE session via L2TP, the tunnel-type must be configured as L2TP. This configuration can be achieved either for local users or by utilizing the corresponding tunnel-type attribute through RADIUS.

```

# Local User
cfg> set access user-profile local@l2tp tunnel-type L2TP

# FreeRADIUS
"radius@l2tp" Cleartext-Password := "test"
  Service-Type = Framed-User,
  Framed-Protocol = PPP,
  Tunnel-Type:0 = L2TP
  
```

Defining an L2TP configuration profile is essential, which can be referenced through an access-profile or by employing the appropriate RADIUS VSA. The actual tunnels may either be defined locally via an L2TP pool configuration or set up dynamically through RADIUS.



Currently, RBFS supports L2TP subscriber sessions with EtherType 0x8100 (802.1Q) only; it does not support EtherType 0x88a8 (802.1ad).

## L2TP LAC

The L2TP Access Concentrator (LAC) is a node that acts as one side of an L2TP tunnel endpoint, and is a peer to the L2TP Network Server L2TP LNS. The LAC sits between a LNS and a remote system, and forwards packets to and from each.

## L2TP LNS

The L2TP Network Server (LNS) is a node that acts as one side of an L2TP tunnel endpoint and is a peer to the L2TP Access Concentrator L2TP LAC. The LNS is the logical termination point of a PPP session that is being tunneled from the remote system by the LAC.



| The LNS role is currently not supported!

## L2TP Tunnel Selection

Each new session creates a session request object (`local.l2tp.session.request`) to track the tunnel selection progress, the currently selected ones, and which are already tried. This object is automatically deleted if the session setup is successful.

All tunnels in state DEAD are skipped in the tunnel selection but considered at the end if no other tunnels are available. Tunnels with a session limit reached are not considered for further sessions. To select a tunnel, the L2TP daemon first generates list of preferred tunnels based on tunnel preference, where the lowest value has the highest priority. The configured L2TP tunnel selection algorithm decides how to select a tunnel out of the remaining tunnels with the same preference. The RANDOM algorithm selects the tunnel randomly whereas BALANCED selects the least filled tunnel based on the number of sessions.

Following the L2TP tunnel pool order/priority in case, there are multiple pools available for a single subscriber:

1. RADIUS defined tunnel (RFC2866)
2. RADIUS VSA (RtBrick-L2TP-Pool) or local user profile
3. L2TP configuration profile

## L2TP Control Channel

The control channel is responsible for the orderly passing of control messages between the tunnel endpoints and acts as a transport layer for reliable delivery of

control messages and tunnel keep alive services for the tunnel.

Each L2TP tunnel is split into the actual tunnel object with all the information exchanged during tunnel establishment plus the FSM state and a separate control channel with the sequence numbers, window size, and thresholds changed with every sent and received packet.

RBFS sent a ZLB ACK only if there are no further messages waiting in queue for that peer, as well as to acknowledge multiple packets at once.

The HELLO keep-alive messages are also part of the control channel and only send if there is no other message sent if the queue is empty and no other message send during the hello interval.

## L2TP Access Line Information (RFC5515)

### Connect-Speed-Update-Notification (CSUN)

The Connect-Speed-Update-Notification (CSUN) is an L2TP control message sent by the LAC to the LNS to provide transmit and receive connection speed updates for one or more sessions.



This implementation will send one CSUN request per session!

CSUN requests are disabled per default and can be enabled in the L2TP profile [L2TP Profile Configuration](#).

CSUN messages are defined in RFC5515, which is not widely supported. Therefore those messages are marked as not mandatory in RBFS to allow interwork with LNS servers not supporting RFC5515.

### RFC2661:

The Mandatory (M) bit within the Message Type AVP has special meaning. Rather than an indication of whether the AVP itself should be ignored if not recognized, it is an indication as to whether the control message itself should be ignored. Thus, if the M-bit is set within the Message Type AVP and the Message Type is unknown to the implementation, the tunnel **MUST** be cleared. If the M-bit is not set, then the implementation may ignore an unknown message type.



RFC and draft compliance are partial except as specified.

## Connect-Speed-Update-Request (CSURQ)

The Connect-Speed-Update-Request (CSURQ) is an L2TP control message sent by the LNS to the LAC to request the current transmission and receive connection speed for one or more sessions.



Sending or responding to CSURQ requests is currently not supported!

## Access Line Information L2TP Attribute Value Pair Extensions

The corresponding access line information for a subscriber is included in the ICRQ message as defined in RFC5515.

## Connect Speed Values

The default value for TX and RX Connect Speed is set to 1000000000 (1G) which is replaced by the actual data rate upstream/downstream of the corresponding access line information object or directly set using the RADIUS attributes RtBrick-L2TP-Tx-Connect-Speed (42) and RtBrick-L2TP-Rx-Connect-Speed (43).

## IPoE

IP-over-Ethernet (IPoE) is a popular alternative to PPPoE based access using DHCP for IPv4 and DHCPv6 for IPv6 where both protocols are handled in the IPoE daemon (ipoe).

IPoE subscribers are identified by IFP, optional VLAN and client MAC address.

The dynamic creation of IPoE subscribers is triggered by the first DHCPv4 discovery or DHCPv6 solicit request received. Any response is postponed until the subscriber is successfully authenticated using known authentication methods like none, local or RADIUS. For DHCP mode **server** all addresses are assigned during authentication to the subscriber and used by DHCPv4 and DHCPv6 to handle client requests. For the DHCP relay mode, all IP addresses are allocated by an external DHCP server.

IPoE subscribers will be terminated automatically if all protocol bindings are deleted.



## IPoE 1:1 VLAN Support

RBFS supports both 1:1 VLAN (VLAN Per Subscriber) model for subscriber traffic for IPoE subscribers.

### 1:1 VLAN (VLAN-per-subscriber) Model

In the 1:1 VLAN model, there is a unique dedicated customer VLAN for a subscriber, that is one VLAN per Subscriber. This model establishes a unique path between each subscriber interface and the router for data transmission by providing traffic separation for every subscriber.

1:1 model operations are relatively simple as it provides one-to-one mapping of specific VLANs to specific subscribers. New services can be added easily without affecting other subscribers and services with this model. However, in a large-scale deployment, this model demands highly scalable and robust routers that can manage many hundreds of VLANs.

The following diagram shows a dedicated customer VLAN for a subscriber, that is, one VLAN per Subscriber.

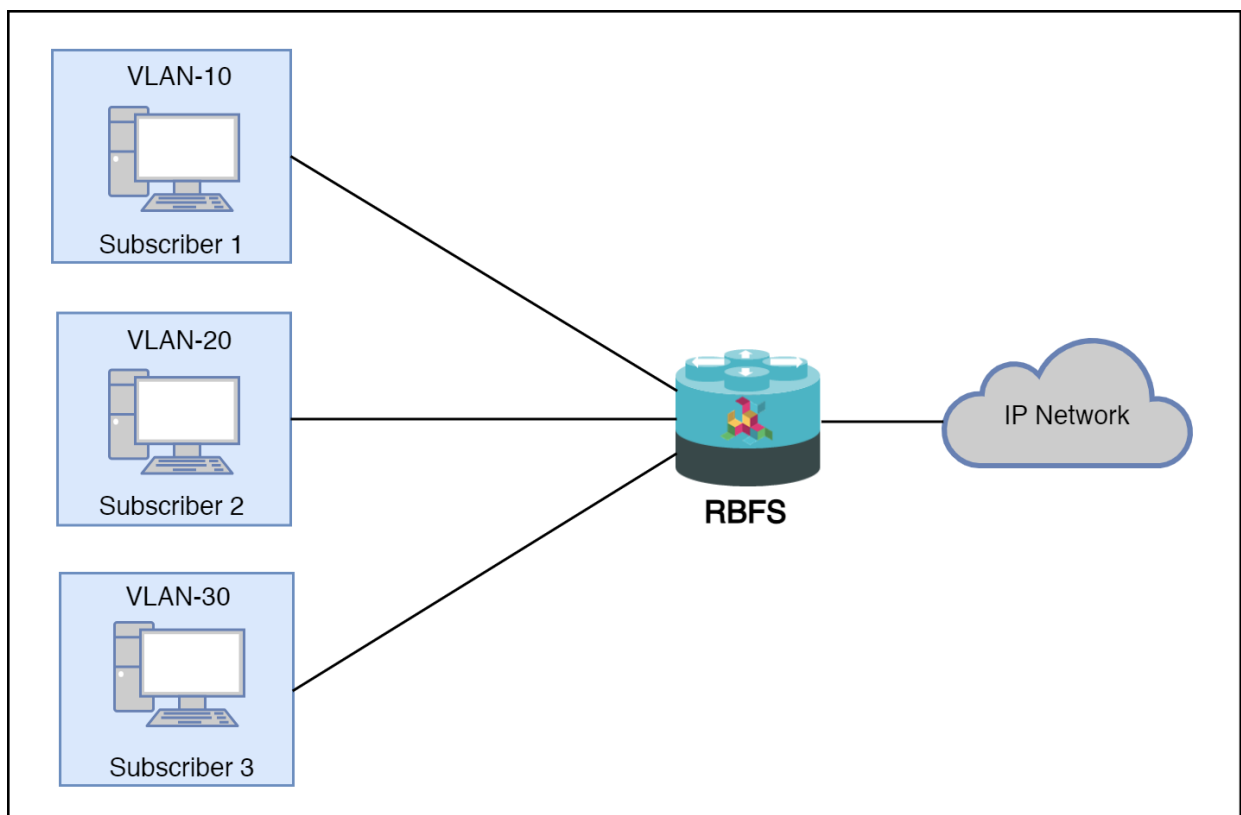

Figure 4. 1:1 VLAN (VLAN-per-subscriber)

## N:1 VLAN (Shared VLAN) Model

The Shared VLAN model provides many-to-one (N:1) subscriber-to-service connectivity. This model provides a single VLAN to many subscribers. Unlike in the 1:1 model, in which the VLAN is dedicated to a customer, N:1 provides a shared VLAN to many subscribers, and this VLAN carries all types of service (i.e., data, voice, video, etc.). One disadvantage of shared VLAN is the lack of logical isolation between user sessions at the VLAN level.

The following diagram shows a single VLAN that is connected to many subscribers.

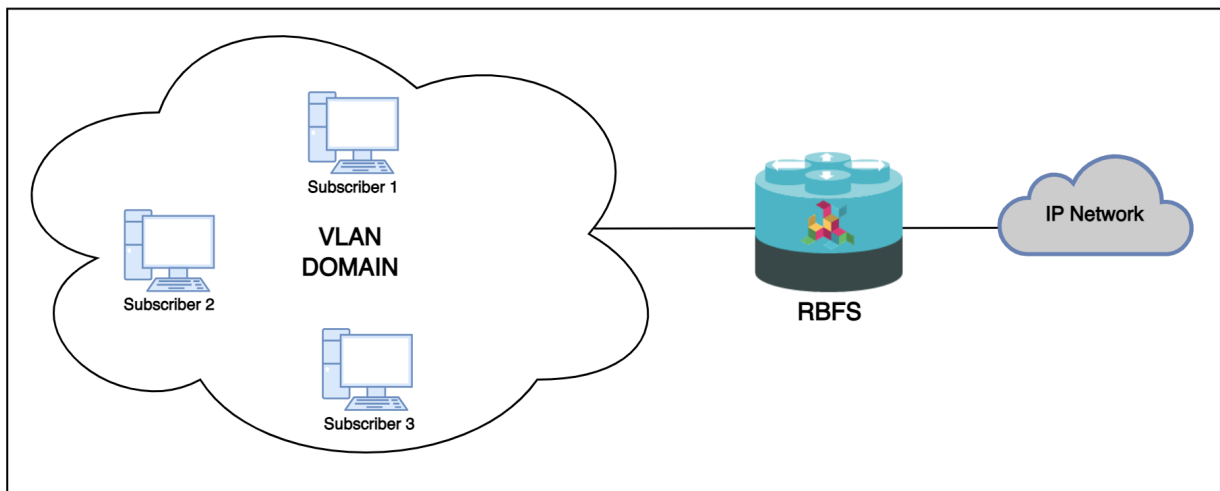

Figure 5. N:1 VLAN (Shared VLAN-per-service)

### Limitations for I PoE N:1 VLAN

Access services such as http-redirect, subscriber-acl, NAT, IGMP are not supported for I PoE N:1 subscribers.

### I PoE Session Limit

A customer line is typically represented by one (single-tagged) or two VLAN (double-tagged) on a physical interface with a limitation to one subscriber, which is also called the 1:1 VLAN mode.

I PoE subscribers are implicitly limited to max one per MAC address, as client MAC address is used as part of the key to identify subscribers.

### I PoE Username

For each I PoE subscriber, a username is generated automatically using the client's MAC address followed by @ipoe.

Example: `fe:08:e8:ea:1d:32@ipoe`

### IPoE DHCPv6 Server DUID

The generated DHCPv6 server identifier DUID is from type 3 (DUID-LL) with hardware type 27 (EUI64) and IFP MAC address to derive the EUI64 interface identifier.

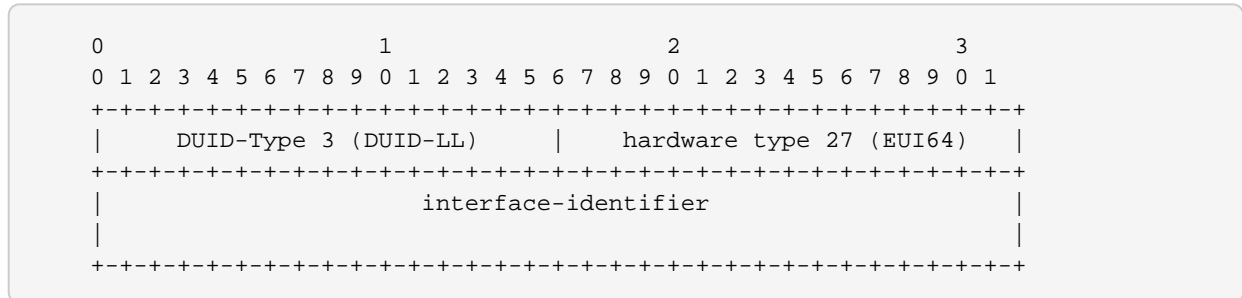

### IPoE DHCP Relay

When IPoE is configured on relay mode, the system relies on an external DHCP server for IP address allocation and client configuration functions. The DHCP server contains a pool of IP addresses, and from that pool, it allocates addresses to subscribers. RBFS acts as a DHCP relay during its interaction with the DHCP server. The feature allows multiple RBFS instances to use a single centralized DHCP server for their IP allocation.

For information on how to configure IPoE in relay mode, see the section [DHCPv4](#).

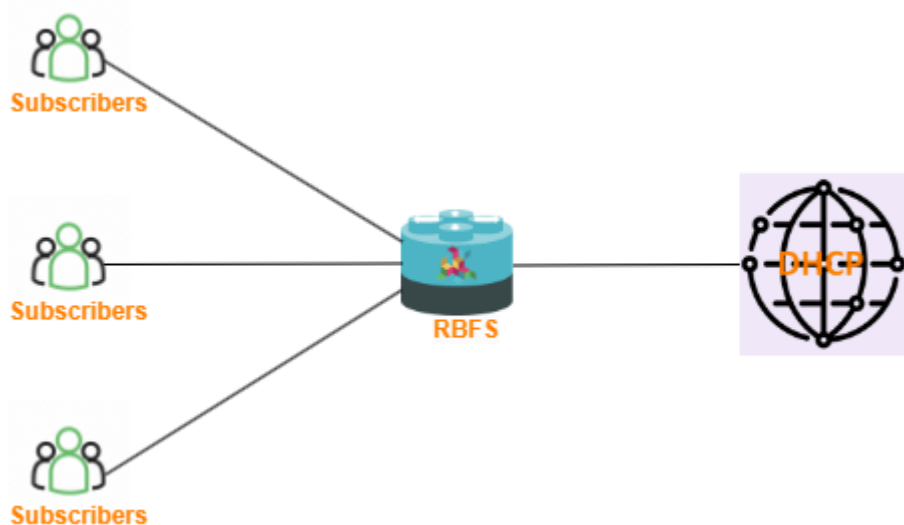

## 5.1.2. Subscriber Management Configuration Overview

RBFS Subscriber Management configuration involves setting up various profiles and parameters that control how subscribers interact with network services. This includes authentication, service access, protocol handling, and other functions organized under a structured configuration hierarchy. The profiles determine how subscribers authenticate, access network services, and use various protocols. The configuration starts with mandatory settings such as interface, access, and AAA profiles, followed by optional configurations for more features such as RADIUS, L2TP, and service profiles. Each profile plays a crucial role in ensuring efficient and secure subscriber management.

### Configuration Hierarchy

The configuration of physical interfaces (IFP) and their associated VLANs is managed through a set of profiles that define parameters for various functions. These include authentication settings with AAA, service management for protocols such as IGMP and MLD, and access protocols such as PPPoE.

The following image illustrates how the subscriber management configuration and profile system are organized.

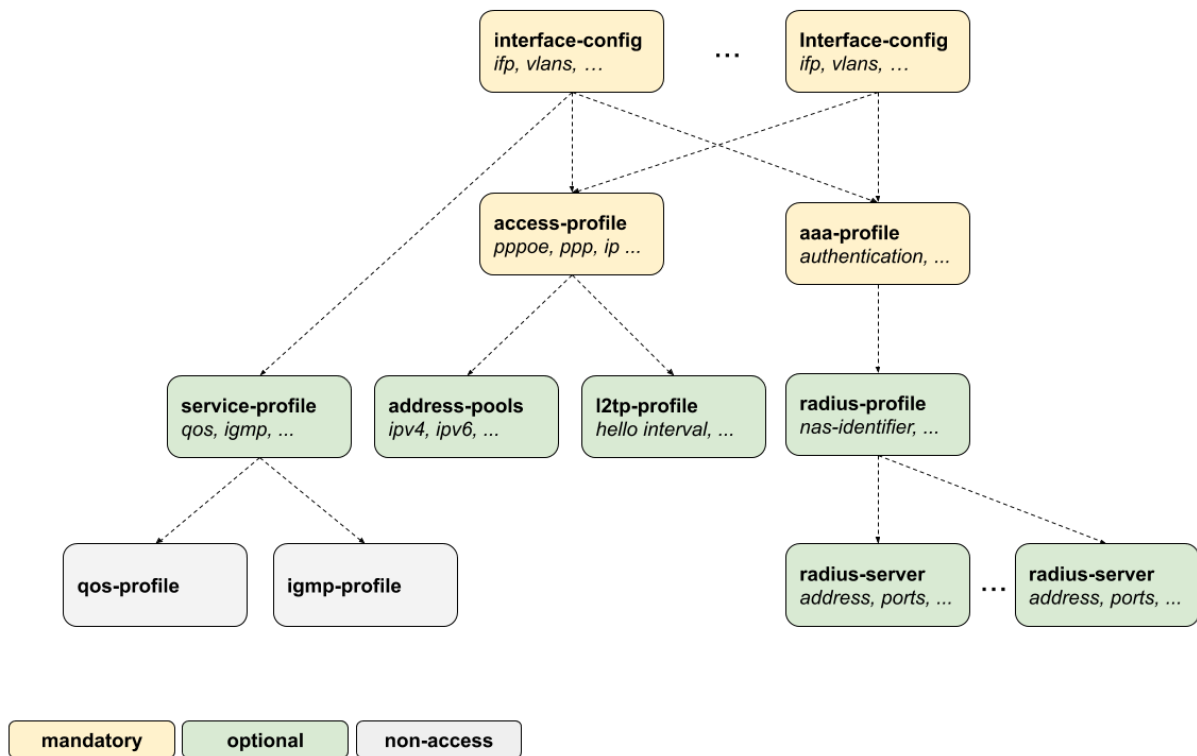

Figure 6. Configuration and Profiles

All subscriber management configurations and profiles are managed under the top-level hierarchy **access**. This hierarchy acts as the central point for defining and managing various access protocols, subscriber management profiles, and authentication settings that are crucial for network operations.

The following is the **access** command and all the high-level options available for Subscriber Management configurations.

```
supervisor@switch: cfg> set access
<cr>
aaa-profile           Global AAA profile configuration
access-profile        Global access profile configuration
chassis-id            Chassis ID for this node <0-15>
dhcp-relay            Global DHCP relay configuration
dhcp-server           Global DHCP server configuration
dhcpv6-server         Global DHCP server configuration
interface             Global interface profile configuration
l2bsa                 Global access l2bsa configurations
l2tp-pool             Global L2TPv2 pool configuration
l2tp-profile          Global L2TPv2 profile configuration
pool                  Global address pool configuration
radius-profile        Global AAA RADIUS profile configuration
radius-server         Global RADIUS server configuration
service-profile       Global service profile configuration
user-profile          Global user profile configuration
```

In the following sections, you will find comprehensive descriptions and steps for each configuration. The process begins with setting up the access interface configuration, which is the first step. This is then followed by other important access profile and AAA profile configurations, which are crucial for managing subscriber access.

- **interface-config** [Access Interface Configuration](#)
- **access-profile** [Access Profile Configuration](#)
- **aaa-profile** [AAA Profile Configuration](#)

The second part covers the optional configurations:

- **radius-profile** [RADIUS Profile Configuration](#)
- **radius-server** [RADIUS Server Configuration](#)
- **service-profile** [Service Profile Configuration](#)
- **l2tp-profile** [L2TP Profile Configuration](#)
- **address-pools** [Address Pool Configuration](#)

The **user-profile** and **l2tp-pool** are the only components not referenced by name. The key here is the user or pool name.

- **user-profile** [User Profile Configuration](#)
- **l2tp-pool** [L2TP Tunnel Pool Configuration](#)

## Access Interface Configuration

**Table:** [global.access.interface.config](#)

While there is no single specific way to configure subscriber management, it is ideal to start with mandatory configurations and then move on to optional ones. The access interface configuration is the anchor point for almost all further access configurations. The interface configuration defines the access type and access profile. For more information, see sections [Access Profile Configuration](#), [AAA profile AAA Profile Configuration](#).



Multiple interface configurations per IFP with disjoint VLAN ranges are supported.

The following image illustrates the access interface configurations and how they are associated with the entire subscriber management.

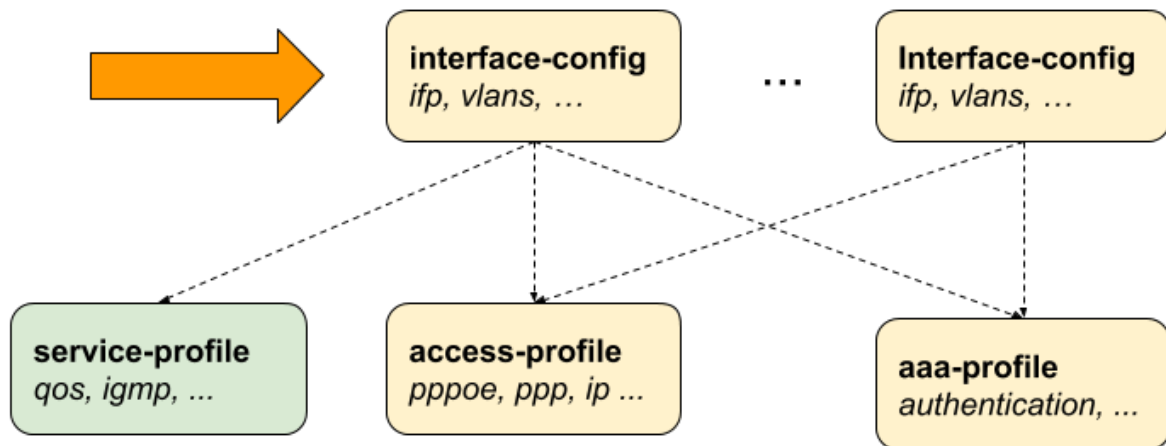

Figure 7. Access Interface Configuration

You can configure multiple interfaces for access and subscriber management, and each interface can reference the same profiles. This allows for efficient and scalable network management.

To configure the access interface, you must complete the following major tasks.

1. Configure the physical interface name (IFP or LAG) and VLAN range
2. Configure the mandatory access type (PPPoE or IPoE)
3. Configure the mandatory access profile
4. Configure the mandatory AAA profile
5. Configure optional attributes such as service profile or session limit

## Configuring Access Interfaces

Access interfaces can be configured without VLAN tags (untagged VLAN) and with one VLAN tag (single-tagged) or with two VLAN tags (double-tagged).

The following are the command and command options available to configure Access Interface.

```

supervisor@switch: cfg> set access interface
  <cr>
  double-tagged           Double tagged access
  single-tagged           Single tagged access
  untagged                Untagged access

supervisor@switch: cfg> set access interface untagged ifp-0/0/0
  <cr>
  aaa-profile-name        AAA profile name
  access-profile-name     Access profile name
  access-type             Access service type
  gateway-ifl             IPoE gateway IFL (unnumbered source IFL)
  max-subscribers-per-mac Restrict maximum subscribers per MAC address
  max-subscribers-per-vlan Restrict maximum subscribers per VLAN
  pppoe-pado-delay        Optional PPPoE PADO delay in seconds <1-255>
  redundancy-session-id   Redundancy session id for this interface <1-
4294967295>
  service-profile-name    Service profile name
  vlan-profile-enable     Enable VLAN profiles

```

### Example:

In the following example configuration, the untagged access interface 'ifp-0/0/0' is configured for PPPoE access type, with the Access Profile set to 'pppoe-dual', Service Profile set to 'service-profile1', and AAA Profile set to 'aaa-radius'. The option 'vlan-profile-enable' is enabled by setting it to 'true', and the parameters 'max-subscribers-per-vlan' and 'max-subscribers-per-mac' are both assigned the value of '1'.

```

supervisor@switch: cfg> show config access interface untagged ifp-0/0/0
{

```

```

"rtbrick-config:untagged": {
  "interface-name": "ifp-0/0/0",
  "access-type": "PPPoE",
  "access-profile-name": "pppoe-dual",
  "service-profile-name": "service-profile1",
  "aaa-profile-name": "aaa-radius",
  "vlan-profile-enable": "true",
  "max-subscribers-per-vlan": 1,
  "max-subscribers-per-mac": 1
}
}

```

Attribute	Description
access-type	<p>Defines the access protocol used for this interface. This is a mandatory attribute.</p> <p><b>Values:</b> PPPoE or IPoE</p>
access-profile-name	<p>Specifies the name of the access profile (mandatory). For more information, see <a href="#">Access Profile Configuration</a>.</p>
aaa-profile-name	<p>Specifies the name of the AAA profile (mandatory). For more information, see <a href="#">AAA Profile Configuration</a>.</p>
service-profile-name	<p>This option allows assigning an optional service profile which can be dynamically overwritten via RADIUS. For more information, see <a href="#">Service Profile Configuration</a>.</p>
max-subscribers-per-vlan	<p>This option defines the maximum number of subscribers per IFP and VLAN. A value of '1' will implicitly set the VLAN mode to 1:1 VLAN mode, where any value greater than 1 indicates N:1 VLAN mode.</p> <p><b>Default:</b> 1 <b>Range:</b> 1 - 65535</p>
max-subscribers-per-mac	<p>Maximum number of subscribers per IFP, VLAN, and MAC. This option must be less or equal specified for the 'max-subscribers-per-vlan' attribute.</p> <p><b>Default:</b> 1 <b>Range:</b> 1 - 65535</p>
vlan-profile-enable	<p>If enabled, incoming PPPoE sessions (PPPoE PADI/PADR) are not honored unless matching vlan-profile is found in the table <a href="#">global.vlan.profile</a> of the PPPoE daemon. For more information about VLAN profiles, see <a href="#">PPPoE VLAN Profiles</a>.</p> <p><b>Default:</b> false</p>



Attribute	Description
gateway-ifl	This options selects the IPoE gateway IFL (unnumbered source IFL) which is typically a loopback interface used as a gateway for IPoE subscribers.
pppoe-pado-delay	<p>(Optional) Specifies the PPPoE PADO delay, in seconds. This setting allows you to specify a wait time in seconds after receiving a PPPoE Active Discovery Initiation (PADI) control packet from a PPPoE client before sending a PPPoE Active Discovery Offer (PADO) packet to indicate that it can serve the client request. <b>Range:</b> 1 - 255</p> <div style="display: flex; align-items: center;">  <div> <p>The PPPoE PADO delay is used for stateless high availability.</p> </div> </div>

## Configuring Untagged Interfaces

The following command and options are used to configure the untagged access interface.

```

supervisor@switch: cfg> set access interface untagged
  <interface-name>      Name of the physical interface

supervisor@switch: cfg> set access interface untagged ifp-0/0/0
<cr>
  aaa-profile-name      AAA profile name
  access-profile-name   Access profile name
  access-type           Access service type
  max-subscribers-per-mac Restrict maximum subscribers per MAC address
  max-subscribers-per-vlan Restrict maximum subscribers per VLAN
  pppoe-pado-delay      Optional PPPoE PADO delay in seconds <1-255>
  service-profile-name  Service profile name
  vlan-profile-enable   Enable VLAN profiles

supervisor@switch: cfg> set access interface untagged ifp-0/0/0 access-type PPPoE
supervisor@switch: cfg> set access interface untagged ifp-0/0/0 access-profile-
name pppoe-dual
supervisor@switch: cfg> set access interface untagged ifp-0/0/0 aaa-profile-name
aaa-radius
supervisor@switch: cfg> commit
supervisor@switch: cfg> show config access interface untagged ifp-0/0/0
{
  "rtbrick-config:untagged": {
    "interface-name": "ifp-0/0/0",
    "access-type": "PPPoE",
    "access-profile-name": "pppoe-dual",
    "aaa-profile-name": "aaa-radius"
  }
}

```



- Untagged interfaces are not supported on Broadcom QAX platforms.
- The access **interface-name** can be a physical IFP or lag.

## Configuring Single VLAN Tagged Interfaces

You need to define the VLAN identifier range within the range from 128 to 4000 for VLAN tagged interface. The following command and options are used to configure a single VLAN-tagged interface.

```

supervisor@switch: cfg> set access interface single-tagged
  <interface-name>      Name of the physical interface

supervisor@switch: cfg> set access interface single-tagged ifp-0/0/0
  <outer-vlan-min>      Outer VLAN min

supervisor@switch: cfg> set access interface single-tagged ifp-0/0/0 128
  <outer-vlan-max>      Outer VLAN max

supervisor@switch: cfg> set access interface single-tagged ifp-0/0/0 128 3000
  <cr>
  aaa-profile-name      AAA profile name
  access-profile-name   Access profile name
  access-type           Access service type
  max-subscribers-per-mac Restrict maximum subscribers per MAC address
  max-subscribers-per-vlan Restrict maximum subscribers per VLAN
  pppoe-pado-delay      Optional PPPoE PADO delay in seconds <1-255>
  service-profile-name  Service profile name
  vlan-profile-enable    Enable VLAN profiles

```

In the following example, the single tagged access interface ifp-0/0/0 is configured with the Outer VLAN minimum value **128** and the outer VLAN maximum value **3000**. The Access Type is defined PPPoE, Access Profile **pppoe-dual**, and AAA Profile as **aaa-radius**.

```

supervisor@switch: cfg> set access interface single-tagged ifp-0/0/0 128 3000
access-type PPPoE
supervisor@switch: cfg> set access interface single-tagged ifp-0/0/0 128 3000
access-profile-name pppoe-dual
supervisor@switch: cfg> set access interface single-tagged ifp-0/0/0 128 3000 aaa-
profile-name aaa-radius
supervisor@switch: cfg> commit
supervisor@switch: cfg> show config access interface single-tagged ifp-0/0/0 128
3000
{
  "rtbrick-config:single-tagged": [
    {
      "interface-name": "ifp-0/0/0",
      "outer-vlan-min": 128,
      "outer-vlan-max": 3000,
      "access-type": "PPPoE",

```

```

    "access-profile-name": "pppoe-dual",
    "aaa-profile-name": "aaa-radius"
  }
]
}

```



The access **interface-name** can be a physical IFP or LAG.

## Configuring Double Tagged VLAN Interfaces

When configuring double-tagged VLAN interfaces, setting the minimum and maximum VLAN ID to the same value ensures that only a specific VLAN ID is matched. It indicates that the VLAN interface will specifically recognize and process traffic tagged with that exact VLAN ID.

The following commands and options are used to configure double-tagged VLAN interfaces.

```

supervisor@switch: cfg> set access interface double-tagged
  <interface-name>      Name of the physical interface

supervisor@switch: cfg> set access interface double-tagged ifp-0/0/0
  <outer-vlan-min>      Outer VLAN min

supervisor@switch: cfg> set access interface double-tagged ifp-0/0/0 128
  <outer-vlan-max>      Outer VLAN max

supervisor@switch: cfg> set access interface double-tagged ifp-0/0/0 128 3000
  <inner-vlan-min>      Inner VLAN min

supervisor@switch: cfg> set access interface double-tagged ifp-0/0/0 128 3000 7
  <inner-vlan-max>      Inner VLAN max

supervisor@switch: cfg> set access interface double-tagged ifp-0/0/0 128 3000 7 7
  <cr>
aaa-profile-name        AAA profile name
access-profile-name     Access profile name
access-type             Access service type
max-subscribers-per-mac Restrict maximum subscribers per MAC address
max-subscribers-per-vlan Restrict maximum subscribers per VLAN
pppoe-pado-delay        Optional PPPoE PADO delay in seconds <1-255>
service-profile-name    Service profile name
vlan-profile-enable     Enable VLAN profiles

```

In the following example, the double-tagged access interface **ifp-0/0/0** is configured with the Outer VLAN minimum value **128** and the outer VLAN maximum value **3000**. The configuration also defines the inner VLAN minimum value **7** and Inner VLAN maximum value **7**. The Access Type is defined PPPoE, Access Profile **pppoe-dual**, and AAA Profile **aaa-radius**.

```

supervisor@switch: cfg> set access interface double-tagged ifp-0/0/0 128 3000 7 7
access-type PPPoE
supervisor@switch: cfg> set access interface double-tagged ifp-0/0/0 128 3000 7 7
access-profile-name pppoe-dual
supervisor@switch: cfg> set access interface double-tagged ifp-0/0/0 128 3000 7 7
aaa-profile-name aaa-radius
supervisor@switch: cfg> commit
supervisor@switch: cfg> show config access interface single-tagged ifp-0/0/0 128
3000 7 7
{
  "rtbrick-config:double-tagged": {
    "interface-name": "ifp-0/0/0",
    "outer-vlan-min": 128,
    "outer-vlan-max": 3000,
    "inner-vlan-min": 7,
    "inner-vlan-max": 7,
    "access-type": "PPPoE",
    "access-profile-name": "pppoe-dual",
    "aaa-profile-name": "aaa-radius"
  }
}

```



The access **interface-name** can be a physical IFP or LAG.

The following example sets a PPPoE PADO delay of 30 seconds for a double-tagged interface **ifp-0/0/0**.

```

supervisor@switch: cfg> set access interface double-tagged ifp-0/0/0 201 250 201
250
supervisor@switch: cfg> set access interface double-tagged ifp-0/0/0 201 250 201
250 access-type PPPoE
supervisor@switch: cfg> set access interface double-tagged ifp-0/0/0 201 250 201
250 access-profile-name pppoe-default-ds
supervisor@switch: cfg> set access interface double-tagged ifp-0/0/0 201 250 201
250 aaa-profile-name aaa-profile
supervisor@switch: cfg> set access interface double-tagged ifp-0/0/0 201 250 201
250 pppoe-pado-delay 30

```

## Configuring VLAN Encapsulation on Access Interface

By default, the VLAN encapsulation **0x8100** is used.

In the configuration, the provided subscriber ID is 216454257090494465, and the Subscriber IFL name is "ipoe-0/0/1/216454257090494465". The Outer VLAN and Inner VLAN IDs are both specified as '1'. The IPv6 link local address is provided as "fe80::786b:e7ff:fec0:1", and the MAC address specified is '02:00:00:00:00:01'. The instance name provided is 'default', and the gateway IFL is specified as "lo-0/0/4/1". Proxy ARP is enabled by specifying it as true. The Layer 3 MTU is set to 1500, and the tunnel type is marked as IPoE.

```

set access interface double-tagged ifp-0/0/1 1 4094 1 4094
set access interface double-tagged ifp-0/0/1 1 4094 1 4094 access-type IPOE
set access interface double-tagged ifp-0/0/1 1 4094 1 4094 outer-vlan-
encapsulation <802.1ad\|802.1q>

```

### Example:

```

{
  "subscriber_id": 216454257090494465,
  "subscriber_ifl_name": "ipoe-0/0/1/216454257090494465",
  "ifp_name": "ifp-0/0/1",
  "tagged": true,
  "outer_vlan_id": 1,
  "inner_vlan_id": 1,
  "outer_vlan_encapsulation" : "802.1ad",
  "client_mac_address": "02:00:00:00:00:01",
  "instance_name": "default",
  "description": "Subscriber IFL for 02:00:00:00:00:01@ipoe",
  "tunnel_type": "IPOE",
  "ipv6_link_local": "fe80::786b:e7ff:fec0:1",
  "gateway_ifl": "lo-0/0/4/1",
  "enable_proxy_arp": true,
  "l3_mtu": 1500
}

```

## Access Profile Configuration

You must configure an access interface with an access profile name, such as **pppoe-dual** and it is also essential to configure the properties and parameters of the access profile itself.

The following image illustrates the access interface configurations and how they are associated with the entire subscriber management configurations.

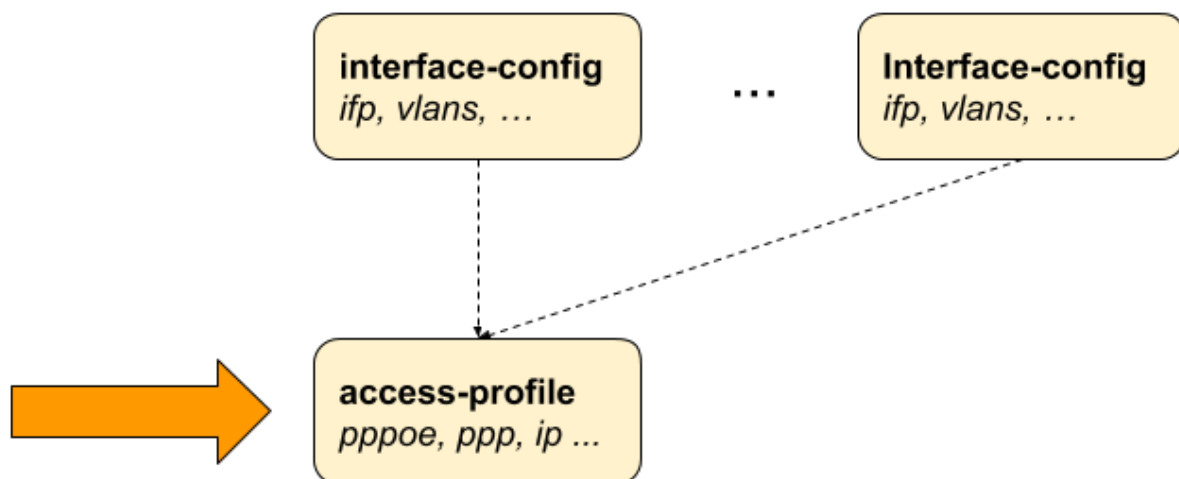

Figure 8. Access Profile Configuration

## Configuring the Access Profile

Configuring an access profile involves specifying its name and defining various parameters to control how it handles network traffic and client interactions. The following command and options allow you to configure an access profile.

```

supervisor@switch: cfg> set access access-profile
  <profile-name>          Name of the access profile

supervisor@switch: cfg> set access access-profile pppoe-dual
  <cr>
  address-family          Address-family configuration
  instance                Instance name
  protocol                Protocol configuration
    
```

The following table provides the command options/attributes and descriptions.

Attribute	Description
instance	Change routing instance.  <b>Default:</b> default

### PPPoE with IPv4 and IPv6

The following access profile configuration is for a PPPoE access profile named `pppoe-dual` that supports both IPv4 and IPv6. The instance is marked as `default`, and the session protection is enabled for PPPoE by setting the value to `true`, and the VLAN priority is set to `6`.

The configuration defines various PPP parameters such as LCP, IPCP, and so on. For LCP (Link Control Protocol), the authentication protocol is specified as `PAP_CHAP`, indicating that both `PAP` (Password Authentication Protocol) and `CHAP` (Challenge Handshake Authentication Protocol) are allowed. The `echo-interval`, which is the interval in seconds for sending LCP echo requests to check the connection, is specified as 30 seconds. The `echo-max-retransmit` parameter, which is the maximum number of retransmissions for LCP echo requests before considering the link down, is set to `3`. The configuration enables the LCP echo requests by specifying `true` for the `echo-enable` parameter.

In the configuration, both the IPCP and IP6CP are enabled by setting their values to `true`. These protocols are used to configure both the IPv4 and IPv6 settings over PPP. The source IFL (logical interface) for IPCP is specified as 'lo-0/0/0/1'. The RA

(Router Advertisement) Configuration is enabled by setting the value to 'true', which allows the router to send RA messages for IPv6 configuration. The **interval** period for the RA messages is set to 60 seconds. DHCPv6 is enabled by setting the value to **true**, which allows the device to assign IPv6 addresses to the subscribers through DHCP.

The L2TP tunnel profile is defined as **l2tp-default**, which allows the encapsulation of PPP sessions over IP networks. Both IPv4 and IPv6 address families are enabled by setting their values to **true** using the address family configurations. For IPv4, the primary DNS server is specified '198.51.100.1' and the secondary DNS server is specified '198.51.100.4'. For IPv6, the primary DNS server is specified as '2001:db8:0:100::' and the secondary DNS server is specified '2001:db8:0:104::'.

```
supervisor@switch: cfg> show config access access-profile pppoe-dual
{
  "rtbrick-config:access-profile": {
    "profile-name": "pppoe-dual",
    "instance": "default",
    "protocol": {
      "pppoe": {
        "enable": "true",
        "session-protection": {
          "enable": "true"
        },
        "vlan-priority": 6
      },
      "ppp": {
        "lcp": {
          "authentication-protocol": "PAP_CHAP",
          "echo-interval": 30,
          "echo-max-retransmit": 3,
          "echo-enable": "true"
        },
        "ipcp": {
          "enable": "true",
          "source-ifl": "lo-0/0/0/1"
        },
        "ip6cp": {
          "enable": "true"
        }
      },
      "ra": {
        "enable": "true",
        "interval": 60
      },
      "dhcpv6": {
        "enable": "true"
      },
      "l2tp": {
        "tunnel-profile": "l2tp-default"
      }
    },
    "address-family": {
      "ipv4": {
```

```
    "enable": "true",
    "primary-dns": "198.51.100.1",
    "secondary-dns": "198.51.100.4"
  },
  "ipv6": {
    "enable": "true",
    "primary-dns": "2001:db8:0:100::",
    "secondary-dns": "2001:db8:0:104::"
  }
}
```

## IPoE with IPv4 and IPv6

The example configuration below sets up an IPoE access profile named 'ipoe-dual' to handle IPoE sessions, which support both IPv4 and IPv6 address families. The router acts as a DHCP server for both protocols, assigning IP addresses and DNS server information to client devices.

The profile name is **ipoe-dual**. By setting the value to **true**, this profile enables both DHCP and DHCPv6 protocols. The mode is defined as **server** for both DHCP and DHCPv6, which allows the router to act as a server for IPv4 and IPv6. The IPv4 address family is configured for the access profile by setting the value to **true**. For IPv4, proxy ARP is enabled by setting **proxy-arp-enable** to true.

The IPv4 address family is configured for the access profile by setting the value to **true**. For IPv4, proxy ARP is enabled by setting **proxy-arp-enable** to true. This allows the router to respond to ARP requests on behalf of other hosts.

The pool name **ipoe** indicates the IPv4 address allocation to client devices. The primary DNS server for IPv4 is set to '198.51.100.1', and the secondary DNS server is specified as '198.51.100.4'.

The configuration includes various parameters for IPv6. The IPv6 pool name is **ipoe-ia-na**, which provides IPv6 addresses to subscribers. The **prefix-delegation-pool-name** parameter is set as **ipoe-ia-pd** for IPv6 prefix delegation. The primary and secondary DNS servers for IPv6 are specified as '2001:db8:0:100::' and '2001:db8:0:104::' respectively.

```
supervisor@switch: cfg> show config access access-profile ipoe-dual
{
  "rtbrick-config:access-profile":{
    "profile-name":"ipoe",
    "protocol":{
      "dhcp":{
```



```

        "enable": "true",
        "mode": "server"
    },
    "dhcpv6": {
        "enable": "true",
        "mode": "server"
    }
},
"address-family": {
    "ipv4": {
        "enable": "true",
        "proxy-arp-enable": "true",
        "pool-name": "ipoe",
        "primary-dns": "198.51.100.1",
        "secondary-dns": "198.51.100.4"
    },
    "ipv6": {
        "enable": "true",
        "pool-name": "ipoe-ia-na",
        "prefix-delegation-pool-name": "ipoe-ia-pd",
        "primary-dns": "2001:db8:0:100::",
        "secondary-dns": "2001:db8:0:104::"
    }
}
}
}
}

```

## Configuring IPv4

To make IPv4 available for access protocols such as PPP (PPPoE) or DHCP (IPoE), you must explicitly enable the IPv4 address family within the access profile.

```

supervisor@switch: cfg> set access access-profile pppoe-dual address-family ipv4
<cr>
enable                Enable IPv4
pool-name             Local IPv4 pool name
primary-dns           Primary DNS server
proxy-arp-enable      Enable Proxy ARP
secondary-dns         Secondary DNS server
static-ipv4           Static address
dad-enable            Enable/disable IPv4 duplicate address detection (Enabled
by default)

```

The following table provides the command options/attributes and descriptions.

Attribute	Description
enable	Enable IPv4  <b>Default:</b> false

Attribute	Description
pool-name	The <b>pool-name</b> option (optional) allows assigning the IPv4 address from a locally managed pool. For more details, see <a href="#">Address Pool Configuration</a> . This address is used by protocols like PPP IPCP (PPPoE) or DHCP (IPoE) as a client or peer IPv4 address.
primary-dns secondary-dns	The primary DNS and secondary DNS servers configured are used by protocols such as PPP (PPPoE) or DHCP (IPoE) and advertised to the client.
proxy-arp-enable	Enable (or disable) proxy ARP support for IPoE subscribers. When proxy ARP is enabled, if the RBFS device receives an ARP request from the subscriber for which it has a route to the target (destination) IP address, the RBFS device responds by sending a proxy ARP reply packet containing its own MAC address. The host/subscriber that sent the ARP request then sends the actual destined packets to RBFS, which forwards them to the intended destination.  <b>Default:</b> NONE.
static-ipv4	The <b>static-ipv4</b> attribute is used to configure a fixed IPv4 address for all clients connected under a specific access profile. This is particularly useful in scenarios requiring a consistent IP address for services.  <div style="display: flex; align-items: center;">  <div style="border-left: 1px solid black; padding-left: 10px;">                         This feature should be only used with caution.                     </div> </div>
dad-enable	With the option, you can enable or disable the Duplicate Address Detection (DAD) for IPv4 addresses. It prevents address conflicts by verifying that an IPv4 address is not already in use on the network before it is assigned to an interface.  <b>Default:</b> true

## Configuring IPv6

To make IPv6 available for access protocols such as PPP (PPPoE) or DHCP (IPoE), you must explicitly enable the IPv4 address family within the access profile.

```

supervisor@switch: cfg> set access access-profile pppoe-dual address-family ipv6
<cr>
enable                               Enable IPv6
pool-name                             Local IPv6 pool name
prefix-delegation-pool-name          Local IPv6 prefix delegation pool name
primary-dns                           Primary DNS server
secondary-dns                         Secondary DNS server
dad-enable                             Enable/disable IPv6 duplicate address detection
(Enabled by default)
    
```

The following table provides the command options/attributes and descriptions.

Attribute	Description
enable	Enable IPv6  <b>Default:</b> false
pool-name prefix-delegation-pool-name	The <b>pool-name</b> attribute (optional) allows to assign of the IPv6 prefix from a locally managed pool. For more details, see <a href="#">Address Pool Configuration</a> . This prefix is advertised by ICMPv6 router advertisements to the client where prefixes from optional <b>prefix-delegation-pool-name</b> are advertised by DHCPv6 as delegated prefix (IA_PD).
primary-dns secondary-dns	The primary DNS and secondary DNS servers configured are used by protocols such as ICMPv6 router advertisements or DHCPv6 and advertise to the client.
dad-enable	Enable (or disable) IPv6 duplicate address detection.  <b>Default:</b> true

## Enabling IPv6 Router Advertisement

IPv6 Router Advertisement (RA) is a component of the IPv6 Neighbor Discovery Protocol (NDP). It is used by routers to broadcast their availability and provide various network parameters to devices that support IPv6 on the network. Enabling Router Advertisement is crucial for the automatic configuration of IPv6 addresses and other settings on IPv6-enabled devices.

```

supervisor@switch: cfg> set access access-profile pppoe-dual protocol ra
<cr>
enable                               Enable IPv6 router-advertisement
interval                             Interval
lifetime                             Lifetime
    
```

preferred-lifetime      Preferred lifetime

The following table provides the command options/attributes and descriptions.

Attribute	Description
enable	Enable IPv6 router advertisement.  <b>Default:</b> false
interval	IPv6 router advertisements interval in seconds. Sets the interval at which the Router Advertisement messages are sent.  <b>Default:</b> 0 (disabled)
lifetime	The valid lifetime for the prefix in seconds.  <b>Default:</b> 14400
preferred-lifetime	The preferred lifetime for the prefix in seconds.  <b>Default:</b> 1800

### Enabling DHCPv4

To enable and configure DHCPv4 on the access profile, use the following command. This setup allows the access profile to handle DHCP requests and provide IP addresses to clients.

```

supervisor@switch: cfg> set access access-profile ipoe-dual protocol dhcp
<cr>
enable                                    Enable DHCP
lease-time                                DHCP lease time in seconds
mode                                      DHCP mode
    
```

The following table provides the command options/attributes and descriptions.

Attribute	Description
enable	Enable DHCP.  <b>Default:</b> false

Attribute	Description
dhcp-mode	<p>This option specifies the DHCP mode for handling DHCP requests, distinguishing between local handling and forwarding through relay or proxy. While both relay and proxy forward requests, the proxy mode provides an additional layer of abstraction by concealing the actual DHCP server's address.</p> <p><b>Default:</b> server <b>Values:</b> server, relay, proxy</p> <p>   Proxy mode is, currently, not supported.</p>
lease-time	<p>Define the duration of IP address leases, in seconds.</p> <p><b>Default:</b> 300</p>
dhcp-server	Configure global DHCP server.

## Configuring DHCPv6

To configure DHCPv6 on an access profile, use the following command. This setup enables DHCPv6 functionality, prefix lifetimes, and the operating mode.

```

supervisor@switch: cfg> set access access-profile pppoe-dual protocol dhcpv6
<cr>
enable           Enable DHCPv6
lifetime         Lifetime
preferred-lifetime Preferred lifetime
mode             DHCPv6 mode
    
```

The following table provides the command options/attributes and descriptions.

Attribute	Description
enable	<p>Enable DHCPv6.</p> <p><b>Default:</b> false</p>

Attribute	Description
mode	<p>This option defines the DHCPv6 mode where the server handles DHCPv6 requests locally and relay/proxy forwards those to the configured servers. The difference between relay and proxy is that proxy can hide the actual DHCPv6 server.</p> <p><b>Default:</b> server <b>Values:</b> server, relay, proxy</p>
lifetime	<p>The duration for which the advertised prefix is valid. This is the total time the prefix remains usable before it needs to be renewed. Set this to the desired lifetime in seconds.</p> <p><b>Default:</b> 14400</p>
preferred-lifetime	<p>Set the lifetime for IPv6 prefixes, in seconds. It defines the duration during which the prefix is preferred for use. It should be less than or equal to the lifetime. If set higher than the lifetime, it will be adjusted to match the lifetime.</p> <p>The values for T1 and T2 are 0.5 and 0.8 times the shortest preferred lifetime.</p> <p><b>Default:</b> 1800</p>
dhcpv6-server	<p>Configure DHCPv6 server.</p>

## Configuring PPPoE and PPP

The PPPoE protocol must be explicitly enabled in the access profile to allow PPPoE sessions.

```
supervisor@switch: cfg> set access access-profile pppoe-dual protocol pppoe enable
true
```

### PPPoE

The PPPoE configuration allows changing the default behavior of the PPPoE protocol.

```
supervisor@switch: cfg> set access access-profile pppoe-dual protocol pppoe
<cr>
enable          Enable PPPoE
```

max-outstanding	Maximum outstanding PPPoE sessions
session-protection	PPPoE session protection

The following table provides the command options/attributes and descriptions.

Attribute	Description
enable	Enable PPPoE.  <b>Default:</b> false
max-outstanding	Maximum outstanding PPPoE sessions.  <b>Default:</b> 64 <b>Range:</b> 1 - 65535

When PPPoE session protection is enabled, any short-lived or failed sessions are logged. By default, a session that does not remain established for at least 60 seconds (min-uptime) is classified as a failed or short-lived session. Such failures trigger a block on new sessions for this IFP and VLAN for one second (min-lockout) by default. With each subsequent failed session, the lockout duration increases exponentially until it reaches a maximum of 300 seconds (max-lockout). If no failed sessions occur for 900 seconds, the lockout interval is reset (currently, not configurable).

PPPoE session protection also logs the last subscriber ID and terminates the session with a code that indicates the reason for the failure.

```

supervisor@switch: cfg> set access access-profile pppoe-dual protocol pppoe
session-protection
  <cr>
  enable           Enable PPPoE session protection
  max-lockout      Session protection maximum lockout time in seconds
  min-lockout      Session protection minimum lockout time in seconds
  min-uptime       Session protection minimum uptime in seconds
    
```

Attribute	Description
enable	Enables PPPoE session protection.  <b>Default:</b> false
min-lockout	Session protection minimum lockout time (in seconds).  <b>Default:</b> 1

Attribute	Description
max-lockout	Session protection maximum lockout time (in seconds).  <b>Default:</b> 300
min-uptime	Session with an uptime less than this will trigger protection (in seconds).  <b>Default:</b> 60

## Configuring PPP LCP

The PPP Link Control Protocol (LCP) configuration allows changing the default behavior of the LCP protocol.

```

supervisor@switch: cfg> set access access-profile pppoe-dual protocol ppp lcp
<cr>
authentication-protocol  Authentication protocol
config-nak-max           Max configure-reject/nak <1-255>
echo-enable              Enable echo requests
echo-interval            Echo interval in seconds <1-255>
echo-max-retransmit     Echo maximum retries <1-255>
lcp-loop-detection      Loop detection
mru                      Maximum local MRU <1280-1500>
mru-negotiation          MRU negotiation
mtu                      Maximum local MTU <1280-1500>
retransmit-interval     Retransmit interval in seconds <1-255>
retransmit-max          Maximum retries <1-255>
    
```

The following table provides the command options/attributes and descriptions.



Attribute	Description
authentication-protocol	<p>This option allows you to specify the authentication protocol used during the LCP negotiation phase. By default, PPP authentication is set to <b>PAP_CHAP</b>. This can be changed by setting the authentication protocol to either <b>PAP</b>, <b>CHAP</b>, <b>PAP_CHAP</b> or <b>CHAP_PAP</b>. The Password Authentication Protocol (PAP) is (defined in RFC 1334) and receives the password as a plain text value from the client. The Challenge Handshake Authentication Protocol (CHAP) is (defined in RFC 1994) provides a more secure way to authenticate the client without exchanging plaintext secrets. The <b>PAP_CHAP</b> option first attempts to authenticate using <b>PAP</b> with a fallback to <b>CHAP</b>, if <b>PAP</b> is rejected by the client. Alternatively, <b>CHAP_PAP</b> starts with CHAP and falls back to PAP if CHAP is rejected by the client.</p> <p><b>Default:</b> PAP_CHAP</p>
echo-enable	<p>By default, RBFS responds to LCP echo requests but does not initiate them unless <b>echo-enable</b> is set to true.</p> <p><b>Default:</b> true</p>
echo-interval	<p>LCP echo request interval in seconds.</p> <p><b>Default:</b> 30 <b>Range:</b> 1 - 255</p>
echo-max-retransmit	<p>LCP echo request retransmissions.</p> <p><b>Default:</b> 3 <b>Range:</b> 1 - 255</p>
mru-negotiation	<p>Negotiate MRU</p> <p><b>Default:</b> true</p>
mru	<p>Maximum local MRU (peer MTU)</p> <p><b>Default:</b> 1492 <b>Range:</b> 1280 - 1500</p>
mtu	<p>Maximum local MTU (peer MRU)</p> <p><b>Default:</b> 1492 <b>Range:</b> 1280 - 1500</p>

Attribute	Description
lcp-loop-detection	<p>This is used during the PPP connection process to detect and prevent loops in the network. It is achieved through the negotiation and validation of 'magic numbers'. Magic numbers are unique values used by both ends of a PPP connection to ensure that the data sent is not simply being looped back from the other end. By default, the negotiation and validation of magic numbers are enabled, providing protection against looping connections. You can disable loop detection by setting <code>lcp-loop-detection</code> to false. However, it is NOT recommended to disable LCP loop detection.</p> <p><b>Default:</b> true</p>
retransmit-interval	<p>The LCP request retransmission interval.</p> <p><b>Default:</b> 5 <b>Range:</b> 1 - 255</p>
retransmit-max	<p>The LCP requests retransmission before the session is terminated if no response is received.</p> <p><b>Default:</b> 3 <b>Range:</b> 1 - 255</p>
config-nak-max	<p>The option <code>config-nak-max</code> defines the maximum PPP LCP configuration <code>reject/nak</code> messages that can be sent or received before the session is terminated.</p> <p><b>Default:</b> 16 <b>Range:</b> 1 - 255</p>

## Configuring PPP IPCP

To enable IPv4 over PPPoE, both the address-family IPv4 and the protocol PPP IPCP must be explicitly enabled in the access profile. Additionally, the `source-ifl` option is a mandatory configuration that specifies the logical interface from which the local IPv4 address will be derived.

```

supervisor@switch: cfg> set access access-profile pppoe-dual protocol ppp ipcp
<cr>
config-nak-max      Max configure-reject/nak <1-255>
enable              Enable PPP IPCP
passive             Passive mode
retransmit-interval Retransmit interval in seconds <1-255>
retransmit-max      Maximum retries <1-255>
source-ifl          Source IFL
    
```

The following table provides the command options/attributes and descriptions.

Attribute	Description
enable	Enable IPCP  <b>Default:</b> false
passive	IPCP passive mode  <b>Default:</b> false
source-ifl	This setting is required and should be set to obtain the local IPv4 address from a specific logical interface. It should be configured to use the loopback interface of the corresponding routing instance. If a <b>source-ifl</b> is chosen from a different routing instance, it will not change the routing instance assigned to the subscriber. Also, the routing instance can be changed through a RADIUS <b>Access-Accept</b> message without affecting the <b>source-ifl</b> . This means that the <b>source-ifl</b> can still be used to obtain the local IPv4 address, even if it belongs to a different routing instance. Although, it is not mandatory, it is recommended to configure the same loopback address across all routing instances where a subscriber might be located.
retransmit-interval	The IPCP request retransmission interval.  <b>Default:</b> 5 <b>Range:</b> 1 - 255
retransmit-max	The IPCP requests retransmission before the session is terminated if no response is received.  <b>Default:</b> 8 <b>Range:</b> 1 - 255
config-nak-max	The option config-nak-max defines the maximum PPP IPCP configuration reject/nak messages that can be sent or received before the session is terminated.  <b>Default:</b> 8 <b>Range:</b> 1 - 255

## Configuring PPP IP6CP

To use IPv6 over PPPoE, you must explicitly enable both the IPv6 address family

and the PPP IP6CP protocol.

The following command demonstrates how to enable PPP IP6CP in the `pppoe-dual` access profile.

```

supervisor@switch: cfg> set access access-profile pppoe-dual protocol ppp ip6cp
<cr>
config-nak-max      Max configure-reject/nak <1-255>
enable              Enable PPP IP6CP
passive             Passive mode
retransmit-interval Retransmit interval in seconds <1-255>
retransmit-max      Maximum retries <1-255>
    
```

The following table provides the command options/attributes and descriptions.

Attribute	Description
enable	Enable IP6CP.  <b>Default:</b> false
passive	IP6CP passive mode.  <b>Default:</b> false
retransmit-interval	This option sets the interval, in seconds, between retransmissions, for IP6CP requests.  <b>Default:</b> 5 <b>Range:</b> 1 - 255
retransmit-max	This option sets the maximum number of retransmission attempts. The IP6CP requests retransmission before the session is terminated if no response is received.  <b>Default:</b> 8 <b>Range:</b> 1 - 255
config-nak-max	The option defines the maximum PPP IP6CP configuration <code>reject/nak</code> (Negative Acknowledgement) messages that can be sent or received before the session is terminated.  <b>Default:</b> 6 <b>Range:</b> 1 - 255

## DHCP Server Configuration

You can configure the DHCP server for IP address allocation using the following command and options.

## Configuring DHCPv4 Server

The following commands and options are used to configure a DHCPv4 server.

```

supervisor@switch: cfg> set access dhcp-server
dhcp-server          Global DHCP server configuration

supervisor@switch: cfg> set access dhcp-server server-example
<cr>
address              DHCP server address
routing-instance     Instance name from which DHCP server is reachable
source-address       Source address used for DHCP packets

```

The following example shows a DHCPv4 server configuration. It indicates the DHCP server name as 'dhcp-server1', which is the identifier for the DHCP server. The DHCP server's IP address is specified as '172.16.0.10', and the source IP address is specified as '172.16.0.2', which is used by the DHCP server when sending out packets. The routing instance name is set as 'default', which indicates that the DHCP server is accessible through the default instance.

```

supervisor@switch: cfg> show config access dhcp-server
{
  "rtbrick-config:dhcp-server": [
    {
      "server-name": "dhcp-server1",
      "address": "172.16.0.10",
      "source-address": "172.16.0.2",
      "routing-instance": "default"
    }
  ]
}

```

## Configuring DHCPv6 Server

The following commands and options are used to configure a DHCPv6 server.

```

supervisor@switch: cfg> set access dhcpv6-server dhcpv6-example
<cr>
address              DHCP server address
routing-instance     Instance name from which DHCP server is reachable
source-address       Source address used for DHCP packets

```

The following example shows a DHCPv6 configuration. It shows the DHCPv6 server name is specified as 'dhcpv6-server1' which is the identifier for the DHCPv6 server. The IP address is specified as '172:16::2'. The source IP address is specified as '172:16::10', which is used by the DHCPv6 server when sending out packets. The routing instance name is set as 'default'. It indicates the DHCPv6 server is

accessible through the default instance.

```

supervisor@switch: cfg> show config access dhcpv6-server
{
  "rtbrick-config:dhcpv6-server": [
    {
      "server-name": "dhcpv6-server1",
      "address": "172:16::2",
      "source-address": "172:16::10",
      "routing-instance": "default"
    }
  ]
}
    
```

## AAA Profile Configuration

**Table:** [global.access.aaa.profile.config](#)

The AAA profile for subscriber access is a mandatory configuration that serves as a cornerstone for managing and tracking subscriber activities. It ensures that all subscribers are authenticated before accessing services, authorized to use those services, and accounted for billing and monitoring purposes.

The following diagram illustrates how the AAA profile is associated with various subscriber management tasks.

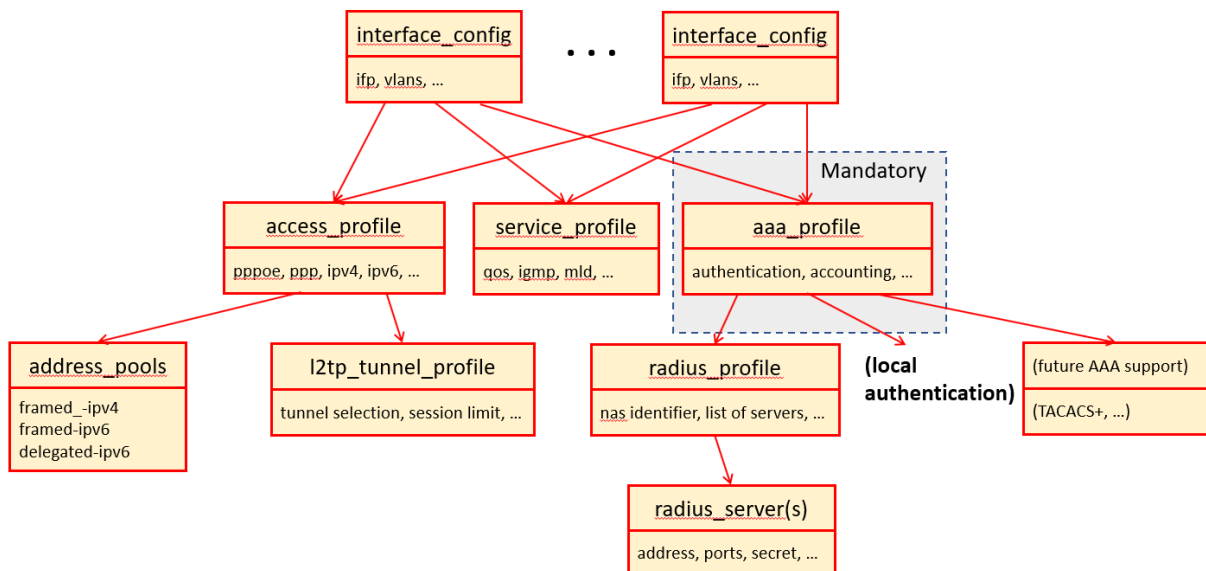

Figure 9. AAA Profile Configuration

## Configuring the AAA Profile

The following command and options allow you to configure an AAA profile.

```
supervisor@switch: cfg> set access aaa-profile
  <profile-name>      Name of the AAA profile

supervisor@switch: cfg> set access aaa-profile aaa-example
  <cr>
  aaa-radius-profile  AAA RADIUS profile name
  accounting          Accounting options
  authentication      Authentication options
  idle-timeout        Idle timeout in seconds (0 == infinity)
  session-timeout     Session timeout in seconds (0 == infinity)
```

This following example demonstrates a typical AAA (Authentication, Authorization, and Accounting) profile configuration for RADIUS authentication and accounting. The profile name is 'aaa-radius'.

The **session-timeout** value is set to '0', meaning there is no session timeout and the session can remain active indefinitely. The idle timeout value is also '0', indicating no idle timeout, so the session will not be terminated due to inactivity.

The parameter **aaa-radius-profile** is set to 'radius-default', which maps the AAA profile to the specific RADIUS profile named 'radius-default'. The RADIUS profile contains the necessary configuration details for communicating with the RADIUS server. In this profile, RADIUS is the selected method for handling all authentication requests. The **order** parameter indicates that RADIUS is the primary and only method of authentication configured.

For accounting, the order is specified as RADIUS, indicating that all accounting data is sent to the RADIUS server. The parameter **session-id-format** is set to "DEFAULT".

The ingress accounting-source is "POLICER", and the egress accounting source is "CLASS". "POLICER" indicates that the accounting data is based on a traffic policer, while "CLASS" indicates that the accounting data is based on traffic classes.

The **class-byte-adjustment-value** parameter is set to 16, adjusting the byte count for outgoing traffic by a specific value (16).

```
supervisor@switch: cfg> show config access aaa-profile aaa-radius
{
  "rtbrick-config:aaa-profile": {
    "profile-name": "aaa-radius",
    "session-timeout": 0,
    "idle-timeout": 0,
```

```

"aaa-radius-profile": "radius-default",
"authentication": {
  "order": "RADIUS"
},
"accounting": {
  "order": "RADIUS",
  "session-id-format": "DEFAULT",
  "ingress": {
    "accounting-source": "POLICER"
  },
  "egress": {
    "accounting-source": "CLASS",
    "class-byte-adjustment-value": 16
  }
}
}
}
}

```

Attribute	Description
session-timeout	<p>The session timeout defines the maximum (uptime) duration, in seconds, that a subscriber can remain connected before the session is automatically terminated. The value '0' indicates that the session has no time limit and can continue indefinitely.</p> <p><b>Default: 0 Range: 0 - 4294967295</b></p>
idle-timeout	<p>The idle timeout is the time, in seconds, after which a subscriber will be disconnected if no data is being transmitted through their outgoing logical interface (IFL). Control traffic is not included in these statistics. The subscriber is not considered idle as long as outgoing traffic is detected. The idle timeout is not limited but should be set to at least double the time of the logical interface statistics counter update interval (between 5 to 45 seconds). The idle timeout does not have a specific limit, but it is recommended to set it to at least double the time of the logical interface statistics counter update interval (which is between 5 to 45 seconds). Therefore, it is advisable to set a minimum idle timeout of 90 seconds. The value '0' means that the timeout is infinite.</p> <p><b>Default: 0 Range: 0 - 4294967295</b></p>



Attribute	Description
aaa-radius-profile	The RADIUS profile, (for more details, see <a href="#">RADIUS Profile Configuration</a> ), which is used if RADIUS authentication or accounting is enabled.

## Configuring Authentication

RBFS supports the authentication methods: NONE, LOCAL, and RADIUS.

- NONE: Disables authentication, accepting all credentials without verification.
- LOCAL: Authenticates the subscriber based on locally defined user profiles. For more details, refer to [User Profile Configuration](#).
- RADIUS: Authenticates the subscriber remotely by sending an authentication request to the configured RADIUS servers.



The authentication method DOMAIN is currently not supported.

Certain authentication methods can be combined together such as the following:

**LOCAL\_RADIUS:** In this method, the system attempts to authenticate the subscriber at first locally. If no matching local user is found, the system attempts authentication via RADIUS. If a local user is found but the password does not match, the subscriber is immediately rejected, and no RADIUS request is made.

**RADIUS\_LOCAL:** In this method, the system attempts to authenticate the subscriber at first through RADIUS. If the RADIUS server rejects the request, the subscriber is immediately disconnected. However, if no response (timeout) is received from any configured RADIUS server, the system falls back to local authentication.

The following command and options allow you to define the order of authentication methods.

```
supervisor@switch: cfg> set config access aaa-profile aaa-default authentication
  <cr>
  delimiter          Delimiter string
  order              Authentication order
```

Attribute	Description
order	<p>This option defines the order of authentication methods.</p> <p><b>Default:</b> NONE <b>Values:</b> LOCAL, LOCAL_RADIUS, RADIUS, RADIUS_LOCAL</p>
delimiter	<p>This option defines the delimiter for domain authentication.</p> <p><b>Default:</b> @</p> <div style="display: flex; align-items: center; margin-top: 10px;">  <div style="border-left: 1px solid black; padding-left: 10px;"> <p>Currently, the <b>delimiter</b> option is not supported.</p> </div> </div>

### Configuring Accounting

Subscriber accounting involves tracking and recording a subscriber’s session duration and data usage. This process includes two main components:

- Time Accounting: Measures the duration of a subscriber’s session.
- Volume Accounting: Tracks the number of packets and bytes transmitted or received.

Volume accounting operates in both directions (ingress and egress), and these can be configured independently.

Note: Currently, RBFS supports RADIUS as the only accounting method.

The following command and options are used to configure accounting for the default AAA profile named **aaa-default**. The 'egress' option allows you configure accounting for outgoing traffic, and the 'ingress' option allows to set accounting for incoming traffic. The 'interim-interval' option sets the interval, in seconds, for sending interim accounting updates. The 'order' option determines the sequence in which accounting records are processed or sent. This is helpful when multiple accounting methods are used. The 'session-id-format' option allows you to define the format of the accounting session ID attribute, which uniquely identifies each accounting session.

```

supervisor@switch: cfg> set config access aaa-profile aaa-default accounting
<cr>
egress          Egress volume accounting option.
ingress         Ingress volume accounting option
interim-interval Accounting interim interval in seconds (0 == disabled)
order           Accounting order
    
```

session-id-format

Accounting Session ID format

Attribute	Description												
order	This option defines the order of accounting methods.  <b>Default:</b> NONE												
interim-interval	The interim interval specifies the time between interim accounting requests in seconds where 0 means disabled.  <b>Default:</b> 0 <b>Range:</b> 0 - 4294967295												
session-id-format	The format of the Accounting-Session-Id (RADIUS attribute 44).  <table border="1"> <thead> <tr> <th>Name</th> <th>Format</th> <th>Example</th> </tr> </thead> <tbody> <tr> <td>DEFAULT</td> <td>&lt;subscriber-id&gt;.&lt;timestamp&gt;</td> <td>72339069014639577.1551943760</td> </tr> <tr> <td>BRIEF</td> <td>&lt;subscriber-id&gt;&gt;</td> <td>72339069014639577</td> </tr> <tr> <td>EXTENSIVE</td> <td>&lt;subscriber-id&gt;.&lt;ifp&gt;.&lt;outer-vlan&gt;.&lt;inner-vlan&gt;.&lt;client-mac&gt;.&lt;session-id&gt;.&lt;timestamp&gt;</td> <td>72339069014639577.ifp-0/0/0.128.7.01:02:03:04:05:05.1.1551943760</td> </tr> </tbody> </table> <b>Default:</b> DEFAULT <b>Values:</b> BRIEF, EXTENSIVE     Currently, only DEFAULT is supported.	Name	Format	Example	DEFAULT	<subscriber-id>.<timestamp>	72339069014639577.1551943760	BRIEF	<subscriber-id>>	72339069014639577	EXTENSIVE	<subscriber-id>.<ifp>.<outer-vlan>.<inner-vlan>.<client-mac>.<session-id>.<timestamp>	72339069014639577.ifp-0/0/0.128.7.01:02:03:04:05:05.1.1551943760
Name	Format	Example											
DEFAULT	<subscriber-id>.<timestamp>	72339069014639577.1551943760											
BRIEF	<subscriber-id>>	72339069014639577											
EXTENSIVE	<subscriber-id>.<ifp>.<outer-vlan>.<inner-vlan>.<client-mac>.<session-id>.<timestamp>	72339069014639577.ifp-0/0/0.128.7.01:02:03:04:05:05.1.1551943760											

### Configuring Accounting Adjustments

The accounting adjustment feature enables basic counter modifications for the configured accounting method, such as RADIUS accounting. This configuration is necessary to normalize counters across different platforms in each direction. On Broadcom Q2C and Q2A based platforms, packets are counted in the size they enter the switch. Without adjustment, egress accounting would count downstream traffic as received from the core, complete with MPLS labels, while ingress accounting typically includes VLAN headers and/or PPPoE headers.

This counter adjustment aims to normalize counters with diverse encapsulations (double-tagged, untagged, and so on), potentially aligning to L3 counters (IP header and payload) as an example, or exclusively adapting egress traffic to match the outgoing packet encapsulation. The possibility for separate adjustment configurations per direction allows parity in the counters for both ingress and egress.

### **Example Scenario:**

In a scenario where packets enter a device with various encapsulations like PPPoE headers, MPLS labels, or VLAN tags, the system may count these additional headers in the packet size if the adjustment feature is not enabled. This can cause discrepancies in accounting reports.

For instance, an egress interface where traffic exits the device and goes to subscribers. If this traffic originally came from the core network with MPLS labels attached, the system counts the bytes of those labels in its accounting, inflating the byte count. Similarly, on the ingress side, the device counts VLAN tags or PPPoE headers, further impacting accurate accounting reports. To address this issue, you can configure a byte adjustment on both the ingress and egress sides to normalize these counters.

In RBFS, two configuration options are available for to achieve this: the **byte adjustment value** and the **byte adjustment factor**. The option **byte adjustment value**, which can be positive or negative (for example, -20 or 20), adjusts the byte count by a specific amount. Any decimal digits in the adjustment value are rounded to the nearest whole number (for example, 20.2 becomes 20). The option **byte adjustment factor**, which is less commonly used, adjusts the byte count by a percentage. It accepts positive values and considers up to two decimal places, such as 0.98 for a 2% reduction or 1.02 for a 2% increase.

### **Ingress Accounting**

Subscriber ingress accounting refers to the process of measuring and recording the data usage or traffic that enters a subscriber interface (upstream).

The following command and options allow you to set data usage accounting for incoming traffic.

```
supervisor@switch: cfg> set config access aaa-profile aaa-default accounting
  ingress
```

```

<cr>
accounting-source          Source of session ingress counter
byte-adjustment-factor    Adjust ingress LIF counters by factor
byte-adjustment-value     Adjust ingress LIF counters by N bytes per
packet
policer-byte-adjustment-factor Adjust ingress policer counters by factor
policer-byte-adjustment-value Adjust ingress policer counters by N bytes per
packet
    
```

Attribute	Description
accounting-source	<p>This option provides control over the counters used for subscriber ingress accounting when RADIUS accounting is enabled. The counters in question are the RADIUS attributes <b>Acct-Input-Packets</b> (47), <b>Acct-Input-Octets</b> (42), and <b>Acct-Input-Gigawords</b> (52).</p> <p>By default, the policer statistics (<b>POLICER</b>) are utilized, which represent the total traffic accepted across all policer levels (1-4). However, ingress control traffic is subject to a separate control plane policer and is therefore not included in the session policer statistics. Consequently, policers are necessary if session accounting is required.</p> <p>Alternatively, the logical interface (LIF) statistics can be used, which capture all received traffic, including control traffic and the traffic that is dropped by the ingress policer. It is important to note that this option may NOT be available on all platforms.</p> <p><b>Default:</b> POLICER <b>Values:</b> POLICER, LIF</p>
byte-adjustment-value	<p>Adjusts ingress LIF counters by +/- N bytes per packet. It allows you to adjust the ingress LIF counters by adding or subtracting a specified number of bytes per packet.</p> <p><b>Default:</b> 0.00 <b>Range:</b> -32 to 32</p>
byte-adjustment-factor	<p>Adjust the ingress LIF counters by applying a specified factor. (This adjustment is made after the <b>byte-adjustment-value</b> is applied).</p> <p><b>Default:</b> 1.00 <b>Range:</b> 0.00 - 2.00</p>

Attribute	Description
policer-byte-adjustment-value	<p>Adjusts ingress POLICER counters by +/- N bytes per packet. It adjusts the ingress POLICER counters by adding or subtracting a specified number of bytes per packet.</p> <p><b>Default:</b> 0.00 <b>Range:</b> -32 to 32</p>
policer-byte-adjustment-factor	<p>Adjusts the ingress POLICER counters by applying a specified factor. This adjustment is also executed after the <b>policer-byte-adjustment-value</b> is applied.</p> <p><b>Default:</b> 1.00 <b>Range:</b> 0.00 - 2.00</p>

### Egress Accounting

Subscriber egress accounting refers to the process of measuring and recording the data usage or traffic that is sent from a subscriber interface (downstream).

The following command and options allow you to set data usage accounting for outgoing traffic.

```

supervisor@switch: cfg> set config access aaa-profile aaa-default accounting
egress
  <cr>
  accounting-source           Source of session egress counter
  byte-adjustment-factor      Adjust egress LIF counters by a factor
  byte-adjustment-value       Adjust egress LIF counters by N bytes per packet
  class-byte-adjustment-factor Adjust egress class counters by a factor
  class-byte-adjustment-value Adjust egress class counters by N bytes per packet
    
```

Attribute	Description
accounting-source	<p>This option provides control over the counters used for egress session accounting when RADIUS accounting is enabled. The counters are the RADIUS attributes: <b>Acct-Output-Packets</b> (48), <b>Acct-Output-Octets</b> (43), and <b>Acct-Output-Gigawords</b> (53).</p> <p>By default, the class statistics (<b>CLASS</b>) are used, which represent the total traffic accepted across all queues. However, the egress control traffic is sent directly to the IFP and is, therefore, not included in the session class statistics. As a result, QoS is necessary for enabling the egress session accounting.</p> <p>As an alternative, the logical interface (LIF) statistics can be used to account for all transmitted traffic, excluding control traffic. However, this option may not be supported on all platforms.</p> <p><b>Default:</b> CLASS <b>Values:</b> CLASS, LIF</p>
byte-adjustment-value	<p>Adjust egress LIF counters by +/- N bytes per packet. That is, adjust egress LIF counters by adding or subtracting a specified number of bytes per packet.</p> <p><b>Default:</b> 0.00 <b>Range:</b> -32 to 32</p>
byte-adjustment-factor	<p>Adjust egress LIF counters by applying a specified factor. This adjustment is made after the <b>byte-adjustment-value</b> is applied.</p> <p><b>Default:</b> 1.00 <b>Range:</b> 0.00 to 2.00</p>
class-byte-adjustment-value	<p>Adjusts egress CLASS (queue) counters by adding or subtracting a specified number of bytes per packet (+/- N bytes per packet).</p> <p><b>Default:</b> 0.00 <b>Range:</b> -32 to 32</p>

Attribute	Description
class-byte-adjustment-factor	Adjust egress CLASS (queue) counters by applying a specified factor. This adjustment is also made after the <b>class-byte-adjustment-value</b> is applied.  <b>Default:</b> 1.00 <b>Range:</b> 0.00 to 2.00

## RADIUS Profile Configuration

Subscriber management allows the configuration of a RADIUS profile, which is mandatory if RADIUS is used for authentication or accounting.

The diagram below illustrates how the RADIUS profile is associated with the subscriber management tasks at a broader level.

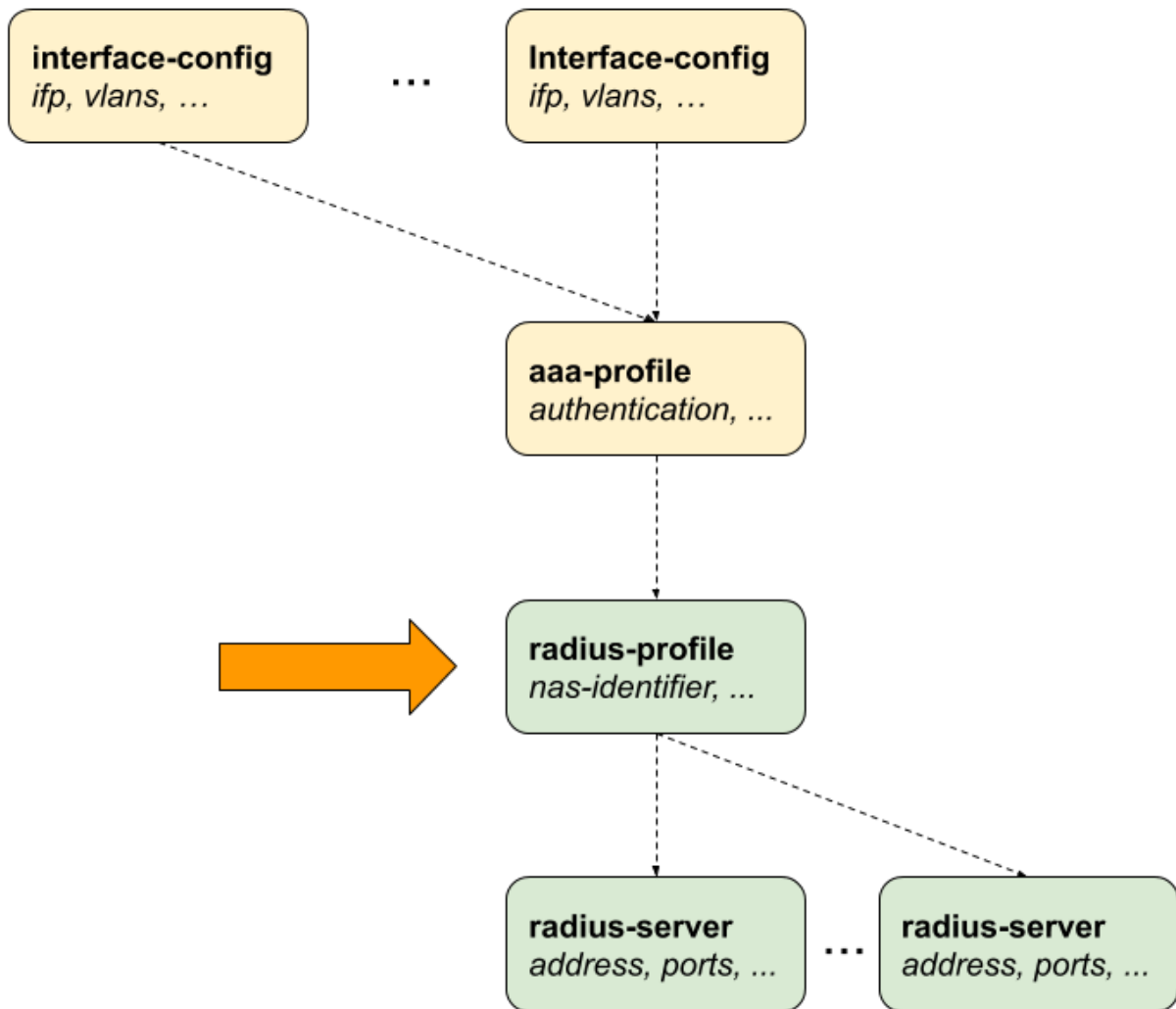

Figure 10. RADIUS Profile Configuration



## Configuring the RADIUS Profile

The RADIUS profile configuration involves setting up various parameters that define how the router interacts with the RADIUS server for authentication, accounting, and so on.

```

supervisor@switch: cfg> set config access radius-profile
  <profile-name>          Name of the RADIUS profile

supervisor@switch: cfg> set config access radius-profile radius-default
  <cr>
  accounting              RADIUS accounting options
  authentication          RADIUS authentication options
  nas-identifier           NAS identifier
  nas-ip-address          NAS IP address (IPv4 Address)
  nas-port-format         NAS-Port format
  nas-port-type           NAS-Port type

```

The following example shows a typical RADIUS profile for authentication and accounting. The RADIUS profile name is specified as 'radius-default'. NAS Identifier is set as BNG and NAS Port Type is specified as 'Ethernet'. RADIUS servers used for authentication is set 'radius-server-1' and 'radius-server-2'. RADIUS servers used for accounting is also set as 'radius-server-1' and 'radius-server-2'.

The Accounting RADIUS servers are specified as 'radius-server-1' 'radius-server-2'. For information about other options, see the table descriptions below.

```

supervisor@switch: cfg> show config access radius-profile radius-default
{
  "rtbrick-config:radius-profile": {
    "profile-name": "radius-default",
    "nas-identifier": "BNG",
    "nas-port-type": "Ethernet",
    "authentication": {
      "radius-server-profile-name": [
        "radius-server-1",
        "radius-server-2"
      ]
    },
    "accounting": {
      "radius-server-profile-name": [
        "radius-server-1",
        "radius-server-2"
      ],
      "stop-on-reject": "true",
      "stop-on-failure": "true",
      "accounting-on-off": "true",
      "accounting-on-wait": "true",
      "accounting-backup": "true",
      "accounting-backup-max": 86400
    }
  }
}

```

```
}

```

Attribute	Description												
nas-identifier	Set the value for the RADIUS attribute NAS-Identifier (32). <b>Default:</b> system hostname												
nas-ip-address	Set the value for RADIUS attribute NAS-IP-Address (4). <b>Default:</b> source IPv4 address												
nas-port-type	Set the value for RADIUS attribute NAS-Port-Type (61). <b>Default:</b> Ethernet												
nas-port-format	Set the format of the 32-bit RADIUS attribute NAS-Port (5). <table border="1" data-bbox="491 846 1410 1108"> <thead> <tr> <th>Name</th> <th>Bits</th> <th>Values</th> </tr> </thead> <tbody> <tr> <td>DEFAULT</td> <td>1:1:6:12:12</td> <td>slot:subslot:port:vlan:vlan</td> </tr> <tr> <td>SLOTS</td> <td>6:2:6:12:6</td> <td>slot:subslot:port:vlan:vlan</td> </tr> <tr> <td>PORTS</td> <td>0:1:7:12:12</td> <td>slot:subslot:port:vlan:vlan</td> </tr> </tbody> </table>	Name	Bits	Values	DEFAULT	1:1:6:12:12	slot:subslot:port:vlan:vlan	SLOTS	6:2:6:12:6	slot:subslot:port:vlan:vlan	PORTS	0:1:7:12:12	slot:subslot:port:vlan:vlan
Name	Bits	Values											
DEFAULT	1:1:6:12:12	slot:subslot:port:vlan:vlan											
SLOTS	6:2:6:12:6	slot:subslot:port:vlan:vlan											
PORTS	0:1:7:12:12	slot:subslot:port:vlan:vlan											

### Configuring Authentication

The following configuration command and options set the 'radius-profile' as authentication method. It also defines the list of RADIUS servers and the algorithm for RADIUS high-availability.

```
supervisor@switch: cfg> set config access radius-profile radius-default
authentication
  <cr>
  algorithm-type           Authentication redundancy algorithm
  radius-server-profile-name RADIUS server profile name
```

Attribute	Description
radius-server-profile-name	List of multiple RADIUS servers used for authentication.
algorithm-type	Specifies the authentication server selection algorithm. For more information, see <a href="#">RADIUS Redundancy</a> . <b>Default:</b> DIRECT <b>Values:</b> DIRECT, ROUND-ROBIN

## Configuring Accounting

Configuring accounting involves specifying its name and defining various parameters.

The following command and options allow you to configure RADIUS accounting.

```

supervisor@switch: cfg> set config access radius-profile radius-default accounting
<cr>
accounting-backup           Enables backup accounting
accounting-backup-max      Maximum backup accounting hold time, in seconds
accounting-on-off          Enables accounting on/off
accounting-on-wait         Wait for an accounting-on response before sending
authentication requests
algorithm-type             Accounting redundancy algorithm
radius-server-profile-name RADIUS server profile name
stop-on-failure            Send accounting-stop on failure
stop-on-reject             Send accounting-stop on authentication reject
    
```

Attribute	Description
radius-server-profile-name	List of RADIUS servers used for accounting.
algorithm-type	Specifies the accounting server selection algorithm. For more information, see <a href="#">RADIUS Redundancy</a> .  <b>Default:</b> DIRECT <b>Values:</b> DIRECT, ROUND-ROBIN
stop-on-failure	If set to <b>true</b> , the accounting will stop, if there is a failure in the process after authentication was accepted.  <b>Default:</b> false
stop-on-reject	If set to <b>true</b> , when the authentication is rejected, the accounting process will stop.  <b>Default:</b> false
accounting-on-off	Enables RADIUS Accounting-On/Off messages. For more information, see <a href="#">RADIUS Accounting</a> .  <b>Default:</b> false

Attribute	Description
accounting-on-wait	<p>Waits for an <b>Accounting-On</b> response ensuring that no new subscriber is allowed until the accounting process has been initiated.</p> <p><b>Default:</b> false</p>
accounting-backup	<p>Enables backup for accounting (optional). RADIUS accounting requests are often used for billing and, therefore should be able to store and retry over a longer period (commonly, up to 24 hours or more).</p> <p><b>Default:</b> false</p>
accounting-backup-max	<p>If enabled, this option defines maximum backup accounting hold time, in seconds.</p> <p><b>Default:</b> 3600 <b>Range:</b> 1 - 4294967295</p>

## RADIUS Server Configuration

Subscriber Management often relies on the RADIUS server for authentication, authorization, and accounting. There are alternative AAA solutions, including local methods that operate independently of network availability.

The RADIUS server configuration is not standalone; it is inherently dependent on the configuration of a RADIUS profile. You must first create a RADIUS profile before configuring the associated RADIUS server.

The following diagram illustrates how RADIUS server configuration fits into the broader context of subscriber management tasks.

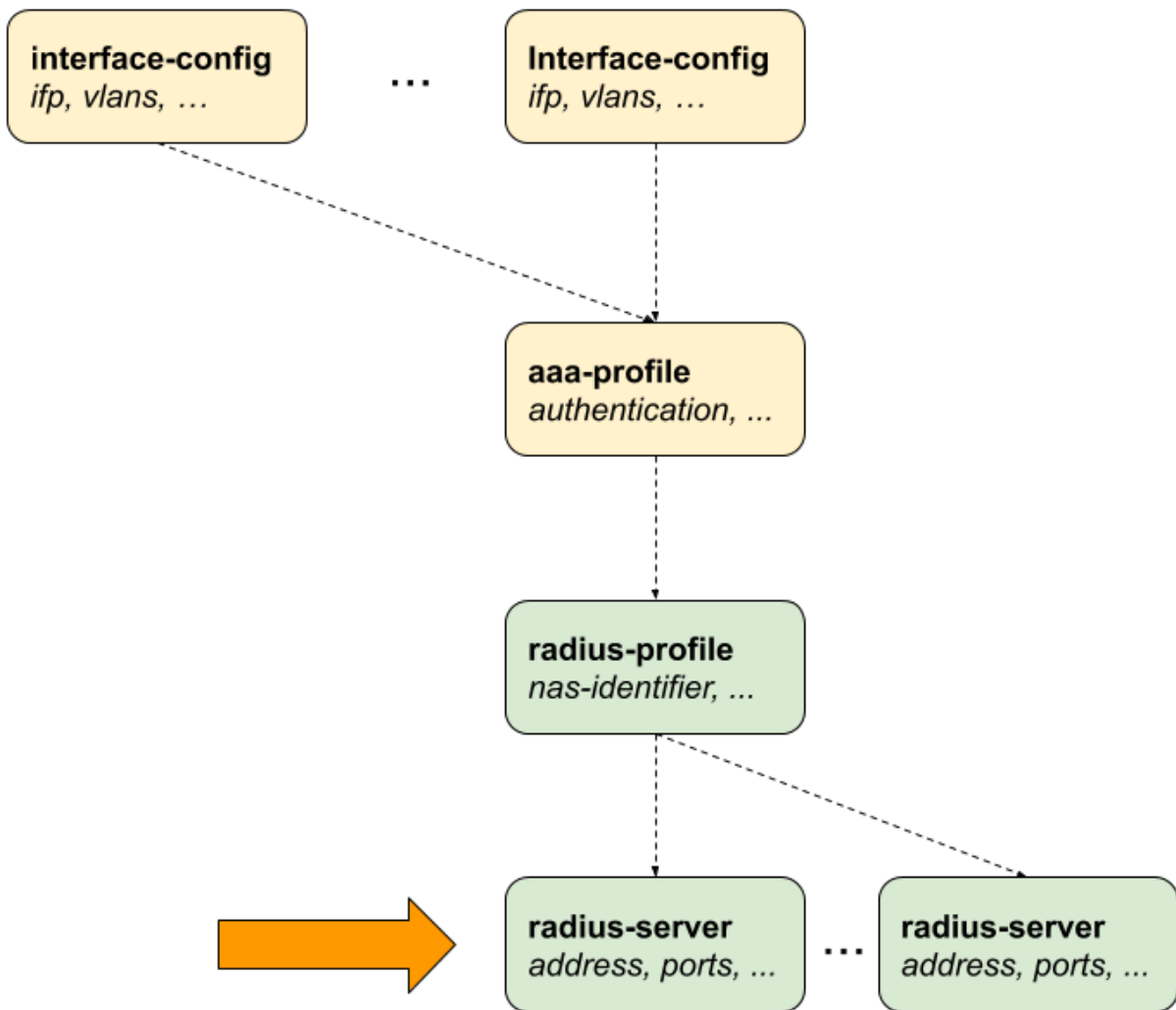

Figure 11. RADIUS Server Configuration

## Configuring the RADIUS Server

The following configuration command and options are used to configure a RADIUS server.

```

supervisor@switch: cfg> set config access radius-server
  <server-name>          Name of the RADIUS server

supervisor@switch: cfg> set config access radius-server radius-server-1
  <cr>
  accounting             RADIUS accounting mode
  address                RADIUS server address
  authentication         RADIUS authentication mode
  coa                    RADIUS Change-of-Authorization (CoA) mode
  rate                  Maximum RADIUS requests per/second
  routing-instance      Instance name
  secret-encrypted-text RADIUS secret in encrypted text
  secret-plain-text     RADIUS secret in plain text
  source-address        Source address used for RADIUS packets
    
```

The following example shows the RADIUS server configuration for authentication and accounting. Each of these options allows you to define how the RADIUS server will operate. The command sets RADIUS server name as 'radius-server-1'. The configuration specifies the IP address '198.51.100.101' of the RADIUS server, which the router will use to send RADIUS requests. The source IP address is specified as '198.51.100.200'. It sets 'CoA' (Change-of-Authorization), a feature that allows the RADIUS server to change the authorization parameters of a session after it has been established.

The **secret-encrypted-text** parameter is specified that configures the RADIUS secret in an encrypted format. The key is used for encrypting RADIUS messages between the client and server to ensure security.

```

supervisor@switch: cfg> show config access radius-server radius-server-1
{
  "rtbrick-config:radius-server": {
    "server-name": "radius-server-1",
    "address": "198.51.100.101",
    "source-address": "198.51.100.200",
    "secret-encrypted-text": "$21e4946e31b406de98b3077aef03ed5a7",
    "authentication": {
      "enable": "true"
    },
    "accounting": {
      "enable": "true"
    },
    "coa": {
      "enable": "true"
    }
  }
}

```

Attribute	Description
address	RADIUS server IPv4 address.  <i>Multiple RADIUS servers with the same IPv4 address are currently not supported, even if the instance or port is different.!</i>
source-address	Local source IPv4 address.
routing-instance	The routing instance in which the RADIUS server is reachable.
secret-encrypted-text	RADIUS secret, which can be provided as plaintext or already encrypted text.
secret-plain-text	

Attribute	Description
rate	Maximum RADIUS requests per second.  <b>Default: 600 Range: 1 - 65535</b>

### Configuring Authentication

The following command and options allow to configure the authentication settings on a RADIUS server. The **enable** option is used to activate RADIUS authentication for the specified RADIUS server 'radius-server-1'. The **outstanding** option allows you to specify the maximum number of pending authentication requests that the device can have at any given time. The **port** option enables you to define the port number used for RADIUS authentication requests. The **retry** option defines the maximum number of retries the device makes if the RADIUS server does not acknowledge an authentication request. This ensures that transient network issues do not cause authentication failures. The **timeout** setting determines the time, in seconds, that the device will wait for a response from the RADIUS server after sending authentication requests. If the server does not respond within this time frame, the request will be considered timed out.

```

supervisor@switch: cfg> set access radius-server radius-server-1 authentication
<cr>
enable                               Enable RADIUS authentication
outstanding                          Maximum number of outstanding authentication requests
port                                  RADIUS server authentication port
retry                                 Maximum retries for authentication request packets
timeout                               Authentication request timeout in seconds
    
```

Attribute	Description
enable	Enables RADIUS authentication.  <b>Default: false</b>
port	RADIUS authentication port.  <b>Default: 1812 Range: 1 - 65535</b>

Attribute	Description
retry	This option specifies the number of authentication retries before declaring this server as unreachable for authentication. After reaching the limit, the client begins to send requests to other RADIUS servers and rejects the request after receiving the end of the list.  <b>Default:</b> 3 <b>Range:</b> 1 - 255
timeout	Authentication request timeout, in seconds.  <b>Default:</b> 5 <b>Range:</b> 1 - 65535
outstanding	This option specifies the maximum number of outstanding authentication requests for this RADIUS server. A request is counted as outstanding if sent out but the response is not received.  <b>Default:</b> 100 <b>Range:</b> 1 - 65535

### Configuring Accounting

RADIUS accounting allows the tracking of user sessions. This configuration sets up RADIUS accounting on a specified RADIUS server.

When enabled, the device will send accounting data to the RADIUS server.

```

supervisor@switch: cfg> set access radius-server radius-server-1 accounting
  <cr>
  enable           Enable RADIUS accounting
  outstanding      Maximum number of outstanding accounting requests
  port            RADIUS server accounting port
  retry           Maximum retries for accounting request packets
  timeout         Accounting request timeout in seconds
    
```

Attribute	Description
enable	Enable RADIUS accounting.  <b>Default:</b> false



Attribute	Description
port	<p>This specifies the port number on the RADIUS server that is used for accounting purpose.</p> <p><b>Default:</b> 1813 <b>Range:</b> 1 - 65535</p>
retry	<p>This option determines the maximum number of attempts the device will make to send an accounting request to the RADIUS server before marking the server as unreachable for accounting. Once the retry limit is reached, the device will attempt to send accounting requests to other configured RADIUS servers.</p> <p><b>Default:</b> 10 <b>Range:</b> 1 - 255</p>
timeout	<p>Accounting request timeout, in seconds.</p> <p><b>Default:</b> 30 <b>Range:</b> 1 - 65535</p>
outstanding	<p>This option specifies the maximum number of outstanding accounting requests for this RADIUS server. A request is counted as outstanding if sent out, but the response is not received.</p> <p><b>Default:</b> 100 <b>Range:</b> 1 - 65535</p>

## Configuring Change-of-Authorization (CoA)

Change-of-Authorization (CoA) allows a RADIUS server to send requests to the network device to change the authorization parameters of an active session. The following configuration involves setting up CoA for a specified RADIUS server called 'radius-server-1'.

```

supervisor@switch: cfg> set access radius-server radius-server-1 coa
  <cr>
  enable           Enable Change-of-Authorization (CoA)
  port            Local RADIUS CoA port

```

Attribute	Description
enable	This option enables the device to receive CoA requests from the specified RADIUS server.  <b>Default:</b> false
port	Specifies the device port that listens/receives for CoA requests from the RADIUS server.  <b>Default:</b> 3799 <b>Range:</b> 1 - 65535

## Service Profile Configuration

You can set up Service Profile to assign specific Quality of Service (QoS) and IGMP settings to individual subscribers. This ensures that each subscriber gets the right level of service based on their requirements. The Service Profile configuration is optional.

The following diagram illustrates how the service profile is associated with other subscriber management tasks.

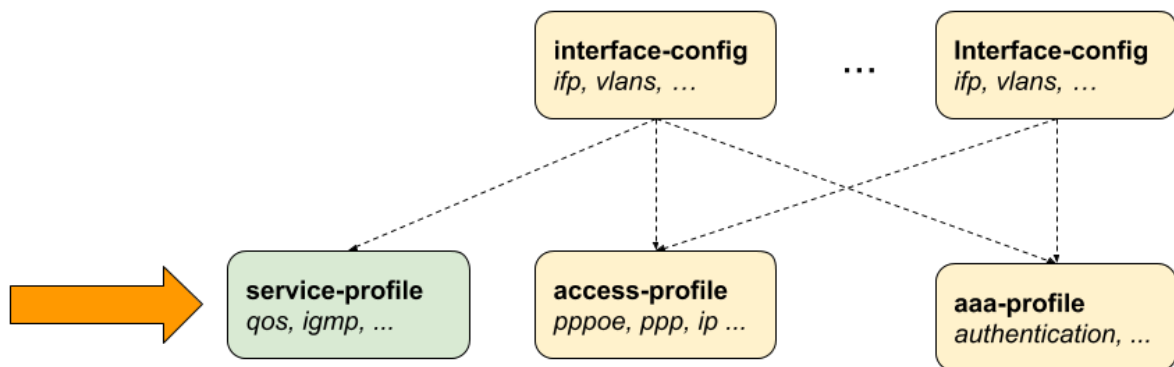

Figure 12. Service Profile Configuration

## Configuring the Service Profile

The following command and options are used to set up a service profile named 'iptv'.

```

supervisor@switch: cfg> set access service-profile
  <profile-name>          Name of the service profile

supervisor@switch: cfg> set access service-profile iptv
  <cr>
    
```

igmp	IGMP related attributes
qos	QoS related attributes

The following example shows a typical service profile configuration for subscribers with IPTV (multicast) services. The configuration defines specific QoS and IGMP settings that will be applied to subscribers using this service profile. In this configuration, the service profile named 'iptv' is linked to a QoS profile named 'iptv-qos-xl'. This QoS profile defines the prioritization and bandwidth allocation for IPTV traffic for the subscriber profile that it is associated with.

Additionally, the configuration specifies the IGMP settings. Enabling IGMP is achieved by setting it to 'true' for the service profile that enables subscribers to join multicast groups. The configuration specifies the IGMP profile named 'iptv-basic', with IGMP version 3 in use. The parameter **max-members** is set to 10, which limits the number of simultaneous multicast groups (maximum IGMP memberships) that a subscriber can join.

```
supervisor@switch: cfg> show config access service-profile iptv
{
  "rtbrick-config:service-profile": {
    "profile-name": "iptv",
    "qos": {
      "profile": "iptv-qos-xl"
    },
    "igmp": {
      "enable": "true",
      "profile": "iptv-basic",
      "version": "IGMPv3",
      "max-members": 10
    }
  }
}
```

## Configuring QoS

The following QoS configuration defines the QoS settings for the service profile 'iptv'.

```
supervisor@switch: cfg> set access service-profile iptv qos
<cr>
parent-scheduler    QoS parent scheduler
profile             QoS profile
```

Attribute	Description
parent-scheduler	<p>This option defines the parent scheduler element within the scheduler-map that is assigned to the subscriber. If the parent scheduler is not specified, the scheduler-map will be directly bound to the local IFP where the session is established.</p> <p>This attribute can only be set once and cannot be changed without disconnecting the session. The parent scheduler can also be configured through RADIUS, which gets priority over the local configuration.</p> <div style="display: flex; align-items: center; margin-top: 20px;">  <div style="border-left: 1px solid black; padding-left: 10px;"> <p>Assigning a QoS parent scheduler that does not exist on the corresponding IFP will result in blackholing all egress data traffic. Control traffic will remain unaffected, allowing the session to persist despite the data loss.</p> </div> </div>
profile	<p>This option assigns a specific QoS configuration profile to the subscriber. The QoS profile can be also set through RADIUS. If configured both locally and through RADIUS, the RADIUS setting gets priority.</p>

## Configuring IGMP

The following IGMP configuration defines the settings for the service profile 'iptv'.

```

supervisor@switch: cfg> set access service-profile iptv igmp
  <cr>
  enable                Enable IGMP service
  max-members           Maximum IGMP membership per subscriber
  profile               IGMP profile
  version               IGMP version
    
```

Attribute	Description
enable	<p>This option dynamically enables or disables IGMP for a subscriber.</p> <p><b>Default:</b> false</p>

Attribute	Description
max-members	This option limits the number of simultaneous multicast channels (maximum IGMP memberships) a subscriber can join.  <b>Default: 1 Range: 1 - 4294967295</b>
profile	This option specifies the IGMP profile to be associated with the subscriber.
version	This defines the version of IGMP for a subscriber.  <b>Default: V3 Values: V1, V2, V3</b>

## L2TP Profile Configuration

The configuration of the Layer 2 Tunnel Protocol (L2TPv2) profile is optional for subscriber management. It is necessary only if you want to enable L2TP tunneling.

The following diagram illustrates how the L2TP profile configuration is associated with the other Subscriber Management tasks.

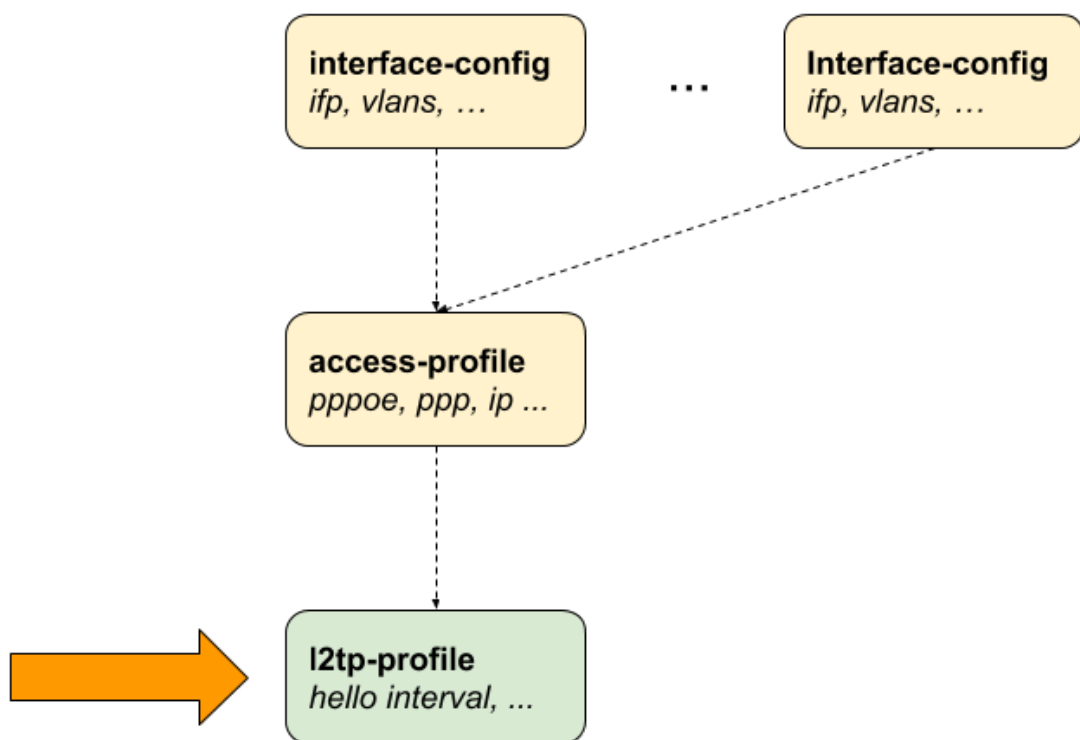

Figure 13. L2TPv2 Profile Configuration

## Configuring the L2TP Profile

The following command and options allow you to configure an L2TP profile.

```
supervisor@switch: cfg> set access l2tp-profile
  <profile-name>          Name of the L2TP profile

supervisor@switch: cfg> set access l2tp-profile l2tp-default
  <cr>
  client-ipv4             Default value for L2TP tunnel client IPv4 address
  client-name             Default value for L2TP tunnel client name
  connect-speed-update    Enable L2TP Connect-Speed-Update-Notification (CSUN)
  dead-timeout-interval   L2TP tunnel dead timeout interval in seconds
  hello-interval          L2TP tunnel hello interval in seconds
  hide-authentication     Hide L2TP tunnel authentication
  idle-timeout-interval   L2TP tunnel idle timeout interval in seconds
  inactive-timeout-interval L2TP tunnel inactive timeout interval in seconds
  instance                Instance name
  pon-access-line-version PON Access Line Information Version
  pool-name               L2TP tunnel pool name
  receive-window          L2TP tunnel receive window
  request-retries         L2TP session request retries
  request-timeout-interval L2TP session request timeout interval in seconds
  retransmit-interval     L2TP tunnel retransmission interval in seconds
  selection-algorithm     L2TP tunnel selection algorithm
  service-label           MPLS service label
  session-limit           L2TP tunnel session limit
```

The following example shows a typical L2TPv2 LAC configuration profile. It outlines a typical L2TPv2 LAC profile, defining essential parameters such as session limits, heartbeat intervals, client identification, and security settings.

This configuration example defines an L2TPv2 LAC (L2TP Access Concentrator) profile named 'l2tp-default'. The **profile-name** is set 'l2tp-default'. This **session-limit** parameter sets the maximum number of sessions that can be established within this L2TP tunnel. The value '4000' indicates that up to 4000 sessions are allowed. The **hello-interval** is set to '60' which indicates the interval (in seconds) for sending 'hello' messages to check the status of the L2TP tunnel.

The **client-name** is specified as 'BNG', which is the name of the client of the L2TP tunnel. The **client-ipv4** is set to '198.51.100.200' which is the 'BNG' IP address. The **hide-authentication** parameter determines whether the authentication credentials for the L2TP tunnel should be hidden. Setting it to **true** indicates the credentials are hidden.

The parameter **service-label** is set to '1234'. It assigns an MPLS service label to the L2TP tunnel. The value '1234' is used as the service label for this tunnel.

```

supervisor@switch: cfg> show config access l2tp-profile l2tp-default
{
  "rtbrick-config:l2tp-profile": {
    "profile-name": "l2tp-default",
    "session-limit": 4000,
    "hello-interval": 60,
    "client-name": "BNG",
    "client-ipv4": "198.51.100.200",
    "hide-authentication": true
    "service-label": 1234
  }
}
    
```

Attribute	Description
client-ipv4	This is the default IPv4 address for the local L2TP tunnel client (LAC), if no specific address is provided through the L2TP pool or RADIUS configuration.
client-name	This is the default hostname for the local L2TP tunnel client (LAC) if no specific hostname is provided through the L2TP pool or RADIUS configuration.  <b>Default:</b> system hostname
instance	The routing instance in which the L2TP endpoint (LNS) is reachable.  <b>Default:</b> default
service-label	Define the service label to support L2TP over MPLS. For more details, see <a href="#">Configuring L2TP over MPLS</a> . Supported MPLS label values range from 0 to 1048575. The reserved MPLS label range is 0 - 15. In RBFS, BGP uses the label range 20000 - 100000. To avoid conflicts, it is recommended to assign label values outside of these reserved ranges.
selection-algorithm	It defines how to select a tunnel from a pool of available LNS servers. For more information, see <a href="#">L2TP Tunnel Selection</a> .  The RANDOM algorithm selects a tunnel randomly, while the BALANCED algorithm chooses the tunnel with the fewest sessions.  <b>Default::</b> BALANCED <b>Values:</b> BALANCED, RANDOM

Attribute	Description
session-limit	<p>This is the default session limit for a tunnel unless otherwise specified. Tunnels that have reached their session limit are not considered for additional sessions.</p> <p><b>Default:</b> 64000 <b>Range:</b> 1 - 65535</p>
pool-name	<p>This allows to assign a default L2TP tunnel pool. For more information, see <a href="#">L2TP Tunnel Pool Configuration</a>. This default can be overwritten by user-defined pool names from the local user profiles (For more information, see <a href="#">User Profile Configuration</a>) or received through RADIUS attribute RtBrick-L2TP-Pool (VSA 26-50058-40).</p>
hello-interval	<p>Specifies the L2TP tunnel hello interval time, in seconds. '0' indicates disabled.</p> <p>The HELLO keep-alive messages are part of the L2TP control channel. For more information, see <a href="#">L2TP Control Channel</a>. These messages are sent only when the message queue is empty, and no other messages have been transmitted during the hello interval.</p> <p><b>Default:</b> 30 <b>Range:</b> 0 - 86400</p>
idle-timeout-interval	<p>This interval defines the maximum time, in seconds, to keep a tunnel without sessions established. The session will remain forever if this value is set to 0.</p> <p><b>Default:</b> 600 <b>Range:</b> 0 - 4294966</p>
dead-timeout-interval	<p>This interval defines the time, in seconds, that a tunnel remains in the DEAD state if it becomes unreachable. Once the interval expires, the tunnel transitions back to the DOWN state, making it available for new sessions.</p> <p><b>Default:</b> 300 <b>Range:</b> 1 - 4294966</p>



Attribute	Description
inactive-timeout-interval	<p>This interval defines the time, in seconds, to keep an inactive tunnel before removal. This interval is reset with every new session request which considers this tunnel as a potential candidate.</p> <p><b>Default:</b> 900 <b>Range:</b> 1 - 4294966</p>
receive-window	<p>Specifies the receive window size offered to the remote peer through the Receive Window Size AVP (10) in SCCRQ or SCCRP message.</p> <p>For example, if a receive window size of '8' is advertised in the SCCRQ or SCCRP message, the remote peer can send up to 8 unacknowledged control messages. After reaching this limit, it must wait for an acknowledgment to advance the window before sending additional messages.</p> <p><b>Default:</b> 8 <b>Range:</b> 1 - 256</p>
request-retries	<p>Defines the number of times the system attempts to establish a tunnel before considering it unsuccessful. See also the `request-timeout-interval` attribute.</p> <p><b>Default:</b> 5 <b>Range:</b> 1 - 600</p>
request-timeout-interval	<p>This interval, when multiplied by the number of request retries, determines the maximum time (in seconds) to wait for the selected tunnel to establish before selecting to another tunnel from the list.</p> <p><b>Default:</b> 1 <b>Range:</b> 1 - 30</p> <div style="display: flex; align-items: center; margin-top: 10px;">  <div style="border-left: 1px solid black; padding-left: 10px;"> <p>Modify the values for <b>request-retries</b> and <b>request-timeout-interval</b> attributes with caution, as incorrect value may lead to delay in tunnel establishment.</p> </div> </div>

Attribute	Description
retransmit-interval	<p>This value specifies the interval, in seconds, between retransmissions of a message.</p> <p>Each successive retransmission uses an exponential backoff interval, meaning the interval doubles after each retransmission. For example, if the first retransmission occurs after 1 second, the next will occur after 2 seconds, then 4 seconds, 8 seconds, 16 seconds, 32 seconds, and finally 64 seconds. After a maximum of 6 retransmissions, the interval reaches its maximum value. For a retransmit interval of 1, the total time can reach 64 seconds, and for an interval of 2, it can extend up to 128 seconds and so on.</p> <p><b>Default:</b> 1 <b>Range:</b> 1 - 30</p>
hide-authentication	<p>When enabled, the L2TP proxy will hide the authentication response AVP if the authentication type is PAP, ensuring that the password is not transmitted in plain text.</p> <p><b>Default:</b> false</p>
pon-access-line-version	<p>Adding additional PON attributes to the L2TP access line information. (For more information, see <a href="#">L2TP Access Line Information (RFC5515)</a>) as defined in <a href="#">draft-lihawi-ancp-protocol-access-extension</a> which can be optionally enabled using this configuration attribute.</p> <div style="display: flex; align-items: center; margin-top: 10px;">  <div style="border-left: 1px solid black; padding-left: 10px;"> <p>RFC and draft compliance are partial except as specified.</p> </div> </div> <p>The value DRAFT-LIHAWI-00 enables PON attributes based on the definition in <a href="#">draft-lihawi-ancp-protocol-access-extension-00</a> whereas DRAFT-LIHAWI-04 uses <a href="#">draft-lihawi-ancp-protocol-access-extension-04</a>.</p> <p><b>Default::</b> DISABLED <b>Values:</b> DRAFT-LIHAWI-00, DRAFT-LIHAWI-04</p>

Attribute	Description
connect-speed-update	<p>Enable <b>L2TP Connect-Speed-Update-Notification (CSUN)</b> requests as defined in RFC5515. For more information, see <b>Connect-Speed-Update-Notification (CSUN)</b>.</p> <p>CSUN is an L2TP control message sent by the LAC to the LNS to provide updates on transmit and receive connection speeds for one or more sessions. By default, this feature is disabled but can be enabled using this configuration.</p> <p><b>Default:</b> false</p>

## Configuring L2TP over MPLS

L2TP over MPLS requires a dedicated L2TP service label which must be defined manually. First, you must assign a specific MPLS label for L2TP services. This is done in the L2TP profile configuration. Next, you must configure BGP to advertise this label. This involves configuring a routing policy that specifies how to handle the L2TP service label in BGP updates.

Following is an example command for L2TP configuration with L2TP service label.

```
set access l2tp-profile l2tp-default service-label 1234
```

Advertising this label through BGP must be configured manually as shown in the following example. The exact policy configuration depends on the actual network and existing policy concept.

In the following configuration, the policy named L2TP\_MPLS contains rules for traffic related to L2TP over MPLS. The policy consists of multiple rules, each specifying conditions for matching traffic and actions to take.

In the 'Ordinal 1' match rule, it specifies the **Type** as 'ipv4-prefix', **Value-Type** as 'discrete', **Match-Type** as 'exact' and **Value** is set to '198.51.100.200/24'. This rule matches traffic that has an exact IPv4 prefix of 198.51.100.200/24.

In the Action Rule, it specifies **Type** as 'label', **Operation** as 'overwrite' and **Value: label** is set to '1337,bos:1'. If the traffic matches the IPv4 prefix, the action overwrites the MPLS label with '1337' and sets the BOS bit to '1'.

In the 'Ordinal 2', it defines the action rule. After applying the label overwrite action in 'Ordinal 1', this rule permits the traffic to continue through the network with the updated label.

```
supervisor@switch: cfg> show config policy
{
  "rtbrick-config:policy": {
    "statement": [
      {
        "name": "L2TP_MPLS",
        "ordinal": [
          {
            "ordinal": 1,
            "match": {
              "rule": [
                {
                  "rule": 1,
                  "type": "ipv4-prefix",
                  "value-type": "discrete",
                  "match-type": "exact",
                  "value": "198.51.100.200/24"
                }
              ]
            },
            "action": {
              "rule": [
                {
                  "rule": 1,
                  "type": "label",
                  "operation": "overwrite",
                  "value": "label:1337,bos:1"
                }
              ]
            }
          },
          {
            "ordinal": 2,
            "action": {
              "rule": [
                {
                  "rule": 1,
                  "operation": "return-permit"
                }
              ]
            }
          }
        ]
      }
    ]
  }
}
```

In the following configuration, the instance name is set as 'internet' and the Address Family is specified as 'ipv4 and unicast'. The export policy is set to L2TP\_MPLS, indicating that the label defined in the L2TP\_MPLS policy will be

advertised for this instance.

```

supervisor@switch: cfg> show config instance internet
{
  "rtbrick-config:instance": {
    "name": "internet",
    "address-family": [
      {
        "afi": "ipv4",
        "safi": "unicast",
        "policy": {
          "export": "L2TP_MPLS"
        }
      }
    ]
  }
}

```

## L2TP Tunnel Pool Configuration

The configuration of the Layer 2 Tunnel Protocol (L2TPv2) pool is optional for subscriber management. It is necessary only if you want to enable L2TP tunneling.

The L2TP pool configuration helps to efficiently organize and manage multiple LNS servers. It allows you to define these sets locally to ensure that L2TP tunnels are directed to the appropriate servers.

### Configuring the L2TP Tunnel Pool

The following command and options allow you to configure an L2TP tunnel pool.

```

supervisor@switch: cfg> set access l2tp-pool
  <pool-name>          Name of the L2TP pool

supervisor@switch: cfg> set access l2tp-pool lns-servers
  <client-name>       L2TP client (LAC) name

supervisor@switch: cfg> set access l2tp-pool lns-servers BNG
  <server-name>      L2TP server (LNS) name

supervisor@switch: cfg> set access l2tp-pool lns-servers BNG LNS
  <cr>
  client-ipv4         L2TP client (LAC) IPv4
  preference          Preference
  secret-encrypted-text  Shared secret in encrypted text
  secret-plain-text   Shared secret in plain text
  server-ipv4         L2PTP server (LNS) IPv4
  session-limit       Session limit

```

The following example shows a local pool with two LNS servers.

This configuration sets an L2TP pool named 'lns-pool-example' with two LNS servers (LNS1 and LNS2). It defines how the device will manage L2TP tunnels. In this example, there are two different LNS server entries for two different LNS servers, LNS1 and LNS2. Both entries belong to the same pool named 'lns-pool-example'. Each entry in the `l2tp-pool` array defines the configuration for an individual LNS server.

The `client-name` is specified as BNG, which indicates that the client will initiate L2TP tunnels to the listed LNS servers. The `server-name` specifies the name of the LNS. Each entry has a unique server name, LNS1 for the first entry and LNS2 for the second.

The `client-ipv4` specifies the IPv4 address of the L2TP client, that is BNG. In both entries, the LAC's IP address is '198.51.100.200'. The `server-ipv4` specifies the IPv4 address of the LNS. The first entry has '198.51.100.219' for LNS1, and the second entry has '198.51.100.220' for LNS2.

The `secret-encrypted-text` parameter specifies the shared secret used for authenticating the L2TP tunnel between the LAC and LNS. The value is encrypted, and the secret is the same in both entries: '\$21e4946e31b406de98b3077aef03ed5a7'.

The `preference` parameter sets the preference value for the LNS server. A lower value generally indicates a higher preference, but in this case, both entries have the same preference value of 1000. The `session-limit` parameter specifies the maximum number of sessions (L2TP tunnels) that can be established with the LNS server. Both entries have a session limit of 1000.

```
supervisor@switch: cfg> show config access
{
  "rtbrick-config:access": {
    "l2tp-pool": [
      {
        "pool-name": "lns-pool-example",
        "client-name": "BNG",
        "server-name": "LNS1",
        "client-ipv4": "198.51.100.200",
        "server-ipv4": "198.51.100.219",
        "secret-encrypted-text": "$21e4946e31b406de98b3077aef03ed5a7",
        "preference": 1000,
        "session-limit": 1000
      },
      {
        "pool-name": "lns-pool-example",
        "client-name": "BNG",
        "server-name": "LNS2",
```

```

        "client-ipv4": "198.51.100.200",
        "server-ipv4": "198.51.100.220",
        "secret-encrypted-text": "$21e4946e31b406de98b3077aef03ed5a7",
        "preference": 1000,
        "session-limit": 1000
    }
}
}
}

```

Attribute	Description
client-name	Local L2TP tunnel client (LAC) hostname.
server-name	Remote L2TP tunnel server (LNS) hostname.
client-ipv4	Local L2TP tunnel client (LAC) IPv4 address.
server-ipv4	Remote L2TP tunnel server (LNS) IPv4 address.
secret-encrypted-text	L2TP tunnel secret, which can be provided as plaintext or already encrypted text.
secret-plain-text	
preference	L2TP tunnel preference where the lowest value has the highest priority.  <b>Default: 0 Range: 1 - 65535</b>
session-limit	Tunnels with a session limit reached are not considered for further sessions. This limit has precedence over the default session limit specified in the <a href="#">l2tp-profile</a> .  <b>Default: 64000 Range: 1 - 65535</b>

## User Profile Configuration

Subscribers are usually authenticated through remote servers like RADIUS. However, RBFS also provides the option to authenticate sessions by comparing them against user profiles that are locally defined within the system.

### Configuring the User Profile

The following command and options are used to configure a user profile. A user profile also includes authentication details.

```

supervisor@switch: cfg> set access user-profile
<user-name>          Username

supervisor@switch: cfg> set access user-profile user@rtbrick.com
<cr>
l2tp-pool-name       L2TP pool name
password-encrypted-text Secret/password in encrypted text
password-plain-text  Secret/password in plain text
tunnel-type          Tunnel type
    
```

The following configuration shows the user name specified as 'user@rtbrick.com'. The **password-encrypted-text** attribute enables you to set the user's password in an encrypted format. The **tunnel-type** is set to PPPoE.

```

supervisor@switch: cfg> show config access user-profile user@rtbrick.com
{
  "rtbrick-config:user-profile": {
    "user-name": "user@rtbrick.com",
    "password-encrypted-text": "$243a1341f44f54888cdd385b9f40513f1",
    "tunnel-type": "PPPoE"
  }
}
    
```

Attribute	Description
user-name	Username of the subscriber.
password-encrypted-text	User password which can be provided as plaintext or already encrypted text.
password-plain-text	
tunnel-type	Subscriber tunnel type.  <b>Default:</b> PPPoE <b>Values:</b> PPPoE, L2TP
l2tp-pool-name	Assign a local configured L2TP tunnel pool.

## IP Address Pool Configuration

IP address pools are crucial for assigning IP addresses to subscribers, and configuring these pools is an essential for subscriber management.

The following image illustrates the IP address pool configuration and how they are associated with the other subscriber management tasks.



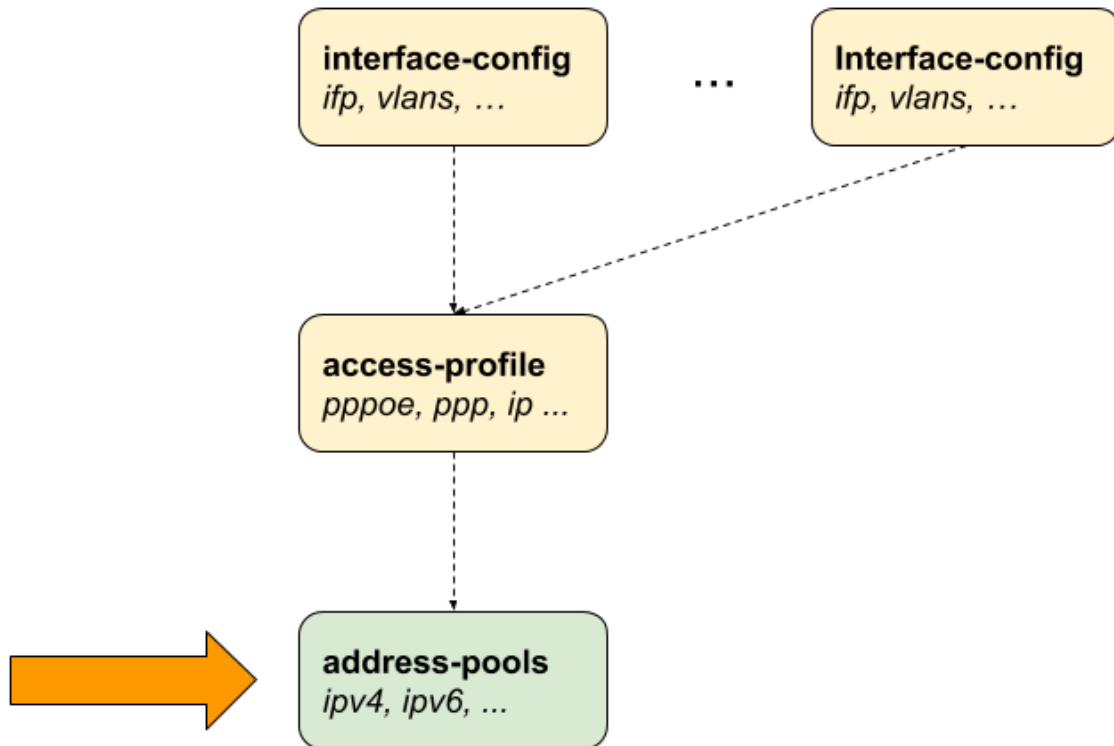

Figure 14. IP Address Pool Configuration

### About RBFS IP Address Pool

RBFS allows you to manage address pools with more flexibility. It enables you to modify or remove pools without disrupting active subscriber sessions. If an address pool is deleted, subscribers who have already been assigned IP addresses from that pool can continue using those addresses until their session ends. The system does not immediately revoke the IP addresses assigned to active sessions.

Imagine a subscriber has been allocated an IP address from a specific address pool. If that pool is later deleted, the subscriber's connection remains unaffected until their session ends.



Ensure that the deleted address pool is not reallocated elsewhere until all assigned addresses are no longer in use. This prevents IP address conflicts.

### Duplicate Address Detection

RBFS provides an optional duplicate address detection feature that prevents a new session from using an IP address already in use by another active session. This is to avoid conflicts. However, when an address pool is moved to a different BNG, the

duplicate address detection feature may not work as expected.



Migrating address pools across different BNGs could lead to address conflicts, if not managed carefully.

## Configuring the Address Pool

The following command and options allows you to configure both IPv4 and IPv6 address pools for subscriber access.

```

set access pool
<pool-name>          Name of the address pool

supervisor@switch: cfg> set access pool ipv4-local
<cr>
ipv4-address          IPv4 address pool configuration
ipv6-prefix           IPv6 prefix pool configuration
next-pool-name        Name of the next address pool to be used if full

```

The following example shows typical IPv4 address and IPv6 prefix pools. It shows three pools: one for IPv4 addresses and two for IPv6 prefixes. Each pool is defined by a name, and a range of addresses or prefixes is specified using the 'low' and 'high' values. These pools are used for dynamically assigning IP addresses or prefixes to devices or subscribers, depending on the protocol (IPv4 or IPv6).

The IPv4 address pool, named 'ipv4-local', includes the address range from '198.51.100.76' to '198.51.100.117'. This pool defines a range of IPv4 addresses from 198.51.100.76 to 198.51.100.117. These addresses can be dynamically assigned to devices or subscribers that require IPv4 connectivity.

The specified second pool is 'ipv6-local' that defines a range of IPv6 prefixes, from '2001:db8:0:79::/32' to '2001:db8:0:139::/32'. These prefixes can be assigned to devices or subscribers that require IPv6 connectivity.

The IPv6 Prefix Delegation Pool is specified as 'ipv6pd-local'. It defines the range of IPv6 from 2001:db8:0:1::/32 to '2001:db8:0:100::/32'. This pool is similar to the previous IPv6 pool, but is specifically meant for IPv6 Prefix Delegation.

```

supervisor@switch: cfg> show config access
{
  "rtbrick-config:access": {
    "pool": [
      {
        "pool-name": "ipv4-local",
        "ipv4-address": {

```

```

        "low": "198.51.100.76",
        "high": "198.51.100.117"
    },
    {
        "pool-name": "ipv6-local",
        "ipv6-prefix": {
            "low": "2001:db8:0:79::/32",
            "high": "2001:db8:0:139::/32"
        }
    },
    {
        "pool-name": "ipv6pd-local",
        "ipv6-prefix": {
            "low": "2001:db8:0:1::/32",
            "high": "2001:db8:0:100::/32"
        }
    }
],
}
}

```

## Configuring IPv4 Address Pools

The following command and options allow you to configure an IPv4 address pool.

```

supervisor@switch: cfg> set access pool ipv4-local ipv4-address
<cr>
high                Highest IPv4 address
low                 Lowest IPv4 address
subnet-mask         Subnet mask

```

Attribute	Description
high	Highest IPv4 address.
low	Lowest IPv4 address.
subnet-mask	subnet mask allocated to the subscriber.

## Configuring IPv6 Prefix Pools

The following command and options allow you to configure an IPv6 prefix pools.

```

supervisor@switch: cfg> set access pool ipv6-local ipv6-prefix
<cr>
high                Highest IPv6 prefix
low                 Lowest IPv6 prefix

```

Attribute	Description
high	Highest IPv6 prefix.
low	Lowest IPv6 prefix.



IPv6 prefixes must be at least /64 or larger (/56, /48, ...) or /128.

## Configuring Linked Pools

RBFS enables pool linking. You can link multiple IP address pools so that when a pool gets exhausted, the next pool defined will start address allocation. Pool linking allows the creation of discontinuous address pools connected together in a sequence, creating an extended pool. The pools are connected using the **next-pool-name** attribute.

A - B - C - D

```
supervisor@switch: cfg> set access pool pool-A next-pool pool-B
supervisor@switch: cfg> set access pool pool-B next-pool pool-C
supervisor@switch: cfg> set access pool pool-C next-pool pool-D
```

The actual address pool assigned to a subscriber is determined by the access configuration profile or RADIUS, starting with the specified pool in the chain. If that pool is full, the system requests the next pool in sequence, continuing until an available pool is found or the end of the chain is reached. To prevent looping, RBFS halts automatically if it detects that any pool in the chain has been accessed twice.

Additionally, the system can continuously cycle through all available pools in the chain, even if allocation starts from a pool in the middle. This ensures every pool in the sequence gets considered till finding an available address.

The following configuration commands link a set of IP address pools in a cycle order. The 'pool-A' is linked with the 'pool-B', 'pool-C' is set as a next pool after the 'pool-B'. 'Pool-D' is specified as next pool for 'pool-C'. 'Pool-A' is set as the next pool for 'pool-A'.

A - B - C - D - A

```
supervisor@switch: cfg> set access pool pool-A next-pool pool-B
supervisor@switch: cfg> set access pool pool-B next-pool pool-C
supervisor@switch: cfg> set access pool pool-C next-pool pool-D
supervisor@switch: cfg> set access pool pool-D next-pool pool-A
```

## Control Plane Outbound Marking Configuration

The Control Plane Outbound Marking involves marking control plane packets as they exit the network device. This marking helps ensure that the packets are handled according to specific policies.

The process of marking all outbound control plane packets is established through the configuration settings within the **forwarding-options**, which are illustrated in the following example.

By employing these settings, network operators can ensure that control plane traffic is appropriately identified and treated according to specified criteria, contributing to an optimized and well-orchestrated network environment.

The following configuration shows the outbound control plane packets are marked with specific attributes, such as priority or type of service, making it easier to identify them within the network.

The configuration specifies how outbound control plane packets are marked based on their protocol under the **forwarding-options**. The class of service, is to set Control Plane QoS which ensures that the control traffic is marked and treated with priority. The **outbound-marking** defines how control plane traffic is marked. **Protocol** and **Remark Types** settings specify three protocols: L2TPv2, PPP, and RADIUS.

Each protocol is marked with different settings:

- The L2TPv2 packets are marked with a ToS codepoint of 64, which influences how routers handle these packets.
- The PPP packets are marked using a p-bit (priority bit) of 6, which indicates priority.
- Similar to L2TPv2, RADIUS packets are marked with a ToS codepoint of 64 for priority.

```
supervisor@switch: cfg> show config forwarding-options
{
  "rtbrick-config:forwarding-options": {
    "class-of-service": {
      "control-plane-qos": {
        "outbound-marking": {
          "protocol": [
            {
              "protocol": "l2tpv2",
```

```

        "remark-type": "tos",
        "codepoint": 64
      },
      {
        "protocol": "ppp",
        "remark-type": "p-bit",
        "codepoint": 6
      },
      {
        "protocol": "radius",
        "remark-type": "tos",
        "codepoint": 64
      }
    ]
  }
}
}

```

## Configuration Examples

### PPPoE

The following example shows a PPPoE configuration for VLAN mode 1:1 with IPv4 and IPv6 enabled, authenticated via RADIUS.

```

{
  "ietf-restconf:data": {
    "rtbrick-config:access": {
      "aaa-profile": [
        {
          "profile-name": "aaa-radius",
          "session-timeout": 0,
          "idle-timeout": 0,
          "aaa-radius-profile": "radius-default",
          "authentication": {
            "order": "RADIUS"
          },
          "accounting": {
            "order": "RADIUS",
          }
        }
      ],
      "radius-profile": [
        {
          "profile-name": "radius-default",
          "nas-identifier": "BNG",
          "nas-port-type": "Ethernet",
          "authentication": {
            "radius-server-profile-name": [
              "radius-server-1",
              "radius-server-2"
            ]
          },
          "accounting": {

```

```

    "radius-server-profile-name": [
      "radius-server-1",
      "radius-server-2"
    ],
    "stop-on-reject": "true",
    "stop-on-failure": "true",
    "accounting-on-off": "true",
    "accounting-on-wait": "true",
    "accounting-backup": "true",
    "accounting-backup-max": 86400
  }
},
"radius-server": [
  {
    "server-name": "radius-server-1",
    "address": "198.51.100.101",
    "source-address": "198.51.100.200",
    "secret-encrypted-text": "$21e4946e31b406de98b3077aef03ed5a7",
    "authentication": {
      "enable": "true"
    },
    "accounting": {
      "enable": "true"
    },
    "coa": {
      "enable": "true"
    }
  },
  {
    "server-name": "radius-server-2",
    "address": "198.51.100.102",
    "source-address": "198.51.100.200",
    "secret-encrypted-text": "$21e4946e31b406de98b3077aef03ed5a7",
    "authentication": {
      "enable": "true"
    },
    "accounting": {
      "enable": "true"
    },
    "coa": {
      "enable": "true"
    }
  }
],
"access-profile": [
  {
    "profile-name": "pppoe-dual",
    "protocol": {
      "pppoe": {
        "enable": "true",
        "session-protection": {
          "enable": "true"
        }
      },
      "vlan-priority": 6
    },
    "ppp": {
      "lcp": {
        "authentication-protocol": "PAP_CHAP",
        "echo-interval": 30,
        "echo-max-retransmit": 3,

```

```
        "echo-enable": "true"
      },
      "ipcp": {
        "enable": "true",
        "source-if1": "lo-0/0/0/1"
      },
      "ip6cp": {
        "enable": "true"
      }
    },
    "ra": {
      "enable": "true",
      "interval": 60
    },
    "dhcpv6": {
      "enable": "true"
    },
    "l2tp": {
      "tunnel-profile": "l2tp-default"
    }
  },
  "address-family": {
    "ipv4": {
      "enable": "true",
      "primary-dns": "198.51.100.103",
      "secondary-dns": "198.51.100.104",
      "instance": "default"
    },
    "ipv6": {
      "enable": "true",
      "primary-dns": "2001:db8:0:100::",
      "secondary-dns": "2001:db8:0:104::",
      "instance": "default"
    }
  }
},
],
"interface": {
  "double-tagged": [
    {
      "interface-name": "if1-0/0/1",
      "outer-vlan-min": 1,
      "outer-vlan-max": 4094,
      "inner-vlan-min": 7,
      "inner-vlan-max": 7,
      "access-type": "PPPoE",
      "access-profile-name": "pppoe-dual",
      "aaa-profile-name": "aaa-radius"
    }
  ]
},
"l2tp-profile": [
  {
    "profile-name": "l2tp-default",
    "session-limit": 4000,
    "client-name": "BNG",
    "client-ipv4": "198.51.100.200",
    "hide-authentication": true
  }
]
},
```



```

"rtbrick-config:interface": [
  {
    "name": "ifl-0/0/1",
    "description": "Access",
    "host-if": "eth0"
  },
  {
    "name": "ifl-0/0/2",
    "description": "Core",
    "host-if": "eth1",
    "unit": [
      {
        "unit-id": 1,
        "address": {
          "ipv4": [
            {
              "prefix4": "198.51.100.33/24"
            }
          ],
          "ipv6": [
            {
              "prefix6": "2001:db8:0:32::/32"
            }
          ]
        }
      }
    ]
  },
  {
    "name": "lo-0/0/0",
    "unit": [
      {
        "unit-id": 1,
        "address": {
          "ipv4": [
            {
              "prefix4": "198.51.100.200/24"
            }
          ]
        }
      }
    ]
  }
]
}

```

## IPoE

The following example shows an IPoE configuration for VLAN mode 1:1 with IPv4 and IPv6 enabled, authenticated via RADIUS.

```

{
  "ietf-restconf:data": {
    "rtbrick-config:access": {
      "aaa-profile": [
        {

```

```
"profile-name": "aaa-radius",
"session-timeout": 0,
"idle-timeout": 0,
"aaa-radius-profile": "radius-default",
"authentication": {
  "order": "RADIUS"
},
"accounting": {
  "order": "RADIUS",
}
}
],
"radius-profile": [
{
"profile-name": "radius-default",
"nas-identifier": "BNG",
"nas-port-type": "Ethernet",
"authentication": {
  "radius-server-profile-name": [
    "radius-server-1",
    "radius-server-2"
  ]
},
"accounting": {
  "radius-server-profile-name": [
    "radius-server-1",
    "radius-server-2"
  ],
  "stop-on-reject": "true",
  "stop-on-failure": "true",
  "accounting-on-off": "true",
  "accounting-on-wait": "true",
  "accounting-backup": "true",
  "accounting-backup-max": 86400
}
}
],
"radius-server": [
{
"server-name": "radius-server-1",
"address": "198.51.100.101",
"source-address": "198.51.100.200",
"secret-encrypted-text": "$21e4946e31b406de98b3077aef03ed5a7",
"authentication": {
  "enable": "true"
},
"accounting": {
  "enable": "true"
},
"coa": {
  "enable": "true"
}
},
{
"server-name": "radius-server-2",
"address": "198.51.100.102",
"source-address": "198.51.100.200",
"secret-encrypted-text": "$21e4946e31b406de98b3077aef03ed5a7",
"authentication": {
  "enable": "true"
},
}
```

```

    "accounting": {
      "enable": "true"
    },
    "coa": {
      "enable": "true"
    }
  }
],
"access-profile": [
  {
    "profile-name": "ipoe-dual",
    "protocol": {
      "dhcp": {
        "enable": "true",
        "mode": "server"
      },
      "dhcpv6": {
        "enable": "true",
        "mode": "server"
      },
    },
    "address-family": {
      "ipv4": {
        "enable": "true",
        "pool-name": "ipoe",
        "primary-dns": "198.51.100.103",
        "secondary-dns": "198.51.100.104",
        "instance": "default"
      },
      "ipv6": {
        "enable": "true",
        "pool-name": "ipoe-ia-na",
        "prefix-delegation-pool-name": "ipoe-ia-pd",
        "primary-dns": "2001:db8:0:100::",
        "secondary-dns": "2001:db8:0:104::",
        "instance": "default"
      }
    }
  }
],
"interface": {
  "double-tagged": [
    {
      "interface-name": "ifl-0/0/1",
      "outer-vlan-min": 1,
      "outer-vlan-max": 4094,
      "inner-vlan-min": 7,
      "inner-vlan-max": 7,
      "access-type": "IPoE",
      "access-profile-name": "ipoe-dual",
      "aaa-profile-name": "aaa-radius",
      "gateway-ifl": "lo-0/0/0/1"
    }
  ]
},
"pool": [
  {
    "pool-name": "ipoe",
    "ipv4-address": {
      "low": "10.0.0.1",
      "high": "10.0.255.255"
    }
  }
]

```

```
    }
  },
  {
    "pool-name": "ipoe-ia-na",
    "ipv6-prefix": {
      "low": "fc66::1/128",
      "high": "fc66::ffff/128"
    }
  },
  {
    "pool-name": "ipoe-ia-pd",
    "ipv6-prefix": {
      "low": "fc66:0:100::/56",
      "high": "fc66:0:1ff:ff00::/56"
    }
  }
],
},
"rtbrick-config:interface": [
  {
    "name": "ifl-0/0/1",
    "description": "Access",
    "host-if": "eth0"
  },
  {
    "name": "ifl-0/0/2",
    "description": "Core",
    "host-if": "eth1",
    "unit": [
      {
        "unit-id": 1,
        "address": {
          "ipv4": [
            {
              "prefix4": "198.51.100.33/24"
            }
          ],
          "ipv6": [
            {
              "prefix6": "2001:db8:0:6423::/32"
            }
          ]
        }
      }
    ]
  }
],
},
{
  "name": "lo-0/0/0",
  "unit": [
    {
      "unit-id": 1,
      "address": {
        "ipv4": [
          {
            "prefix4": "198.51.100.200/24"
          }
        ]
      }
    }
  ]
}
]
```

```

    ]
  }
}

```

### 5.1.3. Operations

#### Subscriber Management

The following commands are served by subscriber daemon and are applicable for all kinds of subscribers like PPPoE, L2TP or IPoE.

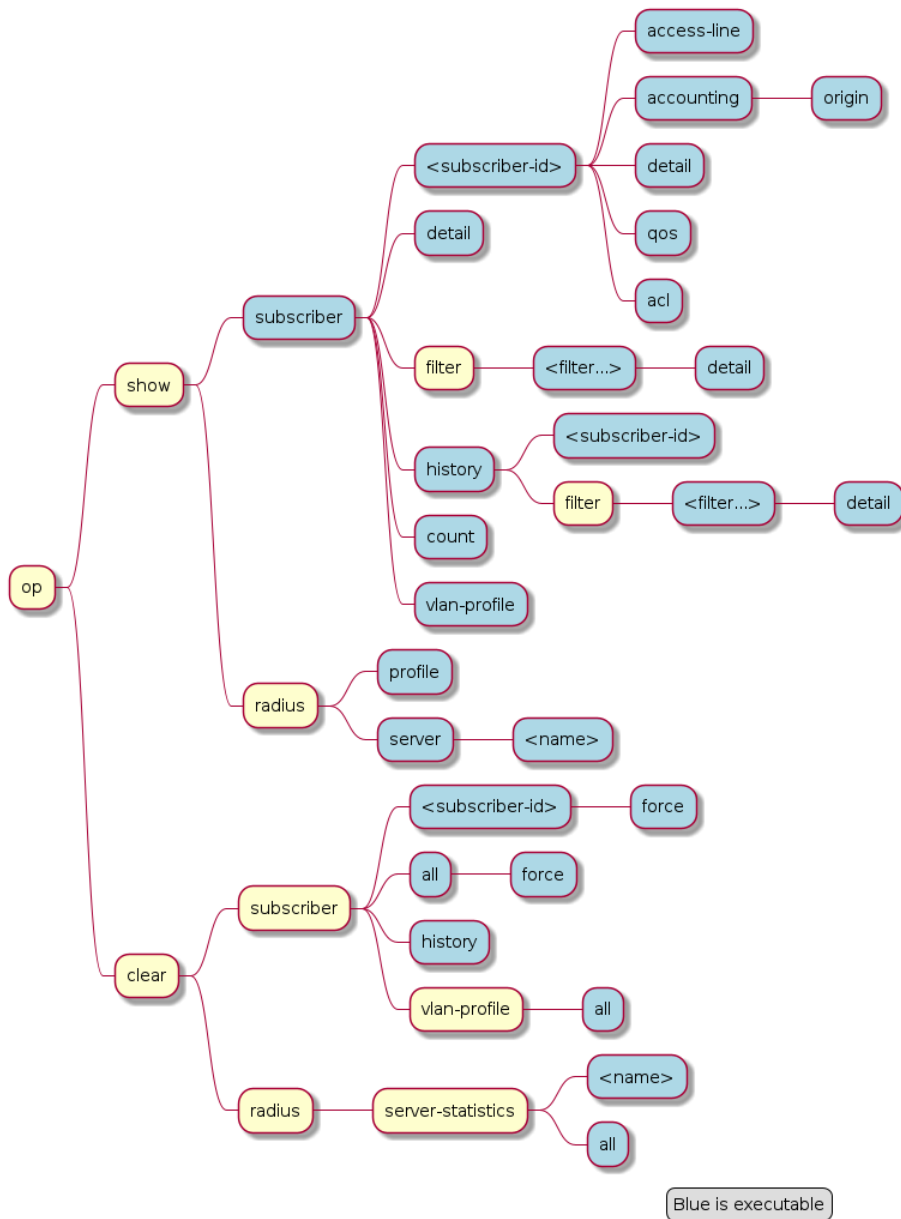

Figure 15. Subscriber Management Operational Commands

## Subscribers

The term subscriber describes an access user or session from a higher level decoupled from underlying protocols like PPPoE or IPoE. Subscribers in RBFS can be managed locally or remote via RADIUS. Each subscriber is uniquely identified by a 64bit number called subscriber-id.

## Subscriber States

A good starting point for troubleshooting subscriber services is to verify the status of the subscriber sessions. The state ESTABLISHED means that the session is fully operational.

```

supervisor@leaf1: op> show subscriber
Subscriber-Id      Interface      VLAN      Type      State
72339069014638600 ifp-0/0/1     1:1       PPPoE     ESTABLISHED
72339069014638601 ifp-0/0/1     1:2       PPPoE     ESTABLISHED
72339069014638602 ifp-0/0/1     1:3       PPPoE     ESTABLISHED
72339069014638603 ifp-0/0/3     2000:7    L2TP     ESTABLISHED

```

Alternative use `show subscriber detail` which shows further details like username, Agent-Remote-Id (aka Line-Id) or Agent-Circuit-Id if screen width is large enough to print all those information.

The meaning of the subscriber state is shown in the following table and diagram.

State	Description
INIT	Initial subscriber state.
AUTHENTICATING	Authenticate the subscriber using the configured method.
ADDRESS ALLOCATION	Allocate (RADIUS or pool) and validate (DAD) addresses.
TUNNEL SETUP	Setup tunnel resources (L2TP or L2X).
IFL SETUP	Create subscriber IFL with corresponding QoS resources.
FULL	Wait for subscriber to be in forwarding state. Inform underlying protocols (PPPoED or IPoED) to continue with session setup.
ACCOUNTING	Start subscriber accounting and wait for response.

---

<b>State</b>	<b>Description</b>
ESTABLISHED	The subscriber becomes ESTABLISHED after response to RADIUS Accounting-Request-Start if RADIUS accounting is enabled otherwise immediately after FULL.
TERMINATING	The subscriber remains in this state until all resources are freed and accounting stopped. This means that subscriber remain in this state until response to RADIUS Accounting-Request-Stop if RADIUS accounting is enabled.

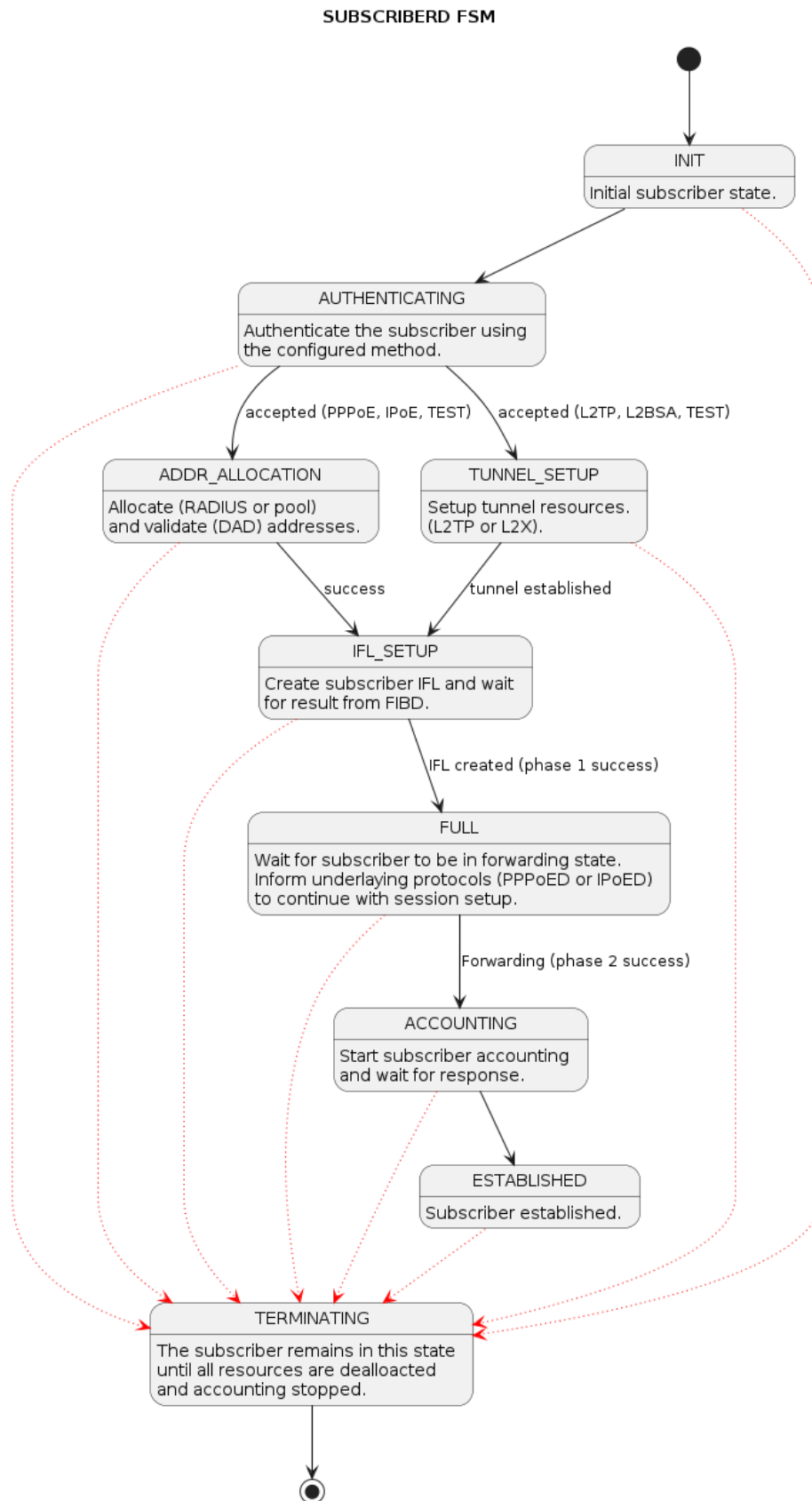

Figure 16. Subscriber States

For each subscriber a set of commands is available showing detailed information.



```

supervisor@leaf1: op> show subscriber 72339069014638594
<cr>
access-line          Subscriber access line information
accounting           Subscriber accounting information
acl                  Subscriber ACL information (filter)
detail               Detailed subscriber information
qos                  Subscriber QoS information

user@switch: op> show subscriber 72339069014638594 detail
Subscriber-Id: 72339069014638594
  Type: PPPoE
  State: ESTABLISHED
  Created: Fri Sep 18 20:50:02 GMT +0000 2020
  Interface: if1-0/0/1
  Outer VLAN: 128
  Inner VLAN: 7
  Client MAC: fe:08:e8:ea:1d:32
  Server MAC: 7a:52:4a:01:00:01
  IFL: ppp-0/0/1/72339069014638594
  Username: 1122334455#123456789#0001@t-online.de
  Agent-Remote-Id: DEU.DTAG.1337
  Agent-Circuit-Id: 0.0.0.0/0.0.0.0 eth 1337
  Access-Profile: access-profile1
  AAA-Profile: aaa-profile1
  Session-Timeout: 30000
  Idle-Timeout: 120
  IPv4:
    Instance: default
    Address: 198.51.100.116/255.255.255.255
    Address Active: True
    Primary DNS: 198.51.100.213
    Secondary DNS: 198.51.100.54
  IPv6:
    Instance: default
    RA Prefix: 2001:db8:0:400::/32
    RA Prefix Active: True
    Delegated Prefix (DHCPv6): 2001:db8:0:269::/56
    Delegated Prefix Active: False
    Primary DNS: 2001:db8:0:92::
    Secondary DNS: 2001:db8:0:174::
  Accounting:
    Session-Id: 72339069014638594:1600462202
    Start-Time: 2020-09-18T20:50:02.738306+0000
    Interims Interval: 30 seconds

```

## Subscriber Termination Codes

The following command shows the reasons why subscribers are terminated for the last 24 hours and up to 4000 subscribers.

```

supervisor@leaf1: op> show subscriber history
Subscriber-Id      Timestamp                                     Terminate Code
72339069014638594  Fri Oct 16 20:17:33 GMT +0000 2020      Accounting-Request-On
Wait
72339069014638595  Fri Oct 16 20:32:19 GMT +0000 2020      PPPoE LCP Terminate
Request Received

```

## Subscriber Count

To view a summary of PPPoE, L2TP, IPoE, and L2BSA subscribers in the Setup, Established, and Terminating state, use the "show subscriber count" command. This command provides information per interface and a total summary based on subscriber type.

```

supervisor@leaf1: op> show subscriber count

```

	Total	Setup	Established	Terminating
Summary	18000	0	18000	0
PPPoE	18000	0	18000	0
L2TP	0	0	0	0
IPoE	0	0	0	0
L2BSA	0	0	0	0
ifp-0/1/30	6000	0	6000	0
PPPoE	6000	0	6000	0
L2TP	0	0	0	0
IPoE	0	0	0	0
L2BSA	0	0	0	0
ifp-0/1/32	6000	0	6000	0
PPPoE	6000	0	6000	0
L2TP	0	0	0	0
IPoE	0	0	0	0
L2BSA	0	0	0	0
ifp-0/1/33	6000	0	6000	0
PPPoE	6000	0	6000	0
L2TP	0	0	0	0
IPoE	0	0	0	0
L2BSA	0	0	0	0

```

supervisor@leaf1: op>

```

## RADIUS

### RADIUS Profile

The following command shows the status of all RADIUS profiles.

```

supervisor@leaf1: op> show radius profile
RADIUS Profile: radius-default
  NAS-Identifier: BNG
  NAS-Port-Type: Ethernet
  Authentication:
    Algorithm: ROUND-ROBIN
  Server:
    radius-server-1
    radius-server-2
  Accounting:
    State: UP
    Stop on Reject: True
    Stop on Failure: True
    Backup: True
    Algorithm: ROUND-ROBIN
  Server:

```

```
radius-server-1
radius-server-2
```

This meaning of the accounting state is explained in the table below.

Code	State	Description
0x00	DISABLED	Change profile accounting state from DISABLED to ACTIVE if at least one server referenced is found with accounting enabled.
0x01	ACTIVE	Server referenced by RADIUS profile but no response received
0x02	STARTING	Send accounting-on and wait for response.
0x05	UP	Change profile accounting state to UP if at least one referenced accounting server is UP.

The profile state becomes immediately ACTIVE if at least one of the referenced accounting servers can be found in RADIUS server table with accounting enabled. Otherwise the profile keeps DISABLED.

If RADIUS Accounting-On is enabled, the profile state becomes STARTING before UP. It is not permitted to send any accounting request start, interim or stop related to a profile in this state. It is also not permitted to send authentication requests if **accounting-on-wait** is configured in addition. The state becomes UP if at least one server in the accounting server list is in a state UP or higher (UNREACHABLE, DOWN, TESTING, DEAD).

A new profile added which references existing used RADIUS servers must not trigger a RADIUS Accounting-On request if at least one of the referenced servers is in a state of UP or higher.

## RADIUS Server

The following command shows the status of all RADIUS servers.

```
supervisor@leaf1: op> show radius server
RADIUS Server      Address      Authentication State Accounting State
radius-server-1    198.51.100.64  ACTIVE          UP
radius-server-2    198.51.100.163  ACTIVE          ACTIVE
radius-server-3    198.51.100.104  ACTIVE          ACTIVE
```

This meaning of those states is explained in the table and diagram below.

<b>Code</b>	<b>State</b>	<b>Description</b>
0x00	DISABLED	RADIUS authentication (authentication state) or accounting (accounting state) is disabled or server not referenced by profile.
0x01	ACTIVE	Server referenced by RADIUS profile but no valid response received.
0x02	STARTING	This state is valid for accounting (accounting state) only during accounting-on is sending (wait for accounting-on response).
0x03	STOPPING	This state is valid for accounting (accounting state) only during accounting-off is sending (wait for accounting-off response).
0x04	FAILED	This state is valid for accounting (accounting state) only if accounting-on/off timeout occurs.
0x05	UP	Valid RADIUS response received
0x06	UNREACHABLE	No response received/timeout but server is still usable.
0x07	DOWN	Server is down but can be selected.
0x08	TESTING	Send a request to test if server is back again. The server will not be selected for another request in this state (use a single request to check if server is back again).
0x09	DEAD	Server is down and should not be selected.

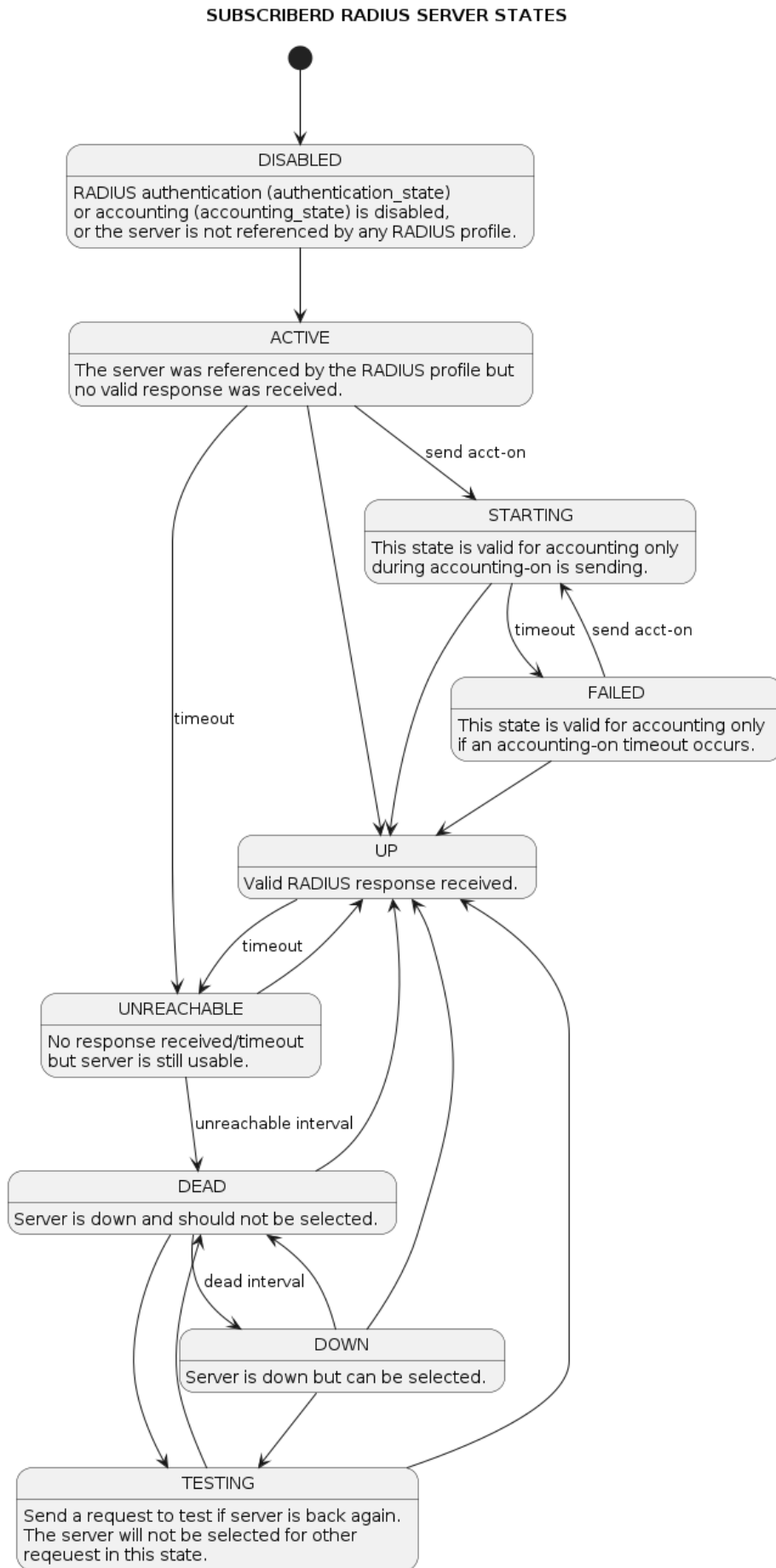

Figure 17. RADIUS Server States

For each server dedicated detailed information are displayed with the following commands.

```
supervisor@leaf1: op> show radius server radius-server-1
RADIUS Server: radius-server-1
  Address: 198.51.100.64
  Source: 198.51.100.200
  Rate: 600 PPS
  Rate Tokens: 600
  Dropped: 0
  Authentication:
    State: ACTIVE
    State Changed: Fri Oct 16 20:17:27 GMT +0000 2020
    Port: 1812
    Retry: 3
    Timeout: 5
    Outstanding: 100
    Statistics:
      Request Sent: 0
      Request Retry: 0
      Request Timeout: 0
      Accept Received: 0
      Reject Received: 0
      Dropped: 0
  Accounting:
    State: UP
    State Changed: Fri Oct 16 20:18:27 GMT +0000 2020
    Port: 1813
    Retry: 10
    Timeout: 30
    Outstanding: 100
    Statistics:
      Request Sent: 1
      Request Retry: 2
      Request Timeout: 0
      Response Received: 1
      Dropped: 0
  CoA:
    Port: 3799
    Statistics:
      Request Received: 0
      Dropped: 0
```

## PPPoE

The following commands are applicable for PPPoE sessions only.

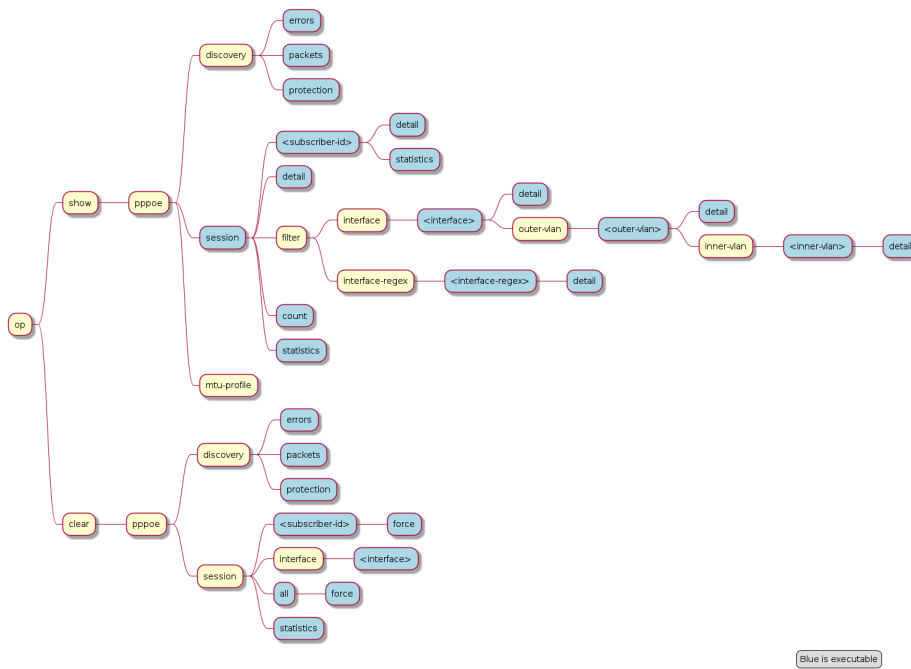

Figure 18. PPPoE Operational Commands

For PPPoE sessions the state should be ESTABLISHED if local terminated or TUNNELLED for L2TPv2 tunnelled sessions.

```

supervisor@rtbrick: op> show pppoe session
Subscriber-Id      Interface      VLAN      MAC              State
72339069014638604 ifp-0/0/1     1:1       00:04:0e:00:00:01 ESTABLISHED
72339069014638601 ifp-0/0/1     1:2       00:04:0e:00:00:02 ESTABLISHED
72339069014638602 ifp-0/0/1     1:3       00:04:0e:00:00:03 ESTABLISHED
72339069014638603 ifp-0/0/3     2000:7    52:54:00:57:c8:29 TUNNELLED
    
```

Alternative use `show pppoe session detail` which shows further details like username, Agent-Remote-Id (aka Line-Id) or Agent-Circuit-Id if screen width is large enough to print all those information.

State	Description
LINKING	PPP LCP setup.
AUTHENTICATING	PPP authentication (PAP or CHAP).
NETWORKING	PPP IPCP (IPv4) and IP6CP (IPv6) setup.
ESTABLISHED	The PPPoE session becomes established if at least one NCP (IPCP or IP6CP) is established (state OPEN).
TUNNELLED	This state indicates that a PPPoE session is tunnelled via L2TPv2.
TERMINATING	PPP session teardown.

State	Description
TERMINATED	PPPoE session terminated.

If PPPoE session remain in state TERMINATED, the subscriber state should be checked. Typically this happens if RADIUS Accounting-Request-Stop is still pending.

Further details per PPPoE session can be shown with the following commands.

```

supervisor@rtbrick: op> show pppoe session 72339069014638648
<cr>
detail                Detailed session information
statistics            Protocol statistics
    
```

The detail command shows the states of the session and all sub-protocols with extensive information and negotiated parameters.

```

user@switch: op> show pppoe session 72339069014638648 detail
Subscriber-Id: 72339069014638648
  State: ESTABLISHED
  Uptime: Tue Nov 17 11:46:43 GMT +0000 2020 (0:00:21.979775)
  Interface: ifp-0/0/3
  Outer VLAN: 10
  Inner VLAN: 7
  Client MAC: 52:54:00:57:c8:29
  Server MAC: 7a:52:4a:c0:00:03
  Session-Id: 55
  Host-Unique: 00000001
  Agent-Remote-Id: DEU.RTBRICK.1
  Agent-Circuit-Id: 0.0.0.0/0.0.0.0 eth 1
  Access-Profile: pppoe-dual
  AAA-Profile: aaa-default
  PPP LCP:
    State: OPENED
    Negotiated Protocols: CHAP, IPCP, IP6CP
    Negotiated Parameters: MRU, AUTH, MAGIC
    Magic Number: 1079931229 Peer: 3432759752
    MRU: 1492 Peer: 1492
    MTU: 1492 Profile: __default_pppoe__
    Echo Interval: 30 seconds
  CHAP Authentication:
    State: COMPLETED
    Username: user1@rtbrick.com
  PPP IPCP:
    State: OPENED
    Instance: default
    IP Address: 198.51.100.200 Peer: 198.51.100.72
    Primary DNS: 198.51.100.88
    Secondary DNS: 198.51.100.54
  PPP IP6CP:
    State: OPENED
    Instance: default
    Interface Identifier: c5f6:1dbd:8cc1:bea9
    Peer Interface Identifier: 5054:00ff:fe57:c829
    
```



```

IPv6:
  RA Interval: 60 seconds
  RA Prefix: 2001:db8:0:246::/32
  Delegated Prefix (DHCPv6): 2001:db8:0:9::/32 Assigned: True
  Primary DNS: 2001:db8:0:114::
  Secondary DNS: 2001:db8:0:115::
Control Traffic Statistics:
  Ingress: 15 packets 1059 bytes
  Egress: 16 packets 1475 bytes

```

Session statistics are available global and per session.

```

supervisor@rtbrick: op> show pppoe session statistics
supervisor@rtbrick: op> show pppoe session 72339069014638601 statistics

```

The PPPoE discovery statistics are helpful if session setup fails in initial PPPoE tunnel setup before actual PPP negotiation is starting.

```

supervisor@rtbrick: op> show pppoe discovery packets

```

Packet	Received	Sent
PADI	17	0
PADO	0	17
PADR	17	0
PADS	0	17
PADT	1	13

```

supervisor@rtbrick: op> show pppoe discovery errors
PADI Drop No Config : 0
PADI Drop Session Protection : 0
PADI Drop Session Limit : 0
PADI Drop Dup Session : 0
PADI Drop Interface Down : 0
PADR Drop No Config : 0
PADR Drop Wrong MAC : 0
PADR Drop Interface Down : 0
PADR Drop Session Limit : 0
PADR Drop Session Protection : 0
PADR Drop Bad Cookie : 0
PADR Drop Bad Session : 0
PADR Drop Dup Session : 0
PADR Drop No mapping Id : 0
PADT Drop No Session : 0
PADT Drop Wrong MAC : 0
PADX Interface Get Failure : 0

```

If PPPoE session protection is enabled in access configuration profile, short lived or failed sessions will be logged in the PPPoE session protection table ([local.pppoe.session.protection](#)).

Every session not established for at least 60 seconds per default is considered as failed or short lived session. This will block new sessions on this IFP and VLAN's for

one second per default which increase exponential with any further failed session until the max time of per default 300 seconds is reached. The interval is reset after 900 seconds without failed sessions.

The PPPoE session protection table include also last subscriber-id and terminate code which indicates the reason for session failures.

```
supervisor@rtbrick: op> show pppoe discovery protection
Interface      VLAN      Status  Attempts  Last Terminate Code
ifp-0/0/1      1:1       OK      1          PPPoE LCP Terminate Request Received
ifp-0/0/1      1:2       OK      1          PPPoE LCP Terminate Request Received
ifp-0/0/1      1:3       OK      1          PPPoE LCP Terminate Request Received
```

If status OK indicates that new session are accepted where BLOCKED means that sessions will be rejected.

## L2TP

The following commands are applicable for L2TP only.

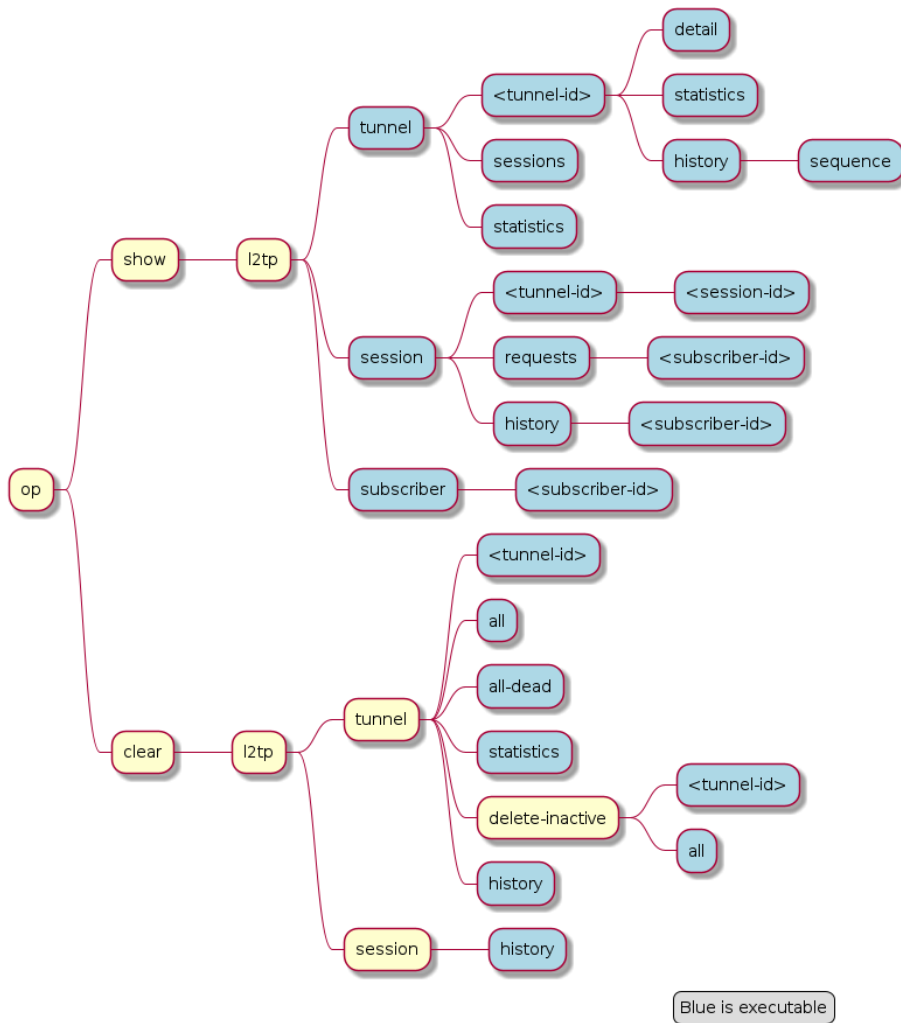

Figure 19. L2TP Operational Commands

For L2TPv2 tunnelled PPPoE sessions the global unique subscriber-id can be used to get information about the L2TP session.

```

supervisor@rtbrick: op> show l2tp subscriber 72339069014638621
Subscriber-Id: 72339069014638621
State: ESTABLISHED
Local TID: 45880
Local SID: 39503
Peer TID: 1
Peer SID: 1
Call Serial Number: 10
TX Speed: 10007000 bps
RX Speed: 1007000 bps
CSUN: disabled
    
```

The following command gives a good overview over the corresponding tunnels.

```

supervisor@leaf1: op> show l2tp tunnel sessions
Role Local TID Peer TID State Preference Sessions Established Peer Name
LAC 2022 1 ESTABLISHED 10000 1 1 LNS3
    
```

LAC	3274	1	ESTABLISHED	10000	1	1	LNS8
LAC	14690	1	ESTABLISHED	10000	1	1	LNS6
LAC	29489	1	ESTABLISHED	10000	1	1	LNS9
LAC	33323	1	ESTABLISHED	10000	1	1	LNS4
LAC	35657	1	ESTABLISHED	10000	1	1	LNS10
LAC	37975	1	ESTABLISHED	10000	1	1	LNS1
LAC	45880	1	ESTABLISHED	10000	1	1	LNS7
LAC	46559	1	ESTABLISHED	10000	1	1	LNS2
LAC	58154	1	ESTABLISHED	10000	1	1	LNS5

Detailed information per tunnel are available via `show l2tp tunnel <TID> detail`.

L2TP tunnel statistics are available global and per tunnel.

```
supervisor@leaf1: op> show l2tp tunnel statistics
supervisor@leaf1: op> show l2tp tunnel 37975 statistics
```

## L2TP Result and Disconnect Codes

The received result (RFC2661) and disconnect (RFC3145) code and message from CDN and StopCCN will be stored similar to the subscriber terminate history table for 24 hours and up to 1000 records.

```
supervisor@leaf1: op> show l2tp tunnel history
Sequence Local TID Peer TID Timestamp Terminate Code
1 34209 0 Wed Jul 28 13:02:35 GMT +0000 2021 Admin Request
2 39860 1 Wed Jul 28 13:02:35 GMT +0000 2021 Admin Request
3 39860 2 Wed Jul 28 13:02:54 GMT +0000 2021 Admin Request
4 39860 3 Wed Jul 28 13:04:29 GMT +0000 2021 StopCCN Received
(Requester is being shut down)
5 39860 1 Wed Jul 28 13:06:19 GMT +0000 2021 StopCCN Received
(Requester is being shut down)

supervisor@leaf1: op> show l2tp tunnel history 4
Local TID: 39860 Peer TID: 3
Terminate Code: StopCCN Received
Timestamp: Wed Jul 28 13:04:29 GMT +0000 2021
Local Address: 198.51.100.102
Peer Address: 198.51.100.133
Peer Name: LNS1
Tunnel-Client-Auth-ID: BNG
Tunnel-Server-Auth-ID: LNS1
Result Code: Requester is being shut down

supervisor@leaf1: op> show l2tp session history
Subscriber-Id Local TID Local SID Terminate Code
72339069014638614 39860 5597 Clear Session
72339069014638615 39860 5208 Clear Session
72339069014638623 39860 29626 Clear Session
72339069014638624 39860 42480 L2TP Tunnel Down
72339069014638625 39860 34417 L2TP Tunnel Down
72339069014638626 39860 20229 L2TP Tunnel Down
```

The `show subscriber history <subscriber-id>` command will also return L2TP details if found for the corresponding subscriber.

```

supervisor@leaf1: op> show subscriber history 72339069014638703
Subscriber-Id: 72339069014638703
  Terminate Code: L2TP CDN Request
  Timestamp: Wed Jul 28 13:06:18 GMT +0000 2021
  Interface: if1-0/0/1
  Outer VLAN: 1000
  Inner VLAN: 2002
  Client MAC: 02:00:00:00:00:04
  Username: blaster@l2tp.de
  Agent-Remote-Id: DEU.RTBTRICK.2
  Agent-Circuit-Id: 0.0.0.0/0.0.0.0 eth 0:2
  Accounting-Session-Id: 72339069014638703:1627477569
  L2TP Disconnect Cause:
    Code: Normal disconnection (LCP terminate-request)
    Protocol: 0
    Direction: Peer
    Message: N/A
    
```

## IPoE

The following commands are applicable for IPoE subscribers only.

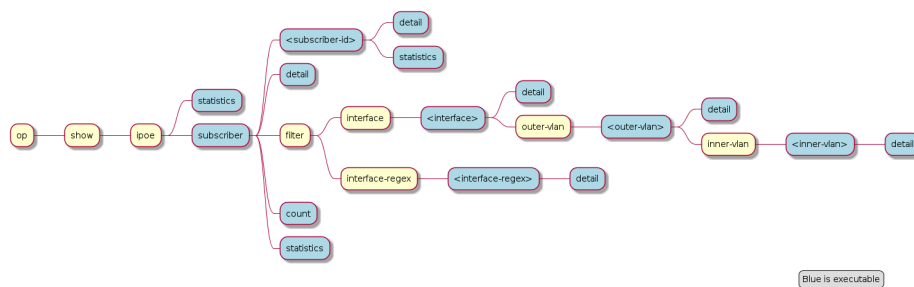

Figure 20. IPoE Operational Commands

```

supervisor@leaf1: op> show ipoe subscriber detail
Subscriber-Id      Interface      VLAN      MAC      State
DHCPv4            DHCPv6
216454257090494465  if1-0/0/1      8:1      02:00:00:00:00:01  ESTABLISHED
Bound            Bound
216454257090494466  if1-0/0/1      8:2      02:00:00:00:00:02  ESTABLISHED
Bound            Bound
216454257090494467  if1-0/0/1      8:3      02:00:00:00:00:03  ESTABLISHED
Bound            Bound
216454257090494468  if1-0/0/1      8:4      02:00:00:00:00:04  ESTABLISHED
Bound            Bound
    
```

Further details per subscriber can be shown with the following command.

```

supervisor@leaf1: op> show ipoe subscriber 216454257090494465 detail
    
```

```

Subscriber-Id: 216454257090494465
State: ESTABLISHED
Uptime: Mon Jun 14 15:46:15 GMT +0000 2021 (0:02:19.421591)
Interface: if1-0/0/1
Outer VLAN: 8
Inner VLAN: 1
Client MAC: 02:00:00:00:00:01
Gateway Interface: lo-0/0/0/1
Gateway Instance: default
Gateway IPv4: 198.51.100.200/255.255.255.255
Gateway MAC: 7a:52:4a:c0:00:01
Agent-Remote-Id: DEU.RTBRICK.1
Agent-Circuit-Id: 0.0.0.0/0.0.0.0 eth 0:1
DHCPv4:
  Mode: Server
  State: Bound
  Address: 198.51.100.202/255.255.255.255
  Lease Created: Mon Jun 14 15:46:15 GMT +0000 2021 (0:02:19.427443)
  Lease Time: 300 seconds
  Lease Expire: 161 seconds
DHCPv6:
  Mode: Server
  State: Bound
  Client DUID: 00030001020000000001
  Server DUID: 0003001b78524afffec00001
  IA_NA:
    Address: 2001:db8:0:96
    IAID: 1181407340
    Active: True
  IA_PD:
    Prefix: 2001:db8:0:333/32
    IAID: 4095128883
    Active: True
  Lease Created: Mon Jun 14 15:46:15 GMT +0000 2021 (0:02:19.428676)
  Lease Time (Lifetime): 14400 seconds
  Lease Expire: 14261 seconds
  Preferred Lifetime: 1800 seconds
    
```

## Local Address Pools



Rather than using recommended IP addresses for technical documents, the document shows actual IP pool ranges.

The usage of local address pools can be monitored using the `show subscriber pool` commands as shown below.

```

supervisor@switch: op> show subscriber pool summary
Pool Name           AFI  Usage           Range
pool-A              IPv4  256/256         10.0.1.0 - 10.0.1.255
pool-B              IPv4   2/256          10.0.2.0 - 10.0.2.255
pool-C              IPv4   0/256          10.0.3.0 - 10.0.3.255
pool-D              IPv4   0/256          10.0.4.0 - 10.0.4.255

supervisor@switch: op> show subscriber pool ipv4 pool-A
Pool Name: pool-A
AFI: IPv4
    
```

```
Usage: 256/256
Range: 10.0.1.0 - 10.0.1.255
Next: pool-B
```

```
supervisor@switch: op> show subscriber pool ipv4 pool-B
Pool Name: pool-B
  AFI: IPv4
  Usage: 2/256
  Range: 10.0.2.0 - 10.0.2.255
  Next: pool-C
```

```
supervisor@switch: op> show subscriber pool ipv4 pool-B allocation
Subscriber-Id      Timestamp                                     Address/Prefix
72339069014638598  Wed Sep 15 09:02:15 GMT +0000 2021    10.0.2.0
72339069014638602  Wed Sep 15 09:02:15 GMT +0000 2021    10.0.2.1
```

## 5.1.4. Supported Standards



RFCompliance and draft compliance are partial except as specified.

### PPPoE

- RFC 1516
- RFC 1661 (partly)
- RFC 1332 (partly)
- RFC 5072 (partly)
- RFC 1334 (partly)

### RADIUS

- RFC 2865 (partly)
- RFC 3162 (partly)
- RFC 2866 (partly)
- RFC 4372 (partly)
- RFC 2869 (partly)

### DHCPv4

- RFC 951 (partly)
- RFC 1542 (partly)
- RFC 2131 (partly)

- RFC 2132 (partly)
- RFC 3046 (partly)

## DHCPv6

- RFC 8415 (partly)

## Access Line Information

The access line identification and characterization information are defined in the Broadband Forum (BBF) formerly known DSL Forum attributes including Agent-Remote-Id and Agent-Circuit-Id.

See the following references for more information about access line attributes.

- RFC 4679 DSL Forum Vendor-Specific RADIUS Attributes
- RFC 6320 ANCP (partly)
- Broadband Forum TR-101 (partly)
- draft-lihawi-ancp-protocol-access-extension-04 (partly)

## L2TPv2



RFc and draft compliance are partial except as specified.

### RFc 2661 - Layer Two Tunneling Protocol (L2TPv2)

RFc compliant L2TPv2 Access Concentrator (LAC) with the following protocol limitations:

- No support for LNS initiated outbound calls (OCRQ, OCRP and OCCN)
- No support for WAN-Error-Notify (WEN) Messages send by LAC to LNS
- No support for Set-Link-Info (SLI) Messages send by LNS to LAC
- No support for L2TP over IPv6
- No support for L2TP offset values other than 0.

### RFc 5515 - L2TP Access Line Information AVP Extensions

- Support for access line AVP send (LAC) and received (LNS) as part of the L2TP



Incoming-Call- Request (ICRQ) message.

- Response to Connect-Speed-Update-Request (CSURQ) L2TP messages is currently not supported.

### **RFC 2868 - RADIUS Attributes for Tunnel Protocol Support**

RADIUS support for L2TP with the following limitations:

- No support of FQDN format for IP addresses
- No support Tunnel-Medium-Type other than IPv4

### **RFC 3145 - L2TP Disconnect Cause Information**

Send meaningful disconnect cause information to LNS and display received disconnect cause information for tunnels and sessions.

### **Supported Hardware**

You can find more detailed information about what RtBrick features are supported on each hardware platform, see the *Platform Guide*.

## **5.2. RBFS RADIUS Services**

### **5.2.1. RADIUS Services Overview**

The modular, scalable subscriber management that RtBrick calls the next generation access infrastructure (ng-access) provides support for protocols such as PPPoE, IPoE, L2TP and RADIUS.

The subscriber management infrastructure provides the next generation of internet access protocols designed for carrier grade services in regards to scalability and robustness. One of the challenges for carrier networks is interwork with numerous client devices which requires a well implemented, industry proven access protocol stack, including support for all relevant RFCs.

This implementation is designed to be a set of distributed services for increased scaling and stability. The subscriber management implementation has three components:

- subscriberd: subscriber management and AAA (local, RADIUS, and other

support)

- pppoe: PPPoE/PPP session handling
- l2tpd: L2TP tunnel and session handling

The subscriber daemon (subscriberd) is the central application, keeping the current subscriber state as well as being responsible for Authentication, Authorization and Accounting (AAA).

This document describes the subscriber management RADIUS service implementation on RBFS. The term subscriber describes an access user or session from a higher level decoupled from underlying protocols like PPPoE or IPoE. Subscribers in RBFS can be managed locally or via RADIUS where this document considers RADIUS only. Each subscriber is uniquely identified by a 64bit number called subscriber-id. Remote Authentication Dial-In User Service (RADIUS) is a networking protocol that provides centralized Authentication, Authorization and Accounting (AAA) management for all types of subscribers (PPPoE, or IPoE). RADIUS servers can perform as authentication and accounting servers or change of authorization (CoA) clients. Authentication servers maintain authentication records for subscribers. The subscriber daemon requests authentication in RADIUS access-request messages before permitting subscribers access. Accounting servers handle accounting records for subscribers. The subscriber daemon transmits RADIUS accounting-start, interim and stop messages to the servers. Accounting is the process of tracking subscriber activity and network resource usage in a subscriber session. This includes the session time called time accounting and the number of packets and bytes transmitted during the session called volume accounting.

A RADIUS server can behave as a change of authorization (CoA) client allowing dynamic changes for subscriber sessions. The subscriber daemon supports both RADIUS CoA messages and disconnect messages. CoA messages can modify the characteristics of existing subscriber sessions without loss of service, disconnect messages can terminate subscriber sessions.

Each RADIUS request from subscriber daemon includes the RADIUS accounting-session-id attribute (type 44) with a format which is configurable in the AAA profile and includes at least the subscriber-id to identify the corresponding subscriber. The default format (<subscriber-id>.<timestamp>) includes also an Unix timestamp to ensure that the tuple of NAS-Identifier (e.g. hostname) and Accounting-Session-Id is global unique to be usable as key in RADIUS databases.

Additionally to subscriber-id and accounting-session-id each subscriber consists also of a subscriber-ifl build based on physical port information and subscriber-id (ifp: ifp-0/0/1 and subscriber-id: 72339069014638610 subscriber-ifl: ppp-0/0/1/72339069014638610) which is required as handle in the RBFS forwarding infrastructure. All those three informations are part of the RADIUS access-request message:

- accounting-session-id: standard attribute 44
- subscriber-id: RtBrick VSA (26-50058-25 RtBrick-Subscriber-Id)
- subscriber-ifl: RtBrick VSA (26-50058-26 RtBrick-Subscriber-IfI)

```
Code: Access-Request (1)
Packet identifier: 0x22 (34)
Length: 416
Authenticator: e61a0dd74c74704f608688b08de1dfba
\[The response to this request is in frame 12\]
▼ Attribute Value Pairs
  ▶ AVP: t=User-Name(1) l=19 val=user1@rtbrick.com
  ▶ AVP: t=CHAP-Challenge(60) l=18 val=2f696f4e920b47cab869021feb2bf632
  ▶ AVP: t=CHAP-Password(3) l=19 val=02f439040e9feb7bbc9e7622a364344913
  ▶ AVP: t=NAS-IP-Address(4) l=6 val=1.1.1.1
  ▶ AVP: t=NAS-Identifier(32) l=5 val=BNG
  ▶ AVP: t=NAS-Port-Id(87) l=59 val=BNG#hostif-0/0/4#10#7#0.0.0.0/0.0.0.0 eth 1#DEU.RTBRICK.1
  ▶ AVP: t=NAS-Port(5) l=6 val=67149831
  ▶ AVP: t=NAS-Port-Type(61) l=6 val=Ethernet(15)
  ▶ AVP: t=Service-Type(6) l=6 val=Framed(2)
  ▶ AVP: t=Framed-Protocol(7) l=6 val=PPP(1)
  ▶ AVP: t=Acct-Session-Id(44) l=30 val=72339069014638895:1589876315
  ▶ AVP: t=Vendor-Specific(26) l=13 vnd=RtBrick Inc.(50058)
  ▶ AVP: t=Vendor-Specific(26) l=20 vnd=RtBrick Inc.(50058)
  ▶ AVP: t=Vendor-Specific(26) l=16 vnd=RtBrick Inc.(50058)
  ▶ AVP: t=Vendor-Specific(26) l=25 vnd=RtBrick Inc.(50058)
  ▼ AVP: t=Vendor-Specific(26) l=16 vnd=RtBrick Inc.(50058)
    Type: 26
    Length: 16
    Vendor ID: RtBrick Inc. (50058)
  ▶ VSA: t=RtBrick-Subscriber-Id(25) l=10 val=010100000000012f
  ▼ AVP: t=Vendor-Specific(26) l=35 vnd=RtBrick Inc.(50058)
    Type: 26
    Length: 35
    Vendor ID: RtBrick Inc. (50058)
  ▶ VSA: t=RtBrick-Subscriber-IfI(26) l=29 val=ppp-0/0/4/72339069014638895
  ▶ AVP: t=Vendor-Specific(26) l=29 vnd=The Broadband Forum(3561)
  ▶ AVP: t=Calling-Station-Id(31) l=23 val=0.0.0.0/0.0.0.0 eth 1
  ▶ AVP: t=Vendor-Specific(26) l=21 vnd=The Broadband Forum(3561)
  ▶ AVP: t=Vendor-Specific(26) l=18 vnd=The Broadband Forum(3561)
```



The subscriber-id is an unsigned 64bit integer which is shown as a hex number in Wireshark.

Each subscriber is formed based on configuration profiles and individual settings retrieved via RADIUS. Conflicts between RADIUS defined attributes and profile attributes are solved by prioritizing those received from RADIUS which is common

best practices for broadband access concentrators. New subscribers are signalled via RADIUS access-request and either accepted by RADIUS access-accept or rejected by RADIUS access-reject message from RADIUS server. The RADIUS access-accept includes all attributes required to form the subscriber like IP addresses, DNS servers and referenced configuration profiles. Some of those attributes can be changed by RADIUS dynamically using CoA requests without disconnecting the subscriber.

Some of those attributes refer to RADIUS services which are described in detail in this document. The term RADIUS services described the ability to dynamically control the properties of a session via RADIUS used by access providers to build their different products and services based on their network infrastructure. This is used to control QoS settings like shaper rates dynamically based on changed line quality or possible volume quotas. It is also used to dynamically enable or disable services like Voice or IPTV on a per subscriber basis.

The RADIUS accounting accuracy should comply with §45g of the German Telecommunications Act (TKG) further named by TKG§45. This applies for time and volume based products and services. Products or services with unlimited volumes but with changed properties after a certain amount of traffic are considered as volume based products as well. One example here is a fair use policy which enforces a rate limit after a certain volume. The requirements for time based accounting apply only to products or services which are charged by time or changed properties after a certain time which is not very common in the market today.

## Supported Platforms

Not all features are necessarily supported on each hardware platform. Refer to the *Platform Guide* for the features and the sub-features that are or are not supported by each platform.

### 5.2.2. RADIUS Service Solution Overview

The general concept of RADIUS services in RtBrick FullStack (RBFS) consists of pre-configured profiles in the global static configuration assigned to dynamic subscribers via RADIUS VSA in access-accept and CoA request messages. The profiles are managed as any other configuration in RBFS via corresponding API which is not explained here in detail.

The following pictures show the concept of global static configurations referenced by RADIUS controlled dynamic subscribers.

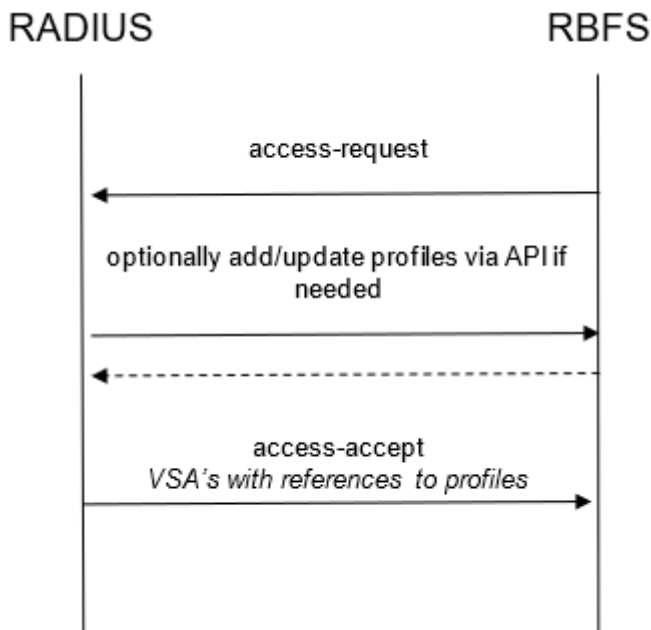
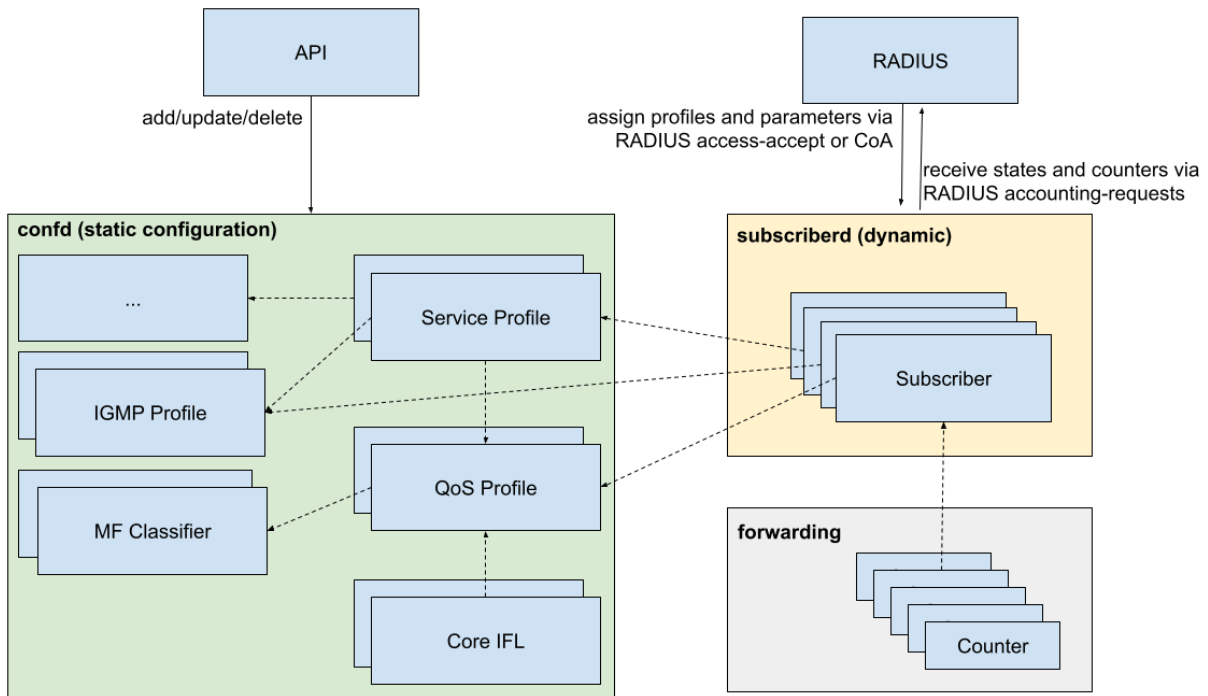

The required profiles and filters should be present before service becomes active which can be done immediately after start-up or between access-request and access-accept as shown in the flow diagram on the left.

## 5.2.3. RADIUS Control

This chapter explains the subscriber and service-related RBFS extensions and RtBrick VSA related to RADIUS services.

### RADIUS Session and Idle Timeout

The session and idle timeout values are initialized with zero, which means infinity or disabled. Those values will be optionally overwritten with the values in AAA configuration profile and RADIUS access-accept if present. The priority is RADIUS attributes over AAA configuration profile.

The session (attribute 27) and idle (attribute 28) timeout RADIUS attributes are defined in RFC 2865.



RFC and draft compliance are partial except as specified.

The idle timeout is based on outgoing logical interface statistics (OutLIF) for the subscriber-ifl to determine subscriber inactivity.

### RADIUS Routing Instance

#### ***VSA 26-50058-137 - RtBrick-Instance***

This attribute is applicable to non-IPoE subscribers only. It allows to change the routing instance through a RADIUS access-accept message.

For IPoE subscribers, the routing instance is automatically determined based on the gateway IFL.

### RADIUS Gateway-IfI

#### ***VSA 26-50058-138 - RtBrick-Gateway-IfI***

This attribute is applicable to IPoE subscribers only. It allows to change the actual gateway IFL. Consequently, this also indirectly modifies the routing instance through a RADIUS Access-Accept message.

### RADIUS DNS Server

#### ***VSA 26-50058-131 - RtBrick-DNS-Primary***

**VSA 26-50058-132 - RtBrick-DNS-Secondary****VSA 26-50058-134 - RtBrick-DNS-Primary-IPv6****VSA 26-50058-135 - RtBrick-DNS-Secondary-IPv6**

Those attributes allow to set the primary and secondary IPv4 and IPv6 DNS servers via RADIUS access-accept. DNS servers already set via access configuration profile will be overwritten by RADIUS.

**RADIUS Service Profile****VSA 26-50058-70 - RtBrick-Service-Profile**

Subscribers can be associated with a service-profile which defines the actual service properties like QoS or IGMP profiles and configuration settings. The service profile can be assigned or changed using the RtBrick-Service-Profile VSA.

```
RtBrick-Service-Profile = <service-profile>
```

This attribute is supported via RADIUS access-accept and CoA requests.

All dynamic QoS settings like shaper and policer rates will be reset if the new service-profile includes a qos-profile attribute also if active qos-profile and old qos-profile is equal. All QoS settings remain unchanged if the referenced service profile does not include the qos-profile attribute. If the referenced service profile updates the qos-profile attribute and additional shaper or policer rates are included in the same CoA request which updates the service-profile, those shaper and policer settings will be applied to the new QoS configuration profile after reset. This means that we reset all incremental changes done before. In example if Voice shaper rate has changed to another value, after profile change the default value from profile is used.

RADIUS CoA requests referencing a service profile which is not found on device will be rejected with CoA-NAK (invalid-request) but without changing any subscriber QoS settings. This behavior is different for RADIUS access-accept where service profiles are just ignored if not found. In both cases a warning is generated in subscriber daemon log if a referenced service profile is not found.

## RADIUS AAA Profile

### ***VSA 26-50058-69 - RtBrick-AAA-Profile***

This attribute allows to change the associated AAA profile from RADIUS access-accept. This is primarily used to change the accounting adjustment values which are defined in this profile. Simple example here is to use different adjustment values for L2TP and local terminated PPPoE sessions. Another valid use case is to assign different RADIUS accounting servers for in example L2TP sessions or wholesale customers.

```
RtBrick-AAA-Profile = <aaa-profile>
```

This attribute is supported via RADIUS access-accept only.

## RADIUS QoS Profile

### ***VSA 26-50058-62 - RtBrick-QoS-Profile***

```
RtBrick-QoS-Profile = <qos-profile>
```

This attribute is supported by RADIUS access-accept and CoA request. The QoS configuration profile can be either selected via service-profile or directly using this attribute which has priority of the service-profile.

All dynamic QoS settings like MFC, queue sizes, shaper and policer rates will be reset if this attribute is present in a CoA request also if new qos-profile and old qos-profile is equal. If additional shaper or policer rates are included in the same CoA request which updates the service-profile, those shaper and policer settings will be applied to the new QoS configuration after reset.

The subscriber management infrastructure does not check if a referenced QoS profile exists or not. This is handled by forwarding infrastructure which continues processing the subscriber QoS settings as soon as the profile was added. In the meantime there is no QoS configuration applied.

## RADIUS QoS Parent Scheduler

### ***VSA 26-50058-64 - RtBrick-QoS-Parent-Scheduler***

The parent scheduler element of the scheduler-map assigned to the subscriber



can be selected with this attribute. If not present, the scheduler-map will be directly bound to the local IFP where the session is established.

This attribute is supported in RADIUS access-accept only (no CoA support) and will set the parent scheduler element of the subscriber.



Providing a QoS parent scheduler which is not present on the corresponding IFP will lead to black howling of all egress data traffic. Control traffic is not impacted and therefore the session will remain.

## RADIUS QoS Shaper

### ***VSA 26-50058-63 - RtBrick-QoS-Shaper***

Subscribers can be associated with a QoS profile which is assigned via service-profile or directly via corresponding VSA (RtBrick-QoS-Profile). This profile is used to instantiate the QoS resources for the subscriber including schedulers, queues and shapers. The assigned shaper instances can be updated using the RtBrick-QoS-Shaper VSA (attribute 26-50058-63) which will apply to the QoS instance of the corresponding subscriber only, but not to the other subscribers using the same QoS profile. It is only possible to update existing shapers dynamically but it is not possible to create a new shaper via RADIUS.

The RtBrick-QoS-Shaper value is a string which contains a list of multiple shaper settings separated by semicolon. Each shaper setting contains a shaper name, high flow rate and low flow rate separated by comma. The actual shaper rate is the sum of high and low flow rate.

```
RtBrick-QoS-Shaper = <shaper-name>,<high-kbps>,<low-kbps>;<shaper-name>,...
```

This attribute can be also used as a key-value list which is automatically recognized by RBFS.

```
RtBrick-QoS-Shaper = name=<shaper-name>,high=<high-kbps>,low=<low-kbps>;...
```

This attribute is supported by RADIUS access-accept and CoA request.

Updating a single shaper (e.g. voice\_shaper) via CoA does not require to include other shapers meaning that only the shapers included in the attribute will be

updated and all other shapers remain unchanged.

Assume the following example which adapts the session and voice shaper instance of a subscriber.

```
supervisor@rtbrick: op> show config forwarding-options class-of-service shaper
shaper_session
{
  "rtbrick-config:shaper": {
    "shaper-name": "shaper_session",
    "shaping-rate-high": 48000,
    "shaping-rate-low": 2000
  }
}
supervisor@rtbrick: op> show config forwarding-options class-of-service shaper
shaper_voice
{
  "rtbrick-config:shaper": {
    "shaper-name": "shaper_voice",
    "shaping-rate-high": 1000,
    "shaping-rate-low": 0
  }
}
```

## RADIUS VSA Change Session Shaper Only

```
RtBrick-QoS-Shaper: shaper_session,14000,2000
```

## RADIUS VSA Change Session and Voice Shaper

```
RtBrick-QoS-Shaper: shaper_session,14000,2000;shaper_voice,2000
```

All active dynamic shapers are stored in the table **global.access.1.subscriber.qos.shaper** to handover those information to forwarding infrastructure. This table can be used to verify the dynamic shapers which are active for a given subscriber.

The CLI command `show subscriber <id> qos` displays those information in a nice human readable format.

```
supervisor@rtbrick: op> show subscriber 72339069014638610 qos
Subscriber-Id: 72339069014638610
Interface: ifp-0/0/1
Outer VLAN: 128
Inner VLAN: 7
IFL: ppp-0/0/1/72339069014638610
Profile: qos_profile
Parent: pon1
```

```
Dynamic Shaper: shaper_voice
  Rate Low: 0 kbps
  Rate High: 2000 kbps
Dynamic Shaper: shaper_session
  Rate Low: 2000 kbps
  Rate High: 14000 kbps
```



A shaper rate of 0 means infinity!

## RADIUS QoS Policer

### VSA 26-50058-65 - RtBrick-QoS-Policer

The RtBrick-QoS-Policer value is a string which contains a list of multiple policer level settings separated by semicolon. Each setting contains a level, cir, cbs, pir, pbs, max-cir and max-pir separated by comma.

```
RtBrick-QoS-Policer = <level>,<cir>,<cbs>,<pir>,<pbs>,<max-cir>,<max-pir>;<level>...
```

*Example:*

```
RtBrick-QoS-Policer = 1,2000,200;2,8000,800;3,0,800;4,0,800
```

- **level:** 1 (highest priority) to 4 (lowest priority)
- **cir:** Ingress policer committed information rate (kbps)
- **cbs:** Ingress policer committed burst size (kbits)
- **pir:** Ingress policer peak information rate (kbps)
- **pbs:** Ingress policer peak burst size (kbits)
- **max-cir:** max ingress policer committed information rate (kbps)
- **max-pir:** max ingress policer peak information rate (kbps)

If PIR and PBS are not defined, the values from CIR and CBS are used as PIR and PBS as well. The max CIR and max PIR attributes are optional default set to unlimited.

This attribute can be also used as a key-value list which is automatically recognized by RBFS.

```
RtBrick-QoS-Policer = level=<level>,cir=<cir>,cbs=<cbs>,pir=<pir>,pbs=<pbs>,max-cir=<max-cir>,max-pir=<max-pir>;...
```

*Example:*

```
RtBrick-QoS-Policer = level=4,cir=1m,cbs=256;cir=2m,cbs=512,level=3
```

This attribute is supported by RADIUS access-accept and CoA request.

Updating a single policer level via CoA does not require to include other levels meaning that only the levels included in the attribute will be updated and all other levels remain unchanged. It is only possible to update existing policer levels dynamically but it is not possible to create a new level via RADIUS.

Assume the following example which adapts the just one level as well as all levels of a subscriber.

```
supervisor@rtbrick: op> show config forwarding-options class-of-service policer
policer-residential
{
  "rtbrick-config:policer": {
    "policer-name": "policer-residential",
    "level1-rates": {
      "cir": 1000,
      "cbs": 100,
      "pir": 1000,
      "pbs": 100
    },
    "level2-rates": {
      "cir": 4000,
      "cbs": 400,
      "pir": 4000,
      "pbs": 400
    },
    "level3-rates": {
      "cir": 0,
      "cbs": 800,
      "pir": 0,
      "pbs": 800
    },
    "level4-rates": {
      "cir": 0,
      "cbs": 800,
      "pir": 0,
      "pbs": 800
    },
    "levels": 4,
    "type": "two-rate-three-color"
  }
}
```

## RADIUS VSA Change Level 2 Only

```
RtBrick-QoS-Policer: 2,12000,1200
```

## RADIUS VSA Change all Levels

```
RtBrick-QoS-Policer: 1,2000,200;2,8000,800;3,0,800;4,0,800
```

All active dynamic policer level settings are stored in the table **global.access.1.subscriber.qos** to handover those information to forwarding infrastructure. This table can be also used to verify the dynamic policer settings for a given subscriber.

The CLI command `show subscriber <id> qos` displays those information in a nice human readable format.

```
supervisor@rtbrick: op> show subscriber 72339069014638610 qos
Subscriber-Id: 72339069014638610
  Interface: ifp-0/0/1
  Outer VLAN: 128
  Inner VLAN: 7
  IFL: ppp-0/0/1/72339069014638610
  Profile: qos_profile
  Parent: pon1
  Dynamic Ingress Policer Level 1:
    CIR: 2000 kbps CBS: 200 kbps
    PIR: 2000 kbps PBS: 200 kbps
  Dynamic Ingress Policer Level 2:
    CIR: 8000 kbps CBS: 800 kbps
    PIR: 8000 kbps PBS: 800 kbps
  Dynamic Ingress Policer Level 3:
    CIR: 0 kbps CBS: 800 kbps
    PIR: 0 kbps PBS: 800 kbps
  Dynamic Ingress Policer Level 4:
    CIR: 0 kbps CBS: 800 kbps
    PIR: 0 kbps PBS: 800 kbps
  Dynamic Shaper: shaper_voice
    Rate Low: 0 kbps
    Rate High: 2000 kbps
  Dynamic Shaper: shaper_session
    Rate Low: 2000 kbps
    Rate High: 14000 kbps
```

## RADIUS QoS MFC

### VSA 26-50058-66 - RtBrick-QoS-MFC

The multifield classifier can be either derived from qos-profile or directly using this attribute which has priority of the qos-profile.

```
RtBrick-QoS-MFC = <mfc-name>
```

This attribute is supported by RADIUS access-accept and CoA request.

The subscriber management infrastructure does not check if a referenced multifield classifier exists or not. This is handled by forwarding infrastructure which continues processing the subscriber QoS settings as soon as the classifier was added.

The string received in these attributes should be stored as `mf_classifier_name` in the RADIUS attribute object and as well as in the corresponding subscriber-qos object.

## **RADIUS QoS Queues**

### ***VSA 26-50058-67 - RtBrick-QoS-Queues***

Subscribers can be associated with a QoS profile which is assigned via service-profile or directly via corresponding VSA (RtBrick-QoS-Profile). This profile is used to instantiate the QoS resources for the subscriber including schedulers, queues and shapers. The assigned queue instances can be updated using the RtBrick-QoS-Queues VSA (attribute 26-50058-67) which will apply to the QoS instance of the corresponding subscriber only, but not to the other subscribers using the same QoS profile. It is only possible to update existing queues dynamically but it is not possible to add queues via RADIUS.

The RtBrick-QoS-Queues value is a string which contains a list of multiple queue settings separated by semicolon. Each queue setting contains a queue name and queue size in bytes separated by comma.

```
RtBrick-QoS-Queues = <queue-name>,<size-bytes>;<queue-name>,<size-bytes>;...
```

This attribute can be also used as a key-value list which is automatically recognized by RBFS.

```
RtBrick-QoS-Queues = name=<queue-name>,size=<size-bytes>;name=...
```

This attribute is supported by RADIUS access-accept and CoA request.

Updating a single queue (e.g. best-effort) via CoA does not require to include other queues meaning that only the queues included in the attribute will be updated and

all other queues remain unchanged.

The subscriber management infrastructure does not check if a referenced queue exists or not. This is handled by forwarding infrastructure which continues processing the subscriber QoS settings as soon as the queue was added.

All active dynamic queues are stored in the table **global.access.1.subscriber.qos.queue** to handover those information to forwarding infrastructure. This table can be also used to verify the dynamic queues which are active for a given subscriber.

The CLI command `show subscriber <id> qos` displays those information in a nice human readable format.

```
supervisor@rtbrick: op> show subscriber 72339069014638610 qos
Subscriber-Id: 72339069014638610
  Interface: ifp-0/0/1
  Outer VLAN: 128
  Inner VLAN: 7
  IFL: ppp-0/0/1/72339069014638610
  Profile: qos_profile
  Parent: pon1
  Dynamic Ingress Policer Level 1:
    CIR: 2000 kbps CBS: 200 kbps
    PIR: 2000 kbps PBS: 200 kbps
  Dynamic Ingress Policer Level 2:
    CIR: 8000 kbps CBS: 800 kbps
    PIR: 8000 kbps PBS: 800 kbps
  Dynamic Ingress Policer Level 3:
    CIR: 0 kbps CBS: 800 kbps
    PIR: 0 kbps PBS: 800 kbps
  Dynamic Ingress Policer Level 4:
    CIR: 0 kbps CBS: 800 kbps
    PIR: 0 kbps PBS: 800 kbps
  Dynamic Shaper: shaper_voice
    Rate Low: 0 kbps
    Rate High: 2000 kbps
  Dynamic Shaper: shaper_session
    Rate Low: 2000 kbps
    Rate High: 14000 kbps
  Dynamic Queue: voice
    Size: 200000 byte
```

## RADIUS IGMP Attributes

IGMP service can be dynamically enabled on a subscriber using Radius IGMP Attributes. These attributes are supported by RADIUS access-accept and CoA requests.

Following IGMP related attributes are supported:

**VSA 26-50058-71 - RtBrick-IGMP-Status**

This attribute can dynamically enable/disable IGMP for a subscriber

Value	Code	Description
DISABLED	0	Disable IGMP
ENABLED	1	Enable IGMP

**VSA 26-50058-72 - RtBrick-IGMP-Profile**

```
RtBrick-IGMP-Profile = <igmp-profile>
```

This attribute specifies the IGMP-profile to be associated with the subscriber. IGMP profile is configured locally in IGMP with all the IGMP related attributes. This attribute can dynamically associate such a locally configured profile to a subscriber

The subscriber management infrastructure does not check if a referenced IGMP profile exists or not. This is handled by IGMP infrastructure which continues processing the subscriber IGMP settings as soon as the profile was added.

**VSA 26-50058-73 - RtBrick-IGMP-Version**

This attribute can specify the version of IGMP for a subscriber.

Value	Code	Description
V1	1	IGMP Version 1 (not supported)
V2	2	IGMP Version 2
V3	3	IGMP Version 3 (Default version if this attribute is not set)

**VSA 26-50058-74 - RtBrick-IGMP-Max-Members**

This integer attribute can specify the number of parallel streaming (maximum IGMP membership) for a subscriber.



The CLI command `show subscriber <id> igmp` displays those information.

```

supervisor@rtbrick: op> show subscriber 72339069014638706 igmp
Subscriber-Id: 72339069014638706
  Interface: ifp-0/0/1
  Outer VLAN: 128
  Inner VLAN: 7
  IFL: ppp-0/0/3/72339069014638706
  State: active
  Version: IGMPv3
  Profile: iptv-basic
  Max Members: 6
    
```

The states are `active`, `inactive` and `disabled`. The state is `inactive` if IGMP is enabled but the IPv4 protocol state is not active.

## RADIUS Connection Status Message Attribute

### *VSA 26-50058-139 - RtBrick-Connection-Status-Message*

This attribute allows to send a connection status message string via PPP LCP vendor extension (RFC2513) to the client.

The connection status message is typically used to inform clients about the available bandwidth via RADIUS access-accept or CoA request.

```
RtBrick-Connection-Status-Message = <string>
```

Adding or changing the connection status message triggers to send a LCP vendor specific packet with OUI set to `f4:1e:5e` (RtBrick Inc.) and kind `0x01`.

### *RFC 2513 - Vendor Specific Packet*

```

0 1 2 3 4 5 6 7 8 9 0 1 2 3 4 5 6 7 8 9 0 1 2 3 4 5 6 7 8 9 0 1
+-----+-----+-----+-----+-----+-----+-----+-----+
|   Code   | Identifier |           Length           |
+-----+-----+-----+-----+-----+-----+
|                                     Magic-Number                                     |
+-----+-----+-----+-----+-----+-----+
|                                     OUI                                     | Kind |
+-----+-----+-----+-----+-----+-----+
| Value(s) ... |
+-----+-----+-----+
    
```

The value is encoded as TLV with type set to `0x01` and length including type and length field.

The actual status message string is limited to 247 bytes.

### Connection-Status-Message Option

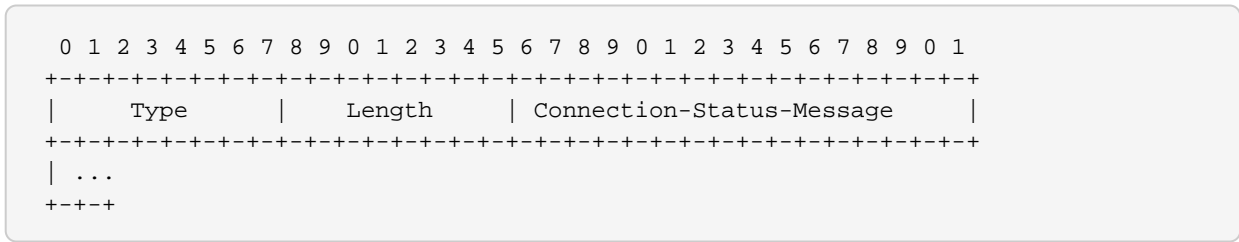

PPP clients with support for connection status message will respond with a vendor specific packet of kind **0x02** and the same OUI but no value to acknowledge the packet. All other clients either ignore or reject the message using PPP LCP code reject.

The connection status message will be retried 10 times with an interval of 3 seconds until the client has acknowledged or rejected the packet.

The status of the connection status message can be verified with the following command.

```

supervisor@leaf1: op> show pppoe session 72339069014638706 detail
Subscriber-Id: 72339069014638706
  State: ESTABLISHED
  Uptime: Mon Sep 13 09:29:42 GMT +0000 2021 (0:14:57.625027)
  Interface: ifp-0/0/1
  Outer VLAN: 128
  Inner VLAN: 7
...
  PPP LCP:
    State: OPENED
    Negotiated Protocols: PAP, IPCP, IP6CP
    Negotiated Parameters: MRU, AUTH, MAGIC
    Magic Number: 130827225 Peer: 2835676915
    MRU: 1492 Peer: 1492
    Echo Interval: 30 seconds
  PPP LCP Connection Status Message:
    State: ACCEPTED
    Message: SRU=10000#SRD=10000#
...
    
```

## RADIUS Ascend-Data-Filter Attribute

### VSA 26-529-242 - Ascend-Data-Filter

The Ascend-Data-Filter attribute describes per subscriber filter terms in a simple binary format as described in the following table. Multiple of those attributes in a

single RADIUS access-accept or CoA request message are combined to a dynamic filter where each attribute itself is one filter term. The order of those attributes in the RADIUS message is used to order the corresponding terms in the filter. This means that the first filter in the RADIUS packet has priority over the next and or last filter in the RADIUS packet.

Changes in such a filter via CoA requires that all attributes of the new filter must be sent. Therefore adding a single filter term requires sending the existing filter terms plus the new one or general speaking sending the intended target filter.

This filter is installed as a global packet filter placed before policer in ingress and before scheduler in egress to prevent that traffic dropped here is counted in accounting or consuming rate credits.

Field	Bytes	Values	Comments
Type	1	0 = ignore 1 = IPv4 3 = IPv6	
Action	1	0 = discard 1 = accept 0x20 = redirect	
Direction	1	0 = egress 1 = ingress	
Reserved	1	0	
Source Address	IPv4 = 4 IPv6 = 16	source address	Match on source address is not supported for filters in ingress direction and automatically replaced with the subscriber addresses.

<b>Field</b>	<b>Bytes</b>	<b>Values</b>	<b>Comments</b>
Destination Address	IPv4 = 4  IPv6 = 16	destination address	Match on destination address is not supported for filters in egress direction and automatically replaced with the subscriber addresses.
Source Prefix Length	1	0 = ignore  prefix length	The number of leading one bits in the source address mask. Specifies the bits of interest.
Destination Prefix Length	1	0 = ignore  prefix length	The number of leading one bits in the destination address mask. Specifies the bits of interest.
Protocol	1	0 = ignore  IPv4 protocol number  IPv6 next header	
Reserved	1	0	
Source Port	2	port number	UDP/TCP source port in network byte order (big endian)
Destination Port	2	port number	UDP/TCP destination port in network byte order (big endian)

Field	Bytes	Values	Comments
Source Port Qualifier	1	0 = no compare 1 = less than 2 = equal to 3 = greater than 4 = not equal to	The options 1, 3 and 4 are not implemented and mapped to 0 if received.
Destination Port Qualifier	1	0 = no compare 1 = less than 2 = equal to 3 = greater than 4 = not equal to	The options 1, 3 and 4 are not implemented and mapped to 0 if received.
Not Used	0 - N	0	Trailing bytes after destination port qualifier ignored.

The filter can be deleted dynamically by sending a single Ascend-Data-Filter attribute with a zero value.

Example:

```
Ascend-Data-Filter =
0x010001000000000000a0afffe00200000000000000000000000000000000000000000000000

01      IPv4          // type
00      discard      // action
01      ingress      // direction
00      -            // reserved
00000000 -          // source address
0a0afffe 198.51.100.101 // destination address
00      -            // source prefix length
20      /32         // destination prefix length
00      -            // protocol
00      -            // reserved
0000    -            // source port
0000    -            // destination port
00      -            // source port qualifier
00      -            // destination port qualifier
00000... -          // ignored
```



For ingress filters, it is not permitted to match based on the source address which is automatically replaced with the subscriber addresses. A similar limitation is valid for egress filters matching on destination address which is also replaced with subscriber addresses.



A new proprietary filter action **0x20 (32)** is added for the redirect service. This can be used to enable HTTP Redirect for a subscriber using the ADF.

All active subscriber filters are stored in the table **global.access.1.subscriber.filter** to hand over that information to the forwarding infrastructure. This table can be also used to verify the filters which are active for a given subscriber.

The CLI command **show subscriber <id> acl** displays those filters in a nice human-readable format.

## RADIUS Access Line Attributes

The access line identification and characterization information are defined in the Broadband Forum (BBF) formerly known DSL Forum attributes including Agent-Remote-Id and Agent-Circuit-Id.

See the following references for more information about access line attributes.

- RFC 4679 DSL Forum Vendor-Specific RADIUS Attributes
- RFC 6320 ANCP
- Broadband Forum TR-101
- draft-lihawi-ancp-protocol-access-extension-04

Those attributes will be sent in RADIUS access and accounting requests to the RADIUS server if learned from the underlying access protocol like PPPoE (BBF TR-101).

RBFS also provides the possibility to set those values via RADIUS by using the same attributes in the RADIUS access-accept or CoA request message.

*Access Line Attributes Supported (RADIUS, PPPoE and L2TP):*

<b>Attribute</b>	<b>Name</b>
26-3561-1	Agent-Circuit-Id
26-3561-2	Agent-Remote-Id
26-3561-18	PON-Access-Line-Attributes
26-3561-129	Actual-Data-Rate-Upstream
26-3561-130	Actual-Data-Rate-Downstream
26-3561-131	Minimum-Data-Rate-Upstream
26-3561-132	Minimum-Data-Rate-Downstream
26-3561-133	Attainable-Data-Rate-Upstream
26-3561-134	Attainable-Data-Rate-Downstream
26-3561-135	Maximum-Data-Rate-Upstream
26-3561-136	Maximum-Data-Rate-Downstream
26-3561-137	Minimum-Data-Rate-Upstream-Low-Power
26-3561-138	Minimum-Data-Rate-Downstream-Low-Power
26-3561-139	Maximum-Interleaving-Delay-Upstream
26-3561-140	Actual-Interleaving-Delay-Upstream
26-3561-141	Maximum-Interleaving-Delay-Downstream
26-3561-142	Actual-Interleaving-Delay-Downstream
26-3561-144	Access-Loop-Encapsulation
26-3561-145	DSL-Type
26-3561-151	PON-Access-Type
26-3561-155	Expected-Throughput-Upstream
26-3561-156	Expected-Throughput-Downstream
26-3561-157	Attainable-Expected-Throughput-Upstream
26-3561-158	Attainable-Expected-Throughput-Downstream

<b>Attribute</b>	<b>Name</b>
26-3561-159	Gamma-Data-Rate-Upstream
26-3561-160	Gamma-Data-Rate-Downstream
26-3561-161	Attainable-Gamma-Data-Rate-Upstream
26-3561-162	Attainable-Gamma-Data-Rate-Downstream
26-3561-176	ONT-ONU-Average-Data-Rate-Downstream
26-3561-177	ONT-ONU-Peak-Data-Rate-Downstream
26-3561-178	ONT-ONU-Maximum-Data-Rate-Upstream
26-3561-179	ONT-ONU-Assured-Data-Rate-Upstream
26-3561-180	PON-Tree-Maximum-Data-Rate-Upstream
26-3561-181	PON-Tree-Maximum-Data-Rate-Downstream

This table includes already the new attributes defined in draft-lihawi-ancp-protocol-access-extension-04 which results in possible changes in case the draft is updated.

Changes in at least one of those line attributes via CoA trigger a RADIUS interim accounting request with the new values.

Changes in actual data rate upstream/downstream via CoA request may trigger the L2TP LAC to send a CSUN request with updated connection speed to the LNS depending on the actual L2TP configuration.

## **RADIUS L2TP**

Tunneling of PPPoE sessions via L2TPv2 (L2TP LAC) is supported on RBFS and can be controlled via RADIUS as described in RFC 2868 RADIUS Attributes for Tunnel Protocol Support with some limitations:

- No support of FQDN format for IP addresses
- No support Tunnel-Medium-Type other than IPv4



To establish a PPPoE session via L2TP, the tunnel-type must be configured as L2TP. This configuration can be achieved either for local users or by utilizing the corresponding tunnel-type attribute through RADIUS.

Defining an L2TP configuration profile is essential, which can be referenced through an access configuration profile or by employing the appropriate RADIUS VSA. The actual tunnels may either be defined locally via an L2TP pool configuration or set up dynamically through RADIUS.

```
# FreeRADIUS
# RADIUS authenticated with local defined tunnels.
"radius@l2tp" Cleartext-Password := "test"
    Service-Type = Framed-User,
    Framed-Protocol = PPP,
    Tunnel-Type:0 = L2TP

# RADIUS authenticated with dynamic tunnels.
"tunnel@rl2tp" Cleartext-Password := "test"
    Service-Type = Framed-User,
    Framed-Protocol = PPP,
    Tunnel-Type:1 = L2TP,
    Tunnel-Client-Endpoint:1 = "192.0.2.1",
    Tunnel-Server-Endpoint:1 = "192.0.2.2",
    Tunnel-Client-Auth-Id:1 = "bng",
    Tunnel-Server-Auth-Id:1 = "lns",
    Tunnel-Preference:1 = 100,
    Tunnel-Password:1 = "test",
    Tunnel-Type:2 += L2TP,
    Tunnel-Client-Endpoint:2 += "192.0.2.3",
    Tunnel-Server-Endpoint:2 += "192.0.2.4",
    Tunnel-Client-Auth-Id:2 += "BNG",
    Tunnel-Server-Auth-Id:2 += "LNS2",
    Tunnel-Preference:2 += 200,
    Tunnel-Password:2 += "test"
```

In addition to the standard attributes, the following vendor-specific attributes are supported for L2TP.



RFC and draft compliance are partial except as specified.

### ***VSA 26-50058-40 - RtBrick-L2TP-Pool***

Instead of RADIUS tunnel attributes it is also possible to configure local L2TP tunnel pools and assign them with this attribute.

### ***VSA 26-50058-41 - RtBrick-L2TP-Profile***

The default L2TP configuration profile assigned in the access configuration profile can be changed in RADIUS access-accept to allow different L2TP configurations

based on tunnel endpoints. This is typically used to enable or disable L2TP CSUN updates (RFC5515).

### ***VSA 26-50058-42 - RtBrick-L2TP-Tx-Connect-Speed***

### ***VSA 26-50058-43 - RtBrick-L2TP-Rx-Connect-Speed***

Those attributes are supported in RADIUS access-accept and CoA requests to set the corresponding L2TP to connect speed values directly. Per default, the L2TP connect speed is derived from the actual data rate upstream/downstream of the configured source (PPPoE-IA or RADIUS) if present or set to port speed which can be overridden with the connect speed attributes. Changes in connect speed via CoA request will trigger the L2TP LAC to send a CSUN request to the LNS if enabled.

Those two attributes are defined as 4-byte integers with speed defined in kbits.

## **RADIUS Lawful Interception**

Lawful interception (LI) refers to the facilities in telecommunications and telephone networks that allow law enforcement agencies (LEA) with court orders or other legal authorization to selectively intercept individual subscribers. The term mediation device (MED) used in this document describes the element which receives and optionally converts the intercepted traffic into the format expected by the law enforcement agencies of the corresponding countries.

All of the following attributes must be present in RADIUS access-accept or CoA request to control lawful interception (LI) via RADIUS. Those attributes are salt encrypted using the algorithm described in RFC 2868 for the Tunnel Password. This encryption algorithm is defined for RADIUS access-accept messages only. To support CoA requests the request authenticator should be replaced with 16 zero bytes which is common industry standard.

The LI action NOOP can be used to obfuscate lawful interception requests (fake requests) to prevent just the presence of those attributes indicating that a subscriber is intercepted. LI requests via RADIUS will show up in the same table as requests via REST or HTTP RPC API (global.access.1.li\_request).



Failed LI activations are not signaled via RADIUS to prevent that just the presence of CoA response NAK shows that LI request is not fake (action NOOP).

**VSA 26-50058-140 - RtBrick-LI-Action (salt encrypted integer)**

Value	Code	Description
NOOP	0	No action / Ignore LI request
ON	1	Start LI / Add LI request
OFF	2	Stop LI / Delete LI request

**VSA 26-50058-141 - RtBrick-LI-Identifier (salt encrypted integer)**

Device unique lawful interception identifier (LIID) within the range from 1 to 4194303.

**VSA 26-50058-142 - RtBrick-LI-Direction (salt encrypted integer)**

Value	Code	Description
INGRESS	1	Ingress mirroring only (from subscriber)
EGRESS	2	Egress mirroring only (to subscriber)
BOTH	3	Bidirectional mirroring (from and to subscriber)

**VSA 26-50058-143 - RtBrick-LI-MED-Instance (salt encrypted string)**

Routing instance through which the mediation device is reachable.

**VSA 26-50058-144 - RtBrick-LI-MED-IP (salt encrypted IPv4 address)**

IPv4 address of the mediation device.

**VSA 26-50058-145 - RtBrick-LI-MED-Port (salt encrypted integer)**

UDP port between 49152 and 65535 are set in the mirrored traffic.

**RADIUS Framed Routes**

The framed-route attributes are used by the RADIUS to install specific routes for a given subscriber. The corresponding next-hop information is automatically derived

from the subscriber context. This functionality is typically used to route additional customer networks through the client device (CPE).

Those attributes are supported via RADIUS access-accept only. Each of those attributes may occur multiple times to install various routes. The actual amount of routes supported is limited by the maximum RADIUS packet size only.

The framed-route attributes are defined in RFC 2865 for IPv4 and RFC 3162 for IPv6 but the actual content of those attributes is implementation dependent. RBFS is expecting a string with a prefix followed by prefix length. The prefix can be followed by further routing options like costs, metric or even next-hop which are currently ignored.

### ***Attribute 22 - Framed-Route***

```
Framed-Route = "198.51.100.69/24"
```

### ***Attribute 99 - Framed-IPv6-Route***

```
Framed-IPv6-Route = "2001:db8:0:90::/32"
```

## **RADIUS Subscriber ACLs (Filters)**

The subscriber ACL attributes are used by the RADIUS server to install a specific ACL, which has already been configured in the BNG, for a subscriber. For information about Subscriber ACL Configuration see 'Subscriber ACLs and HTTP Redirect Service' guide. After the Subscriber ACLs are configured with the name and the rules, use the following RADIUS attributes dynamically for adding or changing those ACLs from RADIUS. These attributes are supported in **access-accept** and **CoA**.

The subscriber ACL attributes are used by the RADIUS server to install a specific ACL, which has already been configured in the BNG, for a subscriber. For information about Subscriber ACL Configuration, see the 'Subscriber ACLs and HTTP Redirect Service' guide. After the Subscriber ACLs are configured with the name and the rules, use the following RADIUS attributes to add or change those ACLs from RADIUS. These attributes are supported in **access-accept** and **CoA**.

When a CoA is issued with one of those ACL attributes or a service profile, it will always reset all existing filters, even if the new service profile does not define any

filters. If there are filters specified within the service profile along with subscriber ACL attributes, these subscriber ACL attributes take precedence. The filters are merged by first applying all the filters from the service profile and then adding or replacing filters using the attributes defined here. The final resulting filter set is then applied to the subscriber.

Filters that were applied first but are not defined in the new set will be deleted. Consequently, adding a single filter via CoA will remove all other existing filters. This approach is designed to provide a more declarative way of defining the desired target state without depending on the existing state.

- **VSA 26-50058-76 - RtBrick-IPv4-ACL-In**

```
Attach IPv4 subscriber ingress ACL (ACL in upstream direction)
```

- **VSA 26-50058-77 - RtBrick-IPv4-ACL-Out**

```
Attach IPv4 subscriber ingress ACL (ACL in downstream direction)
```

- **VSA 26-50058-78 - RtBrick-IPv6-ACL-In**

```
Attach IPv6 subscriber ingress ACL (ACL in upstream direction)
```

- **VSA 26-50058-79 - RtBrick-IPv6-ACL-Out**

```
Attach IPv6 subscriber egress ACL (ACL in downstream direction)
```

Example:

```
RtBrick-IPv4-ACL-In = "ipoe-sub1-http-acl"
```

To detach any of the preceding ACLs and to delete the ACL associated with a subscriber, **null** string can be used with the corresponding attribute.

Example:

```
RtBrick-IPv4-ACL-In = ""
```

## RADIUS HTTP Redirect URL

When HTTP Redirect is enabled for a subscriber either through Ascend-Data-Filter or through the subscriber ACLs, HTTP packets from the subscriber get redirected to the URL set by this attribute:

### ***VSA 26-50058-75 - RtBrick-HTTP-Redirect-URL***

This attribute is supported on RADIUS **access-accept** and **CoA** requests. This attribute allows the overwriting of the URL.

For example:

RtBrick-HTTP-Redirect-URL = "http://portal.rtbrick.com"

To reset the URL:

RtBrick-HTTP-Redirect-URL = ""

## RADIUS Terminate Codes

### ***VSA 26-50058-27 - RtBrick-Terminate-Code***

The RtBrick-Terminate-Code is sent along with the standard Acct-Terminate-Cause (attribute 49). The list below shows the RtBrick termination codes with the mapping to the standard cause.

<b>RtBrick-Terminate-Code</b>	<b>Acct-Terminate-Cause (RADIUS Attribute 49)</b>	<b>Description</b>
0	10 (NAS Request)	NA
1	10 (NAS Request)	Subscriber Management Unknown Error
2	9 (NAS Error)	SubscriberD Internal Error
3	9 (NAS Error)	PPPoED Internal Error

<b>RtBrick-Terminate-Code</b>	<b>Acct-Terminate-Cause (RADIUS Attribute 49)</b>	<b>Description</b>
4	9 (NAS Error)	PPPoED Object Deleted <i>This code is used if an PPPoE session object is deleted which is an indication for a crash or some other issues in PPPoE daemon.</i>
5	9 (NAS Error)	L2TPD Internal Error
6	9 (NAS Error)	L2TPD Object Deleted <i>This code is used if an L2TP session object is deleted which is an indication for a crash or some other issues in L2TP daemon.</i>
7	9 (NAS Error)	AAA Profile Not Found
8	9 (NAS Error)	RADIUS Profile Not Found
9	9 (NAS Error)	Authentication Type Missing
10	9 (NAS Error)	Authentication Order Missing or Invalid
11	10 (NAS Request)	Authentication Failure
12	10 (NAS Request)	Local Authentication Failed
13	10 (NAS Request)	Accounting-Request-On Wait
14	9 (NAS Error)	No RADIUS Authentication Server Configured
15	10 (NAS Request)	RADIUS Authentication Failed
16	17 (User Error)	Authentication Rejected
17	17 (User Error)	Local Authentication Rejected
18	17 (User Error)	RADIUS Authentication Rejected
19	5 (Session Timeout)	Session Timeout
20	4 (Idle Timeout)	Idle Timeout
21	6 (Admin Reset)	Clear Session

<b>RtBrick-Terminate-Code</b>	<b>Acct-Terminate-Cause (RADIUS Attribute 49)</b>	<b>Description</b>
22	6 (Admin Reset)	RADIUS CoA Disconnect
23	9 (NAS Error)	PPPoE Unknown Error
24	1 (User Request)	PPPoE PADT Received
25	9 (NAS Error)	PPPoE LCP Error
26	10 (NAS Request)	PPPoE LCP Generic Error
27	1 (User Request)	PPPoE LCP Terminate Request Received
28	10 (NAS Request)	PPPoE LCP Maximum Reject / NAK Exceeded
29	10 (NAS Request)	PPPoE LCP Negotiation Failed
30	10 (NAS Request)	PPPoE LCP Configuration-Request Exceeded
31	10 (NAS Request)	PPPoE LCP Echo-Request Timeout Exceeded
32	9 (NAS Error)	PPPoE PAP Error
33	9 (NAS Error)	PPPoE CHAP Error
34	9 (NAS Error)	PPPoE IPCP Error
35	9 (NAS Error)	PPPoE IP6CP Error
36	9 (NAS Error)	PPPoE NCP Initialization Failed
37	10 (NAS Request)	PPPoE NCP Down
38	6 (Admin Reset)	PPPoE Clear Session
39	10 (NAS Request)	PPPoE Upper Layer Down
40	8 (Port Error)	PPPoE Interface Down
41	10 (NAS Request)	PPPoE Configuration Deleted
42	9 (NAS Error)	PPPoE Access Configuration Profile Not Found
43	9 (NAS Error)	L2TP Unknown Error
44	10 (NAS Request)	L2TP Tunnel Down
45	10 (NAS Request)	L2TP Tunnel Dead



<b>RtBrick-Terminate-Code</b>	<b>Acct-Terminate-Cause (RADIUS Attribute 49)</b>	<b>Description</b>
46	10 (NAS Request)	L2TP Tunnel Deleted
47	10 (NAS Request)	L2TP No Tunnel Available
48	10 (NAS Request)	L2TP CDN Request
49	9 (NAS Error)	L2TP Profile Not Found
50	9 (NAS Error)	L2TP Access Configuration Profile Not Found
51	9 (NAS Error)	L2TP No Tunnel Pool Error
52	9 (NAS Error)	L2TP Local Tunnel Pool Error
53	9 (NAS Error)	L2TP RADIUS Tunnel Pool Error
54	6 (Admin Reset)	L2TP Clear Session
55	9 (NAS Error)	Access Configuration Profile Not Found
56	9 (NAS Error)	Local IPv4 Address Pool Not Found
57	10 (NAS Request)	Local IPv4 Address Pool Exhausted
58	9 (NAS Error)	Local IPv6 Prefix Pool Not Found
59	10 (NAS Request)	Local IPv6 Prefix Pool Exhausted
60	9 (NAS Error)	Local IPv6 Delegated Prefix Pool Not Found
61	10 (NAS Request)	Local IPv6 Delegated Prefix Pool Exhausted
62	10 (NAS Request)	PPPoE CHAP Response Timeout
63	10 (NAS Request)	L2TP Session Deleted
64	10 (NAS Request)	Duplicate IPv4 address detected
65	10 (NAS Request)	Duplicate IPv6 prefix detected

<b>RtBrick-Terminate-Code</b>	<b>Acct-Terminate-Cause (RADIUS Attribute 49)</b>	<b>Description</b>
66	10 (NAS Request)	Duplicate delegated IPv6 prefix detected
67	9 (NAS Error)	Routing instance not found
68	6 (Admin Reset)	Clear Session Force
69	6 (Admin Reset)	Test AAA Request Object Deleted
70	9 (NAS Error)	IPoED Object Deleted <i>This code is used if an IPoE subscriber object is deleted which is an indication for a crash or some other issues in IPoE daemon.</i>
71	9 (NAS Error)	IPoED Internal Error
72	9 (NAS Error)	IPoE Unknown Error
73	10 (NAS Request)	IPoE Upper Layer Down
74	10 (NAS Request)	IPoE Lower Layer Down
75	10 (NAS Request)	IPoE Interface Down
76	10 (NAS Request)	IPoE Configuration Deleted
77	10 (NAS Request)	SubscriberD Request
78	10 (NAS Request)	L2BSA Service Deleted
79	10 (NAS Request)	L2BSA Service Added
80	6 (Admin Reset)	IPoE Clear Subscriber
81	6 (Admin Reset)	PPPoE Clear Session Force
82	9 (NAS Error)	IPoE Invalid Gateway IFL
83	9 (NAS Error)	FWD Invalid
84	9 (NAS Error)	FWD Failed
85	9 (NAS Error)	FWD Deleted
86	10 (NAS Request)	Instance Deleted
87	10 (NAS Request)	Redundancy Switchover

<b>RtBrick-Terminate-Code</b>	<b>Acct-Terminate-Cause (RADIUS Attribute 49)</b>	<b>Description</b>
88	10 (NAS Request)	Redundancy Active Node Termination
89	10 (NAS Request)	Redundancy Active Node Down
90	9 (NAS Error)	Redundancy Invalid State
91	9 (NAS Error)	Redundancy Invalid State for Sync
92	9 (NAS Error)	Redundancy Validation Failed
93	10 (NAS Request)	Redundancy Config Deleted
94	9 (NAS Error)	Redundancy Stale Timer Expiry
95	9 (NAS Error)	IPv4 In ACL Validation Failed
96	9 (NAS Error)	IPv4 Out ACL Validation Failed
97	9 (NAS Error)	IPv6 In ACL Validation Failed
98	9 (NAS Error)	IPv6 Out ACL Validation Failed
99	9 (NAS Error)	IP Address Allocation Failed
100	9 (NAS Error)	No IP Address  <i>This code is used if a forwarding subscriber object is deleted which is an indication of a crash or some other issues in the forwarding infrastructure.</i>

It is recommended to raise operational alarms for every termination cause received with a value of 9 (NAS Error) for further investigations.

## **RADIUS CoA Error Handling**

CoA requests should be retried a few times in the unlikely event of CoA NAK with error-cause (RFC 5176 attribute 101) other than session-context-not-found (503) or missing-attribute (402). There is no rollback of failed CoA requests to the former state but retrying the same request is supported because changes are implemented in a more declarative way.

## 5.2.4. RADIUS Accounting

RADIUS accounting servers handle accounting records for subscribers. The subscriber daemon transmits RADIUS Accounting-Start, Interim and Stop messages to these servers. Accounting is the process of tracking subscriber activity and network resource usage in a subscriber session. This includes the session time called time accounting and the number of packets and bytes transmitted during the session called volume accounting.

A RADIUS Acct-Status-Type attribute is used by the RADIUS client (subscriber daemon) to mark the start of accounting (for example, upon booting) by specifying Accounting-On and to mark the end of accounting (for example, just before a scheduled reboot) by specifying Accounting-Off. This message is often used by RADIUS servers to automatically close/terminate all open accounting records/sessions for the corresponding client and therefore must not be sent to servers belonging to a profile which was already used/started for accounting.

Per default, the assumption is that all servers referenced by a RADIUS profile share the same states and therefore accounting-on must be only sent to one of those before the first accounting-start is sent.

RADIUS Accounting-On/Off messages are disabled by default and can be optionally enabled in the RADIUS profile configuration. There is also an additional configuration option to optionally wait for Accounting-On response which prevents any new session until accounting has started meaning that Accounting-On response is received.



| Accounting-Off is currently not implemented!

RADIUS accounting requests are often used for billing and therefore should be able to store and retry over a longer period (common up to 24 hours or more) which can be optionally enabled in the RADIUS profile configuration using the accounting backup configuration option.

### Time Accounting

All accounting relevant timestamps are retrieved using the UNIX system call [clock\\_gettime](#) internally stored in the datastore as 64 bit microseconds timestamp with the lower order 32 bit representing the seconds since January 1, 1970 00:00 UTC which is also known as epoch or unix timestamp and the higher order 32 bit

representing the microseconds which are per definition less than 1.000.000 (one second). The seconds part is counted in full seconds which is similar to always rounded down.

The RADIUS attribute event-timestamp (type 55) defined in [RFC2869](#) is included in each RADIUS Accounting-Request packet to record the time that this event occurred in seconds since January 1, 1970 00:00 UTC. A max allowed deviation of 500 milliseconds of a timestamp in seconds requires mathematical rounding of the internal 64 bit microseconds timestamps to the 32 bit RADIUS event-timestamp in seconds. This means to round down if the microseconds part of the timestamp is less than 0.5 seconds and rounded up if equal or greater than 0.5 seconds.

### ***Start Timestamps***

In RBFS the timestamp indicating the PPPoE session start will be generated after successful negotiation of at least one of the PPP network control protocols (IPCP for IPv4 or IP6CP for IPv6). In case of L2TP tunneled sessions (LAC), the successful L2TP session setup after sending ICCN is used as a start timestamp. In both cases this is also the trigger for the RADIUS accounting-request start where this timestamp is used as RADIUS event-timestamp.

### ***Stop Timestamps***

The timestamp indicating the session stop will be generated more or less immediately after termination request (e.g. timeout, user request, nas request, ...).

The RADIUS attribute Acct-Session-Time (type 46) defined in [RFC2866](#) indicates how many seconds the user has received service and can only be present in Accounting-Request records where the Acct-Status-Type is set to Interim or Stop. This time will be calculated based on the internal session start and stop time in microseconds and mathematical rounded to seconds. For RADIUS accounting interim requests the current event time is used instead of stop time.



| RFC and draft compliance are partial except as specified.

## **Volume Accounting**

Based on §45g of the German Telecommunications Act (TKG), the maximum deviation for accounting relevant counters must be less than 1% per billing period which is typically one month.

The whole RBFS architecture is based on an event-based publish and subscribe model using the BDS infrastructure. Each process publishes all information and states to BDS and interested processes subscribe to that information. The whole inter process communications (IPC) is replaced by BDS table operations which allows to build a hyper scaled distributed software system. This means related to accounting that each counter is requested from data plane and updated in BDS unsolicited based on configurable intervals typically set between 5 to 30 seconds. This applies to any type of counters like interface counters or QoS statistics. This means that CLI commands or API requests will return the last updated counter and not the counter of the time of request. Therefore each BDS object contains a timestamp indicating the time of the last counter update which allows to use these counters with the required accuracy.

Subscriber volume accounting is based on multiple sources like logical interface (LIF), class/queue-, policer- and control-traffic statistics.

All those counters are layer 2 (L2) counters and some of them may reset through configuration changes like QoS counters after applying a new QoS profile. Therefore the subscriber management application daemon is doing some post processing of all counters to ensure that no accounting information is lost and to calculate the final accounting values. This includes also optional configurable counter adjustments.

There is a BDS database object in the table **local.access.subscriber.accounting** created for each subscriber which stores all counters and attributes required to calculate the actual volume counters. This object is created together with the subscriber and automatically deleted if the actual subscriber object is removed.

The volume accounting counters must not reset if the actual hardware counter is deleted or has changed/reset to zero. Therefore instead of using the source counter directly, the delta since the last interval is calculated and added to the final counter.

The usage of callback functions to counter delete and change events ensures that no accounting relevant information will be lost through reconfiguration of subscriber sessions.

The function which removes the subscriber counters from the data plane will receive the final counters before removal and update them into BDS counter objects before this is deleted.

### ***Interims Volume Counters***

RADIUS accounting interim requests will also use the last updated counters with current time as event-timestamp.

### ***Stop Volume Counters***

The session termination might be triggered by REST API, CLI (clear subscriber ...) RADIUS CoA disconnect request, session timeout, idle timeout or client request (PADT). The corresponding RADIUS accounting stop requests will be delayed to wait for the final counter update but uses the timestamp of the terminate request.

### **Interims Accounting**

To receive RADIUS counters in fast intervals the corresponding session interim accounting interval can be set depending on the actual needs to any value between one second and multiple hours or days (recommended is at least 30 seconds). This interval can be also updated via CoA request using the Acct-Interim-Interval attribute which triggers an interim accounting immediately and uses the new interval from now onwards. This can be also used to request interim accounting requests on demand. Sending a CoA request with the applied interval triggers an accounting request but the original interval is not changed.

## **5.2.5. RADIUS Counters**

The packets and byte counters of each session, traffic class (class 0 - 7) as well as policer counters (level 1 to 4) are supported via RADIUS accounting interims and stop messages. Those counters are layer two counters per default which can be adjusted using correction values and factors from the AAA configuration profile.

Subscriber accounting is based on multiple sources like LIF-, class/queue-, policer- and control-traffic statistics which are described below.

- The InLIF (Incoming Logical Interface) stats count all traffic received on the logical interface including control traffic are traffic dropped by ingress policer.
- The policer stats count all traffic accepted by policer (color green) per level (1-4). Ingress control traffic will be hit by a separate control plane policer and therefore not counted in the session policer stats.
- The class/queue stats count all egress traffic except control traffic which is directly sent to the IFP.

- The OutLIF (Outgoing Logical Interface) stats count all traffic sent on the logical interface except control traffic which is directly sent to the IFP.
- The control stats count all traffic received and sent from or to the control plane for a given subscriber (counted in PPPoE daemon for PPPoE sessions).

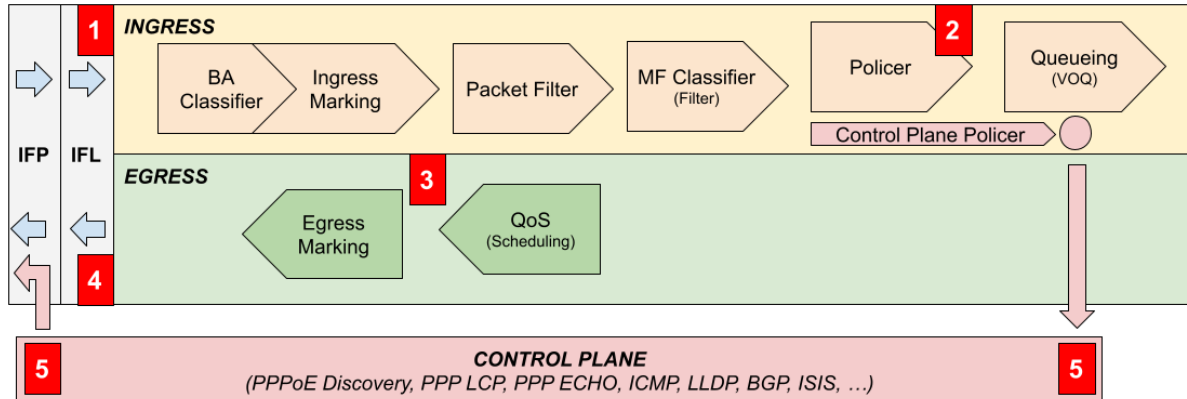

Because counter updates are not atomic operations, the sum of all class counters might be different from the session counters.

The counted bytes per packet can be adjusted as described in chapter Configuring Accounting Adjustments of the Subscriber Management Configuration Guide.

All subscriber accounting attributes and counters are stored without adjustment (L2) in the table **local.access.subscriber.accounting** and remain until the subscriber session is finally removed after response to RADIUS accounting stop.

The command `show subscriber <id> accounting` displays the adjusted subscriber accounting information. It is also possible to display the values before adjustment using `show subscriber <id> accounting origin`.

```

supervisor@rtbrick: op> show subscriber 72339069014638637 accounting
Subscriber-Id: 72339069014638637
IFL: ppp-0/0/1/72339069014638637
Start Timestamp: Wed Feb 24 09:06:47 GMT +0000 2021
Idle Timestamp: Wed Feb 24 09:06:47 GMT +0000 2021
Session-Timeout: 86400 seconds
Idle-Timeout: 7200 seconds
Session Statistics:
  Ingress: 0 packets 0 bytes
  Egress: 0 packets 0 bytes
LIF Statistics:
  Ingress: 14 packets 896 bytes
  Egress: 0 packets 0 bytes
Egress Class (Queue) Statistics:
  class-0: 0 packets 0 bytes
  class-1: 0 packets 0 bytes
    
```



```

class-2: 0 packets 0 bytes
class-3: 0 packets 0 bytes
class-4: 0 packets 0 bytes
class-5: 0 packets 0 bytes
class-6: 0 packets 0 bytes
class-7: 0 packets 0 bytes
Ingress Policer Statistics:
Level 1: 0 packets 0 bytes
Level 2: 0 packets 0 bytes
Level 3: 0 packets 0 bytes
Level 4: 0 packets 0 bytes

```

## Session Counters

Per default, the session counters are calculated using the LIF statistics which include all traffic received on the logical interface (InLIF) and all traffic sent on the logical interface (OutLIF) except control traffic which is directly sent to the IFP. Ingress traffic sent to CPU or transit traffic dropped by policer is still counted whereas egress traffic dropped by QoS is not counted.

Alternatively, it is possible to use the sum of all policer counters for ingress session counters which can be changed in the AAA configuration profile by setting the accounting ingress source to POLICER (default is LIF) to include only accepted transit traffic.

Using LIF in egress and POLICER in ingress results in a symmetric behavior where only accepted transit traffic is counted.

Following the list of the RtBrick class counter attributes.

Attribute	Name	Description
42	Acct-Input-Octets	Incoming session bytes (uint32)
43	Acct-Output-Octets	Outgoing session bytes (uint32)
47	Acct-Input-Packets	Incoming session packets (uint32)
48	Acct-Output-Packets	Outgoing session packets (uint32)
52	Acct-Input-Gigawords	Acct-Input-Octets overflow counter (uint32)
53	Acct-Output-Gigawords	Acct-Output-Octets overflow counter (uint32)

The internal 64 bit counters are split over the standard 32 bit octet and gigaword

counters by using the most significant 32 bit as gigawords and the least significant 32 bits as octets.

<b>32 Bit Acct-Input/Output-Gigawords</b>	<b>32 Bit Acct-Input/Output-Octets</b>
Internal 64 Bit Counter	

## Class Counters

The outgoing class counters are filled by queue counters which ensures that only traffic leaving the device is counted here.

Following the list of the RtBrick class counter attributes.

Attribute	Name	Description
26-50058-81	RtBrick-Class-0-Packets-Out	Outgoing Class-0 packets (uint64)
26-50058-82	RtBrick-Class-0-Bytes-Out	Outgoing Class-0 bytes (uint64)
26-50058-83	RtBrick-Class-1-Packets-Out	Outgoing Class-1 packets (uint64)
26-50058-84	RtBrick-Class-1-Bytes-Out	Outgoing Class-1 bytes (uint64)
26-50058-85	RtBrick-Class-2-Packets-Out	Outgoing Class-2 packets (uint64)
26-50058-86	RtBrick-Class-2-Bytes-Out	Outgoing Class-2 bytes (uint64)
26-50058-87	RtBrick-Class-3-Packets-Out	Outgoing Class-3 packets (uint64)
26-50058-88	RtBrick-Class-3-Bytes-Out	Outgoing Class-3 bytes (uint64)
26-50058-98	RtBrick-Class-4-Packets-Out	Outgoing Class-4 packets (uint64)
26-50058-90	RtBrick-Class-4-Bytes-Out	Outgoing Class-4 bytes (uint64)

<b>Attribute</b>	<b>Name</b>	<b>Description</b>
26-50058-91	RtBrick-Class-5-Packets-Out	Outgoing Class-5 packets (uint64)
26-50058-92	RtBrick-Class-5-Bytes-Out	Outgoing Class-5 bytes (uint64)
26-50058-93	RtBrick-Class-6-Packets-Out	Outgoing Class-6 packets (uint64)
26-50058-94	RtBrick-Class-6-Bytes-Out	Outgoing Class-6 bytes (uint64)
26-50058-95	RtBrick-Class-7-Packets-Out	Outgoing Class-7 packets (uint64)
26-50058-96	RtBrick-Class-7-Bytes-Out	Outgoing Class-7 bytes (uint64)

Those attributes will be encoded as subattributes (RFC2865) similar to broadband forum (BBF) line attributes to reduce the size of the RADIUS message. Counters with a zero value will be also excluded from the packet.

- ▼ AVP: t=Vendor-Specific(26) l=246 vnd=RtBrick Inc.(50058)
  - Type: 26
  - Length: 246
  - Vendor ID: RtBrick Inc. (50058)
  - ▶ VSA: t=RtBrick-Class-0-Packets-Out(81) l=10 val=0000000000000000a
  - ▶ VSA: t=RtBrick-Class-0-Bytes-Out(82) l=10 val=000000000000003e8
  - ▶ VSA: t=RtBrick-Class-1-Packets-Out(83) l=10 val=0000000000000000b
  - ▶ VSA: t=RtBrick-Class-1-Bytes-Out(84) l=10 val=000000000000003e9
  - ▶ VSA: t=RtBrick-Class-2-Packets-Out(85) l=10 val=0000000000000000c
  - ▶ VSA: t=RtBrick-Class-2-Bytes-Out(86) l=10 val=000000000000003ea
  - ▶ VSA: t=RtBrick-Class-3-Packets-Out(87) l=10 val=0000000000000000d
  - ▶ VSA: t=RtBrick-Class-3-Bytes-Out(88) l=10 val=000000000000003eb
  - ▶ VSA: t=RtBrick-Class-4-Packets-Out(89) l=10 val=0000000000000000e
  - ▶ VSA: t=RtBrick-Class-4-Bytes-Out(90) l=10 val=000000000000003ec
  - ▶ VSA: t=RtBrick-Class-5-Packets-Out(91) l=10 val=0000000000000000f
  - ▶ VSA: t=RtBrick-Class-5-Bytes-Out(92) l=10 val=000000000000003ed
  - ▶ VSA: t=RtBrick-Class-6-Packets-Out(93) l=10 val=00000000000000010
  - ▶ VSA: t=RtBrick-Class-6-Bytes-Out(94) l=10 val=000000000000003ee
  - ▶ VSA: t=RtBrick-Class-7-Packets-Out(95) l=10 val=00000000000000011
  - ▶ VSA: t=RtBrick-Class-7-Bytes-Out(96) l=10 val=000000000000003ef
  - ▶ VSA: t=RtBrick-Policer-L1-Packets-In(97) l=10 val=00000000000000015
  - ▶ VSA: t=RtBrick-Policer-L1-Bytes-In(98) l=10 val=000000000000007d1
  - ▶ VSA: t=RtBrick-Policer-L2-Packets-In(99) l=10 val=00000000000000016
  - ▶ VSA: t=RtBrick-Policer-L2-Bytes-In(100) l=10 val=000000000000007d2
  - ▶ VSA: t=RtBrick-Policer-L3-Packets-In(101) l=10 val=00000000000000017
  - ▶ VSA: t=RtBrick-Policer-L3-Bytes-In(102) l=10 val=000000000000007d3
  - ▶ VSA: t=RtBrick-Policer-L4-Packets-In(103) l=10 val=00000000000000018
  - ▶ VSA: t=RtBrick-Policer-L4-Bytes-In(104) l=10 val=000000000000007d4

## Policer Counters

The incoming policer attributes count all traffic accepted (colored green) by ingress policers with dedicated packet and byte values per level.

Following the list of the RtBrick policer counter attributes.

Attribute	Name	Description
26-50058-97	RtBrick-Policer-L1-Packets-In	Incoming Policer L1 accepted packets (uint64)
26-50058-98	RtBrick-Policer-L1-Bytes-In	Incoming Policer L1 accepted bytes (uint64)
26-50058-99	RtBrick-Policer-L2-Packets-In	Incoming Policer L2 accepted packets (uint64)
26-50058-100	RtBrick-Policer-L2-Bytes-In	Incoming Policer L2 accepted bytes (uint64)

Attribute	Name	Description
26-50058-101	RtBrick-Policer-L3-Packets-In	Incoming Policer L3 accepted packets (uint64)
26-50058-102	RtBrick-Policer-L3-Bytes-In	Incoming Policer L3 accepted bytes (uint64)
26-50058-103	RtBrick-Policer-L4-Packets-In	Incoming Policer L4 accepted packets (uint64)
26-50058-104	RtBrick-Policer-L4-Bytes-In	Incoming Policer L4 accepted bytes (uint64)

Those attributes will be encoded as subattributes (RFC2865) similar to broadband forum (BBF) line attributes to reduce the size of the RADIUS message. Counters with a zero value will be also excluded from the packet.

### Service Classification and Accounting

The underlying virtual output queueing (VOQ) is a common and efficient architecture for high performance switches but brings some major limitations. One obvious limitation is that queues must be allocated in ingress and can't be changed in egress as shown in the picture below.

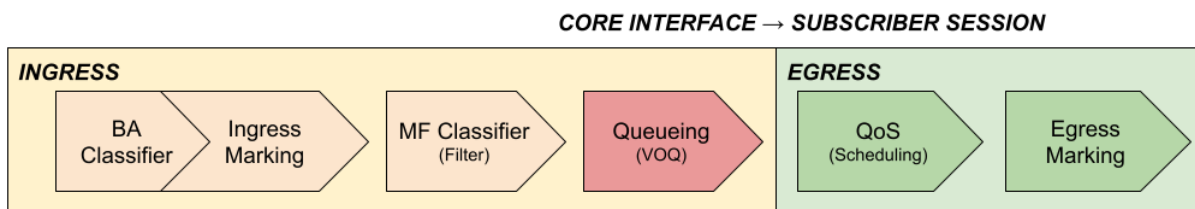

Service classification and accounting is based on standard behavior aggregate (BA) and multifielid classifier (MF) bound global or to ingress interfaces matching on some protocol fields assigning a traffic class. Downstream traffic (to subscriber) is counted per subscriber and class using queue counters to count only traffic not dropped by QoS. Upstream traffic (from subscribers) is countered per subscriber and policer level.

Some service providers would like to control if premium traffic is handled differently on a per subscriber basis which can be also achieved with VOQ as explained below.

Let us assume a product which handles video streaming services with higher priority or excludes those traffic from actual data volume. With VOQ the classification as Video is done on the ingress core interface equally for all subscribers regardless of the booked product. Now instead of changing the queue per subscriber in egress, the behavior of the queue can be changed to behave equally to BestEffort which is supported in egress per subscriber.

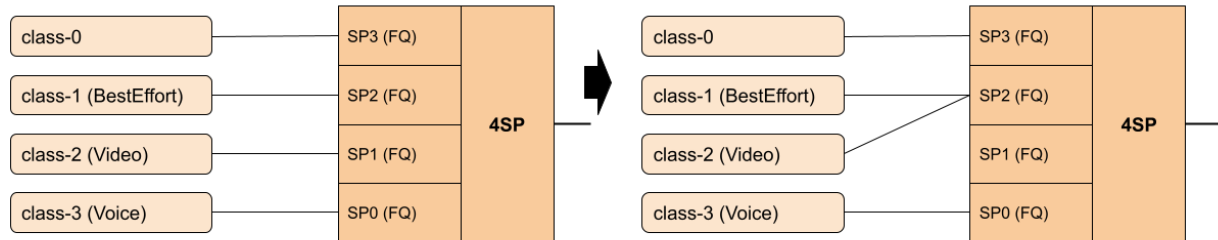

The corresponding Video traffic is now threaded equally to BestEffort but still counted separately. For accounting purposes the traffic of BestEffort and Video can be simply added in the billing infrastructure to get the actual amount of BestEffort traffic.

In upstream, the expected class and policer level can be assigned per subscriber because BA and MF classifiers are bound to the PPPoE session in ingress.

### 5.2.6. RADIUS Accounting Adjustment Configuration

The accounting adjustment allows to do some basic counter adjustment for RADIUS interims and stop accounting request messages using the following parameters from the AAA configuration profile (**global.access.aaa.profile.config**).

This counter adjustment allows normalizing counters with different encapsulations (double tagged, untagged, ...) to L3 counters for example.

Parameter	Type	Description
accounting_ingress_source	uint8	Source of session ingress counter (1: LIF or 3: POLICER)  <i>Default: LIF</i>
accounting_egress_source	uint8	Source of session egress counter (1: LIF or 2: CLASS)  <i>Default: LIF</i>

<b>Parameter</b>	<b>Type</b>	<b>Description</b>
ingress_byte_adjustment_value	float	Adjust ingress LIF counters by +/-N bytes per packet  <i>Default: 0.00</i>
ingress_byte_adjustment_factor	float	Adjust ingress LIF counters by factor  (executed after adjustment value)  <i>Default: 1.00</i>
egress_byte_adjustment_value	float	Adjust egress LIF counters by +/-N bytes per packet  <i>Default: 0.00</i>
egress_byte_adjustment_factor	float	Adjust egress LIF counters by factor  (executed after adjustment value)  <i>Default: 1.00</i>
accounting_egress_class_byte_adjustment_value	float	Adjust egress CLASS counters by +/-N bytes per packet  <i>Default: 0.00</i>
accounting_egress_class_byte_adjustment_factor	float	Adjust egress POLICER counters by factor  (executed after adjustment value)  <i>Default: 1.00</i>
accounting_ingress_policer_byte_adjustment_value	float	Adjust ingress POLICER counters by +/-N bytes per packet  <i>Default: 0.00</i>
accounting_ingress_policer_byte_adjustment_factor	float	Adjust ingress LIF counters by factor  (executed after adjustment value)  <i>Default: 1.00</i>

The byte adjustment value supports positive and negative values like -20.0 or 20.0. Provided decimal digits in the adjustment values are ignored.

The byte adjustment factors support positive values and only the first two decimal digits are used like 0.98 (-2%) or 1.02 (+2%).

## 5.2.7. RADIUS Redundancy

It is possible to configure multiple RADIUS authentication and accounting servers for redundancy and or load-balancing.

The following two algorithms are supported:

- **DIRECT (default):** Requests are sent to the server following the one where the last request was sent. If the subscriber daemon receives no response from the server, requests are sent to the next server and so on.
- **ROUND-ROBIN:** Requests are sent to the server following the one where the last request was sent. If the subscriber daemon router receives no response from the server, requests are sent to the next server and so on.

## 5.2.8. Test AAA

The test AAA subscriber feature allows operators to verify and test authentication and accounting (e.g. local or RADIUS) by emulating a subscriber without the need for external clients to be connected. This is a commonly used feature used during troubleshooting or to validate the RADIUS configuration.

Test subscribers will be created by adding a request object into the test aaa request table (**global.subscriber.1.test.aaa.request**) via API or CLI. This request object includes beside username and password also a spoofed interface, outer-vlan, inner-vlan and MAC address required to build corresponding attributes like NAS port identifiers or the vendor specific RtBrick-Access-Stack. It is also possible to add an Agent-Circuit-Id or Agent-Remote-Id to test line based authentication.

This new object will first trigger a validation plugin to reject invalid requests (e.g. subscriber-id out of range, missing mandatory attributes, ...). The add callback for this object will trigger the creation of the actual subscriber. Deleting the request object will trigger the termination of the subscriber. If this subscriber terminates for other reasons like CoA or CLI, the subscriber remains in a terminated state until the request object is deleted.



Compared to real subscribers, test subscribers will not trigger any forwarding state. Therefore no object will be created in the following tables for those subscribers:

- global.access.1.subscriber.ifl

But the following tables will be populated for operators to check dynamic QoS, filters or IGMP:

- global.access.1.subscriber.qos
- global.access.1.subscriber.qos.shaper
- global.access.1.subscriber.filter
- global.access.1.subscriber.igmp.service

Those entries are ignored internally as there is no matching subscriber interface (IFL) (global.access.1.subscriber.ifl). The only exception here is the filter table meaning that received filters (ADF) learned from RADIUS are installed in the ACL table and applied with the IP addresses of the test subscribers.

### **Test AAA Subscriber-Id:**

In RBFS each subscriber is uniquely identified by subscriber-id which is a 64 bit number allocated in a distributed fashion by the application creating the subscriber (for example, pppoe for pppoe sessions). This uniqueness is achieved with the following format.

The first 8 bits are used to identify the application:

- 0x00 subscriberd
- 0x01 pppoe
- 0x02 l2tpd

The next 8 bits are used to identify the application sharding instance allocated (for example, pppoe.1, pppoe.2, and so on).

The remaining 48 bits are used to uniquely identify the subscriber, which theoretically allows up to 281474976710656 subscribers per application instance.

An emulated test subscriber needs also a subscriber-id.

```
-----  
* 0 1 2 3 4 5 6 7 8 9 0 1 2 3 4 5 6 7 8 9 0 1 2 3 4 5 6 7 8 9 0 1  
  
* +-----+-----+-----+-----+-----+-----+-----+-----+-----+-----+  
* | app-id (0) | app-instance | reserved |  
* +-----+-----+-----+-----+-----+-----+-----+-----+-----+-----+  
  
* | subscriber  
* +-----+  
  
-----
```

Assuming subscriber daemon instance 1 (subscriberd.1), the valid range for test subscriber identifiers is between 281474976710656 and 281479271677951.

```
Min Subscriber-Id: 281474976710656  
0000 0000 0000 0001 0000 0000 0000 0000 0000 0000 0000 0000 0000 0000 0000 0000  
  
Max Subscriber-Id: 281479271677951  
0000 0000 0000 0001 0000 0000 0000 0000 1111 1111 1111 1111 1111 1111 1111 1111
```

The subscriber identifier will be allocated manually by operators from this range which has the advantage to easier identify the subscriber created by request.

**Test AAA RADIUS Flow:**

### Test AAA

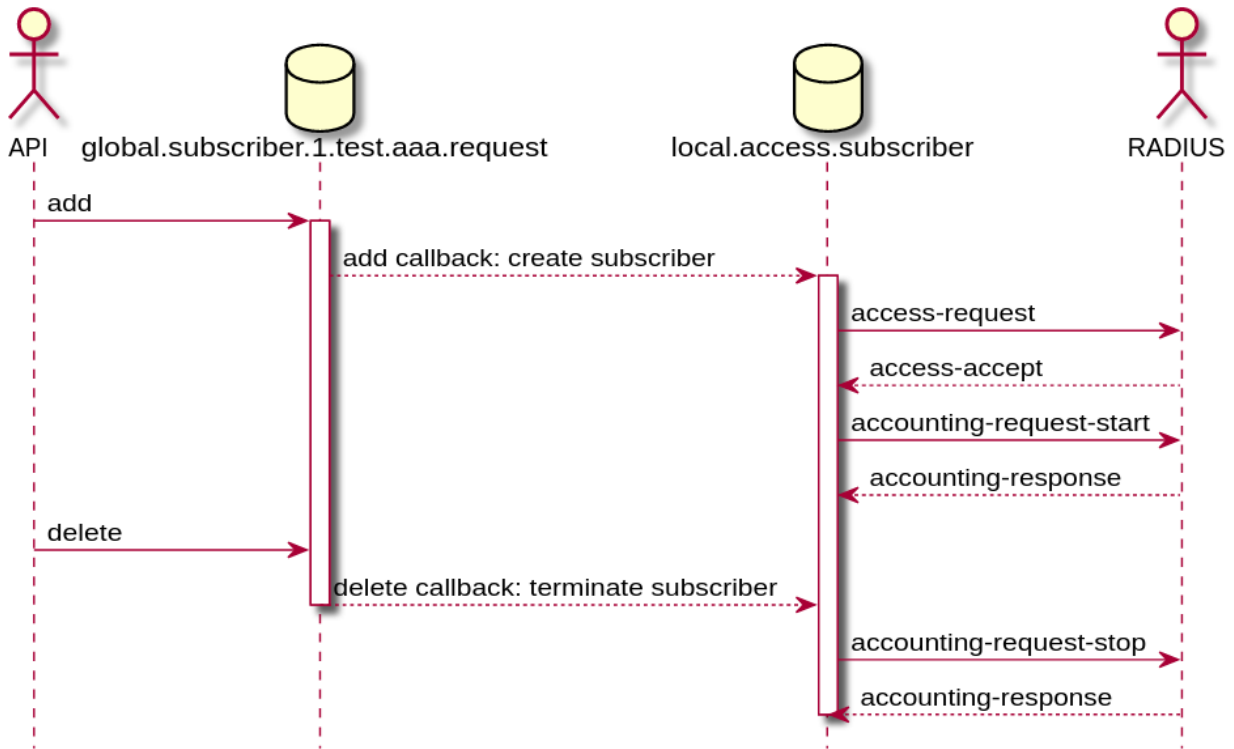

### Test AAA Attributes

Attribute	Mandatory	API	CLI	Default
Subscriber-Id	Yes	subscriber_id	subscriber-id	
Access Profile	Yes	access_profile_name	access-profile	
AAA Profile	Yes	aaa_profile_name	aaa-profile	
Username	No	user_name	username	test
Password	No	password	password	test
Agent-Circuit-id	No	aci	aci	
Agent-Remote-id	No	ari	ari	
Interface (IFP)	*	interface_name	interface	ifp-0/0/0
Outer VLAN	No	outer_vlan	outer-vlan	0
Inner VLAN	No	inner_vlan	inner-vlan	0

Attribute	Mandatory	API	CLI	Default
MAC Address	No	client_mac	**	00:00:00:00:00:00

\* The interface is mandatory via CLI but optional via API.

\*\* The client MAC address is currently supported via API only.

## Test AAA via CLI

**Note:** In CLI, strings must not contain the `"` character and therefore this is not permitted for username, aci or ari set via CLI. This limitation is valid for CLI only as subscribers created via API are allowed to use the `"` character in the mentioned strings.

### Add Test Subscriber:

```
supervisor@leaf1: op> test subscriber aaa request 281474976710656 pppoe-dual aaa-
default if1-0/0/1 username user1@rtbrick.com aci "0.0.0.0/0.0.0.0 eth 0/0" ari
DEU.RTBRICK.01
```

### List All Test Subscribers:

```
supervisor@leaf1: op> show subscriber filter type Test
Subscriber-Id      Interface      VLAN      State      Username
281474976710656   ifp-0/1/23    0:0      ESTABLISHED
user1@rtbrick.com
```

### Delete Test Subscriber:

```
supervisor@leaf1: op> test subscriber aaa delete 281474976710656
```

## Test AAA via API

### Add Test Subscriber:

```
{{rbfs_url}}/api/v1/rbfs/elements/{element}/services/subscriberd.1/proxy/bds/object/add
```

```
{
  "table": {
```

```

    "table_name": "global.access.1.test.aaa.request"
  },
  "objects": [
    {
      "attribute": {
        "subscriber_id": 281474976710658,
        "aaa_profile_name": "aaa-default",
        "access_profile_name": "pppoe-dual",
        "user_name": "user@rtbrick.com",
        "ari": "DEU.RTBRICK.01",
        "aci": "0.0.0.0/0.0.0.0 eth 0/0"
      }
    }
  ]
}

```

### Delete Test Subscriber:

```

{{rbfs_url}}/api/v1/rbfs/elements/{\{element}}/services/subscriberd.1/proxy/bds/object/delete

```

```

{
  "table": {
    "table_name": "global.access.1.test.aaa.request"
  },
  "objects": [
    {
      "attribute": {
        "subscriber_id": 281474976710658
      }
    }
  ]
}

```

### List All Test Subscribers:

```

{{rbfs_url}}/api/v1/rbfs/elements/{\{element}}/services/subscriberd.1/proxy/bds/table/walk

```

```

{
  "table": {
    "table_name": "global.access.1.test.aaa.request"
  }
}

```

## 5.2.9. Appendix A - RADIUS Dictionary

Following the RtBrick RADIUS dictionary in the well known FreeRADIUS format.

```

# This dictionary applies to RtBrick Full Stack (RBFS)
# https://www.rtbrick.com/
#
VENDOR          RtBrick 50058

BEGIN-VENDOR    RtBrick

ATTRIBUTE       RtBrick-Access-Hostname          21  string
ATTRIBUTE       RtBrick-Access-Port            22  string
ATTRIBUTE       RtBrick-Access-Stack           23  string
ATTRIBUTE       RtBrick-Access-MAC-Address     24  string

ATTRIBUTE       RtBrick-Subscriber-Id          25  integer64
ATTRIBUTE       RtBrick-Subscriber-Ifl         26  string

ATTRIBUTE       RtBrick-Terminate-Code         27  integer

ATTRIBUTE       RtBrick-L2TP-Pool              40  string
ATTRIBUTE       RtBrick-L2TP-Profile           41  string
ATTRIBUTE       RtBrick-L2TP-Tx-Connect-Speed  42  integer
ATTRIBUTE       RtBrick-L2TP-Rx-Connect-Speed  43  integer

ATTRIBUTE       RtBrick-QoS-Profile            62  string
ATTRIBUTE       RtBrick-QoS-Shaper             63  string
ATTRIBUTE       RtBrick-QoS-Parent-Scheduler   64  string
ATTRIBUTE       RtBrick-QoS-Policer            65  string
ATTRIBUTE       RtBrick-QoS-MFC                66  string
ATTRIBUTE       RtBrick-QoS-Queues             67  string

ATTRIBUTE       RtBrick-AAA-Profile            69  string
ATTRIBUTE       RtBrick-Service-Profile        70  string

ATTRIBUTE       RtBrick-IGMP-Status            71  integer
ATTRIBUTE       RtBrick-IGMP-Profile           72  string
ATTRIBUTE       RtBrick-IGMP-Version           73  integer
ATTRIBUTE       RtBrick-IGMP-Max-Members       74  integer

ATTRIBUTE       RtBrick-HTTP-Redirect-URL      75  string
ATTRIBUTE       RtBrick-IPv4-ACL-In            76  string
ATTRIBUTE       RtBrick-IPv4-ACL-Out           77  string
ATTRIBUTE       RtBrick-IPv6-ACL-In            78  string
ATTRIBUTE       RtBrick-IPv6-ACL-Out           79  string

ATTRIBUTE       RtBrick-Class-0-Packets-Out    81  integer64
ATTRIBUTE       RtBrick-Class-0-Bytes-Out      82  integer64
ATTRIBUTE       RtBrick-Class-1-Packets-Out    83  integer64
ATTRIBUTE       RtBrick-Class-1-Bytes-Out      84  integer64
ATTRIBUTE       RtBrick-Class-2-Packets-Out    85  integer64
ATTRIBUTE       RtBrick-Class-2-Bytes-Out      86  integer64
ATTRIBUTE       RtBrick-Class-3-Packets-Out    87  integer64
ATTRIBUTE       RtBrick-Class-3-Bytes-Out      88  integer64
ATTRIBUTE       RtBrick-Class-4-Packets-Out    89  integer64
ATTRIBUTE       RtBrick-Class-4-Bytes-Out      90  integer64
ATTRIBUTE       RtBrick-Class-5-Packets-Out    91  integer64
ATTRIBUTE       RtBrick-Class-5-Bytes-Out      92  integer64
ATTRIBUTE       RtBrick-Class-6-Packets-Out    93  integer64
ATTRIBUTE       RtBrick-Class-6-Bytes-Out      94  integer64
ATTRIBUTE       RtBrick-Class-7-Packets-Out    95  integer64
ATTRIBUTE       RtBrick-Class-7-Bytes-Out      96  integer64
    
```

```

ATTRIBUTE      RtBrick-Policer-L1-Packets-In      97  integer64
ATTRIBUTE      RtBrick-Policer-L1-Bytes-In       98  integer64
ATTRIBUTE      RtBrick-Policer-L2-Packets-In  99  integer64
ATTRIBUTE      RtBrick-Policer-L2-Bytes-In  100 integer64
ATTRIBUTE      RtBrick-Policer-L3-Packets-In  101 integer64
ATTRIBUTE      RtBrick-Policer-L3-Bytes-In  102 integer64
ATTRIBUTE      RtBrick-Policer-L4-Packets-In  103 integer64
ATTRIBUTE      RtBrick-Policer-L4-Bytes-In  104 integer64

ATTRIBUTE      RtBrick-DNS-Primary      131  ipaddr
ATTRIBUTE      RtBrick-DNS-Secondary    132  ipaddr
ATTRIBUTE      RtBrick-DNS-Primary-IPv6  134  ipv6addr
ATTRIBUTE      RtBrick-DNS-Secondary-IPv6 135  ipv6addr

ATTRIBUTE      RtBrick-Instance         137  string
ATTRIBUTE      RtBrick-Gateway-If1      138  string

ATTRIBUTE      RtBrick-Connection-Status-Message 139  string

ATTRIBUTE      RtBrick-LI-Action        140  integer encrypt=2
ATTRIBUTE      RtBrick-LI-Identifier    141  integer encrypt=2
ATTRIBUTE      RtBrick-LI-Direction     142  integer encrypt=2
ATTRIBUTE      RtBrick-LI-MED-Instance  143  string  encrypt=2
ATTRIBUTE      RtBrick-LI-MED-IP        144  ipaddr  encrypt=2
ATTRIBUTE      RtBrick-LI-MED-Port      145  integer encrypt=2

#          VALUE MAPS
#
#          Attribute          Name          Number
VALUE     RtBrick-LI-Action   NOOP        0
VALUE     RtBrick-LI-Action   ON           1
VALUE     RtBrick-LI-Action   OFF         2

VALUE     RtBrick-LI-Direction  INGRESS     1
VALUE     RtBrick-LI-Direction  EGRESS     2
VALUE     RtBrick-LI-Direction  BOTH       3

VALUE     RtBrick-IGMP-Status   DISABLED    0
VALUE     RtBrick-IGMP-Status   ENABLED     1

VALUE     RtBrick-IGMP-Version  V1          1
VALUE     RtBrick-IGMP-Version  V2          2
VALUE     RtBrick-IGMP-Version  V3          3

END-VENDOR RtBrick
    
```

## 5.2.10. Appendix B - RADIUS Standard Attributes Supported

**Disclaimer Note:** The following table presents the current development state of the RADIUS attributes supported in RBFS. Some of these may be incomplete and are subjected to change at any time without any notice.

RFC	Attribute		Access		Accounting				CoA	
	#	Name	Reque st	Respo nse	Acct- Start	Acct- Interi m	Acct- Stop	Acct- On	Reque st	Respo nse



2865

Technical Documentation: RBFS User Guides		Message							
25	Class		X	X	X	X			
32	NAS- Identifier	X		X	X	X	X		
61	NAS- Port- Type	X		X	X	X			

2688	40	Acct-Status-Type			X	X	X	X		
	41	Acct-Delay-Time								
	42	Acct-Input-Octets				X	X			
	43	Acct-Output-Octets				X	X			
	44	Acct-Session-ID	X		X	X	X			
	45	Acct-Authentic								
	46	Acct-Session-Time					X			
	47	Acct-Input-Packets				X	X			
	48	Acct-Output-Packets				X	X			
	49	Acct-Terminate-Cause					X			

2869	52	Acct-Input-Gigawords				X	X			
	53	Acct-Output-Gigawords				X	X			
	55	Event-Timestamp			X	X	X			
2865	60	CHAP-Challenge	X							

2868	64	Tunne l-Type		X	X	X	X			
	65	Tunne l- Mediu m- Type		X						
	66	Tunne l- Client- Endpo int		X	X	X	X			
	67	Tunne l- Server -Endp oint		X	X	X	X			
	69	Tunne l- Passw ord		X						
	81	Tunne l- Privat e- Group -ID		X	X	X	X			
	82	Tunne l- Assign ment- ID		X	X	X	X			
	83	Tunne l- Prefer ence		X					X	

2869	85	Acct-Interim-Interval	X						X	
	87	NAS-Port-Id	X		X	X	X			
	88	Frame-d-Pool		X						
2868	90	Tunnel-Client-Auth-ID		X	X	X	X			
	91	Tunnel-Server-Auth-ID		X	X	X	X			
3162	97	Frame-d-IPv6-Prefix		X	X	X	X			
	100	Frame-d-IPv6-Pool		X						
3576	101	Error-Cause								X
4818	123	Delegated-IPv6-Prefix		X	X	X	X			

6911	171	Delegated-IPv6-Prefix-Pool		X							
------	-----	----------------------------	--	---	--	--	--	--	--	--	--

4679





	m- Low- Power								
26-3561-139	Maxi- mum- Interle- aving- Delay- Upstr- eam	X	X	X	X	X			
26-3561-140	Actual -Interl- eaving -Delay -Upstr- eam	X	X	X	X	X			
26-3561-141	Maxi- mum- Interle- aving- Delay- Down- stream	X	X	X	X	X			
26-3561-142	Actual -Interl- eaving -Delay -Down- stream	X	X	X	X	X			
26-3561-144	Acces- s- Loop- Encap- sulati- on	X	X	X	X	X			

RtBric  
k



















50058-138	k- Gateway-138							
26-50058-139	RtBric k- Connection-Status-Message		X				X	
26-50058-140	RtBric k-LI-Action		X				X	
26-50058-141	RtBric k-LI-Identifier		X				X	
26-50058-142	RtBric k-LI-Direction		X				X	
26-50058-143	RtBric k-LI-MED-Instance		X				X	
26-50058-144	RtBric k-LI-MED-IP		X				X	
26-50058-145	RtBric k-LI-MED-Port		X				X	

### 5.2.11. Appendix C - Access Deployments

The following picture shows different deployments typically used in access networks.

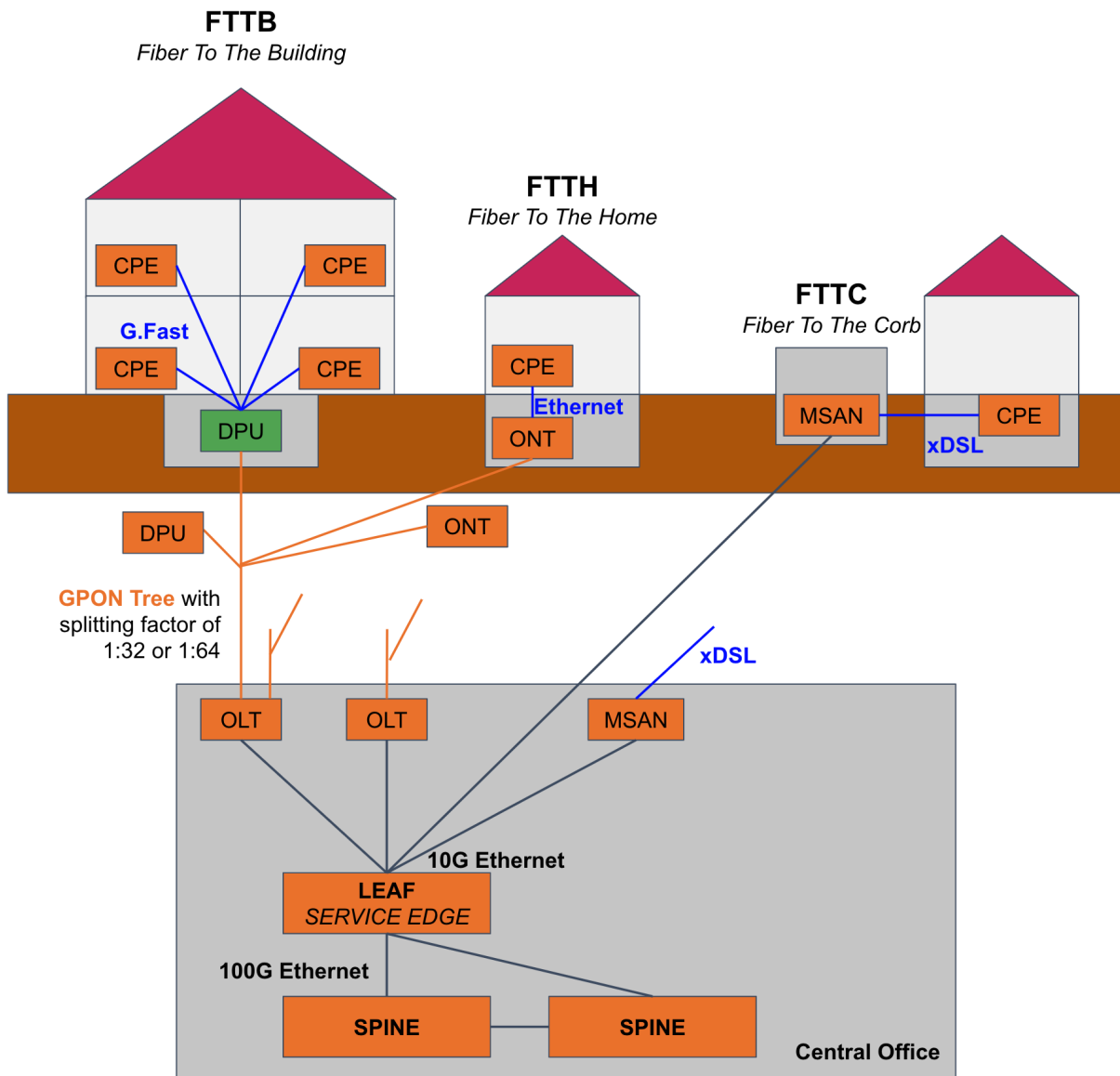

The LEAF and SPINE are bare metal switches running RBFS where the LEAF is responsible for service edge functionalities like PPPoE subscriber termination and the SPINE builds the actual fabric core. Multiple LEAF switches will be connected to a pair of spine switches.

## 5.3. RBFS Carrier-Grade Network Address Translation

### 5.3.1. RBFS Carrier-Grade Network Address Translation Overview

## Carrier-Grade NAT

The rise of technologies and the rapid growth of mobile devices and cloud services worldwide resulted in the exhaustion of IPv4 addresses. Broadband service providers face a growing challenge as this 32-bit address is insufficient to meet the ever-growing demand and the cost of obtaining public IP addresses for every individual subscriber. Though the launch of IPv6 can address the IPv4 depletion problem, migrating to an IPv6 network becomes vastly complex and costly. IPv6 also does not provide backward compatibility with IPv4. Consequently, migrating to IPv6 is not an ideal solution for many broadband service providers.

RBFS Carrier-Grade Network Address Translation (CGNAT) is a prominent technology solution that addresses the IPv4 exhaustion challenge of service providers. The solution helps to use private network addresses and to limit the use of publicly routable IPv4 addresses significantly.

RBFS CGNAT allows service providers to serve a large number of their subscribers using a limited number of public IPv4 addresses. It saves costs on public IPv4 addresses and conserves their IPv4 address pools.

### Static NAT

Static NAT associates one private IP address with one public IP address. This is a one-to-one mapping and you must manually define the mapping between a private and public address.

### Dynamic NAT

In Dynamic NAT, internal private IPv4 addresses are mapped with a public IPv4 address and this mapping of a private IPv4 address to a public IPv4 address happens dynamically. The router dynamically picks an address from the address pool that is not currently assigned.

### NAT444

RBFS CGNAT supports NAT444. NAT 444 refers to three sets of IPv4 addresses: Customer private, ISP private, and public Internet. Network address translation occurs from customer private to ISP private, and then ISP private to public. The NAT444, also known as CGNAT, functionality maps IPv4 subscriber private addresses to IPv4 public addresses.

The following diagram illustrates a high-level view of RBFS CGNAT.

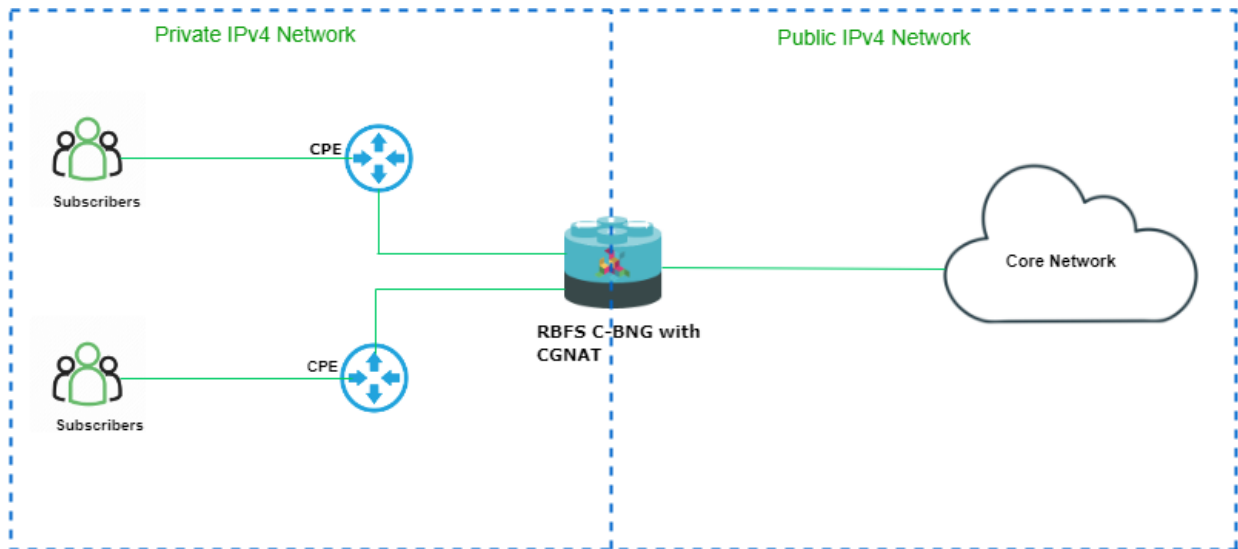

## RBFS CGNAT Benefits

RBFS CGNAT allows service providers to provide services to a large number of their subscribers using a limited number of public IPv4 addresses. The benefits include:

### Conserve Public IPv4 Addresses

The solution helps service providers conserve expensive public IPv4 addresses by enabling multiple subscribers to share a single public IPv4 address. With CGNAT, one public IPv4 address can manage hundreds of devices within the private network. It reduces the requirement of continually buying additional public IP addresses.

### Enhance Security

In addition to stretching the limited pool of public IPv4 addresses even further, CGNAT also provides significant security benefits. It helps to enhance network security by keeping the internal addressing private from the external network. It makes it difficult for attackers to target specific devices on the network by preventing attacks that target specific IP addresses.

### Performance at Carrier-Grade

RBFS CGNAT solution implements the functions of IPv4 address translation in the network of service providers. Service providers can deploy NAT in a way that allows multiple subscribers to share a single global IPv4 address and scale to several

thousands of address translations. CGNAT operations are implemented at the forwarding plane (hardware level) to ensure optimal performance. This hardware-level implementation achieves high throughput with no performance impact and packet processing occurs without overburdening the CPU. The solution offers carrier-grade scalability with fast translation rates and a large number of IPv4 address and port number translations.

## Understanding RBFS CGNAT Implementation

RBFS CGNAT solution has been designed to support Port Address Translation, also known as Network Address Port Translation (NAPT), which has the greatest potential to conserve IPv4 addresses for service providers. NAPT is known as an effective method to allow multiple devices to connect to the Internet using a single public IPv4 address.

### Network Address Port Translation

Network Address Port Translation is a dynamic NAT in which port numbers along with IP address are used to identify which traffic belongs to which private IP address. RBFS CGNAT translates the source private IPv4 address and port number to a public source IPv4 address and unique port number. This allows multiple devices with different private IP addresses to use a single public IPv4 address. The unique port number ensures that the traffic is delivered to the correct device.

The following diagrams illustrate how RBFS CGNAT works at a high level.

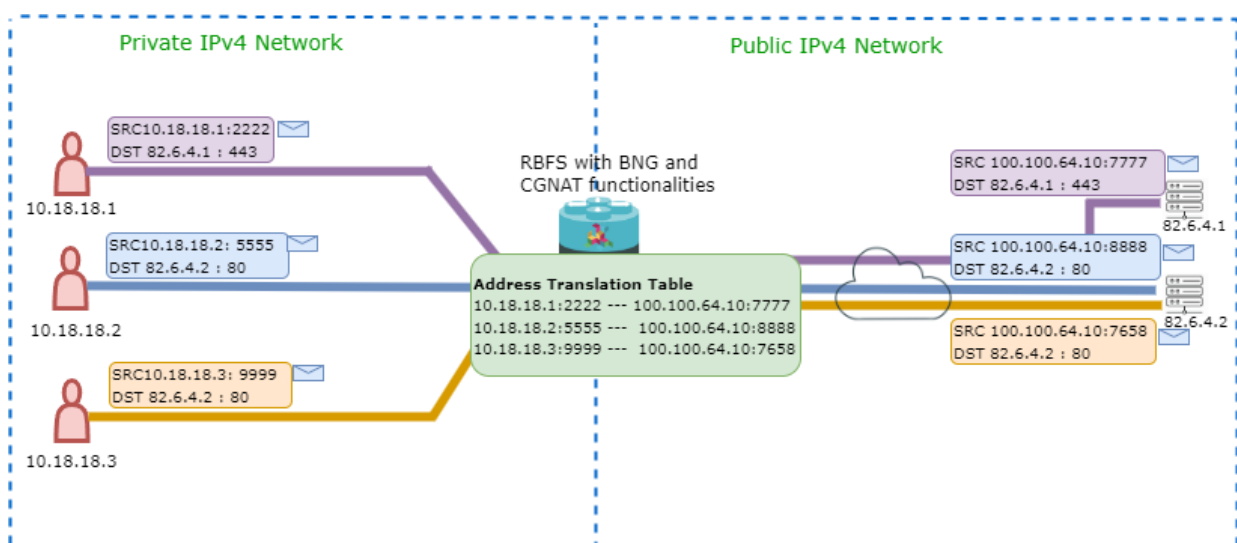

The diagram shows three subscribers using private IPv4 addresses (10.18.18.1, 10.18.18.2, and 10.18.18.3) send traffic to two different servers (82.6.4.1 and



82.6.4.2) on the public network.

BNG with CGNAT performs the address translation by replacing the source private IPv4 address with the public IPv4 address from the address pool and the source port number with a unique port number. After the address translation, the device forwards the traffic to the destination servers. After the translation, packets have a new source IPv4 address which is the public IPv4 and a unique port number as per the mapping in the address translation table.

CGNAT maintains a translation table with the entries. Entries are records of mapped private IPv4 addresses and port numbers with the public IPv4 addresses and port numbers.

The downstream traffic from the servers traverses to the RBFS CGNAT device. The packets coming from external hosts include the destination address as the (translated) public IPv4 address. CGNAT device performs reversal address translation for these packets as per the translation table mapping for the downstream traffic.

NAPT helps to significantly reduce the number of logs generated as it generates logs only during the allocation and release of each block of ports.

### **Deterministic NAT**

RBFS CGNAT offers support for deterministic NAT mode, which provides a consistent mapping of private IPv4 addresses with public IPv4 addresses and port ranges. This mode ensures a one-to-one mapping of private IPv4 addresses with public IPv4 addresses, allowing you to specify the private address and its matching public address and port range. The given private IPv4 address is always translated to the same public address.

In addition, deterministic NAT guarantees a predetermined and fixed translation for a given internal address with a public IPv4 and port combination, ensuring consistency and stability in the mapping. This feature is particularly useful for applications that involve security protocols, as well as for service providers who need to track subscriber sessions.

Furthermore, deterministic NAT significantly reduces address translation logs, as private IPv4 addresses are always mapped to public IPv4 addresses and port ranges.

## Address Translation Table

Port mapping is a feature that allows multiple devices to share the same public IPv4 address with different port numbers. CGNAT generates a unique port number for each subscriber session. Port mapping helps to determine the correct host among the many devices in the private network that use the same public IPv4 address.

RBFS CGNAT maintains an address translation table that maps private IPv4 addresses and port numbers to their corresponding public IPv4 addresses and ports. Whenever an incoming packet arrives, CGNAT checks the translation table to see if a translation entry exists for that packet. If there's an entry, the CGNAT replaces the source IPv4 address and port number in the packet header with the mapped public IPv4 address and port number.

When a device on the Internet sends packets downstream, the CGNAT software uses the translation table for address translation reversal. It replaces the destination public IPv4 address and port number in the packet header with the corresponding private IPv4 address and port number.

## NAT IP Pools and Chaining

A NAT pool contains a range of multiple public IP addresses. You can create multiple pools and associate them with a NAT service. Pool chaining is a method in which you can associate one pool with another. For a pool, you can define 'next pool name'; so that when the pool gets exhausted with the IPv4 addresses, the next pool that is defined will take over.

## Aging

Aging refers to the time that a translation entry exists or remains in the address translation table after it was last used.

The entries in the translation table have a finite lifespan as the software implements mechanisms to handle session timeouts.

When a host sends a packet to a destination, CGNAT translates the private IPv4 address and port to a public IPv4 address and port. This mapping is recorded as an entry in the address translation table. The software always looks up the translation table whenever it receives a packet to verify that any entry exists for the packet in the translation table. The software performs the address translation based on the

recorded entries and its associated mappings for both inbound and outbound packets.

If there is no activity related to a specific mapping (for example, when there are no incoming or outgoing packets), the mapping will eventually be removed from the address translation table, once idle or unused entries are detected, entries removed from the address translation table to free up resources for the new upcoming traffic flows.

For TCP, idle or unused flows are typically detected by the receipt of TCP FIN-ACK packets, which indicate that both sides of the connection have finished sending data. Once detected, these flows are removed after a configurable aging timer expires.

For UDP, as it is a connectionless protocol, idle or unused flows are detected by periodically polling the flow traffic. As the number of UDP traffic flows increases, the idle flow detection mechanism also increases, ensuring that idle flows are removed in a timely manner. The aging of UDP flows is proportional to the number of traffic flows.

## **Logging**

RBFS CGNAT provides traffic monitoring capabilities to track and log network activities. The solution offers a flexible logging mechanism that can store information such as port numbers, time, destination, and address translation details. You can enable logging for CGNAT operations.

## **NAT for ICMP Messages**

The NAT-enabled RBFS devices can perform network address translation for ICMP echo request and reply messages. Subscribers can use ping command (ICMP Echo Request, Echo Reply) to check internet connectivity to external internet addresses when NAT is enabled. This feature is enabled by default.

## **NAT for TCP Control Messages**

RBFS with NAT supports address translation for TCP control messages using ACLs. It includes the TCP control messages such as FIN, FIN-ACK, RST, RST-ACK, SYN, and SYN-ACK. This feature is enabled by default.

## Supported Platforms

Not all features are necessarily supported on each hardware platform. Refer to the *Platform Guide* for the features and the sub-features that are or are not supported by each platform.

### 5.3.2. Carrier-Grade NAT Configuration

#### Configuration Hierarchy

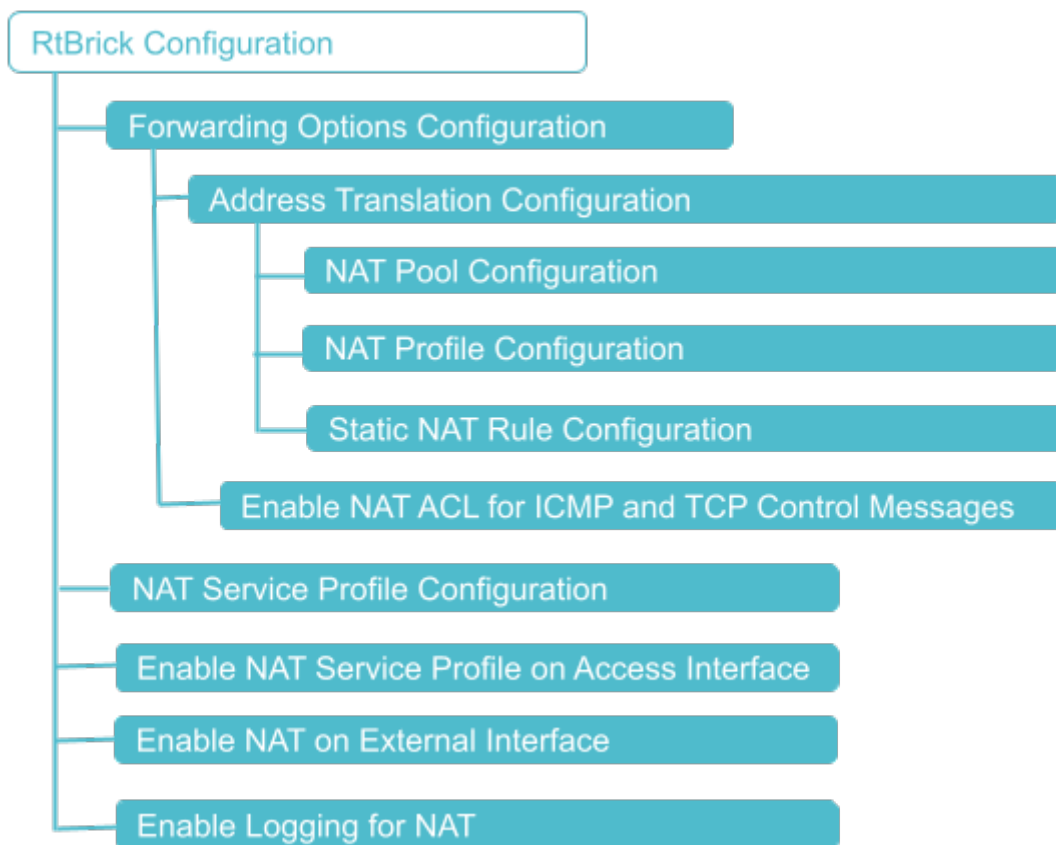

#### CGNAT Configuration

You must perform the following tasks to configure CG NAT.

1. Configure NAT Pool
2. Configure NAT Profile
3. Configure NAT Rule
4. NAT Service Profile Configuration

5. Enable NAT on an Instance
6. Enable NAT Service Profile on Access Interface
7. Enable NAT on External Interface
8. Enable Logging for NAT
9. Enabling NAT ACL Support for ICMP and TCP Control Messages

## Configuration Syntax and Commands

The following sections describe the CGNAT configuration syntax and commands.

### Configuring NAT Profile

A NAT profile defines how the NAT device has to perform the IPv4 address translation. NAT profile allows you to define an instance, IPv4 address pools, maximum number of translations, and mapping a particular internal IPv4 address with a particular external IPv4 address for a deterministic address translation.

You can create NAT profile for an RBFS instance using the 'instance' option. Also, you can define the TCP or UDP traffic type for the profile.

A single NAT profile can be attached to subscribers across different instances. This means that regardless of which instance a subscriber belongs to, they can share the same NAT profile. For example, subscribers in different routing instances can be managed using the same NAT settings.

Subscribers within the same instance can be assigned different NAT profiles. Different groups of subscribers or services within the same instance can have tailored NAT configurations.

### Syntax:

```
set forwarding-options address-translation profile <profile-name> <attribute>
<value>
```

Attribute	Description
<profile-name>	Specify the NAT profile name.

Attribute	Description
deterministic [true]	Specify deterministic as true to enable deterministic NAT for the profile. Deterministic NAT allows subscribers always to connect with a single public IP.
instance	Specify the RBFS instance.
ip-protocol	Specify the protocol: TCP or UDP.
ip-protocol ageing-timeout <ageing-timeout>	Specify the ageing time value for the protocol. Default, 120 seconds. Allowed range: 60 - 86400 seconds.
ip-protocol control-plane-ageing-timeout <ageing-timeout>	Specify the TCP control ageing timeout value. Default, 10 seconds. Allowed range: 5 - 120 seconds.
max-rules	Specify the maximum number of rules for address translations for a public IPv4 address and for an interface.
pool	Specify the name of the public IP address pool.

The following commands configure the NAT profile named `nat_profile1`. The nat profile `nat_profile1` is configured on the instanced `vrf1` with a pool attached `nataddr_pool1`. Maximum rules are configured as 100 rules and the aging period is configured as 600 seconds for TCP traffic and 300 seconds for UDP traffic.

```
set forwarding-options address-translation profile nat_profile1
set forwarding-options address-translation profile nat_profile1 instance vrf1
set forwarding-options address-translation profile nat_profile1 pool nataddr_pool1
set forwarding-options address-translation profile nat_profile1 max-rules 100
set forwarding-options address-translation profile nat_profile1 ip-protocol TCP
ageing-timeout 600
set forwarding-options address-translation profile nat_profile1 ip-protocol UDP
ageing-timeout 300
set forwarding-options address-translation profile nat_profile1 ip-protocol other
ageing-timeout 300
```

### Example Configuration:

```
supervisor@rtbrick>cbng1.rtbrick.net: cfg> show config forwarding-options address-
translation profile
{
  "rtbrick-config:profile": [
    {
      "profile": "nat_profile1",
      "instance": "vrf1",
      "pool": "nataddr_pool1",
      "max-rules": "100",
```

```

"ip-protocol": {
  "TCP": {
    "ageing-timeout": 600
  },
  "UDP": {
    "ageing-timeout": 300
  },
  "other": {
    "ageing-timeout": 300
  }
}
]
}
    
```

## NAT Pool Configuration

A NAT IP address pool includes a set of public IPv4 addresses that are used for network address translation. You can create multiple public IPv4 address pools and one pool includes a range of public IPv4 addresses. These pools allocate public IPv4 addresses to subscribers during address translation. While configuring a pool, you can define the group of public IPv4 addresses belonging to that pool by specifying the lowest and highest IP addresses.

The system allows you to create multiple pools and define the association among them. You can define the 'next-pool-name' that takes over when the current pool gets exhausted with the IPv4 addresses. When one pool gets exhausted, the next pool takes over and starts serving the IP addresses to subscribers when the address translation occurs.

### Syntax:

**set forwarding-options address-translation pool** <pool-name> <attribute> <value>

Attribute	Description
<pool-name>	Specify the name of the address pool.
ipv4-address	Specify both the highest and lowest IPv4 addresses in the range of IPv4 addresses for the pool.
ipv4-address high	Specify the highest IPv4 address in the address pool. You must specify the highest IP address in the range of IP addresses.

Attribute	Description
ipv4-address low	Specify the lowest IPv4 address in the address pool. You must specify the lowest IP address in the range of IP addresses.
next-pool-name	Specify the name of the next address pool that is to be used when the current address pool is allocated completely.

### Example Configuration:

The following commands configure `nataddr_pool1` as the NAT pool and `nataddr_pool2` as the next pool.

It indicates NAT pool `nataddr_pool1` contains a range of public IPv4 addresses from `100.100.100.1` to `100.100.100.5`.

When the pool `nataddr_pool1` has fully allocated its IPv4 addresses, the next pool named `nataddr_pool2` will start allocating IPv4 addresses from its pool. The pool `nataddr_pool2` includes a range of IPv4 address from `100.100.101.1` to `100.100.101.150`.

```
set forwarding-options address-translation pool nataddr_pool1
set forwarding-options address-translation pool nataddr_pool1 next-pool-name
nataddr_pool2
set forwarding-options address-translation pool nataddr_pool1 ipv4-address low
100.100.100.1
set forwarding-options address-translation pool nataddr_pool1 ipv4-address high
100.100.100.5
set forwarding-options address-translation pool nataddr_pool2 ipv4-address low
100.100.101.1
set forwarding-options address-translation pool nataddr_pool2 ipv4-address high
100.100.101.150
```

### Example Configuration:

```
supervisor@rtbrick: cfg> show config forwarding-options address-translation pool
{
  "rtbrick-config:pool": [
    {
      "pool-name": "nataddr_pool1",
      "next-pool-name": "nataddr_pool2",
      "ipv4-address": {
        "low": "100.100.100.1",
        "high": "100.100.100.5"
      }
    }
  ],
}
```



```

{
  "pool-name": "nataddr_pool2",
  "ipv4-address": {
    "low": "100.100.101.1",
    "high": "100.100.101.150"
  }
}
]
}

```

## NAT Rule Configuration

You can define NAT rules only for static NAT. A NAT rule defines a match condition and a corresponding action. After you specify NAT rules, each packet is matched with each NAT rule. If a packet matches the condition specified in a rule, then the action corresponding to that match occurs. Match rules govern how the translation of private IPv4 addresses to public IPv4 addresses is performed.

With NAT rules, you can define how address translation is applied to traffic, and how to handle various protocols and data traffic, such as TCP and UDP, to ensure proper address translation and the mappings of private addresses to public addresses.

Rules also define how to handle inbound and outbound traffic, different protocols, and data traffic such as TCP and UDP for ensuring the proper address translation of traffic.

### Syntax:

**set forwarding-options address-translation rule** <rule-name> <attribute> <value>

Attribute	Description
<rule-name>	Specify the name of the rule.
ordinal <ordinal-value>	Specify the ordinal value. An ordinal value is a numerical representation that indicates its relative position or order.
ordinal <ordinal-value> instance	Specify the RBFS instance name.
ordinal <ordinal-value> ip- protocol [tcp/udp]	Specify the IP protocol, TCP or UDP.

Attribute	Description
ordinal <ordinal-value> local [ipv4-address/port]	Specify the private IPv4 address or port number that needs to be translated.
ordinal <ordinal-value> public [ipv4-address/port]	Specify the public IPv4 address. This public IP will be mapped with the private IP in the translation table.

### Configuring NAT Service Profile

You must create a NAT service profile and attach the service profile with the access interface for enabling CGNAT on the interface.

**Syntax:**

**set access service-profile** <profile-name> <attribute> <value>

Attribute	Description
<profile-name>	Name of the service profile.
profile <profile>	Specify the profile name for the address translation.

### Enable NAT Service Profile on the Access Interface

It is required to attach the NAT service profile to the access interface for enabling address translation on the interface.

**Syntax:**

**set access interface [double-tagged | single-tagged | untagged]** <interface-name> <outer-vlan-min> <outer-vlan-max> <inner-vlan-min> <inner-vlan-max>  
**service-profile-name** <service-profile-name>

Attribute	Description
service-profile	Configure global service profile.
<outer-vlan-min>	Specify the minimum number of outer VLANs. Allowed range: 1 - 4094.
<outer-vlan-max>	Specify the maximum number of outer VLANs. Allowed range 1 - 4094.

Attribute	Description
<inner-vlan-min>	Specify the minimum number of inner VLANs. Allowed range: 1 - 4094.
<inner-vlan-max>	Specify the maximum number of inner VLANs. Allowed range 1 - 4094.
service-profile-name	Specify the name of the service profile.

The following commands attach service profile `nat_service` to the interface (double-tagged) `ifp-0/0/17`. The configuration shows the minimum number of outer VLANs as 1000, the maximum number of outer VLANs as 1007, the minimum number of inner VLANs as 84 and the maximum number of inner VLANs as 4084. The access type configured is IPoE and the service profile is NAT service. AAA profile name is `ipoe-aaa` and the gateway IFL is `lo-0/0/0/100`.

IPoE subscriber with outer VLAN between 1000 and 1007, and inner VLAN between 84 and 4084 will be matched with this NAT service profile and a corresponding action will be taken. Anything outside these vlans will not have any action from this NAT service profile.

```
set access interface double-tagged ifp-0/0/17 1000 1007 84 4084
set access interface double-tagged ifp-0/0/17 1000 1007 84 4084 access-type IPoE
set access interface double-tagged ifp-0/0/17 1000 1007 84 4084 access-profile-name ipoe
set access interface double-tagged ifp-0/0/17 1000 1007 84 4084 service-profile-name nat_service
set access interface double-tagged ifp-0/0/17 1000 1007 84 4084 aaa-profile-name ipoe-aaa
set access interface double-tagged ifp-0/0/17 1000 1007 84 4084 gateway-ifl lo-0/0/0/100
```

```
{
  "rtbrick-config:interface": {
    "double-tagged": [
      {
        "interface-name": "ifp-0/0/17",
        "outer-vlan-min": 1000,
        "outer-vlan-max": 1007,
        "inner-vlan-min": 84,
        "inner-vlan-max": 4084,
        "access-type": "IPoE",
        "access-profile-name": "ipoe",
        "service-profile-name": "nat_service",
        "aaa-profile-name": "ipoe-aaa",
        "gateway-ifl": "lo-0/0/0/100"
      }
    ]
  }
}
```

```
}
```

The following commands configure a double-tagged interface `ifp-0/0/6` and outer VLAN minimum value is 1000, maximum value as 1007, inner VLAN minimum value as 84 and maximum value as 4084. The access type configured is PPPoE, service profile is NAT service. AAA profile name is configured as `ipoe-aaa`.

It indicates PPPoE subscriber with outer VLAN between 1000 and 1007, and inner VLAN between 84 and 4084 will be matched with this NAT service profile and a corresponding action will be taken. Anything outside these vlans will not have any action from this NAT service profile.

```
set access interface double-tagged ifp-0/0/16 1000 1007 84 4084
set access interface double-tagged ifp-0/0/16 1000 1007 84 4084 access-type PPPoE
set access interface double-tagged ifp-0/0/16 1000 1007 84 4084 access-profile-
name pppoe
set access interface double-tagged ifp-0/0/16 1000 1007 84 4084 service-profile-
name nat_service
set access interface double-tagged ifp-0/0/16 1000 1007 84 4084 aaa-profile-name
ipoe-aaa
```

### Example:

```
{
  "rtbrick-config:interface": {
    "double-tagged": [
      {
        "interface-name": "ifp-0/0/16",
        "outer-vlan-min": 1000,
        "outer-vlan-max": 1007,
        "inner-vlan-min": 84,
        "inner-vlan-max": 4084,
        "access-type": "PPPoE",
        "access-profile-name": "pppoe",
        "service-profile-name": "nat_service",
        "aaa-profile-name": "ipoe-aaa"
      },
    ]
  }
}
```

### Enable NAT on an Instance

You can enable address translation for a specific routing instance such as VRF or virtual router rather than globally across the entire router.

### Syntax:

**set instance** <instance-name> **address-translation true**

Attribute	Description
<instance-name>	Name of the instance.

The following command is used to enable address translation for the instance named 'vrf1'.

```
set instance vrf1 address-translation true
```

```
supervisor@rtbrick.net: op> show config instance vrf1 address-translation
{
  "rtbrick-config:address-translation": "true"
}
```

**Enable NAT on External Interface**

It is required to enable the NAT on the external (core-facing) interface.

**Syntax:**

**set interface** <interface-name> **unit** <unit-id> **address-translation direction** <public>

Attribute	Description
<interface-name>	Name of the interface.
<unit-id>	Configure the number of sub-interfaces under the physical interface.
public	Specify 'public' for the external interface.

The following commands configure the external interface **ifp-0/1/64** for IPv4 address translation. 'Unit' logical identifier for this physical interface. Direction 'public' shows the configuration on external interface for address translation.

```
set interface ifp-0/1/64 unit 100
set interface ifp-0/1/64 unit 100 address-translation
set interface ifp-0/1/64 unit 100 address-translation direction public
```

```
supervisor@rtbrick.net: cfg> show config interface ifp-0/1/64 unit 100
{
```

```
"rtbrick-config:unit": [
  {
    "unit-id": 100,
    "address-translation": {
      "direction": "public"
    }
  }
]
```

## Enable Logging for NAT

You can optionally enable logging for CGNAT operations.



All RBFS logs and related information is available in the *RBFS Logging User Guide*. For the list of RBFS logs, see [Log Reference](#).

**set log bd** <name> <options>

Attribute	Description
level	Specify the log level.
module	Specify the log module.
plugin-alias	Specify the plugin-alias URL. Plugin-alias is an external logging host server to which you can export logs. For example, Graylog.

The following commands configure logging for NAT module `natd` with a log level 'debug'.

```
set log bd natd
set log bd natd module nat
set log bd natd module nat level debug
```

```
supervisor@rtbrick.net: cfg> show config log bd natd
{
  "rtbrick-config:bd": [
    {
      "bd-name": "natd",
      "module": [
        {
          "module-name": "nat",
          "level": "debug"
        }
      ]
    }
  ]
}
```

}

## Enabling NAT ACL Support for ICMP and TCP Control Messages

You can enable Access Control Lists support for ICMP and TCP Control messages.

### Enabling NAT Support for ICMP Using ACLs

The NAT ACLs for ICMP packets allows address translation for ICMP request and response packets through the use of Access Control Lists (ACLs). This enhances the handling of ICMP traffic by providing precise control over NAT behavior for ICMP packets.



Setting up the NAT ACLs for ICMP will be handled by the NAT application with the 25.1.1 release, eliminating the need for manual configuration.

**set forwarding-options acl l3v4 rule** rule-name> ordinal <ordinal-number>  
<attribute > <value>

Attribute	Description
<rule-name>	Specify the name of the rule.
ordinal <ordinal-value>	Specify the ordinal value. An ordinal value is a numerical representation that indicates its relative position or order.
match	Define the conditions under which the rule will be applied. These conditions determine which packets the rule should act on.
action	Defines what happens to packets that match the rule's criteria.
priority	Determines the priority of the rule when multiple rules with the same ordinal value are evaluated.
direction	The rule applies to ingress or egress traffic.

Example commands:

```
set forwarding-options acl l3v4 rule NAT_TRAP
set forwarding-options acl l3v4 rule NAT_TRAP ordinal 1001
set forwarding-options acl l3v4 rule NAT_TRAP ordinal 1001 match direction ingress
```

```

set forwarding-options acl 13v4 rule NAT_TRAP ordinal 1001 match ip-protocol icmp
set forwarding-options acl 13v4 rule NAT_TRAP ordinal 1001 match destination-ipv4-
prefix-list PREFIXES_NAT_PUBLIC
set forwarding-options acl 13v4 rule NAT_TRAP ordinal 1001 action trap nat
set forwarding-options acl 13v4 rule NAT_TRAP ordinal 1001 priority 1001

set forwarding-options acl 13v4 rule NAT_TRAP ordinal 1002
set forwarding-options acl 13v4 rule NAT_TRAP ordinal 1002 match direction ingress
set forwarding-options acl 13v4 rule NAT_TRAP ordinal 1002 match source-ipv4-
prefix 100.64.0.0/10
set forwarding-options acl 13v4 rule NAT_TRAP ordinal 1002 match ip-protocol icmp
set forwarding-options acl 13v4 rule NAT_TRAP ordinal 1002 action trap nat
set forwarding-options acl 13v4 rule NAT_TRAP ordinal 1002 priority 1002
    
```

### Example:

```

supervisor@rtbrick>rtbrick.net: cfg> show config forwarding-options acl 13v4
{
  "rtbrick-config:13v4": {
    "rule": [
      {
        "rule-name": "NAT_TRAP",
        "ordinal": [
          {
            "ordinal-value": 1001,
            "match": {
              "direction": "ingress",
              "ip-protocol": "icmp",
              "destination-ipv4-prefix-list": "PREFIXES_NAT_PUBLIC"
            },
            "action": {
              "trap": "nat"
            },
            "priority": 1001
          },
          {
            "ordinal-value": 1002,
            "match": {
              "direction": "ingress",
              "source-ipv4-prefix": "100.64.0.0/10",
              "ip-protocol": "icmp"
            },
            "action": {
              "trap": "nat"
            },
            "priority": 1002
          }
        ]
      }
    ]
  }
}
    
```

The preceding configuration defines Layer 3 IPv4 Access Control List (ACL) rules for managing ICMP traffic. The rule with the ordinal value 1001 is designed to redirect ICMP traffic for Network Address Translation (NAT) processing based on specific



criteria. The ACL rule is named NAT\_TRAP.

The matching criteria for this rule include the direction of traffic, which is set to ingress. This means the rule applies only to incoming traffic. The specified protocol is ICMP, indicating that the rule is applicable to ICMP packets.

The 'destination-ipv4-prefix-list' is designated as PREFIXES\_NAT\_PUBLIC, which is a predefined list containing a range of IPv4 addresses. The rule specifically pertains to ICMP packets whose destination IP is included in the PREFIXES\_NAT\_PUBLIC list. These rules ensure that ICMP packets requiring NAT handling are identified and appropriately redirected to the NAT process. When an ICMP packet that meets the conditions (ingress, ICMP, and a destination in PREFIXES\_NAT\_PUBLIC) is detected, it is redirected (or punted) to the NAT process for further handling.

### Enabling NAT Support for TCP Control Messages Using ACL

This configuration enables address translation on TCP control messages through ACLs. The feature supports control messages such as FIN, SYN, and RST. It applies functionality to TCP control messages such as **fin-ack** and **rst-ack**.



Setting up the NAT ACLs for TCP control messages will be handled by the NAT application with the 25.1.1 release, eliminating the need for manual configuration.

#### Syntax:

```
set forwarding-options acl l3v4 rule <rune-name> ordinal <ordinal-number>
match tcp-control [fin-ack | rst-ack]
```

Attribute	Description
<rule-name>	Specify the name of the rule.
ordinal <ordinal-value>	Specify the ordinal value. An ordinal value is a numerical representation that indicates its relative position or order.
match	Define the conditions under which the rule will be applied. These conditions determine which packets the rule should act on.
action	Defines what happens to packets that match the rule's criteria.

Attribute	Description
priority	Determines the priority of the rule when multiple rules with the same ordinal value are evaluated.
direction	The rule applies to ingress or egress traffic.
tcp-control <fin-ack>	Matches TCP packets with the FIN-ACK control flag set.
destination-ipv4-prefix-list	Name of the prefix list. The list includes predefined destination IP addresses.

Example commands:

```

set forwarding-options acl 13v4 rule NAT_TRAP ordinal 1003
set forwarding-options acl 13v4 rule NAT_TRAP ordinal 1003 match direction ingress
set forwarding-options acl 13v4 rule NAT_TRAP ordinal 1003 match tcp-control fin-ack
set forwarding-options acl 13v4 rule NAT_TRAP ordinal 1003 match destination-ipv4-prefix-list PREFIXES_NAT_PUBLIC
set forwarding-options acl 13v4 rule NAT_TRAP ordinal 1003 action trap nat
set forwarding-options acl 13v4 rule NAT_TRAP ordinal 1003 priority 1003
set forwarding-options acl 13v4 rule NAT_TRAP ordinal 1004
set forwarding-options acl 13v4 rule NAT_TRAP ordinal 1004 match direction ingress
set forwarding-options acl 13v4 rule NAT_TRAP ordinal 1004 match source-ipv4-prefix 100.64.0.0/10
set forwarding-options acl 13v4 rule NAT_TRAP ordinal 1004 match tcp-control fin-ack
set forwarding-options acl 13v4 rule NAT_TRAP ordinal 1004 action trap nat
set forwarding-options acl 13v4 rule NAT_TRAP ordinal 1004 priority 1004
set forwarding-options acl 13v4 rule NAT_TRAP ordinal 1005
set forwarding-options acl 13v4 rule NAT_TRAP ordinal 1005 match direction ingress
set forwarding-options acl 13v4 rule NAT_TRAP ordinal 1005 match tcp-control rst-ack
set forwarding-options acl 13v4 rule NAT_TRAP ordinal 1005 match destination-ipv4-prefix-list PREFIXES_NAT_PUBLIC
set forwarding-options acl 13v4 rule NAT_TRAP ordinal 1005 action trap nat
set forwarding-options acl 13v4 rule NAT_TRAP ordinal 1005 priority 1005
set forwarding-options acl 13v4 rule NAT_TRAP ordinal 1006
set forwarding-options acl 13v4 rule NAT_TRAP ordinal 1006 match direction ingress
set forwarding-options acl 13v4 rule NAT_TRAP ordinal 1006 match source-ipv4-prefix 100.64.0.0/10
set forwarding-options acl 13v4 rule NAT_TRAP ordinal 1006 match tcp-control rst-ack
set forwarding-options acl 13v4 rule NAT_TRAP ordinal 1006 action trap nat
set forwarding-options acl 13v4 rule NAT_TRAP ordinal 1006 priority 1006

```

Example:

```

supervisor@rtbrick>rtbrick.net: cfg> show config forwarding-options acl 13v4
{
  "rtbrick-config:13v4": {
    "rule": [
      {

```

```

"rule-name": "NAT_TRAP",
"ordinal": [
  {
    "ordinal-value": 1003,
    "match": {
      "direction": "ingress",
      "tcp-control": "fin-ack",
      "destination-ipv4-prefix-list": "PREFIXES_NAT_PUBLIC"
    },
    "action": {
      "trap": "nat"
    },
    "priority": 1003
  },
  {
    "ordinal-value": 1004,
    "match": {
      "direction": "ingress",
      "source-ipv4-prefix": "100.64.0.0/10",
      "tcp-control": "fin-ack"
    },
    "action": {
      "trap": "nat"
    },
    "priority": 1004
  },
  {
    "ordinal-value": 1005,
    "match": {
      "direction": "ingress",
      "tcp-control": "rst-ack",
      "destination-ipv4-prefix-list": "PREFIXES_NAT_PUBLIC"
    },
    "action": {
      "trap": "nat"
    },
    "priority": 1005
  },
  {
    "ordinal-value": 1006,
    "match": {
      "direction": "ingress",
      "source-ipv4-prefix": "100.64.0.0/10",
      "tcp-control": "rst-ack"
    },
    "action": {
      "trap": "nat"
    },
    "priority": 1006
  }
]
}
}
}
}
}

```

The preceding configuration defines ACL for Layer 3 IPv4 traffic. The ACL is named NAT\_TRAP and consists of multiple rules that match specific traffic patterns and

apply a 'trap' action to punt the traffic for further NAT processing. Each rule is identified by an ordinal value.

Match Criteria includes direction which is specified as ingress. All rules are applied to ingress traffic. Protocol is defined as TCP traffic with specific control flags: **fin-ack** or **rst-ack**.

In the configuration:

- Ordinal 1003 matches TCP traffic with the **fin-ack** flag and a destination IP in the PREFIXES\_NAT\_PUBLIC list.
- Ordinal 1004 matches TCP traffic with the **fin-ack** flag and a source IP in the 100.64.0.0/10 range.
- Ordinal 1005 matches TCP traffic with the **rst-ack** flag and a destination IP in the PREFIXES\_NAT\_PUBLIC list.
- Ordinal 1006 matches TCP traffic with the **rst-ack** flag and a source IP in the 100.64.0.0/10 range.

### 5.3.3. Carrier Grade NAT Operational Commands

#### Carrier Grade NAT Show Commands

The RBFS CGNAT operational commands provide detailed information about the address translation operations.

#### NAT Pool Information

This command displays information about IPv4 address pool for a user.

#### Syntax:

**show address-translation allocation** <options>

Option	Description
pool	Specify the pool name.
user	Specify the user name.

Example for NAT pool allocation.

```

supervisor@rtbrick.net: cfg> show address-translation allocation pool
Pool: pool1
  Profile: nat_profile1
  Instance: ip2vrf
  Allocated: 100.00%
Pool: pool2
  Profile: nat_profile1
  Instance: ip2vrf
  Allocated: 100.00%
    
```

## Example for allocation details for subscribers

```

supervisor@rtbrick.net: cfg> show address-translation allocation user
User                               Original Address    Translated Address  Port
Range
ppp-0/1/20/72339069014638594      10.100.128.1       100.100.100.100    14912 -
14975
ppp-0/1/20/72339069014638594      10.100.128.1       100.100.100.100    18944 -
19007
ppp-0/1/20/72339069014638595      10.100.128.3       100.100.100.101    14976 -
15039
ppp-0/1/20/72339069014638595      10.100.128.3       100.100.100.101    18880 -
18943
ppp-0/1/20/72339069014638596      10.100.128.5       100.100.100.101    15104 -
15167
ppp-0/1/20/72339069014638596      10.100.128.5       100.100.100.101    17856 -
17919
ppp-0/1/20/72339069014638597      10.100.128.7       100.100.100.100    15104 -
15167
ppp-0/1/20/72339069014638597      10.100.128.7       100.100.100.100    17792 -
17855
ppp-0/1/20/72339069014638598      10.100.128.9       100.100.100.101    15040 -
15103
ppp-0/1/20/72339069014638598      10.100.128.9       100.100.100.101    17792 -
17855
ppp-0/1/20/72339069014638599      10.100.128.11      100.100.100.100    15040 -
15103
    
```

## NAT Rule Details

### Syntax:

**show address-translation rule** <options>

Option	Description
-	Without any option, the command displays the information for all rules.
instance	Displays NAT rule information for the specified instance.

Option	Description
summary	Displays summary of the information for the NAT rule.
user	Displays user information for the NAT rule.

Example for address translation rule for an instance.

```

supervisor@rtbrick.net: cfg> show address-translation rule instance default
Instance: default
User                               Protocol  Original Address          Translated
Address      Direction
ipoe-0/0/18/216454257090494481    tcp      11.100.128.24, 60011     100.100.100.1,
1048      Both
ppp-0/0/17/72339069014638604      tcp      11.100.128.25, 60011     100.100.100.2,
1034      Both
ipoe-0/0/18/216454257090494481    tcp      11.100.128.24, 60012     100.100.100.1,
1049      Both
ppp-0/0/17/72339069014638604      tcp      11.100.128.25, 60012     100.100.100.2,
1035      Both
ipoe-0/0/18/216454257090494481    tcp      11.100.128.24, 60013     100.100.100.1,
1050      Both
ppp-0/0/17/72339069014638604      tcp      11.100.128.25, 60013     100.100.100.2,
1036      Both
ipoe-0/0/18/216454257090494481    tcp      11.100.128.24, 60014     100.100.100.1,
1051      Both
ppp-0/0/17/72339069014638604      tcp      11.100.128.25, 60014     100.100.100.2,
1037      Both
ipoe-0/0/18/216454257090494481    tcp      11.100.128.24, 60015     100.100.100.1,
1052      Both
ppp-0/0/17/72339069014638604      tcp      11.100.128.25, 60015     100.100.100.2,
1038      Both
ipoe-0/0/18/216454257090494481    tcp      11.100.128.24, 60016     100.100.100.1,
1053      Both
ppp-0/0/17/72339069014638604      tcp      11.100.128.25, 60016     100.100.100.2,
1039      Both
ipoe-0/0/18/216454257090494481    tcp      11.100.128.24, 60017     100.100.100.1,
1054      Both
ppp-0/0/17/72339069014638604      tcp      11.100.128.25, 60017     100.100.100.2,
1040      Both
ipoe-0/0/18/216454257090494481    tcp      11.100.128.24, 60018     100.100.100.1,
1024      Both
ppp-0/0/17/72339069014638604      tcp      11.100.128.25, 60018     100.100.100.2,
1041      Both
ipoe-0/0/18/216454257090494481    tcp      11.100.128.24, 60019     100.100.100.1,
1025      Both
ppp-0/0/17/72339069014638604      tcp      11.100.128.25, 60019     100.100.100.2,
1042      Both
ipoe-0/0/18/216454257090494481    tcp      11.100.128.24, 60020     100.100.100.1,
1026      Both

```

Example for address translation rule summary. The example summary shows the total number of NAT rules for TCP flows.

```

supervisor@rtbrick.net: cfg> show address-translation rule summary

```

```
Instance: default
Source      Protocol    Rules
Dynamic    tcp         62
Total Dynamic Rules      62
```

Example for address translation rules for subscribers.

```
supervisor@rtbrick: cfg> show address-translation rule
Instance: ip2vrf
User          Protocol    Original Address    Translated
Address      Direction
ipoe-0/1/21/216454257090494746 tcp         11.100.129.0, 65001
100.100.100.101, 36874 Both
ipoe-0/1/21/216454257090494975 tcp         11.100.130.0, 65001
100.100.100.101, 60170 Both
ipoe-0/1/21/216454257090495232 tcp         11.100.131.0, 65001
100.100.101.101, 38730 Both
ppp-0/1/20/72339069014638594 tcp         10.100.128.1, 65001
100.100.100.100, 14914 Both
ipoe-0/1/21/216454257090494501 tcp         11.100.128.1, 65001
100.100.100.100, 2122 Both
ppp-0/1/20/72339069014638722 tcp         10.100.129.1, 65001
100.100.100.100, 19924 Both
ipoe-0/1/21/216454257090494747 tcp         11.100.129.1, 65001
100.100.100.100, 36746 Both
```

The example summary shows the total number of NAT rules for other protocol flows:

```
supervisor@rtbrick.net: cfg> show address-translation rule
Instance: ip2vrf
User          Protocol    Original Address    Translated
Address      Direction
ipoe-0/1/30/216454257090494465 icmp        10.100.128.1, 7684
100.100.100.100, 1024 Both
```

## NAT Trap Statistics

### Syntax:

#### show address-translation trap statistics

This command displays the information of packets trapped in the NAT daemon.

Example for TCP flow stats

```
supervisor@rtbrick: cfg> show address-translation trap statistics
Protocol  Flags          Status          Count
tcp       -|syn|-|-|-|-|-|-| Success        152958
tcp       -|syn|-|-|-|-|-|-| Failure         23186
```

Total Successful Traps:	152958
Total Failed Traps:	23186

Example for other flow (ICMP) stats:

```

supervisor@rtbrick>ufi09.q2c.u19.r4.nbg.rtbrick.net: cfg> show address-translation
trap statistics
Protocol  Flags                Status                Count
other    -|-|-|-|-|-|-|-    Success              50
Total Successful Traps:                50
Total Failed Traps:                    0
    
```

## NAT Error Details

This command displays NAT error information.

### Syntax:

#### **show address-translation error**

Example for address translation platform resource information.

```

supervisor@rtbrick.net: cfg> show address-translation error
INSTANCE - Packet Table
Counter      : 4
Current Update : Thu May 02 10:05:52 GMT +0000 2024
Last Update   : Thu May 02 10:05:52 GMT +0000 2024
POOL_CFG - Pool Flush
Counter      : 1
Current Update : Thu May 02 10:05:43 GMT +0000 2024
Last Update   : Thu May 02 10:05:43 GMT +0000 2024
    
```

## 5.4. RBFS HTTP Redirect Service

### 5.4.1. RBFS HTTP Redirect Service Overview

This document provides information about RBFS HTTP Redirect Service. For enabling HTTP Redirect service, it is required to create, associate, and apply subscriber filters (ACLs) for the subscribers. For information about subscriber filters and how to configure these filters, refer to the [RBFS Subscriber Filters User Guide](#).

RBFS HTTP Redirect service allows network service providers to intercept and redirect HTTP request traffic from subscribers to a designated captive portal



instead of the original destination. This service is useful in a multitude of use cases, ranging from subscriber re-authentication to enforcing acceptance of network usage policies.

This captive portal is a webpage where the redirected subscribers are landed up to fulfill certain actions or conditions before they are granted broader access to the network resources. There are various reasons why captive portals can be set up, such as the following:

- Accept the terms of service.
- Receive and manage HTTP requests to unauthorized web resources.
- Present a web page that requires the completion of certain actions from the subscriber.
- Serve commercial communication or network usage policy messages.

By implementing the RBFS HTTP Redirect Service, network service providers can efficiently manage user access and enforce compliance with network regulations and policies, ultimately enhancing the overall security and user experience within their network environment.

Based on the applied filters, RBFS performs three actions which are **accept**, **drop**, and **redirect**. The action **Accept** allows the subscribers to access the network resource that they request. The **Drop** action restricts the subscriber from accessing the network resource. Finally, the **Redirect** action, if enabled HTTP redirect service, takes the subscriber to a different portal where the service provider wants to fulfill certain actions by the subscriber before accessing the network resource.

In addition to RBFS Subscriber Filters, a redirect action is supported by RBFS through the utilization of Ascend Data Filters (ADF), as described in the [RBFS RADIUS Services Guide](#).

The RBFS HTTP Redirect Service together with the Subscriber Filters empowers network service providers to intercept and redirect HTTP request traffic from subscribers, guiding it towards a designated captive portal instead of its original destination.

## How RBFS HTTP Redirect Service Works

HTTP requests from subscribers to any destination are intercepted by the RBFS

HTTP Redirect service, if the subscriber filter rules are applied to the subscriber. In response to the request from the subscriber to access the network, the HTTP Redirect service provides the HTTP status code 302 along with the new URL to guide the subscriber to the new destination. To make it possible, the RBFS Subscriber Filters are employed, enabling the service to decide which requests should be redirected and which requests should be passed directly without redirection. In addition to RBFS Subscriber Filters, a redirect action is supported by RBFS through the utilization of Ascend Data Filters (ADF), as described in the [RBFS RADIUS Services Guide](#).

## Enabling HTTP Redirect Service Using RADIUS ADF

Both the RBFS Subscriber Filters and the HTTP Redirect Service can be dynamically enabled, disabled, and updated through RADIUS [access-accept](#) and [CoA](#) requests without requiring the re-establishment of the subscriber session. This flexibility allows network administrators to efficiently manage and modify these services as needed without disrupting subscriber connectivity.

RBFS provides a set of vendor-specific attributes to control the RBFS Subscriber Filters and the HTTP Redirect Service. The attributes include:

- VSA 26-50058-75 - RtBrick-HTTP-Redirect-URL
- VSA 26-50058-76 - RtBrick-IPv4-ACL-IN
- VSA 26-50058-77 - RtBrick-IPv4-ACL-OUT
- VSA 26-50058-78 - RtBrick-IPv6-ACL-IN
- VSA 26-50058-79 - RtBrick-IPv6-ACL-OUT

For more information about these attributes, see [RBFS RADIUS Services Guide](#).

## Limitations

The HTTP Redirect Service is currently supported only for IPoE subscribers. HTTP Redirect service can redirect only HTTP traffic. Typically, the majority of web requests are in HTTPS format, which cannot be redirected. Due to this limitation, most end-user devices, including PCs, smartphones, and tablets, automatically attempt to access specific well-known URLs to search for captive portals immediately after establishing a network connection. Two common examples are <http://connectivitycheck.gstatic.com> (vendor-independent) and <http://captive.apple.com> (Apple devices).

## 5.4.2. HTTP Redirect Service Configuration

The configuration hierarchy for the HTTP Redirect service is illustrated in the diagram.

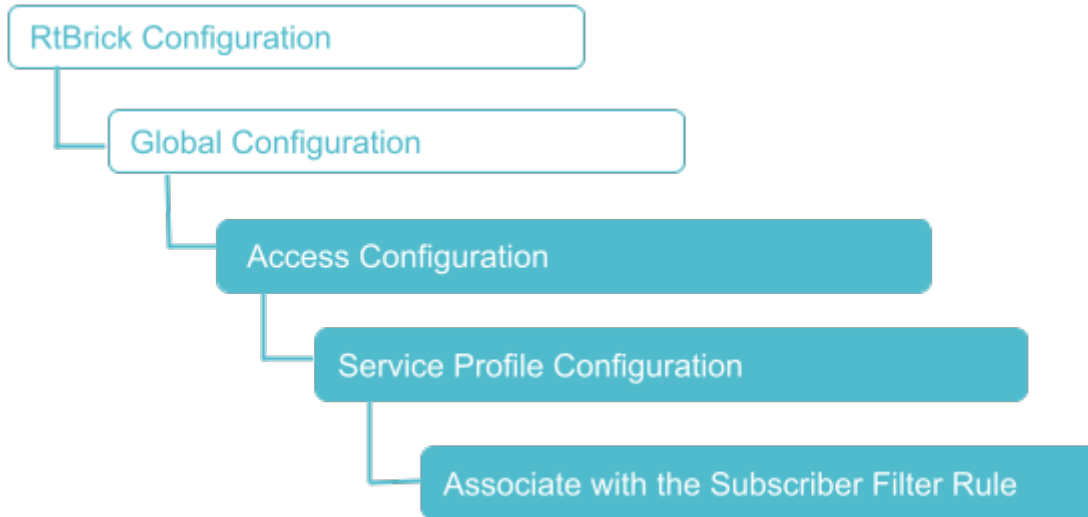

### Service Profile Configuration

Syntax:

**set access service-profile profile-name** <profile-name> <attribute> <value>

Attribute	Description
<profile-name>	Service profile name.
<http-redirect>	HTTP redirect service configuration.
<url>	HTTP redirect target URL.
<acl>	Subscriber ACL (filter) configuration.
<ipv4-acl-in>	IPv4 upstream ACL (ingress from subscriber).
<ipv4-acl-out>	IPv4 downstream ACL (egress to subscriber).
<ipv6-acl-in>	IPv6 upstream ACL (ingress from subscriber).
<ipv6-acl-out>	IPv6 downstream ACL (egress to subscriber).

The following example shows a service profile named HTTP, redirect URL as the redirect destination. The 'ipv4-acl-in' ACL is applied as the filter criteria or ACL rule for this redirection.

```
supervisor@router: cfg> show config access service-profile HTTP
{
  "rtbrick-config:service-profile": [
    {
      "profile-name": "HTTP",
      "http-redirect": {
        "url": "https://www.rtbrick.com"
      },
      "acl": {
        "ipv4-acl-in": "redirect-acl-in"
      }
    }
  ]
}
```

## 5.5. RBFS Subscriber Filters

### 5.5.1. RBFS Subscriber Filters Overview

RBFS Subscriber Filters, also referred to as subscriber ACLs, consist of a set of rules defining packet match criteria and actions. There are separate rules for IPv4 and IPv6 downstream (egress to subscriber) and upstream (ingress from subscriber) packets. These rules support various match criteria and actions, some of which are specific to address families or directions. Each rule is assigned a priority, and the decision between multiple matching rules is based on these priorities, where lower values take precedence.

The available actions include **accept**, **drop**, or **http-redirect** where the last one refers to the RBFS HTTP Redirect Service. When the action is **drop**, matching traffic is silently discarded. The filters are categorized into two primary types, namely **I3v4** for IPv4 and **I3v6** for IPv6, applicable to either ingress or egress direction.

To apply these filters to subscribers, there are two ways. They can be applied through the access **service-profile** or directly using the corresponding RADIUS attributes with the second method taking priority.

#### About the Match Criteria

When multiple match criteria are defined within a single rule, they are treated as a logical **AND** operation, requiring all criteria to be met for the rule to be considered as a match. However, using unsupported match criteria, such as **destination-ipv4-subscriber-prefix** in ingress (upstream), can potentially lead to session termination. In the case of **CoA** (Change of Authorization), the filter assignment is rejected using

CoA NAK, if such unsupported criteria are encountered.

Even if filters are assigned to a subscriber, those filters are applied globally, indicating that all traffic from all interfaces and subscribers is evaluated against all rules. Consequently, RBFS has introduced specific options to restrict rules to individual subscribers. For ingress (upstream) rules, it is recommended to enable the `subscriber-ifl` option, ensuring that only traffic received from the corresponding subscriber is matched. With the `subscriber-ifl` option, packets are matched based on incoming subscriber IFL. However, this option is not supported in egress(downstream), requiring the limitation of traffic using subscriber address prefix information. Thus, RBFS introduced the options `source-ipv4-subscriber-prefix`, `source-ipv6-subscriber-prefix`, `destination-ipv4-subscriber-prefix`, `destination-ipv6-subscriber-prefix`, `source-ipv6-delegated-subscriber-prefix`, and `destination-ipv6-delegated-subscriber-prefix`. With these options enabled, the dynamically assigned subscriber address prefix is automatically integrated into the corresponding filter instance to constrain those rules to a specific subscriber.



Improperly configured filters assigned to one subscriber may create a negative impact on other subscribers as well.

## 5.5.2. Subscriber Filters Configuration

The configuration hierarchy for Subscriber ACL is illustrated in the diagram.



### Configure Subscriber Filters

Syntax:

**set forwarding-options subscriber-acl** <I3v4|I3v6> **rule** <rule-name> **ordinal** <ordinal-value> <option> <attribute> <value>

Attribute	Description
<I3v4   I3v6>	Specify <b>I3v4</b> for IPv4 and <b>I3v6</b> for IPv6.
<rule-name>	Subscriber ACL rule name.
<ordinal-value>	The mandatory ordinal value is used to differentiate multiple rules within the rule set.
action	The desired action, which can be either <b>permit</b> , <b>drop</b> or <b>http-redirect</b> .
priority <priority-value>	The priority of the rule, where the lower value has a higher priority.
match	The match criteria.

### Configuring Subscriber Filter Match Criteria

Syntax:

**set forwarding-options subscriber-acl** <I3v4|I3v6> **rule** <rule-name> **ordinal** <ordinal-value> **match** <attribute> <value>

Attribute	Description
destination-ipv4-prefix <destination-ipv4-prefix>	Packets are matched when the IPv4 destination address is within the defined prefix.
destination-ipv4-prefix-list <destination-ipv4-prefix-list>	Packets are matched when the IPv4 destination address is within one of the prefixes listed in the defined prefix list.
destination-ipv4-subscriber-prefix <true>	Packets are matched when the IPv4 destination address is within the dynamically assigned subscriber IPv4 address prefix (sometimes, referred to framed prefix). Consequently, this option shares similarity to the <b>destination-ipv4-prefix</b> , where the prefix is automatically set to the dynamic subscriber prefix. This option is allowed only in the egress (downstream) direction.

Attribute	Description
destination-ipv6-prefix <destination-ipv6-prefix>	Packets are matched when the IPv6 destination address is within the defined prefix.
destination-ipv6-prefix-list <destination-ipv6-prefix-list>	Packets are matched when the IPv6 destination address is within one of the prefixes listed in the defined prefix list.
destination-ipv6-subscriber-prefix <true>	Packets are matched when the IPv6 destination address is within the dynamically assigned subscriber IPv6 address prefix (sometimes, referred to framed prefix). Consequently, this option shares similarity to the destination-ipv4-prefix, where the prefix is automatically set to the dynamic subscriber prefix. This option is allowed only in the egress (downstream) direction.
destination-ipv6-delegated-subscriber-prefix <destination-ipv6-delegated-subscriber-prefix>	This option is similar to the <b>destination-ipv6-subscriber-prefix</b> using the dynamically delegated prefix instead.
source-ipv4-prefix <source-ipv4-prefix>	Packets are matched when the IPv4 source address is within the defined prefix.
source-ipv4-prefix-list <source-ipv4-prefix-list>	Packets are matched when the IPv4 source address is within one of the prefixes listed in the defined prefix list.
source-ipv4-subscriber-prefix <source-ipv4-subscriber-prefix>	Packets are matched when the IPv4 source address is within the dynamically assigned subscriber IPv4 address prefix (sometimes, referred to framed prefix). Consequently, this option shares similarity to <b>source-ipv4-prefix</b> , where the prefix is automatically set to the dynamic subscriber prefix. This option is allowed only in the ingress (upstream) direction.
source-ipv6-prefix <source-ipv6-prefix>	Packets are matched when the IPv6 source address is within the defined prefix.
source-ipv6-prefix-list <source-ipv6-prefix-list>	Packets are matched when the IPv6 source address is within one of the prefixes listed in the defined prefix list.

Attribute	Description
source-ipv6-subscriber-prefix <source-ipv6-subscriber-prefix>	Packets are matched when the IPv6 source address is within the dynamically assigned subscriber IPv6 address prefix (sometimes, referred to framed prefix). Consequently, this option shares similarity to <b>source-ipv4-prefix</b> , where the prefix is automatically set to the dynamic subscriber prefix. This option is allowed only in the ingress (upstream) direction only.
source-ipv6-delegated-subscriber-prefix true	This option is similar to the <b>source-ipv6-subscriber-prefix</b> using the dynamically delegated prefix instead. Note: To disable this configuration, use the <b>delete</b> form of the command.
source-l4-port <source-l4-port>	Packets are matched based on the layer 4 source port (TCP or UDP port).
destination-l4-port <destination-l4-port>	Packets are matched based on the layer 4 destination port (TCP or UDP port).
ip-protocol <ip-protocol>	Packets are matched depending on the IP protocol (TCP or UDP). However, this option is not compatible with the MPLS-encapsulated traffic. Consequently, filtering based on IP protocol is not possible for MPLS traffic received from the core. For instance, it is feasible to drop all traffic to port 80, but it is not possible to selectively drop only TCP traffic while permitting UDP traffic when receiving traffic with an MPLS label.
subscriber-ifl <true>	Packets are matched based on incoming subscriber IFL. This option is allowed only in the ingress (upstream) direction.

## Configuring Subscriber Filter Actions

Syntax:

```
set forwarding-options subscriber-acl <|3v4||3v6> rule <rule-name> ordinal <ordinal-value> action <attribute> <value>
```



Attribute	Description
permit	Forward packets.
drop	Silently discard packets.
http-redirect true	Specify true to enable the redirect service. Note: To disable http-redirect, use the <b>delete</b> form of the command.

The following example shows an IPv4 subscriber filter configuration in which the applied ACL is **ipv4-acl-in**.

```

supervisor@rtbrick: cfg> show config forwarding-options subscriber-acl 13v4
{
  "rtbrick-config:13v4": {
    "rule": [
      {
        "rule-name": "ipv4-acl-in",
        "ordinal": [
          {
            "ordinal-value": 1,
            "match": {
              "destination-l4-port": 80,
              "ip-protocol": "TCP"
            },
            "action": {
              "http-redirect": "true"
            },
            "priority": 1001
          }
        ]
      }
    ]
  }
}

```

## Attaching the ACL Rule

Syntax:

**set access service-profile profile-name** <profile-name> <attribute> <value>

Attribute	Description
<profile-name>	Service profile name.
<http-redirect>	HTTP redirect service configuration.
<url>	HTTP redirect target URL.
<acl>	Subscriber ACL (filter) configuration.

Attribute	Description
<ipv4-acl-in>	IPv4 upstream ACL (ingress from subscriber).
<ipv4-acl-out>	IPv4 downstream ACL (egress to subscriber).
<ipv6-acl-in>	IPv6 upstream ACL (ingress from subscriber).
<ipv6-acl-out>	IPv6 downstream ACL (egress to subscriber).

### 5.5.3. Subscriber Filters Operational Commands

#### Subscriber Filters Show Commands

The show commands provide detailed information about the subscriber filter.

#### Subscriber ACL (Filter) Information

The `show subscriber <id> acl` command provides a comprehensive list of all ACL instances initiated for the subscriber, including RBFS Subscriber Filters and Ascend Data Filters (ADF). Additionally, this command provides the option to view detailed information for each filter instance by appending the corresponding filter name. Consequently, the filters are displayed with all variables, such as `destination-ipv4-subscriber-prefix`, replaced by their actual prefixes for clarity.

#### Syntax:

**show subscriber** <subscriber-id> **acl** <acl-name>

#### Example:

```
supervisor@rtbrick: op> show subscriber 1369375761697341441 acl ipv4-acl-in-ipoe-
lag-1/1369375761697341441
Rule: ipv4-acl-in-ipoe-lag-1/1369375761697341441
  ACL type: 13v4
  Ordinal: 1
  Priority: 1001
  Match:
    Direction: ingress
    Destination L4 port: 80
    IP protocol: TCP
  Action:
    HTTP-redirect: True          URL: www.rtbrick.com
```

## 5.6. Lawful Interception

### 5.6.1. Lawful Interception Overview

Lawful Interception (LI) is a legal requirement in most of the countries. It enables the legal authorities to obtain communications network data for analysis or evidence. It is a method of intercepting certain data-streams of end-users in both directions, and tunnel the intercepted traffic to a Mediation Device (MD) with information about direction of capture and reference to the intercepted connection.

Leaf node is the Point of Interception (POI) and MD is the final Point of Collection (POC).

### Components of Lawful Interception

The figure below shows the different components of the LI solution.

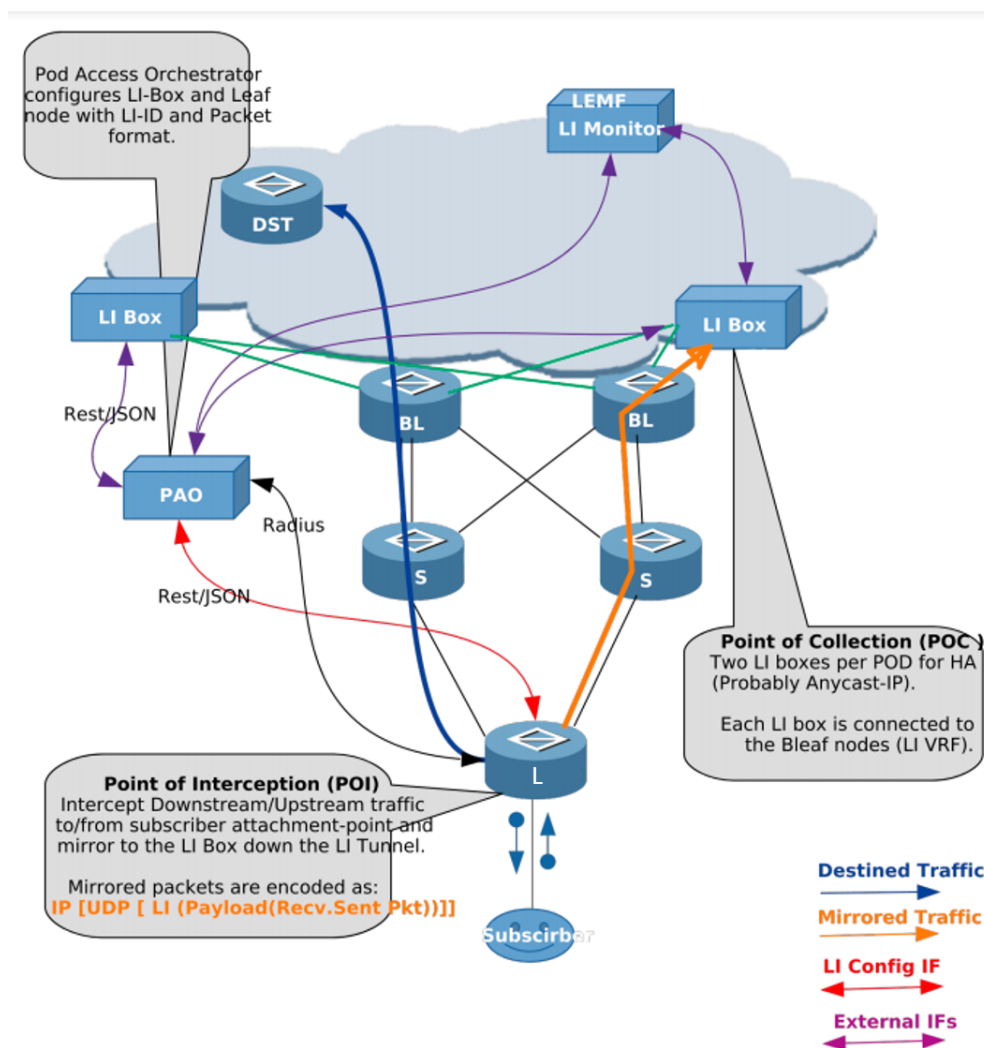

## Definitions

### L

Leaf node in the POD which is connected to subscribers.

### S/BL

Spine and Border Leaf in the POD, which can be replaced with just one node.

### LI Box

Lawful Intercept Box, which communicates to Law Enforcement Agency (LEMF) and relays mirrored traffic. Two LI boxes per POD are connected for redundancy.

### PAO

POD Access Orchestrator, which configures the LI Box and network nodes with LI configurations.

### DST

Destination node for traffic from subscribers.

## Abbreviations

Abbreviation	Definition
LI	Lawful Interception
POI	Point of Interception
POC	Point of Collection
PAO	Pod Access Orchestrator
LIMS	Lawful Interception Management System
VRF	Virtual Routing Instance
LEMF	Lawful Enforcement Monitoring Facility
Leaf	Access node
PPPoE	Point to Point Protocol over Ethernet
L2TP	Layer 2 Tunnelling Protocol
MPLS	Multi Protocol Label Switching

## LIX1 Interface

X1 is the interface that enables the Lawful Interception system to allocate tasks to an administrative function (ADMF), aka LIMS (Lawful Interception Management System). The ADMF is a tool that enables or disables LI per subscriber session. In addition, it configures the destination that receives the intercepted traffic.

RBFS uses the LI X1 API daemon (lix1d), which performs the following functions:

- Configure delivery destination for mirrored subscriber traffic.
- Enable or disable an LI measure for a subscriber session.
- List the applied LI measures.
- Respond to X1 heartbeat message.

## Guidelines & Limitations

- The unidentified LI traffic is subject to the following limitations when using more than seven UDP ports.

Currently, there is a restriction on UDP destination ports, which are limited to 7. The IP destination addresses (IP1 through IPn) can utilize any of the seven ports. The distribution of these seven ports is determined by the order in which requests are received, with priority given to those who arrive first.

- All upstream packets, regardless of whether they were dropped or not, are intercepted and mirrored to the LI collection entity.

The following are some of the reasons that could cause dropped packets, but LI will still intercept and mirror traffic to LI collection.

A routing failure occurred. This is unlikely as there is a default route to the spine.

The RPF check has failed.

The policer was dropped.

The ACL/filter was dropped.



This limitation does not apply to downstream packets.

## Supported Platforms

Not all features are necessarily supported on each hardware platform. Refer to the

*Platform Guide* for the features and the sub-features that are or are not supported by each platform.

## 5.6.2. LI Encapsulation

Qumran-MX (BCM) supports LI with 32 bits shim header: SHIMoUDPoIPoETH

### Packet Format Encoding

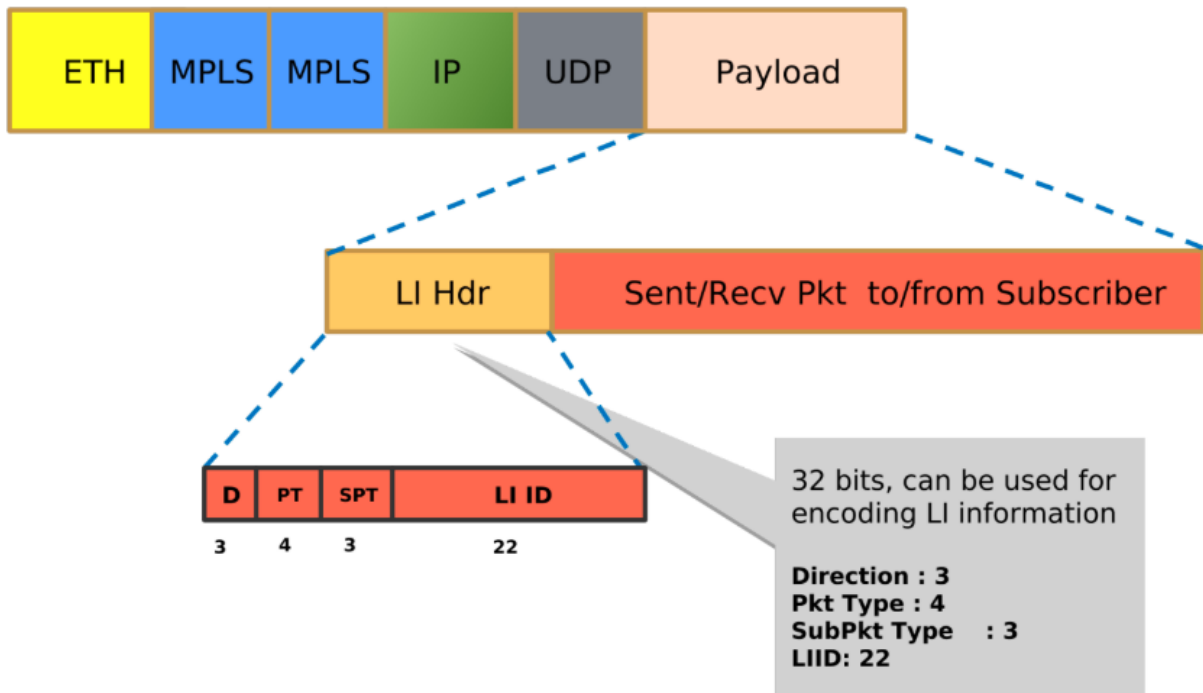

Figure 21. Packet Format Encoding

### Payload Direction

Value	Payload Direction
0	Reserved for keepalive mechanism
2	Intercepted data or event was sent to target (downstream)
3	Intercepted data or event was sent from target (upstream)

### Mapping Payload Format

Value	Payload Format
0-3	Reserved (unused)

Value	Payload Format
4	Unknown, Not able to decide the PT
5	IPv4 packet (not used)
6	IPv6 packet (not used)
7	Ethernet Frame (used for Lawful Interception)

### Sub-payload Format (Type)

The sub-payload formats are:

1. Single VLAN tag
2. Double VLAN tag
3. Untagged

### 5.6.3. LIX1 Configuration

In this section, you can find the configurations that pertain to the LIX1 interface.

Syntax:

**set lawful-intercept protocol** <protocol-name[1-2]> <attribute> <value>

Attribute	Description
<protocol-name[1-2]>	Enables lawful intercept on the switch. Supported Value: x1.
administrative-function-endpoint <administrative-function-endpoint[1-128]>	Specifies the ADMF endpoint URL for sending requests.
administrative-function-id <administrative-function-id[1-128]>	Specifies the LI Administration Function identifier.
mediation-device-instance <mediation-device-instance[1-64]>	Specifies the instance that hosts the mediation devices.
mutual-tls	Global mutual TLS configuration.

Attribute	Description
mutual-tls client authentication <certificate-name[1-64]>	(Optional) Name of the certificate.
mutual-tls client authentication <certificate-name[1-64]> certificate <certificate[1-8192]>	Specifies the certificate PEM data in base64 encoding. If this value is not specified, it defaults to server certificate.
mutual-tls client authentication <certificate-name[1-64]> key-encrypted-text <key-encrypted-text[4-16419]>	Specifies the Certificate key in an encrypted format.
mutual-tls client authentication <certificate-name[1-64]> key-plain-text <key-plain-text[1-8192]>	Specifies the Certificate key in base64 encoding. If this value is not specified, it defaults to server authentication key.
mutual-tls client root-ca <root-ca[1-8192]>	(Optional) Specifies the trusted CA in base64 encoding. This is mandatory for a self-signed certificate.
mutual-tls server certificate <certificate[1-8192]>	Specifies the certificate PEM data in base64 encoding.
mutual-tls server client-ca <client-ca[1-8192]>	Specifies the trusted client CAs in base64 encoding.
mutual-tls server key <key-encrypted-text[4-16419]>	Sepcifies the certificate key in base64 encoding.
network-element-id <network-element-id[1-128]>	The network element ID of the network element in the ADMF.



Attribute	Description
network-element-path <network-element-path[1-128]>	(Optional) The context-path for all incoming protocol requests. Default: /X1/NE.
sync-timeout <5-60>	(Optional) The maximum interval for completing protocol requests synchronously in seconds. Default: 5.
async-timeout <10-120>	(Optional) The maximum interval for completing protocol requests asynchronously in seconds. Default: 15.
hold-time <60-86400>	<p>(Optional) Specifies the hold time in seconds for the LI tasks if no keepalive messages are seen from ADMF. Default: 3600.</p> <div style="display: flex; align-items: center; margin-top: 10px;">  <p>If both sync and async-timeout are configured, async-timeout has to be at least twice the value of sync-timeout.</p> </div>

## Invoking LI with CURL

As shown in the example below, you can use CURL to invoke LI.

```
sudo curl --location 'http://localhost/hostconfd/api/v1/li' --header 'Content-Type: application/json' --data '<Insert data>' --unix-socket /var/run/rtbrick/hostconfd_sock/unix.sock -v
```

### 5.6.4. Enabling Lawful Interception



- RBFS hides information about lawful intercepts from all but the most privileged users. An administrator must set up access rights to enable privileged users to access lawful intercept information.
- LI can be enabled for both L2TP and PPPoE subscribers.

### RADIUS Lawful Interception

All of the following attributes must be present in RADIUS access-accept or CoA

request to control Lawful Interception (LI) via RADIUS. Those attributes are salt encrypted using the algorithm described in RFC 2868 for the Tunnel-Password. This encryption algorithm is defined for RADIUS access-accept messages only. To support CoA requests the request authenticator should be replaced with 16 zero bytes which is common industry standard.



RFC and draft compliance are partial except as specified.

The LI action NOOP can be used to obfuscate lawful interception requests (fake requests) to prevent that just the presence of those attributes indicates that a subscriber is intercepted. LI requests via RADIUS will show up in the same table as requests via REST or HTTP RPC API (secure.lawful.access.1.li\_request).



The failed LI activations are not signalled via RADIUS to prevent that just the presence of CoA response NAK shows that LI request is not fake (action NOOP).

### VSA 26-50058-140 - RtBrick-LI-Action (salt encrypted integer)

Value	Code	Description
NOOP	0	No action / Ignore LI request
ON	1	Start LI / Add LI request
OFF	2	Stop LI / Delete LI request

### VSA 26-50058-141 - RtBrick-LI-Identifier (salt encrypted integer)

Device unique lawful interception identifier (LIID) within the range from 1 to 4194303.

### VSA 26-50058-142 - RtBrick-LI-Direction (salt encrypted integer)

Value	Code	Description
INGRESS	1	Ingress mirroring only (from subscriber)
EGRESS	2	Egress mirroring only (to subscriber)
BOTH	3	Bidirectional mirroring (from and to subscriber)

**VSA 26-50058-143 - RtBrick-LI-MED-Instance (salt encrypted string)**

Routing instance through which the mediation device is reachable.

**VSA 26-50058-144 - RtBrick-LI-MED-IP (salt encrypted IPv4 address)**

IPv4 address of the mediation device.

**VSA 26-50058-145 - RtBrick-LI-MED-Port (salt encrypted integer)**

UDP port between 49152 and 65535 set in the mirrored traffic

**RBFS Operational State API**

The RBFS Operational State API provides endpoints for enabling and disabling LI on a per-subscriber basis:

- A HTTP POST request to `/subscribers/{subscriber_id}/enableLI?id={li_id}&direction={li_direction}&med_ip={med_ip}&med_instance={med_instance}&med_port={med_port}` enables LI for the specified subscriber
- A HTTP POST request to `/subscribers/{subscriber_id}/disableLI?id={li_id}` disable LI for the specified subscriber

The table below lists the request parameters:

Parameter Name	Description
subscriber_id	Subscriber identifier that is generated by RBFS, for example, 72339069014638701.
id	Identifier for Lawful Interception. This is unique Identifier used by mediation device to identify the intercepted subscriber. The range can be between 1 to 4194303.
direction	LI direction. Values are: INGRESS, EGRESS, BOTH.
med_instance	VRF instance through the which the mediation device is reachable.
med_ip	IPv4 address of the mediation device
med_port	UDP port(MD)(49152-65535), mirrored traffic is forwarded



All parameters are mandatory to enable LI.

## Request Examples

### Enabling LI

The example below shows a `curl` command to enable LI:

```
curl -i -H "Content-Type: application/json" -X POST -d
http://198.51.100.76:19091/api/v1/rbfs/elements/rtbrick/services/opsd/proxy/subscr
ibers/72339069014639042/enableLI?id=66666&direction=BOTH&med_instance=libox&med_ip
=10.0.0.1&med_port=49153
```

### Disabling LI

The example below shows a `curl` command to disable LI.

```
curl -i -H "Content-Type: application/json" -X POST -d
http://198.51.100.76:19091/api/v1/rbfs/elements/rtbrick/services/opsd/proxy/subscr
ibers/72339069014639042/disableLI?id=66666
```

## 5.7. L2BSA

### 5.7.1. L2BSA Overview

Layer 2 Bitstream Access (L2BSA) refers to a scenario in which a service provider makes his access infrastructure available to other service providers. These are retail service providers who provide their Internet services. In Germany, this service is mandated by the Federal Network Agency (German: Bundesnetzagentur or BNetzA) which is the regulatory office for electricity, gas, telecommunications, post, and railway markets. It is a federal agency of the Federal Ministry for Economic Affairs and Energy and is headquartered in Bonn, Germany.

The definition of the L2BSA service was defined by the so-called NGA Forum, an advisory board founded in May 2010 by the Bundesnetzagentur for promoting dialogue between the Bundesnetzagentur, network operators, manufacturers, states and local authorities on NGA rollout.

[https://www.bundesnetzagentur.de/EN/Areas/Telecommunications/Companies/MarketRegulation/NGAForum/NGAForum\\_node.html](https://www.bundesnetzagentur.de/EN/Areas/Telecommunications/Companies/MarketRegulation/NGAForum/NGAForum_node.html)

The L2BSA specification defines two interfaces, the so-called U interface (User Interface) at the customer location and the A10-NSP interface (A10 Network

Service Provider) between the service provider networks. Those interface types were originally introduced in the Broadband Forum TR-101 (Migration to Ethernet-based Broadband Aggregation).

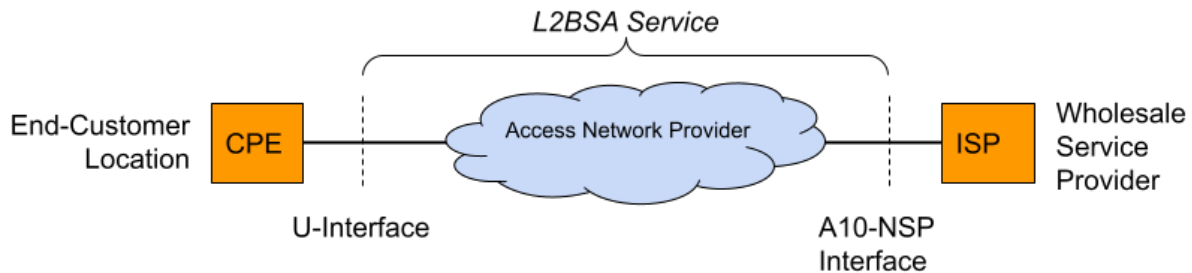

Figure 22. L2BSA Interfaces

The U interface is defined as a transparent Layer 2 interface which can be used with or without VLAN tags by the wholesale service providers. This means that some CPE will send their traffic untagged while another CPE is configured for tagged traffic which needs to be transparently forwarded between the U interface and the A10-NSP interface.

The A10-NSP interface is defined as a link aggregation bundle interface with one or more interfaces and LACP enabled or disabled. All traffic on this interface is at least single-tagged with the so-called S-VLAN tag which identifies the U interface. This limits the amount of L2BSA services to 4094 per A10-NSP interface caused by the usable VLAN range. Therefore some providers need multiple A10-NSP interfaces if they need to address more than the 4094 services.

The term A10 relates to the end-to-end ADSL network reference model depicted in the figure below. The Core Network reference model is a subset of the end-to-end architecture; it is composed of two functional blocks and three reference points. The Access Node and the Regional Broadband Network are the two functional blocks. U, V and A10 are the three reference points.

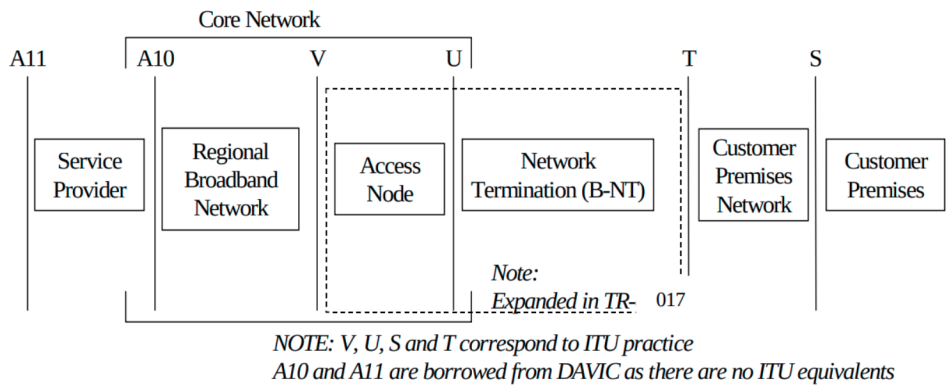

Figure 23. TR-025

Source: <https://www.broadband-forum.org/download/TR-025.pdf>

The mapping between the U interface and A10-NSP/S-VLAN is managed by the L2BSA service provider and typically changes frequently triggered by re-provisioning actions. Therefore all PPPoE discovery, as well as DHCPv4/v6 packets, must be enriched with additional line identification headers (Agent-Remote-Id, Agent-Circuit-Id, Actual-Data-Rate, ...) by the L2BSA service provider in the upstream direction (from U to A10-NSP interface) to allow the wholesale provider to identify the actual U interface for traffic received on the A10-NSP interface. This functionality is referred to as the intermediate agent functionality.

The U interface is terminated on the access node which might be an OLT for fiber-based access or MSAN for xDSL, therefore the U interface can also be called the customer access line or port. The access node will add additional VLAN for each access line to uniquely identify them between the access node and leaf switch. This VLAN is called the ANP tag (Access-Node-Port).

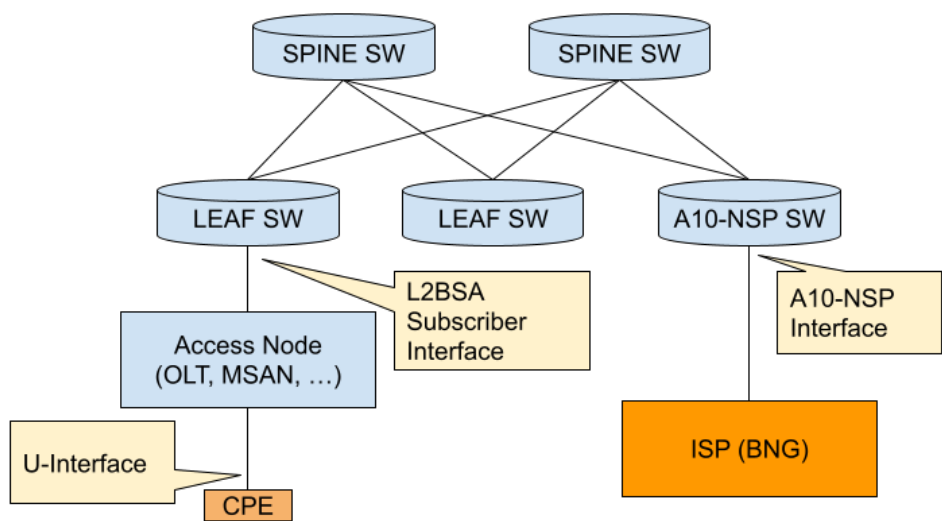

Figure 24. L2BSA Fabric

For L2BSA services all traffic received with a given ANP tag will be transparently forwarded to the corresponding A10-NSP interface via Layer 2 cross-connect (L2X) services. We introduce a new subscriber type for L2BSA in our RBFS access infrastructure to manage those services on the leaf switches and to allow further advanced access services like QoS or subscriber accounting.

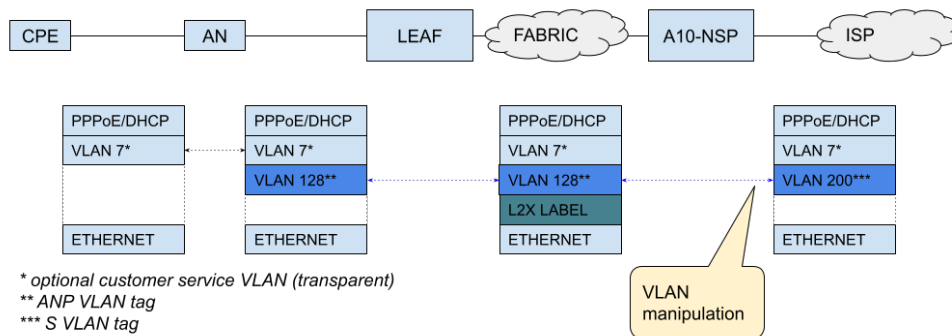

Figure 25. L2BSA Traffic

## L2BSA Services and Subscribers

RBFS distinguishes between L2BSA services and subscribers. L2BSA services are created using the Operational State API ([/l2bsa](#)) stored as ephemeral objects in the configuration daemon. Those objects are excluded from the actual configuration and not restored after reboot. The L2BSA service represents a defined interface to add, update and delete L2BSA services. Those services are managed by external orchestrators or service managers and are not changed or deleted by RBFS.

Adding such an L2BSA service triggers the creation of a corresponding L2BSA subscriber which represents the internal state. Each L2BSA subscriber is a full-access subscriber and therefore most subscriber features will work for L2BSA as well. This includes features like RADIUS authentication, accounting, CoA or dynamic QoS. Each L2BSA subscriber persists as long as the service is still present and also if the subscriber has already been terminated. This allows external applications to collect all states and counters before the subscriber is finally deleted triggered by L2BSA service delete.

## A10-NSP L2X Services

For each L2BSA service, there must also be an A10-NSP L2X endpoint created using the Operational State API ([/a10nsp/l2x](#)).

The A10-NSP endpoint is the place where all VLAN manipulation is done meaning

where ANP and S-VLAN are swapped.

## Supported Platforms

Support for the following underlays are available:

- IS-IS Segment Routing
- BGP Segment Routing



Not all features are necessarily supported on each hardware platform. Refer to the Platform Guide for the features and the sub-features that are or are not supported by each platform.

### 5.7.2. L2BSA Configuration

This document assumes a working base configuration explaining the L2BSA specific additions only.

#### AAA Profile Configuration

Each L2BSA service refers to a mandatory AAA configuration profile as explained in detail in the Subscriber Management Configuration Guide. The following example shows the minimum configuration with authentication and accounting disabled.

```
supervisor@leaf1: cfg> show config access aaa-profile aaa-l2bsa-default
{
  "rtbrick-config:aaa-profile": [
    {
      "profile-name": "aaa-l2bsa-default",
      "authentication": {
        "order": "NONE"
      },
      "accounting": {
        "order": "NONE"
      }
    }
  ]
}
```

#### Intermediate Agent Configuration

##### DEPRECATED!

The functionality of the intermediate agent is designed to be implemented within



the access node, which could be an OLT for fiber-based access or MSAN for xDSL. RBFS is technically prepared to fulfill the role of an intermediate agent in exceptional circumstances where the access node does not offer this function.

Please note that the intermediate agent function is deprecated and will be removed in future releases!

The RBFS intermediate agent is capable of appending headers in the upstream direction but cannot strip them again in the downstream. Consequently, it is compatible only with PPPoE and DHCPv4. For DHCPv4, it should be noted that headers added upstream are not removed downstream if echoed back by the DHCP server, which is the usual behavior.

To enable the intermediate agent function, it must be enabled for each physical interface used by L2BSA services.

```

supervisor@leaf1: cfg> set access l2bsa intermediate-agent interface ifp-0/1/23
<cr>
  pppoe-enable          Enable/disable the L2BSA intermediate agent for PPPoE
Discovery
  dhcpv4-enable        Enable/disable the L2BSA intermediate agent for DHCPv4
  vlan-mode            L2BSA intermediate agent VLAN mode
  inner-vlan-min       Inner VLAN min
  inner-vlan-max       Inner VLAN max
    
```

Attribute	Description
pppoe-enable	This option allows enabling/disabling the intermediate agent function for PPPoE discovery packets.  <b>Default:</b> false (disabled)
dhcpv4-enable	This option allows enabling/disabling the intermediate agent function for DHCPv4 packets.  <b>Default:</b> false (disabled)
vlan-mode	This option enables the intermediate agent function for single, double, or single and double-tagged packets.  <b>Default:</b> SINGLE_DOUBLE <b>Values:</b> SINGLE, DOUBLE, SINGLE_DOUBLE

Attribute	Description
inner-vlan-min/max	This option is applicable for double-tagged packets only and allows limiting the intermediate agent function to a given inner VLAN range.  <b>Default:</b> all

The following common example enables the intermediate agent for all single-tagged PPPoE/DHCPv4 packets and double-tagged PPPoE/DHCPv4 packets with inner VLAN between 1 and 3000.

```

supervisor@leaf1: cfg> show config access l2bsa intermediate-agent
{
  "rtbrick-config:intermediate-agent": {
    "interface": [
      {
        "interface-name": "ifp-0/1/23",
        "inner-vlan-min": 1,
        "inner-vlan-max": 3000,
        "pppoe-enable": "true",
        "dhcpv4-enable": "true"
      }
    ]
  }
}

```

### 5.7.3. L2BSA Operational Commands

The following commands allow to list or clear all L2BSA services from CLI.

```

supervisor@leaf1: op> show l2bsa service
Interface      ANP VLAN      Timestamp
ifp-0/0/1      1000        Mon Aug 30 09:21:14 GMT +0000 2021

supervisor@leaf1: op> clear l2bsa service all
Success

```

L2BSA subscribers can be managed like any other subscriber using the subscriber CLI commands.

```

supervisor@leaf1: op> show subscriber
Subscriber-Id  Interface      VLAN      Type      State
281479271677954  ifp-0/1/23    1000:0    L2BSA    ESTABLISHED

supervisor@leaf1: op> show subscriber filter type L2BSA
Subscriber-Id  Interface      VLAN      Type      State
281479271677954  ifp-0/1/23    1000:0    L2BSA    ESTABLISHED

```

```

supervisor@leaf1: op> show subscriber 281479271677954 detail
Subscriber-Id: 281479271677954
  Type: L2BSA
  State: ESTABLISHED
  Created: Mon Aug 30 09:23:34 GMT +0000 2021
  Interface: ifp-0/1/23
  Outer VLAN: 1000
  IFL: l2bsa-0/0/1/281479271677954
  Username: ifp-0/1/23:1000@l2bsa
  Agent-Remote-Id: DEU.L2BSA.API01
  Agent-Circuit-Id: 0.0.0.0/0.0.0.0 eth 01
  AAA-Profile: aaa-l2bsa-default
  Session-Timeout: 0 (disabled)
  Idle-Timeout: 0 (disabled)
  L2X:
    Instance: default
    Nexthop: 198.51.100.101 (ipv4/labeled-unicast)
    Ingress Label (TX): 1337
    Egress Label (RX): 7331
  Accounting:
    Session-Id: 281479271677954:1630315414
    Start-Time: 2021-08-30T09:23:34.847166+0000
    Interims Interval: 0 seconds

```

The CLI also provides some global intermediate agent function packet statistics about traffic received in the control plane which belong to L2BSA subscribers.

```

supervisor@leaf1: op> show l2bsa intermediate-agent statistics
PPPoE Discovery Sent      : 0
PPPoE Discovery Updated   : 0
PPPoE Discovery Dropped  : 0

```

The sent statistics count all intermediate agent traffic forwarded back to L2X while updated only counts those which are also updated or enriched by access line information. Dropped are those packets received but dropped by the L2BSA subscriber state which might be the case if the L2BSA subscriber is still present but in a terminating state.

## 5.7.4. L2BSA Operational State API

The API is split into the L2BSA and A10-NSP L2X service API. Details about those API endpoints, schema and attributes can be found in the official RBFS Operational State OpenAPI documentation.

### L2BSA Services API

Each L2BSA service is uniquely identified by physical interface name (IFP) and ANP

VLAN identifier. All other attributes of L2BSA services can be changed dynamically by replacing the existing service object by doing a full update meaning that updates must include all attributes and RBFS will automatically recognize the changes to the last version to apply those incrementally.

Endpoint	Description
GET /l2bsa	This endpoint returns a list of all L2BSA services.
PUT /l2bsa	This endpoint replaces all L2BSA services on the system by adding new ones, updating existing and deleting those not included in the request but present on the system. Therefore this endpoint can be used to delete all services if an empty list is provided in the request body.
GET /l2bsa/{ifp_name}	This endpoint returns a list of all L2BSA services on the given physical interface (IFP).
PUT /l2bsa/{ifp_name}	This endpoint works similarly to <b>PUT /l2bsa</b> but affects only services matching the given physical interface (IFP). Therefore this endpoint can be used to delete all services of a given physical interface if an empty list is provided in the request body.
GET /l2bsa/{ifp_name}/{anp}	This endpoint returns a single L2BSA service or <b>404</b> if no matching service is found.
PUT /l2bsa/{ifp_name}/{anp}	This endpoint adds or updates a single L2BSA service.
DELETE /l2bsa/{ifp_name}/{anp}	This endpoint deletes a single L2BSA service.

The following example shows an L2BSA service request body with only the mandatory attributes set.

```
{
  "ifp_name": "ifp-0/0/1",
  "anp_vlan": 128,
  "aaa_profile_name": "aaa-l2bsa-default",
  "l2x": {
    "ingress_nexthop": "2001:db8:0:30::",
    "ingress_service_label": 1001,
    "egress_service_label": 1002
  }
}
```

The L2X ingress next-hop is typically the fabric loopback IPv4 or IPv6 address of the corresponding switch where the corresponding A10-NSP L2X service is placed. The ingress label is the upstream service label added for traffic sent to the corresponding next-hop (sent label). The egress label is the downstream service label where traffic sent from the next-hop is expected to be received (receive label). This label must be unique per switch.



Only labels greater than 100.000 should be used for the L2X service labels because labels between 16 - 100.000 are reserved by other applications. L2X service labels must not conflict with other L2X service labels and the same label can be used for downstream and upstream.

L2BSA supports also dynamic QoS which can be controlled by RADIUS if enabled or directly via API as shown in the following example.

```
{
  "ifp_name": "ifp-0/0/1",
  "anp_vlan": 128,
  "aaa_profile_name": "aaa-l2bsa-default",
  "l2x": {
    "ingress_nexthop": "2001:db8:0:30::",
    "ingress_service_label": 1001,
    "egress_service_label": 1002
  },
  "qos": {
    "qos_profile_name": "l2bsa-qos-default",
    "parent_scheduler": "pon1",
    "shaper":
    "name=shaper_session,high=14000,low=2000;name=shaper_voice,high=2000",
    "policer": "level=4,cir=1m,cbs=256;level=3,cir=2m,cbs=512",
    "queue": "name=BestEffort,size=65000;name=Voice,size=20000"
  }
}
```

The QoS configuration profile is used to instantiate the QoS resources for the subscriber including schedulers, queues and shapers. This profile can be set using the `qos_profile_name` attribute. All dynamic QoS settings like MFC, queue sizes, shaper and policer rates will be reset if this attribute is present also if not changed. Additional shaper or policer settings included will be applied to the new QoS configuration after reset.

The assigned shaper instances can be updated using the `shaper` attribute which will apply to the QoS instance of the corresponding subscriber-only, but not to the other subscribers using the same QoS profile. It is only possible to update existing shapers dynamically but it is not possible to create a new shaper.

```
"shaper": "<shaper-name>, <high-kbps>, <low-kbps>; <shaper-name>, ..."
```

This attribute can be also used as a key-value list which is automatically recognized by RBFS.

```
"shaper": "name=<shaper-name>, high=<high-kbps>, low=<low-kbps>; /..."
```

The **policer** attribute is also a string that contains a list of multiple policer-level settings separated by a semicolon. Each set contains a level, cir, cbs, pir, pbs, max-cir and max-pir separated by a comma.

```
"policer": "<level>, <cir>, <cbs>, <pir>, <pbs>, <max-cir>, <max-pir>; <level>..."
```

Example:

```
"policer": "1,2000,200;2,8000,800;3,0,800;4,0,800"
```

```
level: 1 (highest priority) to 4 (lowest priority)
cir: ingress policer committed information rate (kbps)
cbs: ingress policer committed burst size (kbps)
pir: ingress policer peak information rate (kbps)
pbs: ingress policer peak burst size (kbps)
max-cir: max ingress policer committed information rate (kbps)
max-pir: max ingress policer peak information rate (kbps)
```

If PIR and PBS are not defined, the values from CIR and CBS are used as PIR and PBS as well. The max CIR and max PIR attributes are optional default set to unlimited.

This attribute can be also used as a key-value list which is automatically recognized by RBFS.

```
"policer": "level=<level>, cir=<cir>, cbs=<cbs>, pir=<pir>, pbs=<pbs>, max-cir=<max-cir>, max-pir=<max-pir>; /..."
```

Example:

```
"policer": "level=4, cir=1m, cbs=256; cir=2m, cbs=512, level=3"
```

The **queue** attribute is a string that contains a list of multiple queue settings separated by a semicolon. Each queue setting contains a queue name and queue size in bytes separated by a comma.

```
"queue": "<queue-name>, <size-bytes>; <queue-name>, <size-bytes>; /..."
```

This attribute can be also used as a key-value list which is automatically recognized

by RBFS.

```
"queue": "name=<queue-name>,size=<size-bytes>;name=..."
```



The subscriber management infrastructure does not check if a referenced QoS profile, shaper, queue or policer exists or not. This is handled by forwarding infrastructure which continues processing the subscriber QoS settings as soon as the missing resource was added.

The parent scheduler element of the scheduler map assigned to the subscriber can be selected with the `parent_scheduler` attribute. If not present, the scheduler map will be directly bound to the local IFP where the session is established. The parent scheduler can be only set at the beginning and must not be changed.



Providing a QoS parent scheduler that is not present on the corresponding IFP will lead to the black howling of all egress data traffic.

The optional `access_line_info` attribute contains the access line identification and characteristics attributes used by the intermediate agent function. A detailed list of all supported line attributes and values can be found in the official RBFS Operational State OpenAPI documentation.



For access line attributes there is a difference between attributes not present or set to zero. Those not present will be also not added by the intermediate agent function whereas those set to zero will be added by the intermediate agent function with value also set to zero.

### Example:

```
/usr/bin/curl --location --request PUT
'http://198.51.100.35:19091/api/v1/rbfs/elements/leaf1/services/opsd/proxy/l2bsa/i
fp-0%2f0%2f1/128' --header 'Content-Type: application/json' --data-raw '{
  "ifp_name": "ifp-0/0/1",
  "anp_vlan": 128,
  "aaa_profile_name": "aaa-l2bsa-default",
  "l2x": {
    "ingress_nexthop": "2001:db8:0:30::",
    "ingress_service_label": 1001,
    "egress_service_label": 1002
  },
  "qos": {
```

```

    "gos_profile_name": "l2bsa-qos-default",
    "parent_scheduler": "pon1",
    "shaper":
"name=shaper_session,high=14000,low=2000;name=shaper_voice,high=2000",
    "policer": "level=4,cir=1m,cbs=128;level=2,cir=1m,cbs=128",
    "queue": "name=BestEffort,size=65000;name=Voice,size=20000"
  },
  "access_line_info": {
    "agent_circuit_id": "0.0.0.0/0.0.0.0 eth 0/0",
    "agent_remote_id": "DEU.RTBRICK.L2BSA01",
    "upstream": {
      "actual_rate": 2048
    },
    "downstream": {
      "actual_rate": 16235
    },
    "pon_type": "GPON"
  }
}'

```

## L2BSA Subscribers API

The existing subscriber API was extended to do some common actions using the L2BSA physical interface name (IFP) and ANP VLAN identifier instead of the subscriber-id.

Endpoint	Description
GET /subscribers/l2bsa/{ifp_name}/{ anp}	This endpoint is an alias for <a href="#">GET /subscribers/{subscriber_id}</a> returning detailed subscriber information or <a href="#">404</a> if no matching subscriber is found.
DELETE /subscribers/l2bsa/{ifp_name}/{ anp}	This endpoint is an alias for <a href="#">DELETE /subscribers/{subscriber_id}</a> which terminates a matching L2BSA subscriber.
GET /subscribers/l2bsa/{ifp_name}/{ anp}/adjusted-accounting	This endpoint is an alias for <a href="#">GET /subscribers/{subscriber_id}/adjusted-accounting</a> returning the adjusted accounting information or <a href="#">404</a> if no matching subscriber is found.

## A10-NSP L2X Services API

Endpoint	Description
GET /a10nsp/l2x	This endpoint returns a list of all A10-NSP L2X services.



Endpoint	Description
PUT /a10nsp/l2x	This endpoint replaces all A10-NSP L2X services on the system by adding new ones, updating existing and deleting those not included in the request but present on the system. Therefore this endpoint can be used to delete all services if an empty list is provided in the request body.
GET /a10nsp/l2x/{lag_interface_name}	This endpoint returns a list of all A10-NSP L2X services on the given LAG interface.
PUT /a10nsp/l2x/{lag_interface_name}	This endpoint works similarly to <a href="#">PUT /a10nsp/l2x</a> but affects only services matching the given LAG interface. Therefore this endpoint can be used to delete all services of a given LAG interface if an empty list is provided in the request body.
GET /a10nsp/l2x/{lag_interface_name}/{s_anp}	This endpoint returns a single A10-NSP L2X service or <b>404</b> if no matching service is found.
PUT /a10nsp/l2x/{lag_interface_name}/{s_anp}	This endpoint adds or updates a single A10-NSP L2X service.
DELETE /a10nsp/l2x/{lag_interface_name}/{s_anp}	This endpoint deletes a single A10-NSP L2X service.

The following example shows an A10-NSP L2X service request body with only the mandatory attributes set.

```
{
  "lag_interface_name": "lag-1",
  "s_vlan": 100,
  "anp_vlan": 128,
  "l2x": {
    "ingress_nexthop": "2001:db8:0:40::",
    "ingress_service_label": 1002,
    "egress_service_label": 1001
  }
}
```

The L2X ingress next-hop is typically the fabric loopback IPv4 or IPv6 address of the corresponding switch where the corresponding L2BSA service is placed. The ingress label is the upstream service label added for traffic sent to the corresponding next-hop (send label). The egress label is the downstream service label where traffic sent from the next-hop is expected to be received (receive label). This label must be unique per switch.



Only labels greater than 100000 should be used for the L2BSA service labels because labels between 16 - 100000 are reserved by other services. L2BSA service labels must not conflict with other L2X service labels and the same label can be used for downstream and upstream.

### Example:

```
/usr/bin/curl --location --request PUT
'http://198.51.100.35:19091/api/v1/rbfs/elements/a10nsp-
sw1/services/opsd/proxy/a10nsp/l2x/lag-1/100' \
--header 'Content-Type: application/json' \
--data-raw '{
  "lag_interface_name": "lag-1",
  "s_vlan": 100,
  "anp_vlan": 128,
  "l2x": {
    "ingress_nexthop": "2001:db8:0:40::",
    "ingress_service_label": 1002,
    "egress_service_label": 1001
  }
}'
```



- L2BSA supports both PPPoE and IPoE subscribers.
- L2BSA supports DHCPv4 and DHCPv6 protocols.

## 5.8. Redundancy

### 5.8.1. RBFS Redundancy for Subscriber Groups

#### Overview

Node outages and link failures that may occur on an access network can bring down the subscriber services. These network outages affect critical workloads and continuity of business. So, it is essential to set up a network that is resilient and responds quickly to the events and protect the network from outages.

The following diagram represents a simple access network without redundancy.

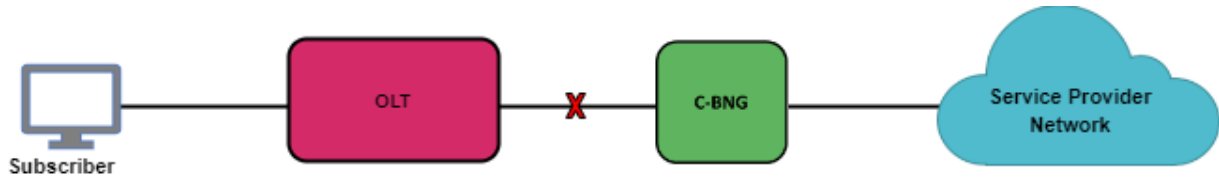

RBFS Redundancy protects subscriber services from node or link outages. It provides mechanisms to enhance network resiliency that enables subscriber workloads to remain functional by ensuring a reliable switchover in the event of a node or link outage. With RBFS Redundancy, if one node goes down due to node or link failure, another node can automatically take over the services.



RBFS currently supports redundancy for IPoE subscribers through a hot-standby mode.

## Understanding RBFS Redundancy

RBFS Redundancy protects subscriber groups using an active-standby node cluster model. In the active-standby node cluster, the active node (for a subscriber group) performs subscriber services. The standby device mirrors concurrent subscriber state data from the active peer (for that redundancy session). Both the nodes, paired for redundancy, keep sending 'keepalive' messages to each other to check the health status. RBFS Redundancy is centered around subscriber groups, known as redundancy sessions.



The document uses the term C-BNG throughout the document. C-BNG stands for consolidated BNG. Unlike the spine-leaf topology, where the functionalities are distributed to spine platforms and leaf platforms separately based on their roles, C-BNG platform includes all functionalities together in a single platform.



RBFS Redundancy is not supported on spine-leaf network topology as the RBFS spine-leaf topological architecture itself innately provides a redundant and resilient network.

## Inter-BNG Connectivity

C-BNG platforms, paired for redundancy, are connected with a Redundancy (RD) TCP link. This RD TCP connection can be formed either directly or through the core network. It uses IS-IS (for unicast reachability) and LDP (for labeled unicast

reachability) between the active and standby nodes. The link between the C-BNG pairs establishes connectivity and the link is used to send 'keepalive' messages and data mirroring for subscriber state synchronization.

If the link goes down, the Keepalive messages cannot be exchanged between the C-BNGs and the C-BNGs move to the standalone state only after the hold-timer expires and the previously synchronized subscriber session data becomes invalid.

If the C-BNG pairs are connected through the core network, then a core network failure can impact redundancy. However, if the inter-BNG connection is direct or through a different path that doesn't rely on the core, redundancy is not impacted by core network failure.

In a scenario, when a new lag is configured for redundancy with the same redundancy session ID, it works for the same session. If any of the lag goes down, a switchover happens.

## **Redundancy Session**

Redundancy session is a binding mechanism that is used to pair C-BNGs for redundancy. RBFS Redundancy allows grouping of subscribers, under a redundancy session and each redundancy session is represented by a redundancy session ID. Simply, an RBFS Redundancy session represents a redundancy group of subscribers. A redundancy session enables linking the LAG with that particular redundancy session (subscriber group). When you define a value for the redundancy session ID, this ID should be unique and the same for both redundancy pairs. When two nodes get the same session ID, they recognize each other as the peer nodes for a particular redundancy session (subscriber group). The TCP session establishment between the nodes occurs after the pairing with the redundancy session ID. Once the TCP session is established, the nodes use this channel for subscriber data mirroring and synchronization and for health status monitoring.

A C-BNG chassis can contain multiple redundancy sessions. Multiple C-BNG nodes can be active nodes for one or more subscriber groups (redundancy sessions) that serve the subscribers and they can, at the same time, be standby nodes for other subscriber groups.

One node, which is paired for redundancy, can perform subscriber services for more than one redundancy session (subscriber group). The peer node, which is

identical to the first node, contains the same subscriber group (redundancy session) as a standby. And in the event of that first node goes down due to any outage, the standby node can take over subscriber service for this redundancy session.

RBFS Redundancy allows running a redundancy session actively on one node and back up the same redundancy session (subscriber group) on a different (standby) C-BNG node. In RBFS redundancy, in fact, there is no active node or standby node. It is active subscriber group and standby subscriber group. A C-BNG node can be active for a subscriber group and at the same time it can be a standby for a different subscriber group. You can park a maximum number of 64 redundancy sessions (either active or standby) on a C-BNG node.

### **RBFS Redundancy Architecture**

The following architectural diagram provides a high-level view of RBFS in redundancy mode. It shows two RBFS nodes, paired for redundancy, deployed in an active-standby node cluster, with their interfaces are connected with an RD TCP connection. These peer nodes use the RD TCP connection for sending 'keepalive' messages and data mirroring for subscriber state synchronization.

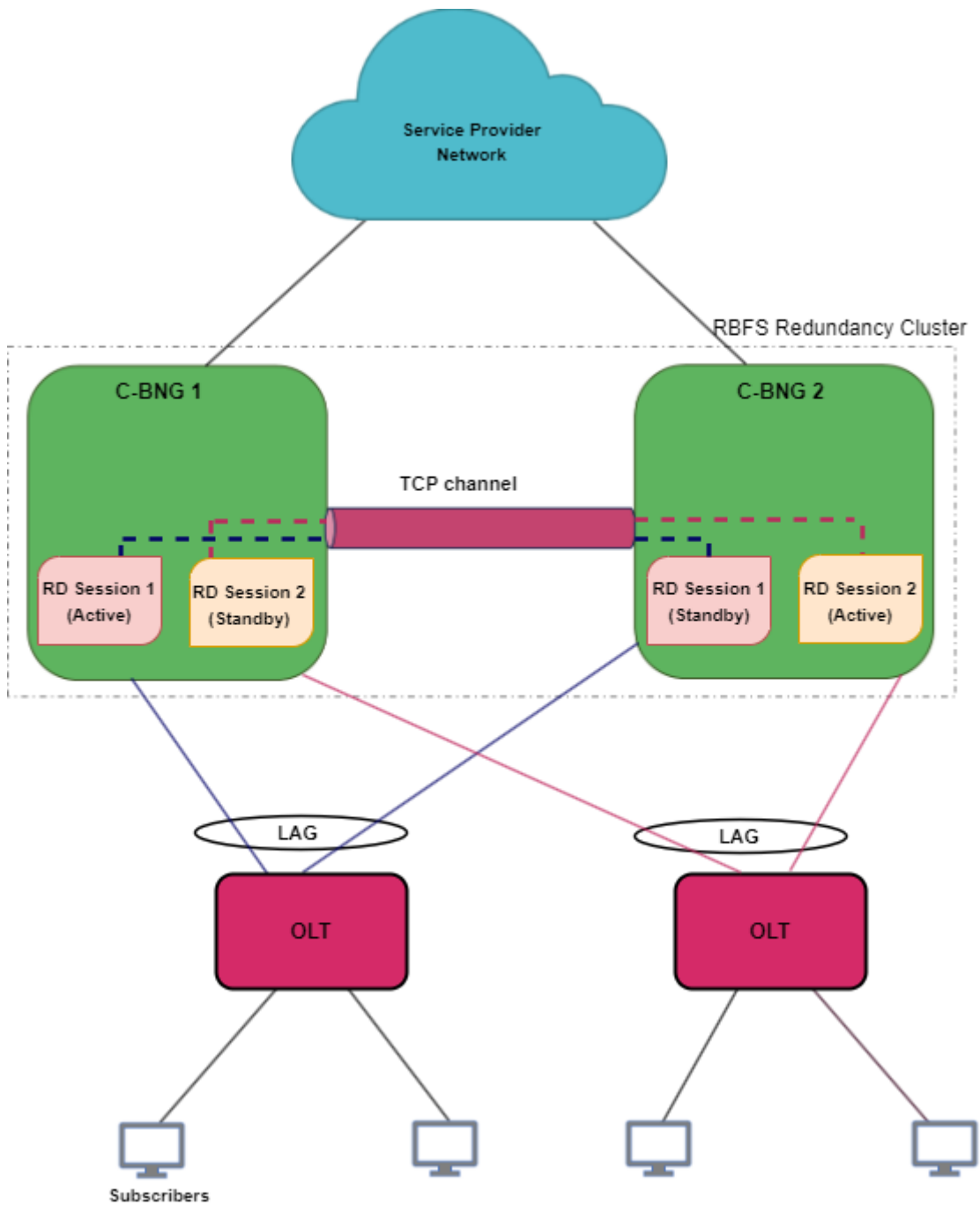

Both of the nodes are connected to an access device (OLT device in this scenario) on one end from where it receives subscriber traffic and sends traffic. The nodes are also connected to the core network on the other end.

The node 'C-BNG 1' is in active state and performs subscriber services for the 'Session 1' (redundancy subscriber group). 'Session 1' is also mirrored in the C-BNG 2 in standby mode. The standby device mirrors concurrent subscriber state data for 'Session 1' from the active peer. If an active node goes down due to any reason, the peer node detects the outage and uses mirrored 'Session 1' to perform subscriber services.

One C-BNG node acts as active node for one or more sessions (subscriber redundancy groups) and as a standby C-BNG for other subscriber redundancy groups at the same time. The following diagram illustrates the scenario.

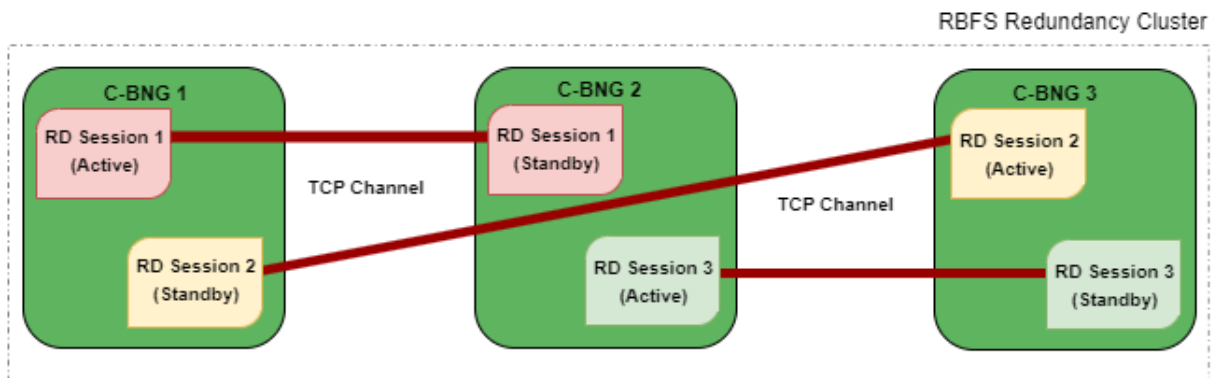

'Session 1' is active in C-BNG 1 and is in standby mode in C-BNG 2.  
 'Session 2' is active in C-BNG 3 and is in standby mode in C-BNG 1.  
 'Session 3' is active in C-BNG 2 and is standby mode in C-BNG 3.

RBFS Redundancy can mitigate the following types of failures:

- Link failure Between Active RBFS Node and Access Node (OLT, DSLAM or MSAN)
- Node Outage

### Redundancy for Node Outage

A node outage, which can bring down the subscriber services, can occur due to many reasons on a network. RBFS Redundancy helps to minimize the impact and reduce interruptions and downtime by providing a resilient system. In the event of a node outage, RBFS Redundancy triggers switchover in which the standby node takes over from the active node with very minimal impact on the subscriber services.

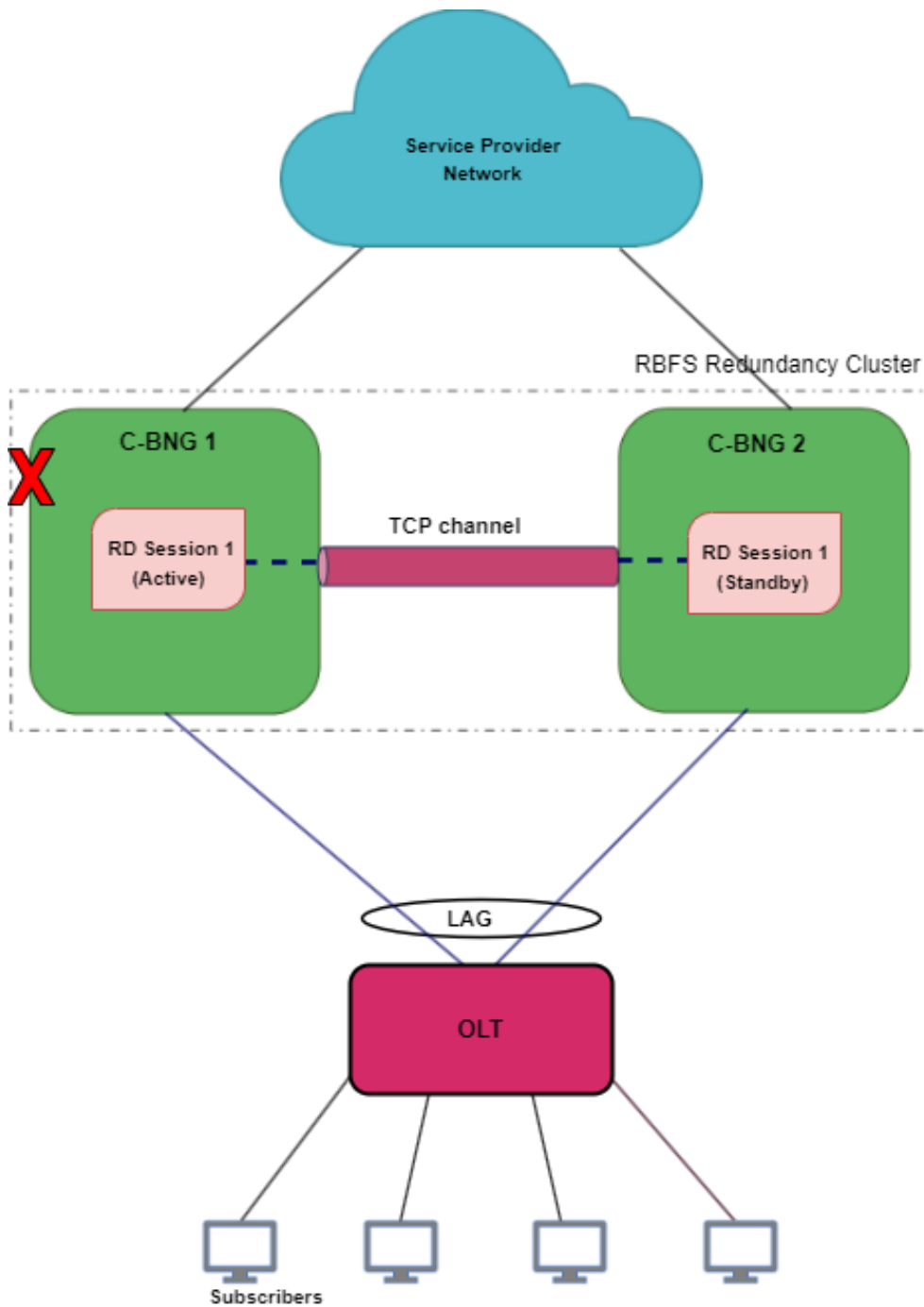

The diagram shows **cbng1** as an active node serving subscribers and **cbng2** stays as a standby. When an active node goes down, the standby node detects the same and takes over from the active RBFS node. In a node outage scenario, the node becomes unresponsive and cannot maintain communication with its peer node the RD TCP link.

### Redundancy for Link Failure

In RBFS Redundancy, Link Aggregation combines multiple physical links into a single logical link. If a member link, which is part of a LAG, goes down, the LAG



fails. The diagram shows the 'cbng1' and 'cbng2' deployed in redundancy mode and is connected to the access device with LAGs. When the LAG between 'cbng1' and the access node goes down, the 'cbng1', which is running 'Session 1', becomes inactive for the subscriber group. So the 'cbng2', which is the standby for 'Session 1', detects the failure of 'cbng1' and starts performing subscriber services for 'Session 1' by providing a quick recovery from the disruption.

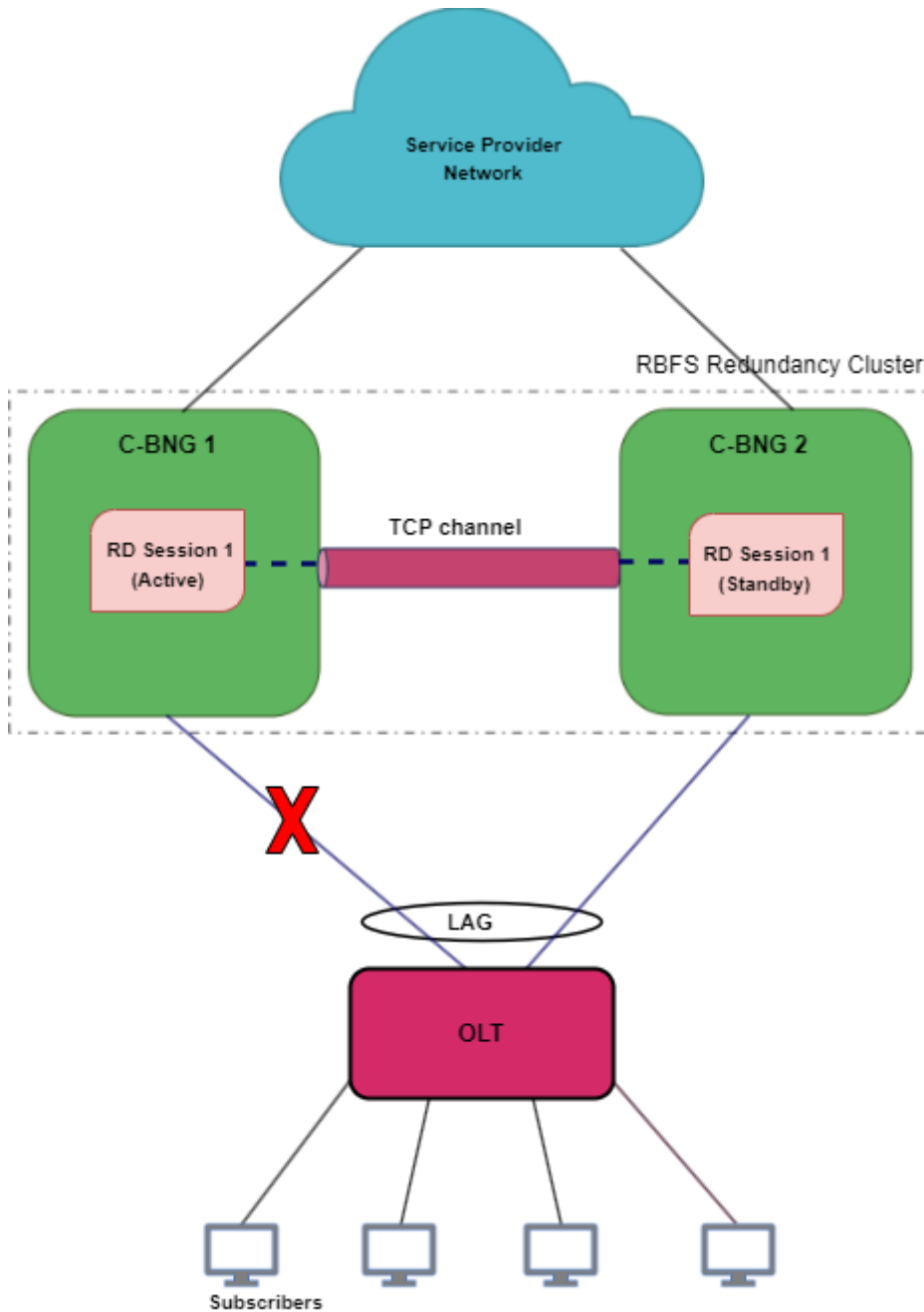

In this link or LAG failure scenario, **cbng1** is in a healthy state, only the LAG interface went down. It cannot perform subscriber services for the particular redundancy session. However, it can keep communication with its peer node as the RD TCP channel.

## Subscriber Data Synchronization

RBFS Redundancy subscriber data from the active node is always synced to the standby node. So that if the active node goes down, the standby node takes over and restores traffic forwarding which was previously performed by its peer node. It ensures that traffic can keep flowing even in the event of an outage.

## Node States in Redundancy

In RBFS redundancy, C-BNG nodes have different states for various redundancy sessions. Typically, RBFS redundancy nodes encounter the following states for redundancy sessions:

**Active:** All subscribers are served by active node in the RBFS active-standby node cluster. One node which is active for a redundancy session can be a standby node for a different session. Nodes, that are paired for redundancy, send 'keepalive' messages to each other and also synchronize all subscriber state data with the peer node. The priority values that you specify for the redundancy nodes determine the roles of active and standby. The node that receives the higher priority value for the session ID assumes the role of active for that subscriber group. To set one device as 'active', you must specify higher priority value for the redundancy session for that node.

**Standby:** Standby node is identical with the active node and synchronizes subscriber data concurrently from peer node. It keeps communication with the peer node to monitor node health status using 'keepalive' messages. The node that gets the lower priority value for the redundancy session ID assumes the role of standby. Standby node for a subscriber group does not perform any subscriber services for that group unless or until the active node encounters an outage.

**Down:** When a node becomes inactive due to an outage, it is considered as 'down'. In the event of a node outage, it is completely down and cannot perform subscriber services and any communication with its peer node. But in the case of a LAG (between the node and access node) failure, the node cannot perform subscriber services, but it can communicate with the peer node through the RD TCP connection. So that the subscriber state synchronization occurs without any interruption.

**Stand Alone:** When the active node goes down, the switchover occurs and standby takes over the subscriber service. In this scenario, the serving node is in 'stand alone' state (for that redundancy session) as it has no peer node for

redundancy.

## Revert or Rollback

In RBFS Redundancy, after a node or link failure and the subsequent switchover, the standby takes over and continues the subscriber service for that subscriber group even after the other node (previously active) recovers from the failure. There is no automated rollback or revert to the previously active router. However, administrators can perform a manual switchover.

## Monitoring Node Health Status

The RBFS nodes, which have switchover capacities, monitor each other for the health status. RBFS Redundancy uses 'keepalive' messages that check on the health of the RBFS nodes. Both of the devices send 'keepalive' messages to each other in every five seconds. One Node can detect a failure if it does not receive 'keepalive' messages for a period of 20 seconds from the other node.

## Redundancy Clients

There are multiple RBFS daemons that participate in providing redundancy. They include redundancy daemon, (`rd`), LAG daemon (`lagd`), interface daemon (`ifmd`), subscriber daemon (`subscriberd`), IPoE daemon (`ipoed`). These daemons, which perform various roles, are known as redundancy clients.

## Redundancy Daemon

Redundancy Daemon is responsible for establishing high-availability connections. It monitors the ecosystem and detects any outages that may happen on the network. It assigns the roles of active or standby to the nodes depending on the priority configured on the node. The daemon triggers a switchover to the standby node if a failure occurs. It responds to the failure events which are reported locally by daemons who are the redundancy clients. It also cleanses the data after switchover from the node that went down.

## Supported Hardware Platforms

Currently, RBFS can be deployed in redundancy mode using the RBFS C-BNG (Consolidated BNG) switches. RBFS C-BNG software provides complete BNG functionalities on a single compact hardware switch. You can use the following hardware platforms to deploy RBFS in redundancy mode.

- UfiSpace S9600-72XC: The UfiSpace S9600-72XC is a multi-function, disaggregated white box aggregation routing platform that is equipped with Broadcom's Qumran2c chipset. It features 64x25GE and 8x100GE high-speed ports with a switching capacity of up to 2.4Tbs.
- Edgecore AGR420: AGR420 is a high performance 25GbE aggregation router that consists of fixed 64 x 10G/25G SFP28, 8 x 100GE QSFP28 and 2 x 100G QSFP-DD network interface configurations.

## **RBFS Redundancy Requirements**

The following are the requirements for setting up RBFS Redundancy.

- Ensure that both of the platform devices, on which RBFS software runs, must be the same model.
- Ensure that the devices should run the same version of RBFS software. RBFS software 23.2.1 and later versions support deployment in redundancy mode.
- NTP must be configured on both devices to match the timestamps.

### **5.8.2. Deploy RBFS in Redundancy Mode**

#### **RBFS Redundancy**

This section provides information on how to deploy RBFS C-BNG device pair to achieve redundancy. The following workflow diagram depicts the end-to-end deployment of RBFS in Redundancy mode:

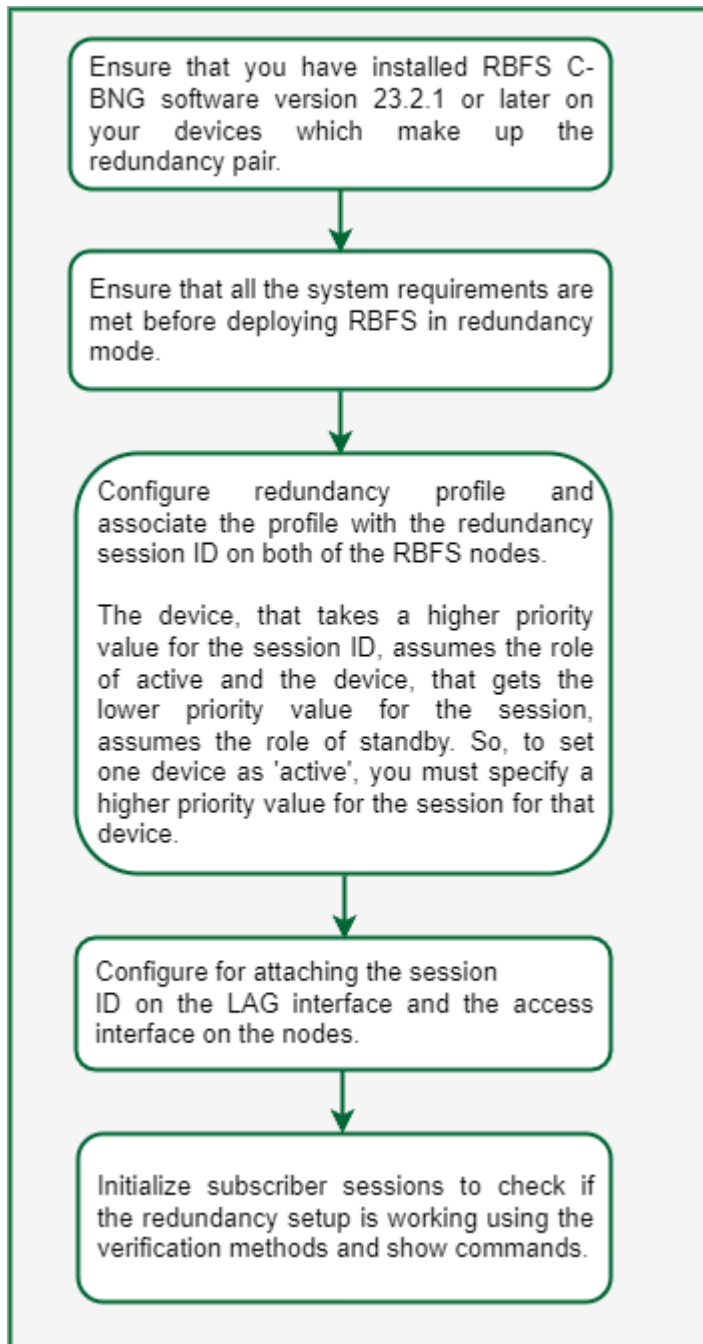

You must perform the following tasks to deploy the RBFS devices in redundancy mode. These configurations must be performed on both of the devices.

1. Configure Redundancy Profile
2. Configure Session for Redundancy
3. Configure Link Aggregation Group for Redundancy
4. Configure Access for Redundancy

## Configuration Syntax and Commands

The following sections describe syntax and commands for various configurations.

### Configuring Redundancy Profile

Redundancy profile configuration is used to provide peer identity in redundancy. While configuring the redundancy profile on the nodes, you must specify IP addresses of both the peer nodes. Based on the priority value that you specify for the session ID, the peers take the roles of active and standby for the Session.

#### Syntax:

**set redundancy profile** <name>

Attribute	Description
peer	Redundancy configuration
switchover-hold-timer	Minimum time interval between consecutive switchovers in seconds.

Run the following commands to configure redundancy profile.

```
set redundancy profile rd_ipoe
set redundancy profile rd_ipoe peer ipv4 remote-address 198.51.100.2
set redundancy profile rd_ipoe peer ipv4 update-source 198.51.100.1
set redundancy profile rd_ipoe peer ipv4 instance default
```

#### Example Configuration:

```
supervisor@rtbrick>cbngl.rtbrick.net: cfg> show config redundancy profile
{
  "rtbrick-config:profile": [
    {
      "name": "rd_ipoe",
      "peer": {
        "ipv4": {
          "remote-address": "198.51.100.2",
          "update-source": "198.51.100.1",
          "instance": "default"
        }
      }
    }
  ]
}
```

## Configuring Session for Redundancy

You can configure Redundancy Session with a unique session ID. You can define the system priority value (which determines active and standby roles) and the associate Redundancy profile configuration in the Redundancy Session configuration.

### Syntax:

**set redundancy session** <session-id>

Attribute	Description
keepalive-interval	Keepalive message transmission interval in seconds. Default is 5 seconds.
priority	Session priority
profile	Profile name

Run the following commands to configure session for redundancy.

```
set redundancy session 100
set redundancy session 100 priority 10
set redundancy session 100 profile rd_ipoe
```

### Configuration Example:

```
supervisor@rtbrick>cbng2.rtbrick.net: cfg> show config redundancy session
{
  "rtbrick-config:session": [
    {
      "session-id": 100,
      "priority": 10,
      "profile": "rd_ipoe"
    }
  ]
}
```

## Configuring LAG for Redundancy

You must associate the Redundancy Session with the LAG. While configuring LAG for redundancy, you must specify the session ID to associate the LAG with the Redundancy Session. LAG can identify its Redundancy Session with this mapping.

### Syntax:

## set link-aggregation interface <interface-name> options

Attribute	Description
description	Link aggregation interface description.
member-interface	Link aggregation member interface configuration
minimum-link-count	Minimum number of active member links required for the link aggregation interface. default values is 1.
mode	Mode of the link aggregation interface, static or lacp. default mode is lacp.
rd-role	Role of the link aggregation interface, active or standby.
rd-system-priority	The value for the system priority range from 1 to 65535. The lower the value, the higher the system priority. default value is 65535.
redundancy-session-id	The value for the redundancy group session id range from 1 to 65535.
system-id	Redundancy System ID of link-aggregation interface.

Run the following commands to configure LAG for redundancy.

```
set link-aggregation interface lag-1
set link-aggregation interface lag-1 mode lacp
set link-aggregation interface lag-1 minimum-link-count 1
set link-aggregation interface lag-1 redundancy-session-id 100
set link-aggregation interface lag-1 system-id a8:b5:7e:8f:66:43
set link-aggregation interface lag-1 member-interface ifp-0/1/260
```

Example Configuration:

```
supervisor@rtbrick>cbng2.rtbrick.net:: cfg> show config link-aggregation interface lag-1
{
  "rtbrick-config:interface": [
    {
      "interface-name": "lag-1",
      "mode": "lacp",
      "minimum-link-count": 1,
      "redundancy-session-id": 100,
      "system-id": "11:22:33:44:55:66",
      "member-interface": [
        {
          "member-interface-name": "ifp-0/0/4"
        }
      ]
    }
  ]
}
```



```

    ]
  }
]
}

```

## Configuring Access for Redundancy

IPoE and Redundancy Session mapping is essential to associate the Redundancy Session with IPoE. While configuring access for redundancy, you must specify access type as IPoE.

### Syntax:

**set access interface double-tagged** <name> <options>

Attribute	Description
aaa-profile-name	AAA profile name
access-profile-name	Access profile name
access-type	Access service type
gateway-ifl	IPoE gateway IFL (unnumbered source IFL)
max-subscribers-per-mac	Restrict maximum subscribers per MAC address
max-subscribers-per-vlan	Restrict maximum subscribers per VLAN
redundancy-session-id	Redundancy session id for this interface
service-profile-name	Service profile name
vlan-profile-enable	Enable VLAN profiles

Run the following commands access for redundancy.

```

set access interface double-tagged lag-1 1001 1100 1001 1100
set access interface double-tagged lag-1 1001 1100 1001 1100 access-type IPoE
set access interface double-tagged lag-1 1001 1100 1001 1100 access-profile-name
ipoe
set access interface double-tagged lag-1 1001 1100 1001 1100 aaa-profile-name
ipoe-aaa
set access interface double-tagged lag-1 1001 1100 1001 1100 gateway-ifl lo-
0/0/0/10
set access interface double-tagged lag-1 1001 1100 1001 1100 redundancy-session-id
100

```

Example Configuration:

```
supervisor@rtbrick>cbng1.rtbrick.net: cfg> show config access interface double-  
tagged lag-1  
{  
  "rtbrick-config:double-tagged": [  
    {  
      "interface-name": "lag-1",  
      "outer-vlan-min": 1001,  
      "outer-vlan-max": 1100,  
      "inner-vlan-min": 1001,  
      "inner-vlan-max": 1100,  
      "access-type": "IPoE",  
      "access-profile-name": "ipoe",  
      "aaa-profile-name": "ipoe-aaa",  
      "gateway-ifl": "lo-0/0/0/10",  
      "redundancy-session-id": 100  
    }  
  ]  
}
```

## Switchover Manually

Administrators can perform a manual switchover from an active node to a standby node. Use the following command to perform switchover:

```
switch-over session <session-id> confirm
```

## 5.8.3. RBFS Redundancy Operational Commands

### Redundancy Show Commands

With the RBFS Command Line Interface, you can view output of operational commands. The redundancy operational commands provide detailed information about the RBFS redundancy operations.

#### Client Statistics

##### Syntax:

**show redundancy client <name> statistics**

This command displays information from redundancy client (daemon) which is a participant in the redundancy sessions. The daemons **ifmd**, **ipoe1.1**, **lagd**, and **subscriberd.1** are the client daemons in redundancy sessions.

Command:

```
show redundancy client lagd statistics
```

### Example:

```
supervisor@rtbrick>ufi08.q2c.u23.r4.nbg.rtbrick.net: op> show redundancy client
lagd statistics
Session id: 100, Profile: rd_ipoe
  Agent State: down
  TCP operational state: down
  Message statistics:
    Keep alive sent: 0
    Keep alive received: 0
  Last 5 state changes: [Latest first]
    down                : 2022-12-08T08:47:06.077823+0000
    demote-ready        : 2022-12-08T08:47:06.077798+0000
    demote-infra-wait   : 2022-12-08T08:47:06.077769+0000
    demote-app-wait    : 2022-12-08T08:47:06.077713+0000
    active              : 2022-12-08T06:57:53.058172+0000
  Connection statistics:
    Peer Address: 198.51.100.2
    Application down notifications: 0
    Connection down notifications: 0
    Retry count: 0
    Session down received: 8
```

## Session Details

### Syntax:

### **show redundancy session detail**

The command displays RD session details.

### Command:

```
show redundancy session detail
```

### Example:

```
supervisor@rtbrick>ufi08.q2c.u23.r4.nbg.rtbrick.net: op> show redundancy session
detail
Redundancy session ID: 100, Update source: 198.51.100.1, Peer: 198.51.100.2.
  Instance: default, Profile name: rd_ipoe, Local priority: 20
  State: down, Previous state: active, Last state transition time: 2022-12-
08T08:47:06.071930+0000
  TCP operational state: down
  Message statistics:
    Keep alive sent: 21516
    Keep alive received: 21515
    Switch overs detected: 0
```

```
Timers:  
  Connect retry interval: 2000  
  keep alive timer interval: 3000  
  Holddown timer interval: 9000
```

## Session ID Details

### Syntax:

#### **show redundancy session <ID> detail**

The command displays RD session detail for a session ID. Command:

```
show redundancy session 100 detail
```

### Example:

```
supervisor@rtbrick>ufi08.q2c.u23.r4.nbg.rtbrick.net: op> show redundancy session  
100 detail  
Redundancy session ID: 100, Update source: 198.51.100.1, Peer: 198.51.100.2  
  Instance: default, Profile name: rd_ipoe, Local priority: 20  
  State: down, Previous state: active, Last state transition time: 2022-12-  
08T08:47:06.071930+0000  
  TCP operational state: down  
  Message statistics:  
    Keep alive sent: 21516  
    Keep alive received: 21515  
    Switch overs detected: 0  
  Timers:  
    Connect retry interval: 2000  
    keep alive timer interval: 3000  
    Holddown timer interval: 9000
```

## Session ID Status

### Syntax:

#### **show redundancy session <ID> status**

The command displays status information of a session ID.

Command:

```
show redundancy session* <ID> *status
```

### Example:

```

supervisor@rtbrick>ufi08.q2c.u23.r4.nbg.rtbrick.net: op> show redundancy session
100 status
State: down, Remote State: invalid
Redundancy client replication information:
  Total redundancy clients : 5
  ifmd:
  ipoed.1:
  lagd:
  poold:
  subscriberd.1:
    Number of subscribed table: 1

```

## Session History

### Syntax:

#### **show redundancy session <ID> status**

The command displays history of a session ID for a specified count.

```
show redundancy session 100 history count 3
```

```

supervisor@C2-STD-27-2804>bm04-tst.fsn.rtbrick.net: cfg> show redundancy session
100 history count 3
Previous state      Current state      State change reason  Timestamp
connect           standby           standby              2022-12-
21T07:05:36.010847+0000
down              connect           open                 2022-12-
21T07:05:29.738121+0000
invalid           down              init                 2022-12-
21T07:00:44.282300+0000

```

# 6. Forwarding

## 6.1. Interfaces

### 6.1.1. Interfaces Overview

RtBrick Full Stack (RBFS) supports various types of interfaces, including physical and logical interfaces. On hardware platforms, RBFS physical interfaces represent the ports of a switch. This guide describes how to configure and verify RBFS interfaces. Features like routing protocols or access services will typically run on top of the interfaces.

### Interface Types

#### Physical Interfaces

In RBFS, physical interfaces (IFP) typically represent the physical ports of a hardware switch. For example, `ifp-0/0/1` represents switch port 1. On the physical interface level, you can configure various parameters associated with Layer 1 of the ISO/OSI reference model.

#### Logical Interfaces

For each physical interface, you can create one or multiple interface units also referred to as logical interfaces (IFL) in RBFS. A logical interface is associated with the Layer 2 operation. In addition, you can configure Layer 3 parameters like IP addresses on interface units, and assign interface units to routing instances.

#### Loopback Interfaces

A loopback interface is typically used to represent and identify a device itself. Loopback interfaces are preferred because they do not depend on the status of a physical port, and will always be up. Please note, although loopback interfaces are virtual interfaces, there are also represented as physical interfaces and interface units in RBFS, reflecting Layer 1 and Layer 2/3 operation.

#### Host Interfaces

Linux virtual ethernet (veth) interfaces connect an LXC container with the Linux host OS. In RBFS, a veth interface to the Linux bridge `lxcbr0` is created by default. In virtual topologies, you can create additional veth interfaces and

Linux bridges. RBFS host interfaces represent veth interfaces in RBFS.

For example, if the container interface eth1 connects to the host interface vethXYZ123, ifp-0/0/1 can be bound to eth1 to represent it in RBFS. Host interfaces can be used like any other physical interface.

## Memory Interfaces

Memory interfaces (memif) are virtual interfaces used for creating virtual topologies. They connect multiple containers running RBFS to each other. When configuring memif interfaces:

- Endpoints match on the memif ID, i.e. the memif ID needs to be the same on both ends.
- memif IDs need to be unique on the host.
- The memif interface name is locally significant only.
- One endpoint needs to be configured as a master, while the other one is configured as a slave.

## Interface Numbering

RBFS interface numbers match the port numbers on the switch faceplate. An interface is named in the ifp-`<chassis-ID>/<front-panel-block-number>/<port>` format. For example, ifp-0/0/1.

- Chassis ID—always 0 for the currently supported platforms
- Front Panel Block—represents group of ports on the faceplate
- Port—matches the port number on switch faceplate

Virtual interfaces follow the same structure, for example, `lo-0/0/1` or `memif-0/0/1`.

Logical interfaces are numbered: `ifl-<Node ID>/<Chip ID>/<Port ID>/<Unit ID>`, for example `ifl-0/0/1/1`.

## Community Support for Interfaces

You can tag an interface address with a community or extended community. RBFS will create a direct route for each interface address. If a community or extended community is configured for an interface address, RBFS will add it to the direct route. Communities can be used in policies. For example, when redistributing

direct routes, you can match these communities and define desired policy rules.

## Unnumbered Interfaces

An unnumbered interface is a point-to-point interface that is not explicitly configured with a dedicated IP address and subnet. Instead, it borrows (or links to) from a loopback interface, and uses it as the source IP address for packets originating from the interface. The IP unnumbered interface can "borrow" the IP address from another interface that is already configured on the switch, thereby conserving network and address space.

The IP address of the unnumbered interface cannot be borrowed as it has no dedicated IP address. A logical interface can borrow IP address from a loopback interface, not vice versa.

## Auto-negotiation

Auto-negotiation allows directly connected devices to automatically exchange speed and duplex mode information for the links. If auto-negotiation is enabled, ports can auto-negotiate the speed and duplex capabilities with other ports. The auto-negotiation can determine the best speed and duplex at which the ports can operate optimally.



Port speed configuration and auto-negotiation are mutually exclusive.

RBFS supports auto-negotiation between ports in the following ways:

- 1G ports can negotiate with 10G ports.
- 40G ports can negotiate with 100G ports.

Auto-negotiation is not supported for the following combinations:

- 40G ports cannot negotiate with 1G ports, 10G ports, and 25G ports.
- 100G ports cannot negotiate with 1G ports, 10G ports and 25G ports.
- 1G port cannot negotiate with 25G port.

## Interface Counters

Interface counters are statistics that network devices maintain for the traffic



passing through the interfaces for all physical, logical, and LAG interfaces on a device. These counters provide information about the utilization and performance of the interface. Users can identify and troubleshoot issues such as congestion, errors, and performance bottlenecks by monitoring these counters.

### RBFS Logical Interface counters and descriptions

Counters	Descriptions
Rx packets	The number of IP packets received by the logical interface.
Rx bytes	The number of bytes received by the logical interface.
Tx packets	The number of packets transmitted by the logical interface.
Tx bytes	The number of bytes transmitted by a logical interface.
IPv4 packets	The number of IPv4 packets processed by a logical interface.
IPv6 packets	The number of IPv6 packets processed by a logical interface.
MPLS packets	The number of MPLS packets processed by a logical interface.
Punt packets	The number of packets that are punted or forwarded to the CPU for further processing by a logical interface.
Drops packets	The number of packets that were dropped by a logical interface.
Rx Miss packets	The number of packets that were dropped by a logical interface.
Rx Error packets	The number of packets that were received with errors by the logical interface.
Rx No Buff packets	The number of packets that could not be received due to a lack of buffer space. When a logical interface receives a packet but does not have enough buffer space to store it, the packet is dropped.

<b>Counters</b>	<b>Descriptions</b>
Tx Error packets	The number of packets that could not be transmitted due to errors encountered during the transmission process.
<b>Packet Statistics</b>	
Ingress forwarded packets	The number of packets that are received by the device on one interface and then forwarded out on another interface.
Ingress forwarded bytes	The number of bytes that are received by a device on one interface and then forwarded out on another interface.
Ingress drop Packets	The number of packets that are dropped (discarded) by a network device upon arrival on one of its interfaces by a device.
Ingress drop bytes	Total number of bytes that have been dropped by an interface on incoming traffic.
Egress forwarded packets	Total number of packets that have been successfully forwarded by an interface on outgoing traffic.
Egress forwarded bytes	The number of bytes that have been forwarded by an interface in the egress direction.
Egress drop packets	The number of packets that have been dropped by an interface in the egress (outgoing) direction.
Egress drop bytes	The number of bytes that have been dropped by an interface in the egress direction.

### **RBFS physical interface counters and descriptions**

<b>Physical Interface Counters</b>	<b>Descriptions</b>
<b>VPP Statistics</b>	
Rx packets	The number of IP packets received by the physical interface.
Rx bytes	The number of bytes received by the physical interface.

<b>Physical Interface Counters</b>	<b>Descriptions</b>
Tx packets	The number of packets transmitted by the physical interface.
Tx bytes	The number of bytes transmitted by the physical interface.
IPv4 packets	The number of IPv4 packets processed by the physical interface.
IPv6 packets	The number of IPv6 packets processed by the physical interface.
MPLS packets	The number of MPLS packets processed by a physical interface.
Punt packets	The number of packets that are punted or forwarded to the CPU for further processing by a physical interface.
Drops packets	The number of packets that were dropped by a physical interface.
Rx Miss packets	The number of packets that were dropped by a physical interface.
Rx Error packets	The number of packets that were received with errors by the physical interface.
Rx No Buff packets	The number of packets that could not be received due to a lack of buffer space. When a physical interface receives a packet but does not have enough buffer space to store it, the packet is dropped.
Tx Error packets	The number of packets that were dropped by a physical interface.
<b>BCM Statistics</b>	
inOctets	Number of octets received through the interface.
inUcastPkts	Number of unicast packets received through the interface.
inNonUcastPkts	Number of non-unicast packets received through the interface.

<b>Physical Interface Counters</b>	<b>Descriptions</b>
inErrors	The number of inbound packets that contained errors preventing them from being processed correctly.
outOctets	Number of octets sent through the interface.
ifHCInOctets	The number of octets (8-bit bytes) received by a network interface. It is a part of the SNMP MIB (Management Information Base) structure and is used to track high-capacity input octets counter used in the context of SNMP monitoring.
outUcastPkts	Number of unicast packets sent through the interface.
outNonUcastPkts	Number of non-unicast packets sent through the interface.
outErrors	The number of outbound packets that contained errors preventing them from being processed correctly.
etherStatsDropEvents	Number of events where packets were not delivered to the protocol stack because of resource limitations or other reasons. These dropped events can occur due to buffer overflows, congestion, or hardware limitations.
etherStatsMulticastPkts	The number of packets received by an interface that were addressed to a multicast MAC address.
etherStatsBroadcastPkts	The number of broadcast packets received on an Ethernet interface.
etherStatsUndersizePkts	The number of received packets that are smaller than the minimum allowed Ethernet frame size. Undersized packets can indicate various issues.
etherStatsFragments	The number of received packets that are fragments of IP datagrams.
etherStatsOversizePkts	The number of received packets that exceed the maximum Ethernet frame size.

<b>Physical Interface Counters</b>	<b>Descriptions</b>
etherStatsOctets	The total number of octets (bytes) of data transmitted and received on an Ethernet interface. This counter provides a measure of the total amount of data traffic on the interface.
etherStatsPkts	The number of packets transmitted or received by an Ethernet interface. This counter can provide insights into the traffic load and performance of the interface.
dot1dBasePortMtuExceededDiscards	The number of frames that were discarded at an interface as they exceeded the Maximum Transmission Unit (MTU) of the port. This typically happens when a frame is larger than the maximum size allowed on the interface and cannot be fragmented, so it is dropped.
etherStatsTXNoErrors	The number of Ethernet frames transmitted without any errors through the Ethernet interface. Each time a frame is successfully transmitted without encountering any errors, this counter is incremented.
etherStatsRXNoErrors	The number of Ethernet frames received without any errors through the Ethernet interface. Each time a frame is successfully transmitted without encountering any errors, this counter is incremented.
inMulticastPkts	The number of packets received by the interface that were addressed to a multicast address. These counters provide insights into the amount of multicast traffic being received by the interface.
outBroadcastPkts	The number of packets transmitted by the network interface as broadcast packets. These counters can provide insights into the amount of broadcast traffic generated by the interface.
outMulticastPkts	The number of packets transmitted by the interface as multicast packets. These counters can provide insights into the amount of multicast traffic generated by the interface.

<b>Physical Interface Counters</b>	<b>Descriptions</b>
outBroadcastPkts	The number of packets transmitted by the interface as broadcast packets. These counters can provide insights into the amount of broadcast traffic generated by the interface, which can be useful for network troubleshooting and monitoring network performance.
bcmReceivedUndersizePkts	The number of undersized packets received by a Broadcom device. Undersized packets are Ethernet frames that are smaller than the minimum allowed size. This counter provides insights into packet size issues.
bcmTransmittedUndersizePkts	The number of undersized packets sent by a Broadcom device. Undersized packets are Ethernet frames that are smaller than the minimum allowed size. This counter provides insights into packet size issues.
etherTxOversizePkts	The number of packets that exceed the maximum transmission unit (MTU) size allowed on an Ethernet interface.
etherStatsJabbers	The number of jabber frames received by an Ethernet interface. Jabber frames are Ethernet frames that exceed the maximum allowed frame size and contain data that extends beyond the maximum length.
etherStatsCRCAAlignErrors	<p>The number of frames received by an Ethernet interface that has a CRC (Cyclic Redundancy Check) error. Also, the frames are not an integral number of octets in length; that is, the frame length is not a multiple of 8 bits.</p> <p>CRC errors occur when the CRC checksum calculated by the receiving interface does not match the CRC checksum transmitted by the sending interface, indicating that the frame may have been corrupted during transmission</p>

<b>Physical Interface Counters</b>	<b>Descriptions</b>
dot3StatsFCSErrors	The number of frames that have a Frame Check Sequence (FCS) error received by an Ethernet interface. The FCS is a field in the Ethernet frame that contains a checksum calculated based on the contents of the frame.
ifHCOutMulticastPkts	The number of outbound multicast packets on a network interface. The ifHCOutMulticastPkts object uses a 64-bit counter, allowing it to accommodate high-speed interfaces without wrapping around as quickly. It provides an accurate count of the outbound multicast packets on the interface.
ifHCOutBroadcastPkts	The ifHCOutBroadcastPkts counter provides the number of outbound broadcast packets on an interface. It is part of the IF-MIB (Interface MIB) and is an extension of the standard ifOutBroadcastPkts counter, providing a 64-bit counter for high-speed interfaces to avoid wrapping around quickly.

## Path MTU Discovery

The Path MTU Discovery technique determines the maximum transmission unit between two hosts so that IP fragmentation can be avoided. By default, path MTU discovery is enabled in RBFS.

When RBFS receives MTU-violated packets, it will respond with the following ICMP error message:

### ICMPv4 Message Types

The type field identifies the type of the message sent by the host. The type field contains more specific information about the error condition.

The table below lists the ICMPv4 message types.

Type	Description
3	Destination Unreachable. This alerts a source host of delivery problems encountered while trying to reach the destination.

Destination Unreachable uses the following code values to further describe the function of the ICMP message being sent.

Code	Description
4	Fragmentation Needed and Don't-Fragment (DF) was Set. This message occurs when a router receives a packet that requires fragmentation, but the router has the DF DF flag turned on.

### ICMPv6 Message Types

The type field identifies the type of the message sent by the host. The type field contains more specific information about the error condition.

The table below lists the ICMPv6 message type.

Type	Description
2	Packet Too Big. A Packet Too Big MUST be sent by a router in response to a packet that it cannot forward because the packet is larger than the MTU of the outgoing link.

Code	Description
0	No code

You can change this behavior by enabling fragmentation. For more information about enabling hostpath fragmentation, see the section "Enabling Hostpath Fragmentation" below.

All outgoing packets are validated against the configured MTU on the egress path.

- If MTU is violated and MTU-profile action is **drop**, then packets are dropped in hardware.



- If MTU is violated and MTU-profile action is **redirect-to-cpu**, a 20MB policer is used to protect the CPU-port from overwhelming MTU-violated traffic, and packets are sent to the CPU port.
- When fragmentation is enabled, one of the following operations takes place.
  - If the DF bit is not set in the received packet (only for IPv4), the packets are fragmented and sent to the outgoing port.
  - If the DF bit is set in a packet, it drops the packet and sends an ICMP error message back to the source.
- When fragmentation is disabled, packets are dropped and ICMP error messages are sent to the source.

For information about configuring the MTU profile, see [<xref:interfaces\\_config.adoc#mtu-profile-config>](#).

## IP Fragmentation

If the length of the original IP packet is greater than the maximum transmission unit (MTU) of an outgoing interface, then the packet needs to be fragmented.

RBFS supports IP fragmentation on its Q2C platforms. MTU Profile configuration determines whether MTU-violated packets are dropped or punted to CPU. The forwarding-options configuration provides a knob to enable hostpath fragmentation for the packets punted to the CPU. If this configuration is not present, then the device sends an ICMP error to the source.

### Guidelines and Limitations of IP Fragmentation

The following guidelines and limitations apply to IP Fragmentation:

- If a packet is larger than the negotiated subscriber MTU size, it will be dropped or fragmented based on the configured MTU profile (on the Q2C platform). The Q2A platform does not support host-path fragmentation; only ICMP error can be returned. For details about MTU profile configuration, see "MTU Profile Configuration". You can control the fragmentation on the Q2C platform by configuring the **set forwarding-options fragmentation ipv4 state CPU** command. For more information about configuring fragmentation, see [Enabling Hostpath Fragmentation](#).
- The fragmented packets are sent over the regular QoS path in the egress

pipeline through reinjection.

- There will be no ICMP error message sent in response to MTU-violated multicast packets.

## MTU Profile

The Maximum Transmission Unit (MTU) is the size of the packet that is allowed in the network. In the new generation silicon like Broadcom Qumran2C (Q2C), resources are conserved by creating profiles of the resources, and multiple entities like IFP, IFL and L3 interfaces utilize these profiles. To better manage MTU resources and platform capabilities, RBFS supports configuring MTU profiles and attaching these profiles to the attachment points.

### Attachment Points

The MTU profiles are attached to the interface entities like physical (IFP), logical (IFL) and L3 interfaces. RBFS supports the below attachment points for MTU profiles:

- Port-level
- L3 interface level (IPv4 and IPv6)
- PPPoE subscriber level (L2 IFL)
- IPoE subscriber level

### MTU Size

A user-configured MTU size can range from 64 to 9216 in RBFS.



For MTU profiles of type "pppoe", users should provide L3 MTU size (IPv4/IPv6 headers).

### MTU Type

An MTU type specifies the attachment point of the MTU profile. The MTU types supported are as follows:

- **physical**: When checking MTU, the entire packet size is considered.
- **ipv4**: MTU check is based on IPv4 headers.
- **ipv6**: MTU check is based on IPv6 headers.
- **ip**: MTU profile of type IP and IPoE.

- **pppoe:** The MTU profile is applied to the PPPoE subscriber interface and the user is required to provide the L3 MTU size. Based on its best match algorithm, the Subscriber Management service associates these profiles with PPPoE subscribers.



- MTU profiles for L3 logical interfaces must be explicitly configured, and if not configured, no default MTU size is set for IPv4 and IPv6.
- On the Q2C platform, L3 interfaces can only be configured with IPv4 MTU profile or IPv6 MTU profile, but not both. However, with the type "ip" MTU profile, you can configure MTU for both IPv4 and IPv6 traffic with a common MTU size.
- On the QAX platform, only physical MTU profiles are supported.

### MTU Action

The MTU action defines the action to be taken when the MTU check fails. Currently, RBFS supports “drop” as an action.

### MTU Profile Limitations

The following limitations apply to the MTU profile:

- There is a limit to how many MTUs can be used by each hardware.

On the Q2C platform, the limit is as follows:

Maximum number of MTU profiles: 8

Maximum number of L3 MTU profiles: 3 (MTU type: IP/IPv4/IPv6)

Maximum number of PPPoE MTU profiles: 6 (including the default PPPoE profile)

Maximum number of physical MTU profiles: 7

On the QAX platform, the limit is as follows:

Maximum number of physical MTU profiles: 1

### Interface Holddown

## Overview

Interface Holddown or Interface Dampening is a delay mechanism to prevent network instability from flapping interfaces. Interface flapping occurs when an interface goes up and down repeatedly, leading to excessive route recalculations and needless notifications to other software components.

The Interface Holddown feature is used to prevent network instability by temporarily damping the interface state if it is fluctuating. This mechanism suppresses frequently fluctuating routes and ensures that only stable routes are advertised. It improves overall network performance by effectively utilizing resources such as memory and processing power.

## Option to Disable

By default, the Interface Holddown feature is enabled on RBFS. You can configure the 'hold-down down delay' and 'hold-down up delay' parameter values using the configuration commands. You can also disable the feature using the command.

## Benefits of Interface Holddown

Frequent updates due to route flaps can consume significant processing capacity. This can increase the CPU load on routers, and the constant route advertisements and withdrawals can consume bandwidth. The Interface Holddown mechanism minimizes unnecessary route recalculations and notifications, and the number of updates that need to be processed by suppressing frequently flapping routes. Suppressing unstable routes can improve overall network performance by ensuring that only stable routes are advertised and used for forwarding traffic.

## How RBFS Interface Holddown Works

When an interface flaps, such as an interface goes up and down frequently, RBFS employs a holddown period during which the interface's status is retained in its previous state.

The holddown time for an interface increases exponentially within a defined range. The values can be configured explicitly for each interface. When an interface flap occurs, the interface management daemon receives this event from the hardware through the FIBD.

The following diagram shows the interface holddown feature.

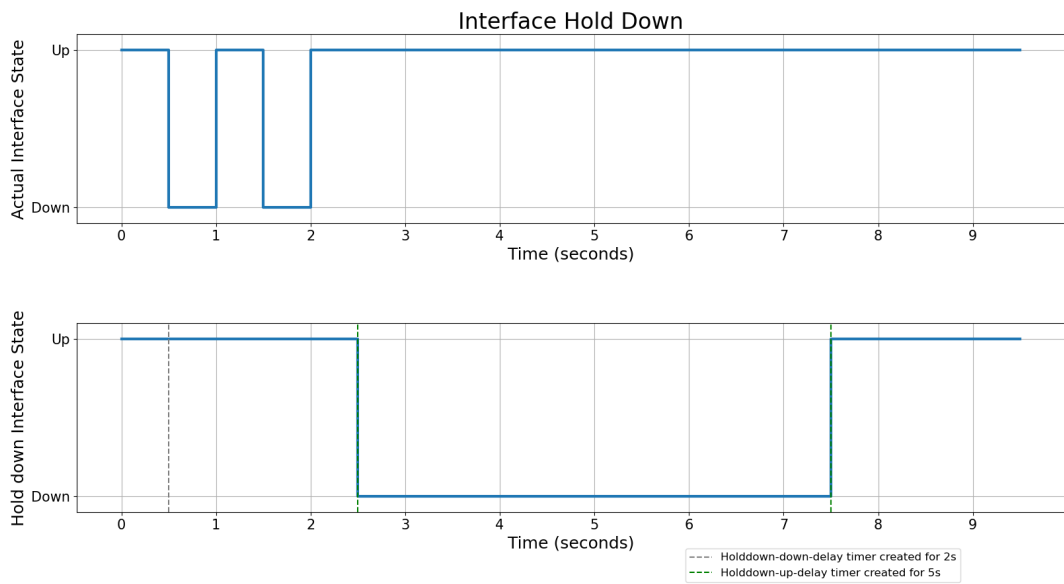

The holddown intervals are set at 0ms, 100ms, 200ms, 500ms, 1s, 2s, 5s, and 10s. When the holddown timer expires, the interface state is propagated to higher layers. If the interface remains stable throughout the holddown interval, the actual state is propagated. However, if the interface experiences instability during this interval, it remains in the DOWN state.

RBFS implements "Holddown Down Delay" and "Holddown Up Delay", two parameters that control how the interface flap is managed.

### Holddown Down Delay

The 'Hold-down Down Delay' parameter, once configured, ensures that the interface state change from UP to DOWN is delayed by the specified 'holddown down delay' period. After this delay, the default holddown mechanism takes over. Specifically:

1. The 'holddown' interval starts with its initial value, that is 'holddown down delay' period, and increments exponentially when each timer expires.
2. DOWN to UP state changes are delayed based on exponentially increasing intervals.

The following diagram shows 'holddown down delay' scenario.

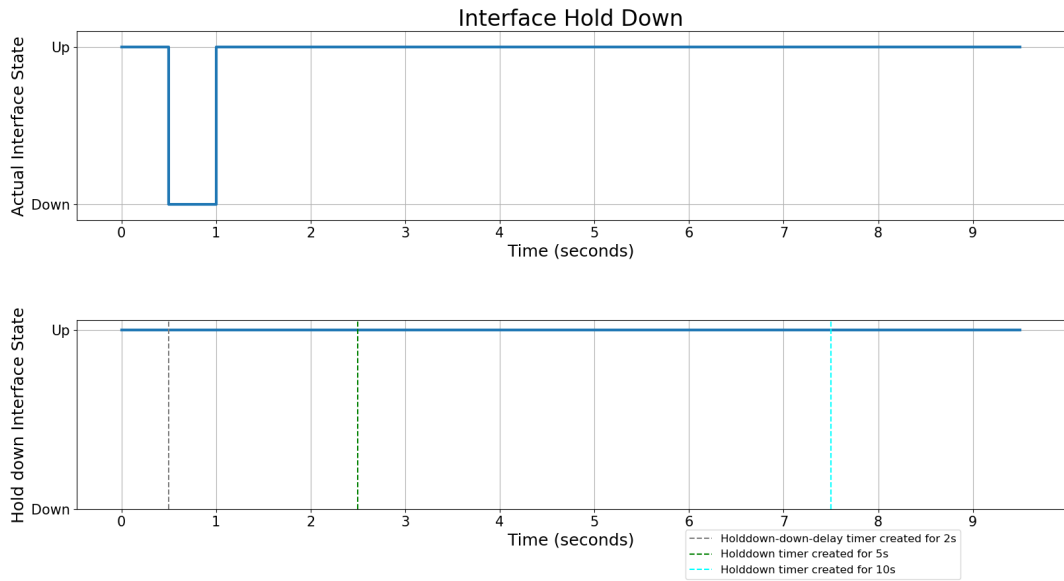

For example, if the 'holddown down delay' is set to 5 seconds and the interface state changes from UP to DOWN, the interface remains up for 5 seconds. After this 5-second delay, the system checks the stability of the interface:

- If the interface has no flap during this period, it remains up.
- If the interface has flapped during this period, it changes to the DOWN state after the delay.

In summary, Holddown Down Delay ensures an interface remains up for a specified time before propagating any state change to higher-level software components.

### Holddown Up Delay

'Holddown Up Delay' is the period that an interface stays down after a failure before it is considered to be in a stable state. When the state changes from DOWN to UP, a holddown timer is initiated with a specified delay period. If there are flaps during the previous interval time, then a new timer with the same 'holddown up' delay is set.

This results in a delay in the state transitioning to UP based on the 'holddown up delay'. However, if state changes happen within the 'holddown up delay' interval, any change from UP to DOWN is immediately transmitted. It uses a static timer instead of an exponential backoff for the holddown interval.

The following diagram shows 'holddown up' scenario.

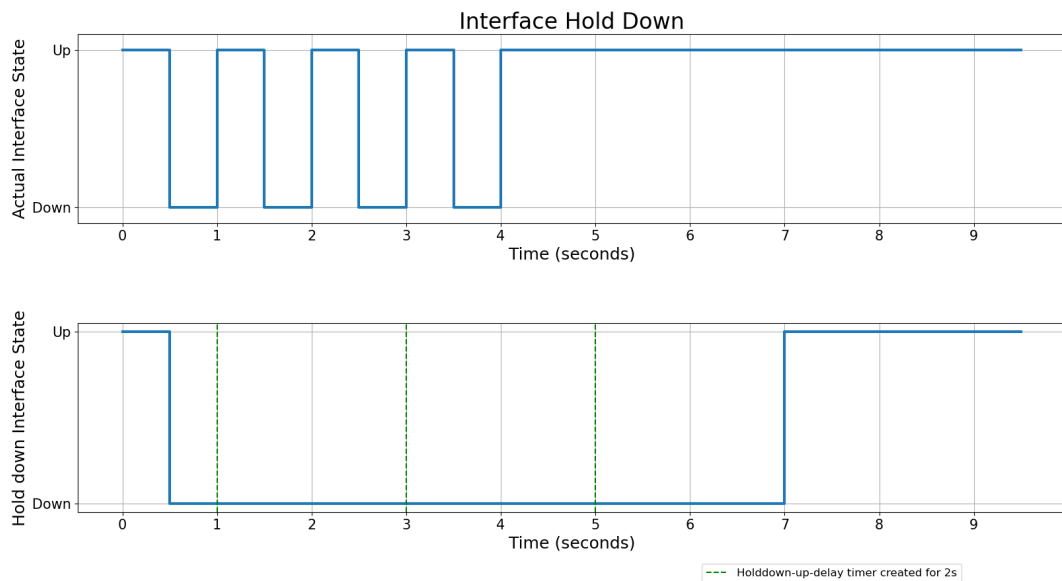

### Example Scenario

Imagine where a router's interface occasionally loses and regains connectivity due to a loose cable. Each time this happens, it creates an event that propagates through many of the software components in the network.

Without the Interface Holddown feature, every time disruption immediately triggers network protocols and higher-level software components to respond, potentially causing routing updates, recalculations, and additional processing overhead. This constant back and forth leads to network instability and adds additional strain on network devices.

With the interface Holddown enabled, the RBFS still receives these flap events but employs a hold-down mechanism to delay taking action on these changes. For example, with the holddown intervals: 0ms, 100ms, 200ms, 500ms, 1s, 2s, 5s, and 10s, the system performs the following:

- Retain the old interface status when an interface flap is detected.
- Wait for the initial hold-down time, which is 100ms.
- If another transition occurs within this period, the hold-down time increases to the next interval that is, 200ms. This process repeats, increasing the hold-down time after each transition up to the configured maximum value, which is 10s.

In this way, by delaying the processing of interface flaps, interface dampening reduces the impact of flapping on the network. The system only updates the

interface status after a stable period without transitions, thus preventing frequent, unnecessary updates.

## Guidelines & Limitations

### QAX-based Platforms

An additional restriction applies to ports on QAX-based platforms: because of hardware design, physical ports are grouped into quads (groups of 4, also known as port groups). Each quad must have the same physical parameters: speed, link-training, duplex.

The following tables are provided for easy identification of ports that need to have the same physical settings:

#### Edgecore 7316-26XB Port Groups:

Port	Speed	Duplex	Port Group
ifp-0/0/0	100G	Full	0
ifp-0/0/1	100G	Full	1
ifp-0/1/0	10G	Full	2
ifp-0/1/1	10G	Full	
ifp-0/1/2	10G	Full	
ifp-0/1/3	10G	Full	
ifp-0/1/4	10G	Full	3
ifp-0/1/5	10G	Full	
ifp-0/1/6	10G	Full	
ifp-0/1/7	10G	Full	
ifp-0/1/8	10G	Full	4
ifp-0/1/9	10G	Full	
ifp-0/1/10	10G	Full	
ifp-0/1/11	10G	Full	



<b>Port</b>	<b>Speed</b>	<b>Duplex</b>	<b>Port Group</b>
ifp-0/1/12	10G	Full	5
ifp-0/1/13	10G	Full	
ifp-0/1/14	10G	Full	
ifp-0/1/15	10G	Full	
ifp-0/1/16	25G	Full	6
ifp-0/1/17	25G	Full	
ifp-0/1/18	25G	Full	
ifp-0/1/19	25G	Full	
ifp-0/1/20	25G	Full	7
ifp-0/1/21	25G	Full	
ifp-0/1/22	25G	Full	
ifp-0/1/23	25G	Full	

### UfiSpace S9500-22XST Port Groups:

<b>Port</b>	<b>Speed</b>	<b>Duplex</b>	<b>Port Group</b>
ifp-0/0/0	10G	Full	8
ifp-0/0/1	10G	Full	
ifp-0/0/2	10G	Full	
ifp-0/0/3	10G	Full	
ifp-0/0/4	10G	Full	4
ifp-0/0/5	10G	Full	
ifp-0/0/6	10G	Full	
ifp-0/0/7	10G	Full	
ifp-0/0/8	10G	Full	11
ifp-0/0/9	10G	Full	
ifp-0/0/10	10G	Full	
ifp-0/0/11	10G	Full	

Port	Speed	Duplex	Port Group
ifp-0/0/12	25G	Full	3
ifp-0/0/13	25G	Full	
ifp-0/0/14	25G	Full	
ifp-0/0/15	25G	Full	
ifp-0/0/16	25G	Full	2
ifp-0/0/17	25G	Full	
ifp-0/0/18	25G	Full	
ifp-0/0/19	25G	Full	
ifp-0/0/20	100G	Full	0
ifp-0/0/21	100G	Full	1

A PHY Quad can be associated with network interface (NIF) ports of identical type only. For example, a quad cannot be a mix of XLGE and XE ports. An exception is GE and XE ports which can coexist in the same quad. This means all the ports in a port group should have the same physical interface configuration (that is, speed/duplex/link-training). Ports in a port group are only allowed to support 1G and 10G speeds; any other combination is not allowed. If a port within a port group is misconfigured, then it would require changing the speeds/interface type of all ports within the port group to a different type and then back into the original type.

## Supported Platforms

Not all features are necessarily supported on each hardware platform. Refer to the [Platform Guide](#) for the features and the sub-features that are or are not supported by each platform.

## 6.1.2. Interfaces Configuration

### Configuration Hierarchy

The diagram illustrates the interface configuration hierarchy.

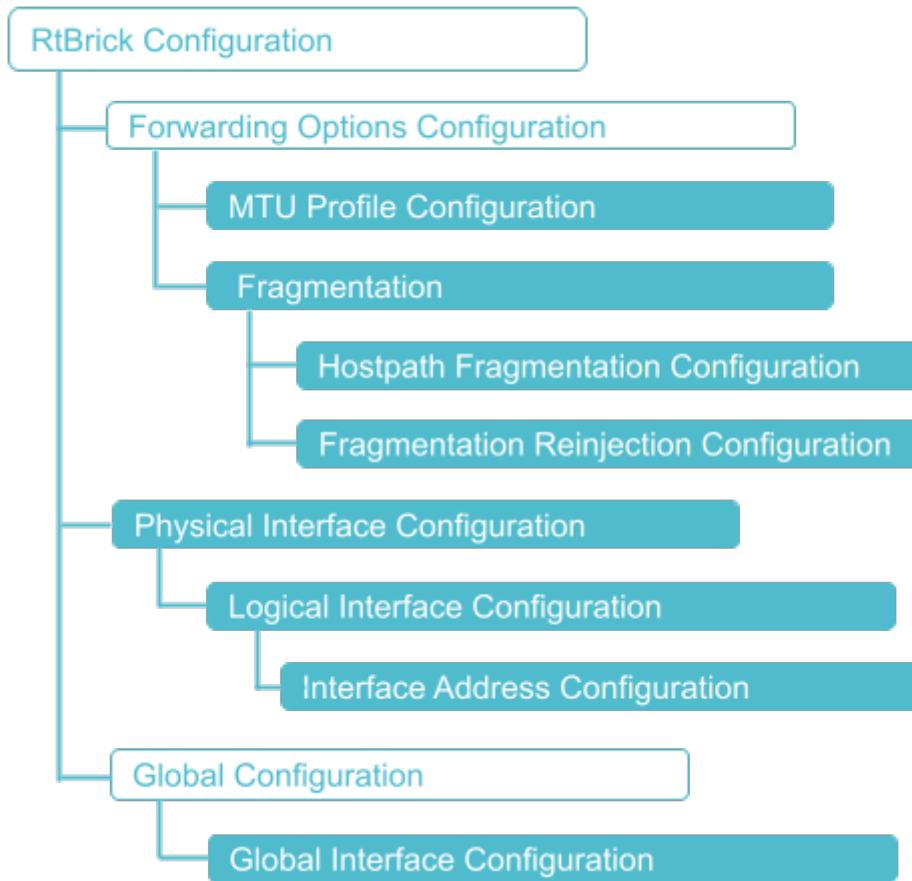

## Configuration Syntax and Commands

The following sections describe the interface configuration syntax and commands.

### MTU Profile Configuration

This section describes how to configure MTU profiles.

Syntax:

**set forwarding-options mtu-profile** <attribute> <value>

Attribute	Description
mtu-profile <mtu-profile-name>	MTU profile name
mtu-size <mtu-size>	MTU size. Range: 64 to 9216 bytes

Attribute	Description
mtu-type <mtu-type>	Specify the MTU type: <ul style="list-style-type: none"> <li>• <b>physical</b>: Port based MTU profile</li> <li>• <b>pppoe</b>: subscriber IFL-based MTU profile for L2TP and PPPoE. This MTU profile is used by PPPoE subscribers to set the default MTU size of 1492. A configured size of 1492 bytes limits the size of the IPv4 or IPv6 header plus payload.</li> <li>• <b>ipv4</b>: MTU profile of type IPv4. Only IPv4 traffic on the logical interface will be impacted.</li> <li>• <b>ipv6</b>: MTU profile of type IPv6. Only IPv6 traffic on the logical interface will be impacted.</li> <li>• <b>ip</b>: MTU profile of type IP. Both IPv4 and IPv6 traffic on the logical interface will be impacted.</li> </ul>
action <mtu-action>	Specify the MTU action. The following options are supported: <p><b>drop</b>: This indicates that when the MTU check fails, the action "drop" is performed.</p> <p><b>redirect-to-cpu</b>: This is an action of redirecting packets to the CPU in a traffic behavior. A <b>redirect-to-cpu</b> action must be configured for fragmentation to occur.</p>

### Example 1: Configuration of the MTU Profile for the Physical Port

```

{
  "ietf-restconf:data": {
    "rtbrick-config:forwarding-options": {
      "mtu-profile": [
        {
          "mtu-profile-name": "portMtu",
          "size": 5000,
          "type": "physical",
          "action": "redirect-to-cpu"
        }
      ]
    }
  }
}
    
```

### Example 2: MTU Profile Configuration of Type IPv4

```
{
  "ietf-restconf:data": {
    "rtbrick-config:forwarding-options": {
      "mtu-profile": [
        {
          "mtu-profile-name": "ipv4Mtu",
          "size": 1300,
          "type": "ipv4",
          "action": "redirect-to-cpu"
        }
      ]
    }
  }
}
```

### Example 3: MTU Profile Configuration of Type IPv6

```
{
  "ietf-restconf:data": {
    "rtbrick-config:forwarding-options": {
      "mtu-profile": [
        {
          "mtu-profile-name": "ipv6Mtu",
          "size": 1400,
          "type": "ipv6",
          "action": "redirect-to-cpu"
        }
      ]
    }
  }
}
```

### Example 4: Configuration of the MTU Profile for PPPoE

```
{
  "ietf-restconf:data": {
    "rtbrick-config:forwarding-options": {
      "mtu-profile": [
        {
          "mtu-profile-name": "pppoeMtu",
          "size": 1492,
          "type": "pppoe",
          "action": "redirect-to-cpu"
        }
      ]
    }
  }
}
```

## Enabling Hostpath Fragmentation

This section describes how to enable or disable fragmentation by CPU. It is necessary to configure MTU profile action "redirect-to-cpu" so that fragmentation takes place. By default, fragmentation is disabled.

Syntax:

**set forwarding-options fragmentation ipv4 state <value>**

Attribute	Description
disabled   cpu	Enables fragmentation of IPv4 packets. There are two options: disabled—Fragmentation is disabled. It is the default setting. cpu—Fragmentation is performed by CPU.

Example: Configuration of Hostpath Fragmentation

```
{
  "ietf-restconf:data": {
    "rtbrick-config:forwarding-options": {
      "fragmentation": {
        "ipv4": {
          "state": "cpu"
        }
      }
    }
  }
}
```

## Physical Interface Configuration

This section describes configuration options at the physical interface (IFP) level.

Syntax:

**set interface <interface-name> <attribute> <value>**

Attribute	Description
<interface-name>	Name of the interface. Example: ifp-0/0/1.
admin-status <down   up>	Administrative state of the interface.

Attribute	Description
auto-negotiation true	Enable auto-negotiation. Note: To disable auto-negotiation, use the <b>delete</b> form of the command. NOTE: Port speed configuration and auto-negotiation are mutually exclusive.
holddown <disable   enable>	Enable or disable the holddown timer feature. By default, the feature is enabled.
holddown-down-delay <...>	Configure the down delay time in milliseconds (ms).
holddown-up-delay <...>	Configure the down delay time in milliseconds (ms).
class-of-service <profile-name>	Apply class-of-service profile name.
description	Configure physical interface description.
host-if <container-interface>	Configure a host interface. For example, if the container interface eth1 connects to the host interface vethXYZ123, use this command option to bound hostif-0/0/1 to eth1. Please note the Linux virtual ethernet (veth) interface needs to be created separately. It cannot be created via RBFS configuration.
forward-error-correction <fec-type>	<p>Configure Forward Error Correction (FEC) on the physical interface. FEC allows you to send the required information to correct errors through the link along with the payload data. A benefit of "forward" in FEC is that errors detected at the receiver do not need to be retransmitted. Currently, the supported FEC types are: base-r, rsfec, none.</p> <p>NOTE: <b>rsfec</b> is the only FEC supported for 100G on the QAX platform.</p>
link-training true	Enable link training. Note: To disable link training, use the <b>delete</b> form of the command.

Attribute	Description
master <true false>	Memif role, master or slave, applicable only to memif interface. One end needs to be configured as master, and the other one as slave.
memif-id <id>	Configure memif ID, applicable only to memif interface. Needs to match on both ends.
mtu-profile <mtu-profile-name>	Attach MTU profile to a physical interface. This is a mandatory attribute.
mru <size>	Maximum receive unit size on the physical interface.
speed <speed>	<p>Configure speed mode for the interface. Port speed refers to the maximum amount of data transmitted. The speed value is specified in Gigabits per second (Gbps).</p> <p>Currently, RBFS supports 10G and 100G ports, and you can make the following changes:</p> <ul style="list-style-type: none"> <li>• 100G port speed can be changed to 40G</li> <li>• 10G port speed can be changed to 1G</li> </ul>

### Example 1: Physical Interface Configuration

```

{
  "rtbrick-config:interface": [
    {
      "name": "ifp-0/0/1",
      "description": "Link to leaf1",
      "speed": "10G",
      "mtu-profile": "portMtu",
      "mru": 5000
    }
  ]
}

```

### Example 2: Memory Interface Configuration

A End:

```

{

```



```

"rtbrick-config:interface": [
  {
    "name": "ifp-0/0/1",
    "description": "Master",
    "memif-id": 11,
    "master": "true",
  }
]
}

```

**B End:**

```

{
  "rtbrick-config:interface": [
    {
      "name": "ifp-0/0/1",
      "description": "Slave",
      "memif-id": 11,
      "master": "false",
    }
  ]
}

```

### Example 3: Host Interface Configuration

```

{
  "rtbrick-config:interface": [
    {
      "name": "ifp-0/0/1",
      "description": "Represents eth1 as ifp-0/0/1 in RBFS",
      "host-if": "eth1",
    }
  ]
}

```

### Example 4: MRU Configuration for Physical Interface

```

{
  "rtbrick-config:interface": [
    {
      "name": "ifp-0/0/7",
      "mru": 5000
    }
  ]
}

```

### Example 5: FEC Configuration for Physical Interface

```

{
  "rtbrick-config:interface": [
    {
      "name": "ifp-0/0/40",
      "forward-error-correction": "base-r"
    }
  ]
}

```

```

    }
  ]
}

```

## Logical Interface Configuration

This section describes configuration options at the logical interface (IFL) level.

Syntax:

**set interface** <interface-name> **unit** <unit-id> <attribute> <value>

Attribute	Description
unit <unit-id>	Create a logical interface (also referred to as a sub-interface) under the physical interface.
admin-status <down   up>	Administrative state of the logical interface.
class-of-service <profile-name>	Apply class-of-service profile name.
description <description>	Description of the logical interface.
inner-vlan <inner-vlan-id>	Inner VLAN ID.
instance <instance>	Assign the logical interface to an instance.
ipv4-admin-status <down   up>	Enable or disable IPv4.
ipv4-mtu-profile <ipv4-mtu-profile>	Attach IPv4 MTU profile to an L3 interface.
ipv6-admin-status <down   up>	Enable or disable IPv6.
ipv6-mtu-profile <ipv6-mtu-profile>	Attach IPv6 MTU profile to an L3 interface.
ip-mtu-profile <ip-mtu-profile>	Attach IP MTU profile to an L3 interface.
mpls-admin-status <down   up>	Enable or disable MPLS.
mpls-mtu <mpls-mtu-size>	MPLS maximum transmission unit size.

Attribute	Description
neighbor <ipv4   ipv6> <ip-address> mac <mac-address>	Configure a static IPv4 or IPv6 neighbor.
unnumbered interface <loopback-interface-name>	Configure an un-numbered interface.
vlan <outer-vlan-id>	Outer VLAN ID.
vlan-encapsulation <802.1ad   802.1q>	Specify the outer VLAN tag.

### Example 1: Logical Interface Configuration with IPv4 MTU Profile

```
{
  "rtbrick-config:interface": [
    {
      "name": "ifp-0/0/1",
      "unit": [
        {
          "unit-id": 1,
          "description": "VLAN 101",
          "instance": "default",
          "ipv4-mtu-profile": "ipv4Mtu"
        }
      ]
    }
  ]
}
```

### Example 2: Logical Interface Configuration with IPv6 MTU Profile

```
{
  "rtbrick-config:interface": [
    {
      "name": "ifp-0/0/1",
      "unit": [
        {
          "unit-id": 1,
          "description": "VLAN 101",
          "instance": "default",
          "ipv6-mtu-profile": "ipv6Mtu"
        }
      ]
    }
  ]
}
```

### Example 3: Logical Interface Configuration with IP MTU Profile

```
{
  "rtbrick-config:interface": [
    {
      "name": "ifp-0/0/1",
      "unit": [
        {
          "unit-id": 1,
          "description": "VLAN 101",
          "instance": "default",
          "ip-mtu-profile": "ipMtu"
        }
      ]
    }
  ]
}
```

### Interface Address Configuration

This section describes how to configure interface IP addresses.

Syntax:

**set interface** <interface-name> **unit** <unit-id> **address** <afi> <attribute> <value>

Attribute	Description
<afi>	Address family identifier (AFI). Supported values: ipv4 and ipv6
<prefix4 prefix6>	Assign IPv4 or IPv6 address to the interface unit.
community <community-value>	Configure list of communities associated with the address.
extended-community <community-value>	Configure list of extended communities associated with the address.
label <label-value>	Configure label associated with the address. Supported MPLS label values are 0 - 1048575. The reserved MPLS label range is 0 - 15. In RBFS, BGP uses the label range 20000 - 100000. It is recommended to assign label values outside of these reserved ranges to avoid conflicts.

Attribute	Description
secondary true	Enable a secondary IPv4 address. Note: To disable the <b>secondary</b> IP configuration, use the <b>delete</b> form of the command.



Broadcast and network IP addresses cannot be configured on logical (IFL) interfaces.

### Example: Interface Address Configuration

```
{
  "rtbrick-config:interface": [
    {
      "name": "lo-0/0/1",
      "unit": [
        {
          "unit-id": 1,
          "address": {
            "ipv4": [
              {
                "prefix4": "198.51.100.103/24",
                "label": 12346
              }
            ]
          }
        }
      ]
    }
  ]
}
```

### Global Interface Configuration

This section describes a configuration option applied globally to all interfaces.

Syntax:

**set global interface all** <attribute> <value>

Attribute	Description
admin-status <up down>	Configure state of the interface.



- The interface level enable/disable command has higher precedence than the global interface enable/disable command.

- You can disable all unused physical interfaces.
- Before executing the global interface disable all command ensure that all physical interfaces are in the link Up state.

### Example: Enabling or Disabling all Interfaces

```
{
  "ietf-restconf:data": {
    "rtbrick-config:global": {
      "interface": {
        "all": {
          "admin-status": "down"
        }
      }
    }
  }
}
```

### Interface Holddown Configuration

By default, the Interface Hold-down feature is enabled. You can disable the feature if you want. It is allowed to configure timer value for options such as 'holddown down delay' and 'holddown up delay'.

Syntax:

**set interface** <interface-name> <attribute> <value>

Attribute	Description
<interface-name>	Name of the interface. Example: ifp-0/0/1.
holddown <disable   enable>	Enable or disable the holddown timer feature. By default, the feature is enabled.
holddown-down-delay	Configure the down delay time in milliseconds (ms). The allowed values include 0, 100, 200, 500, 1000, 2000, 5000, and 10000. It overrides the default delay of '0' milliseconds.
holddown-up-delay	Configure the up delay time milliseconds (ms). The allowed values include 0, 100, 200, 500, 1000, 2000, 5000, and 10000.

## Enabling Gratuitous ARP on Interface

You can enable or disable the sending of Gratuitous ARP (GARP) on an interface. This section describes enabling or disabling GARP on an interface.

### Syntax:

**set interface** <interface-name> **unit** <unit-id> **gratituous-arp** <enable | disable>

Attribute	Description
interface <interface-name>	Name of the interface. Examples: ifp-0/0/1.
gratituous-arp	Specify enable or disable.

Example: Enabling Gratuitous ARP

```
supervisor@rtbrick.net: cfg> set interface hostif-0/0/0 unit 100 gratuitous-arp
enable|disable
```

## Breakout Interfaces

Using the breakout configuration, the high-speed interfaces(100G) on the UfiSpace S9600-32X platform can be divided into multiple lower-speed interfaces(10G or 25G), allowing them to connect with lower rate ports(10G or 25G) in other network devices.

RBFS supports the following breakout configuration options:

Rate	Technology	Breakout Capable	Electric Lanes	Optical Lanes
100G	QSFP28	Yes	4 x 25G	4 x 25G
100G	QSFP28	Yes	4 x 10G	4 x 10G

For example, to set up the individual peer-side (25G/10G) interfaces, we need to configure the breakout on the 100G port to 4x10G or 4x25G based on the peer-side speed.

When a breakout is configured on a high-speed interface (for example, ifp-0/1/12), it is divided into four lower-speed interfaces: ifp-0/1/12#0, ifp-0/1/12#1, ifp-0/1/12#2, and ifp-0/1/12#3. As a result, the original high-speed interface will no

longer be available.

The following diagram shows the breakout for the interface ifp-0/1/12 on the high-speed 100G to 4x25G ports (#0, #1, #2, #3).

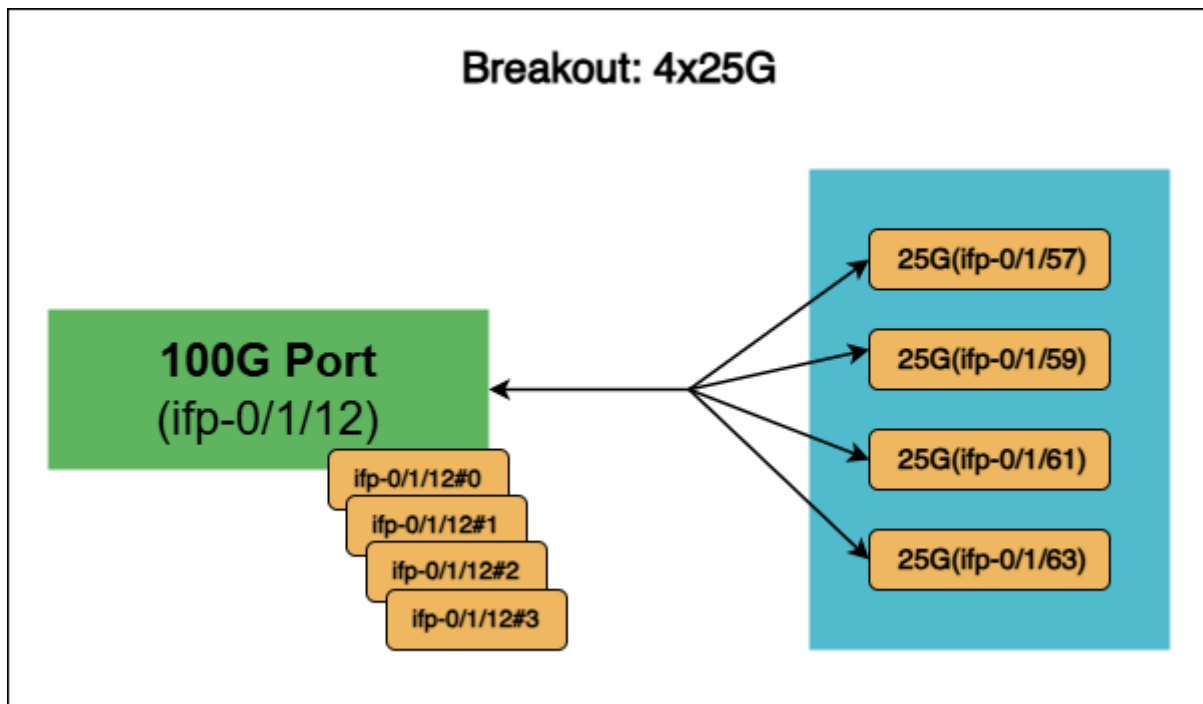

### Guidelines and Limitations

Currently, the following limitations exist.

- Autonegotiation, speed configuration, and traffic sampling are not supported for breakout interfaces.
- A breakout interface cannot be a member of a LAG.
- Using breakout interfaces with routing protocols is not supported.

### Configuring Breakout

To configure for the interface ifp-0/1/12 on the high-speed 100G to 4x25G ports., enter the following command:

#### Syntax:

```
set interface <interface-name> breakout map < 4x10G | 4x25G >
```

#### Example:



```
set interface ifp-0/1/12 breakout map 4x25G
```

## Viewing Breakout Configuration Details

To view the breakout configuration details, enter the following command:

```
show interface <interface-name> detail
```

### Example of Breakout Configuration:

```
supervisor@rtbrick>SPINE01: cfg> show interface ifp-0/1/12#0 detail
Interface: ifp-0/1/12#0
  Admin/Link/Operational status: Up/Up/Up
  Damping Status: holddown
  Breakout: 4x25G
  Speed configured: 25G
  Speed maximum: 25G
  Duplex: Full
  Encapsulation mode: ieee
  MRU: 10000
  MTU: 9000
  Maximum frame size: 10000
  Interface type: ethernet
  Interface index: 100609
  MAC: e8:c5:7a:8f:56:c6
  Uptime: Mon Nov 25 05:37:10 GMT +0000 2024, Holddown up/down delay: 10000ms/0ms
  Flap count: 1
  Holddown transitions: 1
  Description: Physical interface #12 from node 0, chip 1
  LED Status: Off, LED programmed value: 82
  Packet statistics:
    Rx packets: 3           Tx packets: 3
    Rx bytes: 381          Tx bytes: 387
```

```
supervisor@rtbrick>SPINE01: cfg> show interface ifp-0/1
/12#1 detail
Interface: ifp-0/1/12#1
  Admin/Link/Operational status: Up/Up/Up
  Damping Status: stable
  Breakout: 4x25G
  Speed configured: 25G
  Speed maximum: 25G
  Duplex: Full
  Encapsulation mode: ieee
  MRU: 10000
  MTU: 9000
  Maximum frame size: 10000
  Interface type: ethernet
  Interface index: 102657
  MAC: e8:c5:7a:8f:56:c7
  Uptime: Mon Nov 25 05:37:10 GMT +0000 2024, Holddown up/down delay: 10000ms/0ms
  Flap count: 1
  Holddown transitions: 1
```

```

Description: Physical interface #12 from node 0, chip 1
LED Status: Off, LED programmed value: 4
Packet statistics:
  Rx packets: 1           Tx packets: 1
  Rx bytes: 127          Tx bytes: 129
    
```

```

supervisor@rtbrick>SPINE01: cfg> show interface ifp-0/1
/12#2 detail
Interface: ifp-0/1/12#2
  Admin/Link/Operational status: Up/Up/Up
  Damping Status: stable
  Breakout: 4x25G
  Speed configured: 25G
  Speed maximum: 25G
  Duplex: Full
  Encapsulation mode: ieee
  MRU: 10000
  MTU: 9000
  Maximum frame size: 10000
  Interface type: ethernet
  Interface index: 104705
  MAC: e8:c5:7a:8f:56:c8
  Uptime: Mon Nov 25 05:37:10 GMT +0000 2024, Holddown up/down delay: 10000ms/0ms
  Flap count: 1
  Holddown transitions: 1
  Description: Physical interface #12 from node 0, chip 1
  LED Status: Off, LED programmed value: 0
  Packet statistics:
    Rx packets: 1           Tx packets: 1
    Rx bytes: 127          Tx bytes: 129
    
```

```

supervisor@rtbrick>SPINE01: cfg> show interface ifp-0/1
/12#3 detail
Interface: ifp-0/1/12#3
  Admin/Link/Operational status: Up/Up/Up
  Damping Status: stable
  Breakout: 4x25G
  Speed configured: 25G
  Speed maximum: 25G
  Duplex: Full
  Encapsulation mode: ieee
  MRU: 10000
  MTU: 9000
  Maximum frame size: 10000
  Interface type: ethernet
  Interface index: 106753
  MAC: e8:c5:7a:8f:56:c9
  Uptime: Mon Nov 25 05:37:10 GMT +0000 2024, Holddown up/down delay: 10000ms/0ms
  Flap count: 1
  Holddown transitions: 1
  Description: Physical interface #12 from node 0, chip 1
  LED Status: Off, LED programmed value: 0
  Packet statistics:
    Rx packets: 1           Tx packets: 1
    Rx bytes: 127          Tx bytes: 129
    
```

## 6.1.3. Interfaces Operational Commands

### Interface Show Commands

The interface show commands provide detailed information about the status and parameters of RBFS interfaces.

### Interface Summary Commands

Syntax:

**show interface** <option>

Option	Description
summary	Displays a summary of all interfaces including physical, logical, and address information.
<interface-name>	Displays a summary of an interface including physical, logical, and address information.
physical	Displays all physical interface including loopback, cpu and recycle ports.
logical	Displays all logical interfaces for all instances.
logical <instance-name>	Displays all logical interfaces for the given instance.
address	Displays all IPv4 and IPv6 addresses for all instances.
address <instance-name>	Displays all IPv4 and IPv6 addresses for the given instance.

### Example 1: Summary Output for All Interfaces

```

supervisor@rtbrick>LEAF01: op> show interface summary
Interface           Admin   Link   Oper           IPv4 Address           IPv6 Address
ifp-0/0/1           Up      Down  Down
ifp-0/0/2           Up      Down  Down
ifp-0/0/3           Up      Down  Down
ifp-0/0/4           Up      Up     Up
ifp-0/0/5           Up      Down  Down
ifp-0/0/6           Up      Down  Down
ifp-0/0/7           Up      Down  Down
ifp-0/0/8           Up      Down  Down
ifp-0/0/9           Up      Down  Down
ifp-0/0/10          Up      Up     Up
ifl-0/0/10/100      Up      Up     Up             198.51.100.22/24      2001:db8:0:100::/32
ifl-0/0/10/200      Up      Up     Up             198.51.100.32/24      2001:db8:0:10::/32
ifl-0/0/10/300      Up      Up     Up             -                     2001:db8:0:160::/32
ifp-0/0/11          Up      Down  Down
ifp-0/0/12          Up      Down  Down

```

ifp-0/0/13	Up	Down	Down
ifp-0/0/14	Up	Down	Down
ifp-0/0/15	Up	Down	Down
ifp-0/0/16	Up	Down	Down
ifp-0/0/17	Up	Down	Down
ifp-0/0/18	Up	Down	Down
ifp-0/0/19	Up	Down	Down
ifp-0/0/20	Up	Down	Down
ifp-0/0/21	Up	Down	Down
ifp-0/0/22	Up	Down	Down
ifp-0/0/23	Up	Down	Down
ifp-0/0/24	Up	Down	Down
ifp-0/0/25	Up	Down	Down
ifp-0/0/26	Up	Down	Down
ifp-0/0/27	Up	Up	Up
ifp-0/0/28	Up	Down	Down
ifp-0/0/29	Up	Down	Down
ifp-0/0/30	Up	Down	Down
ifp-0/0/31	Up	Down	Down
ifp-0/0/32	Up	Down	Down
ifp-0/0/33	Up	Down	Down
ifp-0/0/34	Up	Down	Down
ifp-0/0/35	Up	Down	Down
ifp-0/0/36	Up	Down	Down
ifp-0/0/37	Up	Down	Down
ifp-0/0/38	Up	Down	Down
ifp-0/0/39	Up	Down	Down
ifp-0/0/40	Up	Down	Down
ifp-0/0/41	Up	Down	Down
ifp-0/0/42	Up	Down	Down
ifp-0/0/43	Up	Down	Down
ifp-0/0/44	Up	Down	Down
ifp-0/0/45	Up	Down	Down
ifp-0/0/46	Up	Down	Down
ifp-0/0/47	Up	Down	Down
ifp-0/0/48	Up	Down	Down
ifp-0/0/49	Up	Down	Down
ifp-0/0/50	Up	Down	Down
ifp-0/0/51	Up	Down	Down
ifp-0/0/52	Up	Up	Up
ifp-0/0/53	Up	Up	Up
ifp-0/0/54	Up	Down	Down
cpu-0/0/200	Up	Up	Up
cpu-0/0/201	Up	Down	Down
cpu-0/0/202	Up	Down	Down
cpu-0/0/203	Up	Down	Down
recycle-0/0/75	Up	Up	Up
recycle-0/0/75/0	Up	Up	Up
recycle-0/0/76	Up	Up	Up
recycle-0/0/76/0	Up	Up	Up

### Example 2: Summary Output for One Physical Interface

```
supervisor@rtbrick>LEAF01: op> show interface ifp-0/0/10
```

Interface	Admin	Link	Oper	IPv4 Address	IPv6 Address
ifp-0/0/10	Up	Up	Up		
ifl-0/0/10/100	Up	Up	Up	198.51.100.22/24	2001:db8:0:100::/32
ifl-0/0/10/200	Up	Up	Up	198.51.100.32/24	2001:db8:0:10::/32
ifl-0/0/10/300	Up	Up	Up	-	2001:db8:0:160::/32
ifl-0/0/10/1000	Up	Up	Up	-	2001:db8:0:33::/32

### Example 3: List of All Physical Interfaces

```
supervisor@rtbrick>LEAF01: op> show interface physical
```

Interface	Admin	Link	Oper	MAC Address	Speed	Duplex	Uptime
-----------	-------	------	------	-------------	-------	--------	--------

1o-0/0/1 2020	Up	Up	Up	80:a2:35:a0:00:01	-	-	Thu Nov 19 10:41:06 GMT +0000
ifp-0/0/1 2020	Up	Down	Down	80:a2:35:ee:a8:01	10G	Full	Mon Nov 16 11:24:09 GMT +0000
ifp-0/0/2 2020	Up	Down	Down	80:a2:35:ee:a8:02	10G	Full	Mon Nov 16 11:24:09 GMT +0000
ifp-0/0/3 2020	Up	Down	Down	80:a2:35:ee:a8:03	10G	Full	Mon Nov 16 11:24:09 GMT +0000
ifp-0/0/4 2020	Up	Up	Up	80:a2:35:ee:a8:04	10G	Full	Thu Nov 19 10:05:02 GMT +0000
ifp-0/0/5 2020	Up	Down	Down	80:a2:35:ee:a8:05	10G	Full	Mon Nov 16 11:24:09 GMT +0000
ifp-0/0/6 2020	Up	Down	Down	80:a2:35:ee:a8:06	10G	Full	Mon Nov 16 11:24:09 GMT +0000
ifp-0/0/7 2020	Up	Down	Down	80:a2:35:ee:a8:07	10G	Full	Mon Nov 16 11:24:09 GMT +0000
ifp-0/0/8 2020	Up	Down	Down	80:a2:35:ee:a8:08	10G	Full	Mon Nov 16 11:24:09 GMT +0000
ifp-0/0/9 2020	Up	Down	Down	80:a2:35:ee:a8:09	10G	Full	Mon Nov 16 11:24:09 GMT +0000
ifp-0/0/10 2020	Up	Up	Up	80:a2:35:ee:a8:0a	10G	Full	Fri Nov 20 00:59:12 GMT +0000
ifp-0/0/11 2020	Up	Down	Down	80:a2:35:ee:a8:0b	10G	Full	Mon Nov 16 11:24:09 GMT +0000
ifp-0/0/12 2020	Up	Down	Down	80:a2:35:ee:a8:0c	10G	Full	Mon Nov 16 11:24:09 GMT +0000
ifp-0/0/13 2020	Up	Down	Down	80:a2:35:ee:a8:0d	10G	Full	Mon Nov 16 11:24:09 GMT +0000
ifp-0/0/14 2020	Up	Down	Down	80:a2:35:ee:a8:0e	10G	Full	Mon Nov 16 11:24:09 GMT +0000
ifp-0/0/15 2020	Up	Down	Down	80:a2:35:ee:a8:0f	10G	Full	Mon Nov 16 11:24:09 GMT +0000
ifp-0/0/16 2020	Up	Down	Down	80:a2:35:ee:a8:10	10G	Full	Mon Nov 16 11:24:09 GMT +0000
ifp-0/0/17 2020	Up	Down	Down	80:a2:35:ee:a8:11	10G	Full	Mon Nov 16 11:24:09 GMT +0000
ifp-0/0/18 2020	Up	Down	Down	80:a2:35:ee:a8:12	10G	Full	Mon Nov 16 11:24:09 GMT +0000
ifp-0/0/19 2020	Up	Down	Down	80:a2:35:ee:a8:13	10G	Full	Mon Nov 16 11:24:09 GMT +0000
ifp-0/0/20 2020	Up	Down	Down	80:a2:35:ee:a8:14	10G	Full	Mon Nov 16 11:24:09 GMT +0000
ifp-0/0/21 2020	Up	Down	Down	80:a2:35:ee:a8:15	10G	Full	Mon Nov 16 11:24:09 GMT +0000
ifp-0/0/22 2020	Up	Down	Down	80:a2:35:ee:a8:16	10G	Full	Mon Nov 16 11:24:09 GMT +0000
ifp-0/0/23 2020	Up	Down	Down	80:a2:35:ee:a8:17	10G	Full	Mon Nov 16 11:24:09 GMT +0000
ifp-0/0/24 2020	Up	Down	Down	80:a2:35:ee:a8:18	10G	Full	Mon Nov 16 11:24:09 GMT +0000
ifp-0/0/25 2020	Up	Down	Down	80:a2:35:ee:a8:19	10G	Full	Mon Nov 16 11:24:09 GMT +0000
ifp-0/0/26 2020	Up	Down	Down	80:a2:35:ee:a8:1a	10G	Full	Mon Nov 16 11:24:09 GMT +0000
ifp-0/0/27 2020	Up	Up	Up	80:a2:35:ee:a8:1b	10G	Full	Fri Nov 20 00:59:11 GMT +0000
ifp-0/0/28 2020	Up	Down	Down	80:a2:35:ee:a8:1c	10G	Full	Mon Nov 16 11:24:09 GMT +0000
ifp-0/0/29 2020	Up	Down	Down	80:a2:35:ee:a8:1d	10G	Full	Mon Nov 16 11:24:09 GMT +0000
ifp-0/0/30 2020	Up	Down	Down	80:a2:35:ee:a8:1e	10G	Full	Mon Nov 16 11:24:09 GMT +0000
ifp-0/0/31 2020	Up	Down	Down	80:a2:35:ee:a8:1f	10G	Full	Mon Nov 16 11:24:09 GMT +0000
ifp-0/0/32 2020	Up	Down	Down	80:a2:35:ee:a8:20	10G	Full	Mon Nov 16 11:24:09 GMT +0000
ifp-0/0/33 2020	Up	Down	Down	80:a2:35:ee:a8:21	10G	Full	Mon Nov 16 11:24:09 GMT +0000
ifp-0/0/34 2020	Up	Down	Down	80:a2:35:ee:a8:22	10G	Full	Mon Nov 16 11:24:09 GMT +0000
ifp-0/0/35 2020	Up	Down	Down	80:a2:35:ee:a8:23	10G	Full	Mon Nov 16 11:24:09 GMT +0000
ifp-0/0/36 2020	Up	Down	Down	80:a2:35:ee:a8:24	10G	Full	Mon Nov 16 11:24:09 GMT +0000
ifp-0/0/37 2020	Up	Down	Down	80:a2:35:ee:a8:25	10G	Full	Mon Nov 16 11:24:09 GMT +0000
ifp-0/0/38	Up	Down	Down	80:a2:35:ee:a8:26	10G	Full	Mon Nov 16 11:24:09 GMT +0000

```

2020
ifp-0/0/39      Up      Down   Down   80:a2:35:ee:a8:27   10G   Full   Mon Nov 16 11:24:09 GMT +0000
2020
ifp-0/0/40      Up      Down   Down   80:a2:35:ee:a8:28   10G   Full   Mon Nov 16 11:24:09 GMT +0000
2020
ifp-0/0/41      Up      Down   Down   80:a2:35:ee:a8:29   10G   Full   Mon Nov 16 11:24:09 GMT +0000
2020
ifp-0/0/42      Up      Down   Down   80:a2:35:ee:a8:2a   10G   Full   Mon Nov 16 11:24:09 GMT +0000
2020
ifp-0/0/43      Up      Down   Down   80:a2:35:ee:a8:2b   10G   Full   Mon Nov 16 11:24:09 GMT +0000
2020
ifp-0/0/44      Up      Down   Down   80:a2:35:ee:a8:2c   10G   Full   Mon Nov 16 11:24:09 GMT +0000
2020
ifp-0/0/45      Up      Down   Down   80:a2:35:ee:a8:2d   10G   Full   Mon Nov 16 11:24:09 GMT +0000
2020
ifp-0/0/46      Up      Down   Down   80:a2:35:ee:a8:2e   10G   Full   Mon Nov 16 11:24:09 GMT +0000
2020
ifp-0/0/47      Up      Down   Down   80:a2:35:ee:a8:2f   10G   Full   Mon Nov 16 11:24:09 GMT +0000
2020
ifp-0/0/48      Up      Down   Down   80:a2:35:ee:a8:30   10G   Full   Mon Nov 16 11:24:09 GMT +0000
2020
ifp-0/0/49      Up      Down   Down   80:a2:35:ee:a8:31   100G  Full   Mon Nov 16 11:24:09 GMT +0000
2020
ifp-0/0/50      Up      Down   Down   80:a2:35:ee:a8:35   100G  Full   Mon Nov 16 11:24:09 GMT +0000
2020
ifp-0/0/51      Up      Down   Down   80:a2:35:ee:a8:39   100G  Full   Mon Nov 16 11:24:09 GMT +0000
2020
ifp-0/0/52      Up      Up     Up     80:a2:35:ee:a8:3d   100G  Full   Tue Nov 17 14:10:46 GMT +0000
2020
ifp-0/0/53      Up      Up     Up     80:a2:35:ee:a8:41   100G  Full   Fri Nov 20 00:59:12 GMT +0000
2020
ifp-0/0/54      Up      Down   Down   80:a2:35:ee:a8:45   100G  Full   Mon Nov 16 11:24:09 GMT +0000
2020
cpu-0/0/200     Up      Up     Up     80:a2:35:ee:a8:c8   100G  Full   Mon Nov 16 11:24:11 GMT +0000
2020
cpu-0/0/201     Up      Down   Down   80:a2:35:ee:a8:c9   100G  Full   Mon Nov 16 11:24:09 GMT +0000
2020
cpu-0/0/202     Up      Down   Down   80:a2:35:ee:a8:ca   100G  Full   Mon Nov 16 11:24:09 GMT +0000
2020
cpu-0/0/203     Up      Down   Down   80:a2:35:ee:a8:cb   100G  Full   Mon Nov 16 11:24:09 GMT +0000
2020
recycle-0/0/75  Up      Up     Up     80:a2:35:ee:a8:4b   100G  Full   Mon Nov 16 11:24:11 GMT +0000
2020
recycle-0/0/76  Up      Up     Up     80:a2:35:ee:a8:4c   100G  Full   Mon Nov 16 11:24:11 GMT +0000
2020
    
```

### Example 4: List of All Logical Interfaces for All Instances

```

supervisor@rtbrick>LEAF01: op> show interface logical
Interface          Instance      Admin  Link  Oper  Outer VLAN  Inner VLAN  IPv4 Status,MTU
IPv6 Status,MTU
if1-0/0/10/100    default      Up     Up    Up    -           -           Up,1500
Up,1500
if1-0/0/10/200    default      Up     Up    Up    200        -           Up,1500
Up,1500
if1-0/0/10/300    default      Up     Up    Up    300        -           Up,1500
Up,1500
    
```

### Example 5: List of Logical Interfaces for an Instance

```

supervisor@rtbrick: op> show interface logical instance default
Interface          Instance      Admin  Link  Oper  Outer VLAN  Inner VLAN  IPv4 Status,MTU
IPv6 Status,MTU
if1-0/0/10/100    default      Up     Up    Up    -           -           Up,1500
Up,1500
if1-0/0/10/200    default      Up     Up    Up    200        -           Up,1500
Up,1500
if1-0/0/10/300    default      Up     Up    Up    300        -           Up,1500
    
```

Up,1500

## Example 6: List of All Interface Addresses

```

supervisor@rtbrick: op> show interface address
Interface          Instance      IPv4 Address      IPv4 Primary      IPv6 Address
ifl-0/0/10/100    default      198.51.100.22/24  True              2001:db8:0:100::/32
ifl-0/0/10/200    default      198.51.100.32/24  True              2001:db8:0:10::/32
ifl-0/0/10/300    default      -                  -                  2001:db8:0:160::/32
    
```

## Interface Details Commands

Syntax:

**show interface <option> detail**

Option	Description
detail	Without any additional option, displays detailed information for all interfaces.
<interface-name> detail	Displays detailed information for an interface.

## Example 7: Detailed Information for a Physical Interface and Its Logical Interfaces

```

supervisor@rtbrick: op> show interface ifp-0/0/10 detail
Interface:ifp-0/0/10
  Admin/Link/Operational status: Up/Up/Up
  MRU: 10000
  MTU: 1514
  Interface type: ifp
  Interface index: 8198
  MAC: 7a:4a:14:c0:00:04
  Uptime: Thu Apr 11 05:57:42 GMT +0000 2024
  Flap count: 2
  Description: Physical interface #4 from node 0, chip 0
  Interface: ifp-0/0/10, Instance: default
  Admin/Link/Operational status: Up/Up/Up
  IPv4/IPv6/MPLS Status: Up/Up/Up
  IPv4/IPv6/MPLS MTU: 1500/1500/1500
  Interface type: Logical Sub interface
  Interface index: 532486
  MAC: 7a:4a:14:c0:00:04
  IPv4 Address          IPv6 Address
  192.0.2.0/24         2001:DB8::/64
    
```

The following output shows the interface holddown details such as the damping state, transitions, and delay.

```

supervisor@rtbrick.net: cfg> show interface ifp-0/1/20 detail
Interface:ifp-0/1/20
  Admin/Link/Operational status: Up/Up/Up
  Damping Status: stable
  Speed configured: 10G
  Speed maximum: 25G
  Duplex: Full
  Encapsulation mode: ieee
  MRU: 10000
  MTU: 9000
  Maximum frame size: 10000
  Interface type: ethernet
  Interface index: 43265
  MAC: e8:c5:7a:b2:04:b4
  Uptime: Fri Jul 05 06:19:12 GMT +0000 2024, Holddown up/down delay: 10000ms/0ms
  Flap count: 1
  Holddown transitions: 1
  Description: Physical interface #20 from node 0, chip 1
  Packet statistics:
    Rx packets: 59          Tx packets: 59
    Rx bytes: 7493         Tx bytes: 7493
supervisor@rtbrick>ufil5.q2c.u15.r5.nbg.rtbrick

```

## MTU Profile Show Command

Syntax:

**show mtu profile** <option>

Option	Description
-	Without any additional option, displays detailed information for all MTU profiles.
profile-name <mtu-profile-name>	MTU Profile Name

### Example 8: Detailed Information About the MTU Profiles

```

supervisor@rtbrick>LEAF01: op> show mtu profile
Profile Name          Type      Size  Action
__default_ppoe__    pppoe    1492  drop
l3IpMtu              ipv4     1300  drop
l3Ipv6Mtu           ipv6     1300  drop
portMtu             physical  1300  drop
portM2              physical  1400  drop
portM5              physical  1430  drop
supervisor@rtbrick>LEAF01: op>

```

### Example 9: Display Information About the Specified MTU Profile



```

supervisor@rtbrick>LEAF01: op> show mtu profile profile-name l3IpMtu
Profile Name          Type          Size  Action
l3IpMtu              ipv4         1300  drop
supervisor@rtbrick>LEAF01: op>
    
```

## Interface Statistics Commands

Syntax:

**show interface** <option> **statistics**

Option	Description
statistics	Without any additional option, displays statistics information for all interfaces.
<interface-name> statistics	Displays statistics information for an interface.

### Example 10: Statistics Information for a Physical Interface and Its Logical Interfaces

```

supervisor@rtbrick>LEAF01: op> show interface ifp-0/0/10 statistics
Interface:  ifp-0/0/10
  Counter          Direction  Unit          Rx          Rx Diff    Rx Rate    Tx          Tx Diff    Tx Rate
  IPv4             -         Packets      -           -           -           -           -           -
  IPv4             -         Bytes        -           -           -           -           -           -
  IPv6             -         Packets      -           -           -           -           -           -
  IPv6             -         Bytes        -           -           -           -           -           -
  MPLS             -         Packets      -           -           -           -           -           -
  MPLS             -         Bytes        -           -           -           -           -           -
  Punt             -         Packets      -           -           -           -           -           -
  Punt             -         Bytes        -           -           -           -           -           -
  Miss             RX        Packets      -           -           -           -           -           -
  Miss             RX        Bytes        -           -           -           -           -           -
  Drops            -         Packets      4995        -           -           -           -           -
  Drops            -         Bytes        -           -           -           -           -           -
  Error            RX        Packets      -           -           -           -           -           -
  Error            RX        Bytes        -           -           -           -           -           -
  Error            TX        Packets      47          -           -           -           -           -
  Error            TX        Bytes        -           -           -           -           -           -
  No Buff          RX        Packets      -           -           -           -           -           -
  No Buff          RX        Bytes        -           -           -           -           -           -
  Traffic Statistics -         Packets      4995        -           -           68492      -           -
  Traffic Statistics -         Bytes        489510     -           -           5869876   -           -
  Unicast Statistics -         Packets      -           -           -           -           -           -
  Unicast Statistics -         Bytes        -           -           -           -           -           -
  Broadcast Statistics -         Packets      -           -           -           -           -           -
  Broadcast Statistics -         Bytes        -           -           -           -           -           -
  Multicast Statistics -         Packets      -           -           -           -           -           -
  Multicast Statistics -         Bytes        -           -           -           -           -           -
  Bcm Statistics:
  inOctets:                511632
  inUcastPkts:              0
  inNonUcastPkts:          5016
  inErrors:                  0
  inUnknownProtos:         0
  outOctets:                6236484
  outUcastPkts:              0
  outNonUcastPkts:         68492
  outErrors:                  0
  etherStatsDropEvents:     0
    
```

```

etherStatsMulticastPkts: 67718
etherStatsBroadcastPkts: 5790
etherStatsUndersizePkts: 0
etherStatsFragments: 0
etherStatsOversizePkts: 0
etherStatsOctets: 6748116
etherStatsPkts: 73508
etherStatsCollisions: 0
etherStatsTXNoErrors: 68492
etherStatsRXNoErrors: 5016
ifInMulticastPkts: 5016
ifOutBroadcastPkts: 5790
ifOutMulticastPkts: 62702
ifOutBroadcastPkts: 5790
bcmReceivedUndersizePkts: 0
bcmTransmittedUndersizePkts: 5790
bcmQmxDot1dBasePortDelayExceededDiscards: 0
bcmQmxDot1dBasePortMtuExceededDiscards: 0
bcmQmxDot1dTpPortInFrames: 5016
bcmQmxDot1dTpPortOutFrames: 68492
bcmQmxEtherStatsPkts64Octets: 5790
bcmQmxEtherStatsPkts128to255Octets: 24
bcmQmxEtherStatsPkts256to511Octets: 0
bcmQmxEtherStatsPkts512to1023Octets: 0
bcmQmxEtherStatsPkts1024to1518Octets: 0
bcmQmxEtherRxOversizePkts: 0
bcmQmxEtherTxOversizePkts: 0
bcmQmxEtherStatsJabbers: 0
bcmQmxEtherStatsCRCAlignErrors: 0
bcmQmxDot3StatsFCSErrors: 0
bcmQmxDot3StatsSingleCollisionFrames: 0
bcmQmxDot3StatsMultipleCollisionFrames: 0
bcmQmxDot3StatsSQETTestErrors: 0
bcmQmxDot3StatsDeferredTransmissions: 0
bcmQmxDot3StatsLateCollisions: 0
bcmQmxDot3StatsExcessiveCollisions: 0
bcmQmxDot3StatsInternalMacTransmitErrors: 0
bcmQmxDot3StatsCarrierSenseErrors: 0
bcmQmxDot3StatsFrameTooLongs: 0
bcmQmxDot3StatsInternalMacReceiveErrors: 0
bcmQmxDot3StatsSymbolErrors: 0
bcmQmxDot3ControlInUnknownOpcodes: 0
bcmQmxDot3InPauseFrames: 0
bcmQmxDot3OutPauseFrames: 0
bcmQmxIfHCInOctets: 511632
bcmQmxIfHCInUcastPkts: 0
bcmQmxIfHCInMulticastPkts: 5016
bcmQmxIfHCInBroadcastPkts: 0
bcmQmxIfHCOutOctets: 6236484
bcmQmxIfHCOutUcastPkts: 0
bcmQmxIfHCOutMulticastPkts: 62702
bcmQmxIfHCOutBroadcastPkts: 5790
bcmQmxIeee8021PfcRequests: 0
bcmQmxIeee8021PfcIndications: 0
bcmQmxBcmEtherStatsPkts1519to15220Octets: 0
bcmQmxBcmEtherStatsPkts1522to20470Octets: 0
bcmQmxBcmReceivedPkts64Octets: 0
bcmQmxBcmReceivedPkts65to127Octets: 5016
bcmQmxBcmReceivedPkts128to255Octets: 0
bcmQmxBcmReceivedPkts256to511Octets: 0
bcmQmxBcmReceivedPkts512to1023Octets: 0
bcmQmxBcmReceivedPkts1024to1518Octets: 0
bcmQmxBcmReceivedPkts1519to20470Octets: 0
bcmQmxBcmTransmittedPkts64Octets: 5790
bcmQmxBcmTransmittedPkts65to127Octets: 62678
bcmQmxBcmTransmittedPkts128to255Octets: 24
bcmQmxBcmTransmittedPkts256to511Octets: 0
bcmQmxBcmTransmittedPkts512to1023Octets: 0
bcmQmxBcmTransmittedPkts1024to1518Octets: 0
bcmQmxBcmTransmittedPkts1519to20470Octets: 0
bcmQmxBcmTransmittedPkts2048to4095Octets: 0
bcmQmxBcmTransmittedPkts4095to9216Octets: 0

```

Logical Interface: ifl-0/0/10/100, Physical Interface: ifp-0/0/10

Counter	Direction	Unit	Rx	Rx Diff	Rx Rate	Tx	Tx Diff	Tx Rate
IPv4	-	Packets	-	-	-	-	-	-

IPv6	-	Bytes	-	-	-	-	-	-	-
		Packets	-	-	-	-	-	-	-
MPLS	-	Bytes	-	-	-	-	-	-	-
		Packets	-	-	-	-	-	-	-
Punt	-	Bytes	-	-	-	-	-	-	-
		Packets	-	-	-	-	-	-	-
Miss	RX	Bytes	-	-	-	-	-	-	-
		Packets	-	-	-	-	-	-	-
Drops	-	Bytes	-	-	-	-	-	-	-
		Packets	4995	-	-	-	-	-	-
Error	RX	Bytes	-	-	-	-	-	-	-
		Packets	-	-	-	-	-	-	-
Error	TX	Bytes	-	-	-	-	-	-	-
		Packets	47	-	-	-	-	-	-
No Buff	RX	Bytes	-	-	-	-	-	-	-
		Packets	-	-	-	-	-	-	-
Traffic Statistics	-	Bytes	-	-	-	68492	-	-	-
		Packets	4995	-	-	-	-	-	-
Unicast Statistics	-	Bytes	-	-	-	5869876	-	-	-
		Packets	-	-	-	-	-	-	-
Broadcast Statistics	-	Bytes	-	-	-	-	-	-	-
		Packets	-	-	-	-	-	-	-
Multicast Statistics	-	Bytes	-	-	-	-	-	-	-
		Packets	-	-	-	-	-	-	-
		Bytes	-	-	-	-	-	-	-
		Packets	-	-	-	-	-	-	-
Packet Statistics:									
Ingress Forwarded Packets: 1810									
Ingress Forwarded Bytes: 184620									
Ingress Drop Packets: 1									
Ingress Drop Bytes: 102									
Egress Forwarded Packets: 0									
Egress Forwarded Bytes: 0									
Egress Drop Packets: 0									
Egress Drop Bytes: 0									
Logical Interface: ifl-0/0/10/200, Physical Interface: ifp-0/0/10									
Counter	Direction	Unit	Rx	Rx Diff	Rx Rate	Tx	Tx Diff	Tx Rate	
IPv4	-	Packets	-	-	-	-	-	-	-
		Bytes	-	-	-	-	-	-	-
IPv6	-	Packets	-	-	-	-	-	-	-
		Bytes	-	-	-	-	-	-	-
MPLS	-	Packets	-	-	-	-	-	-	-
		Bytes	-	-	-	-	-	-	-
Punt	-	Packets	-	-	-	-	-	-	-
		Bytes	-	-	-	-	-	-	-
Miss	RX	Packets	-	-	-	-	-	-	-
		Bytes	-	-	-	-	-	-	-
Drops	-	Packets	-	-	-	-	-	-	-
		Bytes	-	-	-	-	-	-	-
Error	RX	Packets	-	-	-	-	-	-	-
		Bytes	-	-	-	-	-	-	-
Error	TX	Packets	-	-	-	-	-	-	-
		Bytes	-	-	-	-	-	-	-
No Buff	RX	Packets	-	-	-	-	-	-	-
		Bytes	-	-	-	-	-	-	-
Traffic Statistics	-	Packets	-	-	-	6811	-	-	-
		Bytes	-	-	-	573170	-	-	-
Unicast Statistics	-	Packets	-	-	-	-	-	-	-
		Bytes	-	-	-	-	-	-	-
Broadcast Statistics	-	Packets	-	-	-	-	-	-	-
		Bytes	-	-	-	-	-	-	-
Multicast Statistics	-	Packets	-	-	-	-	-	-	-
		Bytes	-	-	-	-	-	-	-
Packet Statistics:									
Ingress Forwarded Packets: 0									
Ingress Forwarded Bytes: 0									
Ingress Drop Packets: 0									
Ingress Drop Bytes: 0									
Egress Forwarded Packets: 0									
Egress Forwarded Bytes: 0									
Egress Drop Packets: 0									
Egress Drop Bytes: 0									
Logical Interface: ifl-0/0/10/300, Physical Interface: ifp-0/0/10									
Counter	Direction	Unit	Rx	Rx Diff	Rx Rate	Tx	Tx Diff	Tx Rate	
IPv4	-	Packets	-	-	-	-	-	-	-
		Bytes	-	-	-	-	-	-	-
IPv6	-	Packets	-	-	-	-	-	-	-

MPLS	-	Bytes	-	-	-	-	-
		Packets	-	-	-	-	-
Punt	-	Bytes	-	-	-	-	-
		Packets	-	-	-	-	-
Miss	RX	Bytes	-	-	-	-	-
		Packets	-	-	-	-	-
Drops	-	Bytes	-	-	-	-	-
		Packets	-	-	-	-	-
Error	RX	Bytes	-	-	-	-	-
		Packets	-	-	-	-	-
Error	TX	Bytes	-	-	-	-	-
		Packets	-	-	-	-	-
No Buff	RX	Bytes	-	-	-	-	-
		Packets	-	-	-	-	-
Traffic Statistics	-	Bytes	-	-	-	5902	-
		Packets	-	-	-	-	-
Unicast Statistics	-	Bytes	-	-	-	531180	-
		Packets	-	-	-	-	-
Broadcast Statistics	-	Bytes	-	-	-	-	-
		Packets	-	-	-	-	-
Multicast Statistics	-	Bytes	-	-	-	-	-
		Packets	-	-	-	-	-
		Bytes	-	-	-	-	-
Packet Statistics:							
Ingress Forwarded Packets: 0							
Ingress Forwarded Bytes: 0							
Ingress Drop Packets: 0							
Ingress Drop Bytes: 0							
Egress Forwarded Packets: 0							
Egress Forwarded Bytes: 0							
Egress Drop Packets: 0							
Egress Drop Bytes: 0							

## Show Port Map Command

The `show port map` command displays information about a physical interface's mapping with ONL port IDs and optic port IDs.

Syntax:

### show port map

Example: Port mapping

```

supervisor@rtbrick>LEAF01: op> show port map
IFP-Name      Interface-Type  Port-ID  Onlp-Port-ID  Optic-Port-ID
cpu-0/0/0     cpu             0        -              -
ifp-0/0/0     ethernet        1        32             32
ifp-0/0/1     ethernet        2        33             33
ifp-0/0/2     ethernet        3        34             34
ifp-0/0/3     ethernet        4        35             35
ifp-0/1/1     ethernet        5        1              1
ifp-0/1/2     ethernet        9        2              2
ifp-0/1/3     ethernet        13       3              3
ifp-0/1/4     ethernet        17       4              4
ifp-0/1/5     ethernet        21       5              5
ifp-0/1/6     ethernet        25       6              6
ifp-0/1/7     ethernet        29       7              7
ifp-0/1/8     ethernet        33       8              8
ifp-0/1/9     ethernet        37       9              9
ifp-0/1/10    ethernet        41       10             10
    
```

```

ifp-0/1/11      ethernet      45      11      11
ifp-0/1/12      ethernet      49      12      12
<...>

```

## Interface Clear Commands

Clear commands allow to reset operational states.

### Interface Statistics

This command clears interface counters.

Syntax:

**clear interface statistics** <option>

Option	Description
-	Without any additional option, the command clears the counters for all interfaces.
<interface-name>	Clears the counters for the given interface.

### Clear Neighbor Interface

This command clears neighbor interface.

Syntax:

**clear neighbor** <interface-name>

Option	Description
<interface-name>	Clears the given interface.

Example:

```

supervisor@rtbrick.net: cfg> show neighbor
Instance      MAC Address      Interface      IP Address
Dynamic  Entry Time
default       7a:0e:db:c0:00:00  ifp-0/0/0/10  11.1.1.2
true  Fri May 10 11:00:53
default       7a:0e:db:c0:00:00  ifp-0/0/0/10
fe80::780e:db00:ac0:0      true  Fri May 10 11:00:09
ip2           7a:0e:db:c0:00:00  ifp-0/0/0/1   10.1.1.2
true  Fri May 10 11:02:09
ip2           7a:0e:db:c0:00:00  ifp-0/0/0/1   20.1.1.2

```

```

true      Fri May 10 11:00:53
ip2      11:22:33:44:55:66    ifp-0/0/0/1    25.1.1.1
false    Fri May 10 11:00:02
supervisor@rtbrick.net: cfg> clear neighbor interface ifp-0/0/0/1 ip-address
10.1.1.2
Success: cleared neighbors
supervisor@rtbrick.net: cfg> show neighbor
Instance          MAC Address      Interface        IP Address
Dynamic  Entry Time
default           7a:0e:db:c0:00:00  ifp-0/0/0/10    11.1.1.2
true      Fri May 10 11:00:53
default           7a:0e:db:c0:00:00  ifp-0/0/0/10
fe80::780e:db00:ac0:0      true      Fri May 10 11:00:09
ip2              7a:0e:db:c0:00:00  ifp-0/0/0/1     20.1.1.2
true      Fri May 10 11:00:53
ip2              11:22:33:44:55:66  ifp-0/0/0/1     25.1.1.1
false    Fri May 10 11:00:02
    
```

## 6.2. ARP/ND

### 6.2.1. ARP/ND Overview

RBFS allows you to set the timer information for ARP and ND routes. The timer information specifies how frequently a device sends messages to its neighbor. RBFS provides a logical interface with which you can configure timers for neighbor routers. These timers are essential for protocols such as ARP and ND.

RBFS supports timers for the following attributes:

#### Gratuitous ARP Interval

The Gratuitous ARP is sent as a broadcast by a node to communicate its IP address to MAC address mapping on the network. The GARP timer enables you to specify the interval time based on which GARP can be communicated.

#### Neighbor Probe Interval

RBFS allows you to configure the neighbor probe interval for the specified interface. This attribute is used to ensure that the neighbor is available or not.

#### Router Advertisement Interval

RBFS allows you to configure router advertisement interval. Router advertisement includes route information to show the network hosts that the router is operational. The router sends these messages periodically within a time range specified with minimum and maximum values. The Router Advertisement Interval timer applies only to IPv6.

## Neighbor Scan Interval

It specifies the time interval for neighbor router scanning. It scans the ARP table of a neighbor router to determine which IP addresses are active.

## ARP Throttle Interval

ARP throttling is a method of rate limiting of ARP packets and it safeguards the router by limiting too many ARP requests triggered by incoming traffic. RBFS allows you to configure the time interval for ARP throttling.

## Supported Platforms

Not all features are necessarily supported on each hardware platform. Refer to the *Platform Guide* for the features and the sub-features that are or are not supported by each platform.

## 6.2.2. ARP/ND Configuration

### Configuration Hierarchy

The diagram illustrates the Neighbor Timer configuration hierarchy.

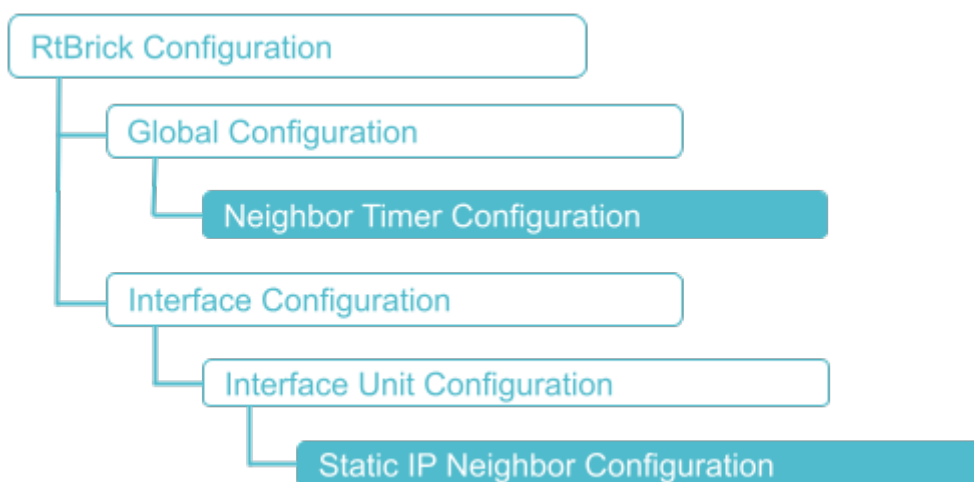

## Configuration Syntax and Commands

### Neighbor Timer Configuration

The following sections describe the interface configuration syntax and commands.

#### Syntax:

**set global neighbor** <attribute> <value>

Attribute	Description
garp-interval	Gratuitous ARP interval. The value is in seconds. Range: 1 to 1000 seconds Default: 60
probe-interval	Neighbor probe interval. The value is in seconds. Range: 1 to 1000 seconds Default: 10
ra-interval	Router advertisement interval. The value is in seconds. Range: 1 to 1000 seconds Default: 10
scan interval	Neighbor scan interval. The value is in seconds. Range: 1 to 1000 seconds Default: 60
throttle-interval	ARP throttle interval. The value is in seconds. Range: 1 to 1000 seconds Default: 10

## Example: Neighbor timer Configuration

```
{
  "rtbrick-config:neighbor": {
    "garp-interval": 10,
    "probe-interval": 120,
    "scan-interval": 120,
    "throttle-interval": 120,
    "ra-interval": 120
  }
}
```

**Static IP Neighbor Configuration**

This section describes configuration options at static IP neighbors.

**Syntax:**

**set interface** <interface-name> **unit** <unit-id> **neighbor** <attribute> <value>



Attribute	Description
<interface-name>	Name of the interface. Examples: ifp-0/0/1.
<unit-id>	Create a logical interface (also referred to as a sub-interface) under the physical interface.
IPv4/IPv6 <ip-address>	Neighbor IPv4 or IPv6 address.
MAC <mac-address>	Neighbor MAC address.

### Example: Static IP Neighbor Configuration

```

supervisor@rtbrick>LEAF01: cfg> show config
{
  "data": {
    "rtbrick-config:interface": [
      {
        "name": "ifp-0/1/5",
        "unit": [
          {
            "unit-id": 1,
            "neighbor": {
              "ipv4": [
                {
                  "address4": "198.51.100.10",
                  "mac": "11:11:11:11:11:11"
                }
              ]
            }
          }
        ]
      }
    ]
  }
}
    
```

### Enabling/Disabling GARP on Interface

You can enable or disable the sending of Gratuitous ARP (GARP) on an interface. This section describes enabling or disabling GARP on an interface.

#### Syntax:

**set interface** <interface-name> **unit** <unit-id> **gratituous-arp** <enable | disable>

Attribute	Description
interface <interface-name>	Name of the interface. Examples: ifp-0/0/1.

Attribute	Description
gratitous-arp	Specify enable or disable.

Example: Enabling Gratuitous ARP

```
supervisor@rtbrick.net: cfg> set interface hostif-0/0/0 unit 100 gratuitous-arp
enable|disable
```

## 6.2.3. ARP/ND Operational Commands

### Show Commands

#### Neighbor Timer Show Commands

Syntax:

**show neighbor** <option>

Option	Description
-	Without any option, the commands display the information for all neighbors.
instance <instance_name>	Displays summary of the specified neighbor instance
IPv4	Displays neighbor summary for the specified IPv4 address.
IPv6	Displays neighbor summary for the specified IPv6 address.
request <...>	Displays information about GARP requests made.

Example 1: Summary of neighbor

```
supervisor@rtbrick>LEAF01: op> show neighbor
Instance           MAC Address      Interface      IP Address      Dynamic  Entry
Time
default           e4:ed:7a:8e:d5:9d  if1-0/0/5/1   2001:db8:0:30::
true              Thu Feb 24 02:23:19
```

Example 2: Summary of neighbor instance

```
supervisor@rtbrick>LEAF01: op> show neighbor instance default
Instance           MAC Address      Interface      IP Address
```

```

Dynamic  Entry Time
default  7a:01:bf:60:03:02   ifp-0/2/3/10   2001:db8:0:111::
true    Thu Feb 24 04:57:22
default  7a:01:bf:60:03:02   ifp-0/2/3/20   2001:db8:0:19::
true    Thu Feb 24 04:57:22
    
```

### Example 3: Summary of the neighbor for the specified address family

```

supervisor@rtbrick>LEAF01: op> show neighbor ipv4
<cr>
instance          Instance name
    
```

```

supervisor@rtbrick>LEAF01: op> show neighbor ipv6
Instance          MAC Address      Interface      IP Address      Dynamic  Entry
Time
default          7a:01:bf:60:03:02   ifp-0/2/3/10   2001:db8:0:111::  true    Thu Feb 24
04:57:22
default          7a:01:bf:60:03:02   ifp-0/2/3/20   2001:db8:0:19::   true    Thu Feb 24
04:57:22
    
```

### Example 4: Summary of the static IP neighbor

```

supervisor@rtbrick>LEAF01: op> show neighbor
Instance          MAC Address      Interface      IP Address
Dynamic  Entry Time
default          11:11:11:11:11:11   if1-0/1/5/1    198.51.100.10
true    Fri Feb 25 10:13:04
    
```

## Neighbor Address Resolution

### Syntax:

**show address resolution** <request | response>

Option	Description
Request	Displays the summary of the address resolution request
Response	Displays the summary of address resolution response

### Example 1: Summary of the neighbor address resolution request

```

supervisor@rtbrick>LEAF01: op> show address-resolution request
TableName: global.static.1.address.resolution.request
Next Hop          AFI          SAFI          Instance
2001:db8:0:30::   ipv6         labeled-un    default
    
```

## Example 2: Summary of the neighbor address resolution response

```

supervisor@rtbrick>LEAF01: op> show address-resolution response
TableName: global.static.1.address.resolution.response
IP Address          Covering Prefix          MAC Address          Interface
2001:db8:0:30::    2001:db8:0:30::/32     e4:ed:7a:8e:d5:9d   if1-0/0/5/1
    
```

## Neighbor Request

This command is used to display detailed information about various ARP neighbor requests.

### Syntax:

**show neighbor request** <option>

Option	Description
-	Without any option, the commands display the information about all ARP requests made.
type	This option allows you to specify the type of neighbor request.
arp-proxy	Displays information about ARP proxy requests.
arp-reply	Shows ARP reply messages.
arp-request	Displays ARP request messages.
arp-static	Shows static ARP entries.
garp	Displays Gratuitous ARP (GARP) messages.

## Example 1: Summary of the request

```

supervisor@rtbrick: cfg> show neighbor request
Interface          IP Address          Type          Entry
Time
if1-0/1/10/0      192.168.25.1       garp          Thu
Aug 22 09:16:12
if1-0/1/61/10     63.1.1.1           garp          Thu
Aug 22 09:16:12
if1-0/1/61/10     63.1.1.2           arp-request   Thu
Aug 22 09:18:04
if1-0/1/61/10     63.1.1.2           arp-static    Thu
Aug 22 09:16:12
if1-0/1/10/0      fe80::e8c5:7a00:b2:4aa   garp          Thu
Aug 22 09:16:12
if1-0/1/61/10     fe80::e8c5:7aff:feb2:4dd   garp          Thu
    
```

Aug 22 09:16:12

## Example 2: Summary of the request type GARP

```

supervisor@rtbrick: cfg> show neighbor request type garp
Interface          IP Address          Type          Entry Time
ifl-0/1/10/0      192.168.25.1       garp          Thu Aug 22 09:16:12
ifl-0/1/61/10     63.1.1.1           garp          Thu Aug 22 09:16:12
ifl-0/1/10/0      fe80::e8c5:7a00:b2:4aa  garp          Thu Aug 22 09:16:12
ifl-0/1/61/10     fe80::e8c5:7aff:feb2:4dd  garp          Thu Aug 22 09:16:12
supervisor@rtbrick: cfg> show neighbor request type arp-static
Interface          IP Address          Type          Entry Time
ifl-0/1/61/10     63.1.1.2           arp-static    Thu Aug 22 09:16:12

```

## 6.3. ACLs

### 6.3.1. ACL Overview

#### ACL Use Cases

In RBFS, Access Control Lists (ACL) serve multiple purposes:

- Provide security by traffic filtering. This applies to both host and transit traffic. ACLs for traffic filtering are user-defined by configuration.
- Redirecting control traffic to the CPU. Such protocol ACLs also referred to as trap rules, are automatically created by the respective protocol, and do not need to be configured.
- Classifying traffic for differentiated QoS treatment. This is a special form of ACL referred to as a multi-field (MF) classifier. For more information about MF classifiers, please refer to the HQoS Configuration Guide.

#### ACL Components and Processing

User-defined ACLs consist of rules and ordinals. In case of multiple matching ACL rules, you can use priorities to define the result of the ACL.

- Rules - A rule is a named ACL entry that typically contains one or multiple match criteria and an action.
- Ordinals - An ordinal is solely a numbered configuration object. A rule can consist of multiple ordinals. Ordinals help to structure the configuration. In RBFS, it makes no difference if you configure one rule with multiple ordinals or

multiple rules with one ordinal each. Please note ordinals do not define the order of processing.

- Scope - ACLs generally apply globally. In particular, they are not applied to interfaces. You can, however configure an interface as a match criteria.
- Priorities - ACL entry priorities are used to define the processing of multiple matching ACL rules. In RBFS, by default, all ACL entries have the same priority, and there is no specific order. For example, if one ACL rule shall permit ICMP traffic from a specific prefix, and another rule shall deny any other ICMP traffic, it will by default result in a conflict as an ICMP packet matches both rules. To ensure that the more specific rule matches first, you can set its priority to higher. When the ACL priority value is set to a lower number, priority is higher.

## Prefix Lists

A prefix list is a named list of prefixes. Instead of listing multiple individual prefixes in a match rule of the ACL itself, you can reference a list that contains the prefixes, and thereby apply a common action to all matching prefixes. This helps to maintain lists and reuse them in multiple ACL rules.

Prefix lists can be used in ACL for permitting/denying traffic and in Multifield Classifier (MFC) for classifying traffic. This guide describes how to configure prefix lists and apply them in user-defined ACLs as firewall filters and apply prefix lists in MFC for traffic classification. For more information about applying prefix lists to MF classifiers, please refer to the *HQoS configuration Guide*.

When a prefix list is configured and referenced in an ACL, it is internally first added to an intermediate ACL configuration table. For each prefix, one separate rule is added to the final ACL configuration table. This is different from a prefix match in the ACL rule itself that is directly added to the ACL configuration table. A dedicated range of ordinals (200001-4294967295) is reserved to expand ACL rules when using prefix lists. If configured, the priority will be copied from the prefix list ACL configuration to all the expanded ACL rules.

When using prefix lists, the following restrictions apply:

- You cannot configure the same prefix-list name to match the source prefix list and destination prefix list.
- You cannot configure both the source prefix and source prefix list on the same ACL configuration.

- You cannot configure both the destination prefix and destination prefix list on the same ACL configuration.

## Supported Platforms

Not all features are necessarily supported on each hardware platform. Refer to the *Platform Guide* for the features and the sub-features that are or are not supported by each platform.

### 6.3.2. ACL Configuration

For configuring an access control list, you define filter criteria (with match conditions) for the packets and an action for the device to take if the packets match the filtering criteria.

#### Configuration Hierarchy

The diagram illustrates the ACL configuration hierarchy.

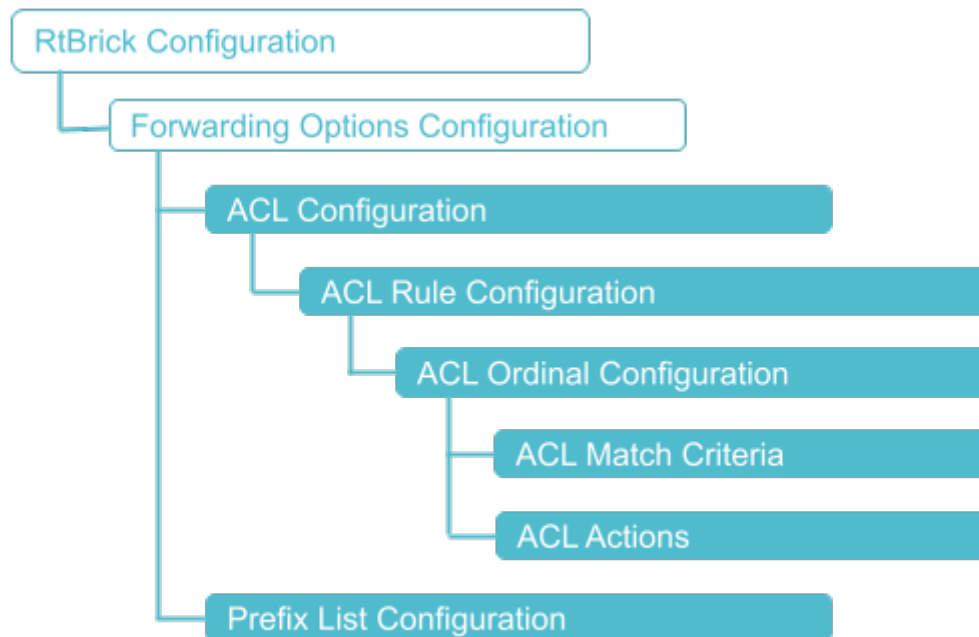

#### Configuration Syntax and Commands

The following sections describe the ACL configuration syntax and commands.

## Configuring ACLs

### Syntax:

**set forwarding-options acl** [**I2** | **I3v4** | **I3v6**] **rule** <name> **ordinal** <number>  
 <option> <attribute> <value>

Options	Description
<name>	Name of the ACL rule.
<number>	Specifies the ordinal number.
match <...>	Match configuration hierarchy. Please refer to section 2.2.1.1 for the ACL match criteria configuration.
action <...>	Action configuration hierarchy. Please refer to section 2.2.1.2 for the ACL actions configuration.
priority <priority>	Specifies the ACL priority value. The default entry priority for user-defined ACLs changes to 500. The configurable ACL entry priority range becomes 100 - 20000. A lower number indicates higher priority.

### Configuring ACL Match Criteria

**set forwarding-options acl** [ **I2** | **I3v4** | **I3v6** ] **rule** <rulename> **ordinal**  
 <ordinal\_value> **match** <attribute> <value>

Attribute	Description
destination-mac <destination-mac>	ACL L2 destination mac match.
destination-ipv4-prefix <destination-ipv4-prefix>	ACL L3 IPv4 destination prefix match.
destination-ipv4-prefix-list <destination-ipv4-prefix-list>	ACL destination IPv4 prefix-list name. You can apply a prefix list that is previously configured. Refer to section <a href="#">Configuring Prefix Lists</a> .
destination-l4-port <destination-l4-port>	ACL L4 destination port match.



Attribute	Description
destination-ipv4-local true	Indicates whether match support is enabled for all traffic destined for the routers' IP addresses. <b>Note:</b> To disable the configuration, use the <b>delete</b> form of the command.
destination-ipv6-prefix <destination-ipv6-prefix>	ACL L3 IPv6 destination prefix match.
destination-ipv6-prefix-list <destination-ipv6-prefix-list>	ACL destination IPv6 prefix-list name. You can apply a prefix list that is previously configured. Refer to section <a href="#">Configuring Prefix Lists</a> .
destination-ipv6-local true	Indicates whether match support is enabled for all traffic destined for the routers' IP addresses. To disable the configuration, use the <b>delete</b> form of the command.
direction ingress	ACL L2/L3 direction match. Currently, only the ingress direction is supported.
ethertype <ethertype>	ACL L2 EtherType match.
inner-tag-protocol-id <inner-tag-protocol-id>	ACL L2 inner TPID match.
inner-vlan <inner-vlan>	ACL L2 inner-VLAN match.
inner-vlan-cfi <inner-vlan-cfi>	ACL L2 inner-VLAN CFI match.
inner-vlan-priority <inner-vlan-priority>	ACL L2 inner-VLAN priority match.
interface <interface>	Interface match.
ip-options true	Match if the IPv4 packet has options. Supported value: true.
ip-protocol <protocol>	ACL IP protocol value match such as TCP, UDP, ICMP.
ipv4-dscp <ipv4-dscp>	IPv4 DSCP value.
ipv4-tos <ipv4-tos>	IPv4 ToS value.
ipv6-tc <ipv6-tc>	Codepoint class value.
logical-interface <logical-interface>	Logical interface match.

Attribute	Description
source-ipv4-prefix <source-ipv4-prefix>	ACL L3 IPv4 source prefix match.
source-ipv4-prefix-list <source-ipv4-prefix-list>	ACL source IPv4 prefix-list name. You can apply a prefix list that is previously configured. Refer to section <a href="#">Configuring Prefix Lists</a> .
source-ipv6-prefix <source-ipv6-prefix>	Configure ACL L3 IPv6 source prefix match.
source-ipv6-prefix-list <source-ipv6-prefix-list>	ACL source IPv6 prefix-list name. You can apply a prefix list that is previously configured. Refer to section <a href="#">Configuring Prefix Lists</a> .
source-l4-port <source-l4-port>	ACL L4 source port match.
outer-tag-protocol-id <outer-tag-protocol-id>	ACL L2 outer TPID match.
outer-vlan <outer-vlan>	ACL L2 outer-VLAN match.
outer-vlan-cfi <outer-vlan-cfi>	ACL L2 outer VLAN CFI match.
outer-vlan-priority <outer-vlan-priority>	ACL L2 outer VLAN priority match.
source-mac <source-mac>	ACL L2 source MAC match.
traffic-class <class>	Forward class value. Supported values: class-0 to class-7, class-all.
ttl <tll>	IPv4 time-to-live value.
match-mpls-traffic true	Match single MPLS label termination. To disable, use the <a href="#">delete</a> form of the command.

### Example 1: Layer 2 Match Configuration

```

{
  "rtbrick-config:acl": {
    "12": {
      "rule": [
        {
          "rule-name": "a10nsp-drop-lag-2",
          "ordinal": [
            {
              "ordinal-value": 1,
            }
          ]
        }
      ]
    }
  }
}
    
```

```

    "match": {
      "direction": "ingress",
      "interface": "lag-2",
      "outer-vlan-priority": 1
    },
    "action": {
      "drop": "true",
      "statistics": "true"
    }
  },

```

## Example 2: Layer 3 IPv4 Match Configuration

```

{
  "rtbrick-config:acl": {
    "l3v4": {
      "rule": [
        {
          "rule-name": "rtb_firewall_two",
          "ordinal": [
            {
              "ordinal-value": 1000,
              "match": {
                "direction": "ingress",
                "source-ipv4-prefix": "198.51.100.50/24",
                "source-l4-port": 8080
              },
              "action": {
                "drop": "true"
              }
            }
          ]
        },
        {
          "rule-name": "rule2",
          "ordinal": [
            {
              "ordinal-value": 5,
              "match": {
                "direction": "ingress",
                "interface": "ifp-0/0/1"
              }
            }
          ]
        }
      ]
    }
  }
}

```

## Example 3: Layer 3 IPv6 Match Configuration

```

{
  "rtbrick-config:l3v6": {
    "rule": [
      {

```

```

    "rule-name": "rtb_firewall_two",
    "ordinal": [
      {
        "ordinal-value": 1000,
        "match": {
          "direction": "ingress",
          "source-ipv6-prefix": "2001:db8:0:11::/32",
          "source-l4-port": 8080
        },
        "action": {
          "permit": "true"
        }
      }
    ]
  }
}

```

Example 4: Match support for all traffic destined for any of the router's IP addresses

```

{
  "rtbrick-config:acl": {
    "l3v4": {
      "rule": [
        {
          "rule-name": "rule4",
          "ordinal": [
            {
              "ordinal-value": 4,
              "match": {
                "direction": "ingress",
                "destination-ipv4-local": "true"
              },
              "action": {
                "drop": "true"
              }
            }
          ]
        }
      ]
    },
    "l3v6": {
      "rule": [
        {
          "rule-name": "rule2",
          "ordinal": [
            {
              "ordinal-value": 2,
              "match": {
                "direction": "ingress",
                "destination-ipv6-local": "true"
              },
              "action": {
                "drop": "true"
              }
            }
          ]
        }
      ]
    }
  }
}

```

```



    ]
  }
}
}
}
}
}

```

## Configuring ACL Actions

### Syntax:

**set forwarding-options acl** [**I3v4** | **I3v6**] **rule** <rulename> **ordinal** <ordinal\_value> **action** <attribute> <value>

Attribute	Description
drop true	If the ACL rule specifies <b>drop true</b> , the system will discard any packets that match that rule. Use the <b>delete</b> form of the command for the system to ignore the rule.
permit true	If the ACL rule specifies <b>permit true</b> , the system forwards traffic matching that rule. Use the <b>delete</b> form of the command for the system to ignore the rule.
action statistics true	Configure action, enable statistics. Use the <b>delete</b> form of the command to disable the configuration. <div style="display: flex; align-items: center; margin-top: 10px;"> <div style="margin-right: 10px;"></div> <div>A limited number of counter resources are available in a common pool for user-defined ACLs, protocol ACLs, L3, and L2X logical interfaces.</div> </div>
forward-class <class>	Specifies forward class value (class-0 to class-7, class-all)
mirror <mirror>	Specifies ACL action mirror name. <div style="display: flex; align-items: center; margin-top: 10px;"> <div style="margin-right: 10px;"></div> <div>Currently, ACLs with mirror actions are not supported.</div> </div>

Attribute	Description
capture true	You can enable the capture action when using the RBFS built-in capture feature with an ACL to more granularly specify the traffic to be captured. To disable, use the <b>delete</b> form of the command. For more information and an example, refer to the <i>RBFS NOC Troubleshooting Guide</i> .
policer-name <policer-name>	Specifies policer profile name.
redirect-to-cpu true	Configure action, redirect packets to CPU. To disable, use the <b>delete</b> form of the command.

## Example

```
{
  "rule-name": "rtb_firewall_two",
  "ordinal": [
    {
      "ordinal-value": 1000,
      "match": {
        "direction": "ingress",
        "source-ipv4-prefix": "198.51.100.50/24",
        "source-l4-port": 8080
      },
      "action": {
        "drop": "true"
      }
    }
  ]
}
```

## Configuring Prefix Lists

### Configuring IPv4/IPv6 Prefix List for ACL and Multifield Classifier

#### Syntax:

**set forwarding-options prefix-list** <prefix-list-name> <attribute> <value>

Attribute	Description
<prefix-list-name>	Name of the prefix list, which will be later used to attach with ACL configuration.
ipv4-prefix <ipv4_prefix>	Specifies the IPv4 prefix address.

Attribute	Description
ipv6-prefix <ipv6_prefix>	Specifies the IPv6 prefix address.

## Example 1: Prefix List Configuration

```

supervisor@rtbrick>LEAF01: op> show config forwarding-options prefix-list
{
  "rtbrick-config:prefix-list": [
    {
      "prefix-list-name": "ipv4-list",
      "ipv4-prefix": [
        {
          "ipv4-prefix": "198.51.100.50/24"
        },
        {
          "ipv4-prefix": "198.51.101.60/24"
        },
        {
          "ipv4-prefix": "198.51.102.70/24"
        }
      ]
    }
  ]
}

```

## Example 2: Using Prefix-list in Multifield-Classfier

```

supervisor@rtbrick>LEAF01: op> show config forwarding-options prefix-list pta-
iptv-multicast
{
  "rtbrick-config:prefix-list": [
    {
      "prefix-list-name": "ipv4-list",
      "ipv4-prefix": [
        {
          "ipv4-prefix": "198.51.100.50/24"
        },
        {
          "ipv4-prefix": "198.51.101.60/24"
        },
        {
          "ipv4-prefix": "198.51.102.70/24"
        }
      ]
    }
  ]
}

```

## Example 3: Viewing Multifield-Classfier Details

```

supervisor@rtbrick>LEAF01: op> show config forwarding-options class-of-service

```

```

multifield-classifier acl 13v4 rule pta-triple-play-8queues ordinal 6000
{
  "rtbrick-config:ordinal": [
    {
      "ordinal-value": 6000,
      "match": {
        "destination-ipv4-prefix-list": "ipv4-list"
      },
      "action": {
        "forward-class": "class-1",
        "remark-codepoint": 248
      }
    }
  ]
}

```

### 6.3.3. ACL Operational Commands

#### ACL Show Commands

**Syntax:**

**show acl** <option>

Option	Description
-	Without any option, this command displays brief information about the access control list (ACL).
detail	Displays detailed information about the access-control list (ACL).
type <acl_type>	Displays detailed information for the specified ACL type.
rule <acl-rule-name>	Displays detailed information for the specified ACL rule name.
ordinal <ordinal>	Displays detailed information for the specified Ordinal
type <acl_type> rule <rule_name>	Displays detailed information for the specified ACL Type and Rule name
type <acl_type> ordinal <ordinal>	Displays detailed information for the specified ACL Type and Ordinal
rule <rule_name> type <acl_type>	Displays detailed information for the specified ACL Type and Rule name



Option	Description
rule <rule_name> ordinal <ordinal>	Displays detailed information for the specified Rule name and Ordinal
ordinal <ordinal> type <acl_type>	Displays detailed information for the specified ACL Type and Ordinal
ordinal <ordinal> rule <rule_name>	Displays detailed information for the specified Rule name and Ordinal
type <acl_type> rule <rule_name> ordinal <ordinal>	Displays detailed information for the specified Ordinal, ACL Type and Rule name
type <acl_type> ordinal <ordinal> rule <rule_name>	Displays detailed information for the specified Ordinal, ACL Type and Rule name
rule <rule_name> ordinal <ordinal> type <acl_type>	Displays detailed information for the specified Ordinal, ACL Type and Rule name
rule <rule_name> type <acl_type> ordinal <ordinal>	Displays detailed information for the specified Ordinal, ACL Type and Rule name
ordinal <ordinal> rule <rule_name> type <acl_type>	Displays detailed information for the specified Ordinal, ACL Type and Rule name
ordinal <ordinal> type <acl_type> rule <rule_name>	Displays detailed information for the specified Ordinal, ACL Type and Rule name

### Example 1: Show information about ACLs

```

supervisor@rtbrick>LEAF01: op> show acl
ACL                Ordinal    Type      Attach Point
rule4              4          13v4     -
                  8          13v4     -
lldp.ifp-0/0/0.trap.rule -          12      ifp-0/0/0
lldp.ifp-0/1/0.trap.rule -          12      ifp-0/1/0
lldp.ifp-0/1/1.trap.rule -          12      ifp-0/1/1
lldp.ifp-0/1/4.trap.rule -          12      ifp-0/1/4
lldp.ifp-0/1/5.trap.rule -          12      ifp-0/1/5
lldp.ifp-0/1/6.trap.rule -          12      ifp-0/1/6
lldp.ifp-0/1/12.trap.rule -         12      ifp-0/1/12
lldp.ifp-0/1/13.trap.rule -         12      ifp-0/1/13
lldp.ifp-0/1/22.trap.rule -         12      ifp-0/1/22
    
```

lldp.ifp-0/1/23.trap.rule - 12 ifp-0/1/23

## Example 2: Show detailed information about ACLs

```

supervisor@rtbrick>LEAF01: op> show acl detail
Rule: rule4
  ACL type: l3v4
  Ordinal: 4
  Match:
    Direction: ingress
    Source IPv4 prefix: 198.51.100.35/24
  Action:
    Drop: True
  Result:
    Trap ID: User Defined
  Statistics:
    Units      Total      Accepted   Dropped
    Packets    4          0          4
    Bytes      424        0          424
Ordinal: 8
  Match:
    Direction: ingress
    Source IPv4 prefix: 198.51.100.45/24
  Action:
    Drop: True
  Result:
    Trap ID: User Defined
  Statistics:
    Units      Total      Accepted   Dropped
    Packets    9          0          9
    Bytes      990        0          990
Rule: lldp.ifp-0/0/0.trap.rule
  ACL type: l2
  Ordinal: -
  Match:
    Attachment point: ifp-0/0/0
    Direction: ingress
    Destination MAC: 01:80:c2:00:00:0e
  Action:
    Redirect to CPU: True
  Result:
    Trap ID: LLDP
  Statistics:
    Units      Total      Accepted   Dropped
    Packets    105        105        0
    Bytes      12915      12915     0
Rule: lldp.ifp-0/1/0.trap.rule
  ACL type: l2
  Ordinal: -
  Match:
    Attachment point: ifp-0/1/0
    Direction: ingress
    Destination MAC: 01:80:c2:00:00:0e
  Action:
    Redirect to CPU: True
  Result:
    Trap ID: LLDP
  Statistics:
    Units      Total      Accepted   Dropped

```

Packets	220	220	0
Bytes	19140	19140	0

### Example 3: Show detailed information for a specified ACL Rule

```

supervisor@rtbrick>LEAF01: op> show acl rule4
Rule: rule4
  ACL type: l3v4
  Ordinal: 4
  Match:
    Direction: ingress
    Source IPv4 prefix: 198.51.100.35/24
  Action:
    Drop: True
  Result:
    Trap ID: User Defined
  Statistics:
    Units      Total      Accepted   Dropped
    Packets    4         0         4
    Bytes     424      0         424
Ordinal: 8
  Match:
    Direction: ingress
    Source IPv4 prefix: 198.51.100.45/24
  Action:
    Drop: True
  Result:
    Trap ID: User Defined
  Statistics:
    Units      Total      Accepted   Dropped
    Packets    9         0         9
    Bytes     990      0         990
    
```

## ACL Statistics Commands



ACL statistics are currently not supported for PIM, IGMP, and L2TP protocol traffic.

### Syntax:

**show acl** <option> **statistics**

Option	Description
statistics	Displays ACL statistics information
<acl-name> statistics	Displays ACL statistics information for the specified ACL
type <acl_type> statistics	Displays ACL statistics information for the specified ACL type

Option	Description
rule <rule_name> statistics	Displays ACL statistics information for the specified rule name
ordinal <ordinal> statistics	Displays ACL statistics information for the specified ordinal
type <acl_type> rule <rule_name> statistics	Displays ACL statistics information for the specified ACL type and rule name
type <acl_type> ordinal <ordinal> statistics	Displays ACL statistics information for the specified ACL type and ordinal
rule <rule_name> type <acl_type> statistics	Displays ACL statistics information for the specified ACL type and rule name
rule <rule_name> ordinal <ordinal> statistics	Displays ACL statistics information for the specified rule name and ordinal
ordinal <ordinal> type <acl_type> statistics	Displays ACL statistics information for the specified ACL type and ordinal
ordinal <ordinal> rule <rule_name> statistics	Displays ACL statistics information for the specified rule name and ordinal
<acl_type> rule <rule_name> ordinal <ordinal> statistics	Displays ACL statistics information for the specified ordinal, ACL type and rule name
type <acl_type> ordinal <ordinal> rule <rule_name> statistics	Displays ACL statistics information for the specified ordinal, ACL type and rule name
rule <rule_name> ordinal <ordinal> type <acl_type> statistics	Displays ACL statistics information for the specified ordinal, ACL type and rule name
rule <rule_name> type <acl_type> ordinal <ordinal> statistics	Displays ACL statistics information for the specified ordinal, ACL type and rule name
ordinal <ordinal> rule <rule_name> type <acl_type> statistics	Displays ACL statistics information for the specified ordinal, ACL type and rule name

Option	Description
ordinal <ordinal> type <acl_type> rule <rule_name> statistics	Displays ACL statistics information for the specified ordinal, ACL type and rule name

### Example 1: Display ACL statistics information

```

supervisor@rtbrick>LEAF01: op> show acl statistics
ACL                Units      Total      Accepted   Dropped
rule4              Packets    4          0          4
                  Bytes     424        0          424
rule4              Packets    9          0          9
                  Bytes     990        0          990
lldp.ifp-0/0/0.trap.rule Packets    107        107         0
                  Bytes    13161     13161         0
lldp.ifp-0/1/0.trap.rule Packets    221        221         0
                  Bytes    19227     19227         0
lldp.ifp-0/1/1.trap.rule Packets    221        221         0
                  Bytes    19227     19227         0
lldp.ifp-0/1/4.trap.rule Packets    214        214         0
                  Bytes    31672     31672         0
lldp.ifp-0/1/5.trap.rule Packets    214        214         0
                  Bytes    31672     31672         0
lldp.ifp-0/1/6.trap.rule Packets    214        214         0
                  Bytes    31672     31672         0
lldp.ifp-0/1/12.trap.rule Packets    107        107         0
                  Bytes    13375     13375         0
lldp.ifp-0/1/13.trap.rule Packets    107        107         0
                  Bytes    13375     13375         0
lldp.ifp-0/1/22.trap.rule Packets    107        107         0
                  Bytes    13375     13375         0
lldp.ifp-0/1/23.trap.rule Packets    107        107         0
                  Bytes    13375     13375         0
    
```

### Example 2: Display ACL statistics information for the specified ACL

```

supervisor@rtbrick>LEAF01: op> show acl rule4 statistics
ACL      Units      Total      Accepted   Dropped
rule4    Packets    4          0          4
        Bytes     424        0          424
rule4    Packets    9          0          9
        Bytes     990        0          990
    
```

## ACL Clear Commands

Clear commands allow resetting operational states.

## Clear ACL Statistics

### Syntax:

**clear acl** <options>

Option	Description
statistics	Clears all the ACL statistics.
type <acl_type> statistics	Clears all ACL statistics for the specified ACL type
rule <rule_name> statistics	Clears all ACL statistics for the specified rule
ordinal <ordinal> statistics	Clears all ACL statistics for the specified ordinal
type <acl_type> rule <rule_name> statistics	Clears all ACL statistics for the specified ACL type and rule
type <acl_type> ordinal <ordinal> statistics	Clears all ACL statistics for the specified ACL type and ordinal
rule <rule_name> type <acl_type> statistics	Clears all ACL statistics for the specified ACL type and rule
rule <rule_name> ordinal <ordinal> statistics	Clears all ACL statistics for the specified rule and ordinal
ordinal <ordinal> type <acl_type> statistics	Clears all ACL statistics for the specified ACL Type and Ordinal
ordinal <ordinal> rule <rule_name> statistics	Clears all ACL statistics for the specified Rule name and Ordinal
type <acl_type> rule <rule_name> ordinal <ordinal> statistics	Clears all ACL statistics for the specified Ordinal, ACL Type and Rule name
type <acl_type> ordinal <ordinal> rule <rule_name> statistics	Clears all ACL statistics for the specified Ordinal, ACL Type and Rule name
rule <rule_name> ordinal <ordinal> type <acl_type> statistics	Clears all ACL statistics for the specified Ordinal, ACL Type and Rule name

Option	Description
rule <rule_name> type <acl_type> ordinal <ordinal> statistics	Clears all ACL statistics for the specified Ordinal, ACL Type and Rule name
ordinal <ordinal> rule <rule_name> type <acl_type> statistics	Clears all ACL statistics for the specified Ordinal, ACL Type and Rule name
ordinal <ordinal> type <acl_type> rule <rule_name> statistics	Clears all ACL statistics for the specified Ordinal, ACL Type and Rule name

Example: Clearing ACL Statistics of a specified ACL Rule

```
supervisor@rtbrick>LEAF01: op> clear acl rule lldp.ifp-0/0/44.trap.rule statistics
Success : command success
supervisor@rtbrick>LEAF01: op>
```

## 6.4. Port Mirroring

### 6.4.1. Port Mirroring Overview

Port Mirroring is a method of monitoring network traffic. When you enable port mirroring, the switch sends a copy of all network packets seen on one port to another port, where the packet can be analyzed.

#### Inbound Mirroring

Inbound mirroring is defined per In-Port, or per In-Port x VLAN. Configurations for six distinct VLAN tags, for any other VLAN tag, and for packets without VLAN tags are supported. The ingress mirroring can be sampled by specifying a probability that a matching packet will be mirrored.

#### Outbound Mirroring

Outbound mirroring is defined per Out-Port, or per Out-Port x VLAN tag. Configurations for seven distinct VLAN tags are supported.

## Guidelines and Limitations

- Up to 15 mirror profiles can be configured.
- The same mirror resources are used for Lawful Interception (LI) and Port Mirroring.
- You can configure a CPU port as destination physical interface port; but if heavy traffic is mirrored, it may impact system performance.
- If physical interface/logical interface goes down, mirror configuration will not be deleted automatically. You need to delete the mirror configuration explicitly.
- Before creating logical interface mirroring, the source logical interface should exist.
- The logical interface should not be deleted during mirroring.
- If you want to mirror traffic to CPU, enable the control plane security features. For more refer, see the *Control Plane Security Guide*.
- Since this is a debugging tool, the save and reload functionality is not supported.

## Supported Platforms

Not all features are necessarily supported on each hardware platform. Refer to the *Platform Guide* for the features and the sub-features that are or are not supported by each platform.

### 6.4.2. Port Mirroring Configuration

#### Configuration Hierarchy

The diagram illustrates the port mirroring configuration hierarchy.





## Configuration Syntax and Commands

The following sections describe the port mirroring configuration syntax and commands.

### Syntax:

**set forwarding-options mirror** <name> [**source** | **destination**] <attribute> <value>

Attribute	Value
<name>	Name for mirror configuration
acl true	Configure source as ACL. Note: Use <b>delete</b> form of the command to disable the configuration.
direction [egress   ingress]	Configure traffic direction ingress/egress.
interface <interface>	Specifies the physical interface name.
logical-interface <logical-interface>	Configure source logical interface name.

### Example 1: Mirroring one physical interface traffic to another physical interface

```
{
  "rtbrick-config:mirror": [
    {
      "name": "MIRROR1",
      "destination": {
        "interface": "ifp-0/0/4"
      },
      "source": {
        "direction": "ingress",
        "interface": "ifp-0/0/2"
      }
    }
  ]
}
```

### Example 2: Mirroring Traffic to CPU

```
{
  "rtbrick-config:mirror": [
    {
      "name": "mirror1",
```

```

    "destination": {
      "interface": "cpu-0/0/200"
    },
    "source": {
      "direction": "ingress",
      "interface": "ifp-0/0/52"
    }
  ]
}

```

### 6.4.3. Port Mirroring Operational Commands

#### Capturing Mirror Traffic

After you configure mirroring to CPU by using the commands above, you can use the **capture** command to capture the mirror traffic.

**Syntax:**

**capture mirror file** <file\_name> [**start** | **stop**]

Attribute	Value
<file_name>	Name of the file where mirror traffic is captured

Example 1: Starting and stopping mirror traffic to a file

```

root@rtbrick: cfg> capture mirror file test.pcap start
root@rtbrick: cfg> capture mirror file test.pcap stop

```

#### Show Commands

**show capture sessions**

**Syntax:**

**show capture sessions**

Option	Description
-	Without any option, the commands displays the FIB packet Capture sessions.

Example 1: Summary of FIB packet Capture sessions

```
supervisor@rtbrick: op> show capture sessions
Interface          Direction  File          Context
ifp-0/0/1          BOTH      -             45
```

## 6.5. OAM Support

### 6.5.1. OAM Overview

Operations, Administration and Management (OAM) are the processes, activities, tools, and standards involved with performing operational, administrative, and management tasks. RBFS provides the following OAM features that enable you troubleshoot RtBrick software:

- IP ping
- IP traceroute
- IP ping on an MPLS transport
- IP traceroute on an MPLS transport

MPLS ping and traceroute will be supported in the later releases

### Supported Platforms

Not all features are necessarily supported on each hardware platform. Refer to the *Platform Guide* for the features and the sub-features that are or are not supported by each platform.

### 6.5.2. OAM Configuration

#### Guidelines

- Execute the OAM commands in the **operation** mode of the CLI.

```
admin@rtbrick:~$ cli
admin@rtbrick: cfg> switch-mode operation
Activating syntax mode : op [operation]
admin@rtbrick: op>
```

## IP Ping

The IP ping utility is used to check the reachability of an IP address.

### IP ping in default instance

The **ping** command allows you to ping to a destination to see if a networked device is reachable.

### Syntax

```
ping <destination-ip> [source-interface <interface>] count <count> interval  
<interval> size <size> source-ip <source-ip> ttl <ttl> tos <tos>
```

### Command Parameters

<b>destination-ip</b>	<b>ipv4 destination address</b>
interface	source interface
count	count of the ping packet (default 5)
do-not-fragment	set the do-not-fragment (DF) bit in IP header
interval	interval between the packets (default 1 sec)
size	size of the ping packet (default 60)
source-ip	IPv4 source address
ttl	Time-to-live to be used in the packet
tos	Type of Service (TOS) to be used in the packet

### Example

```
admin@rtbrick: op> ping 198.51.100.111  
68 bytes from 198.51.100.111: icmp_seq=1 ttl=64 time=11.8707 ms  
68 bytes from 198.51.100.111: icmp_seq=2 ttl=64 time=1.9824 ms  
68 bytes from 198.51.100.111: icmp_seq=3 ttl=64 time=5.0726 ms  
68 bytes from 198.51.100.111: icmp_seq=4 ttl=64 time=5.6529 ms  
68 bytes from 198.51.100.111: icmp_seq=5 ttl=64 time=10.6588 ms  
Statistics: 5 sent, 5 received, 0% packet loss
```

### IP ping in specific instance and afi/safi

This command allows you to ping to a destination in a particular VRF.

## Syntax

```
ping <destination-ip> [instance <instance-name> afi <afi> safi<safi>] [source-
interface <interface>] count <count> interval <interval> size <size> source-ip
<source-ip> ttl <ttl> tos <tos>
```

## Command Parameters

destination-ip	ipv4 destination address
instance-name	instance on which ping has to be executed
afi	IPv4 Address Family Identifier (AFI)
safi	Subsequent address family identifier (SAFI)
interface	source interface
count	count of the ping packet (default 5)
do-not-fragment	set the do-not-fragment (DF) bit in IP header
interval	interval between the packets (default 1 sec)
size	size of the ping packet (default 60)
source-ip	IPv4 source address
ttl	Time-to-live to be used in the packet
tos	Type of Service (TOS) to be used in the packet



The afi/safi attributes are optional; if not specified, afi would be ipv4 and safi would be unicast.

## Example

```
admin@rtbrick: op> ping 198.51.100.80 instance ip2vrf afi ipv4 safi labeled-
unicast
68 bytes from 198.51.100.80: icmp_seq=1 ttl=64 time=18.1306 ms
68 bytes from 198.51.100.80: icmp_seq=2 ttl=64 time=32.1058 ms
68 bytes from 198.51.100.80: icmp_seq=3 ttl=64 time=19.8205 ms
68 bytes from 198.51.100.80: icmp_seq=4 ttl=64 time=20.0144 ms
68 bytes from 198.51.100.80: icmp_seq=5 ttl=64 time=32.0085 ms
Statistics: 5 sent, 5 received, 0% packet loss
```

## IPv6 Ping

The IPv6 ping utility is used to check the reachability of an IPv6 address.

## IPv6 ping in default instance

The **ping** command allows you to ping to an IPv6 destination to see if a networked device is reachable.

### Syntax

```
ping <destination-ipv6> [source-interface <interface>] count <count> interval
<interval> size <size> source-ip <source-ipv6> ttl <ttl> tos <tos>
```

### Command Parameters

destination-ipv6	ipv6 destination address
interface	source interface
count	count of the ping packet (default 5)
do-not-fragment	set the do-not-fragment (DF) bit in IP header
interval	interval between the packets (default 1 sec)
size	size of the ping packet (default 60)
source-ipv6	IPv6 source address
ttl	Time-to-live to be used in the packet
tos	Type of Service (TOS) to be used in the packet

### Example

```
admin@rtbrick: op> ping 2001:db8:0:42::
68 bytes from 2001:db8:0:42::: icmp_seq=1 ttl=64 time=.0503 ms
68 bytes from 2001:db8:0:42::: icmp_seq=2 ttl=64 time=.0321 ms
68 bytes from 2001:db8:0:42::: icmp_seq=3 ttl=64 time=.0314 ms
68 bytes from 2001:db8:0:42::: icmp_seq=4 ttl=64 time=.0325 ms
68 bytes from 2001:db8:0:42::: icmp_seq=5 ttl=64 time=.0354 ms
Statistics: 5 sent, 5 received, 0% packet loss
```

## IPv6 ping in specific instance and afi/safi

This command allows you to ping to an IPv6 destination in a particular VRF.

### Syntax

```
ping <destination-ipv6> [instance <instance-name> afi<afi> safi<safi>] [source-
```

```
interface <interface>] count <count> interval <interval> size <size> source-ip
<source-ipv6> ttl <ttl> tos <tos>
```

## Command Parameters

destination-ipv6	ipv6 destination address
instance-name	instance on which ping has to be executed
afi	IPv4 Address Family Identifier (AFI)
safi	Subsequent address family identifier (SAFI)
interface	source interface
count	count of the ping packet (default 5)
do-not-fragment	set the do-not-fragment (DF) bit in IP header
interval	interval between the packets (default 1 sec)
size	size of the ping packet (default 60)
source-ipv6	IPv6 source address
ttl	Time-to-live to be used in the packet
tos	Type of Service (TOS) to be used in the packet



The afi/safi attributes are optional; if not specified, afi would be ipv6 and safi would be unicast.

## Example

```
admin@rtbrick: op> ping 2001:db8:0:42:: instance abc afi ipv6 safi labeled-unicast
68 bytes from 2001:db8:0:42:: icmp_seq=1 ttl=64 time=.0503 ms
68 bytes from 2001:db8:0:42:: icmp_seq=2 ttl=64 time=.0321 ms
68 bytes from 2001:db8:0:42:: icmp_seq=3 ttl=64 time=.0314 ms
68 bytes from 2001:db8:0:42:: icmp_seq=4 ttl=64 time=.0325 ms
68 bytes from 2001:db8:0:42:: icmp_seq=5 ttl=64 time=.0354 ms
Statistics: 5 sent, 5 received, 0% packet loss
```

## IP traceroute

### IP traceroute in default instance

This command allows you to traceroute to a particular IP destination.

## Syntax

```
tracert <destination-ip> [source-interface <interface>] repeat <repeat>
interval <interval> size <pktsize> source-ip <source-ip> maxhop <maxhop>
```

destination-ip	ipv4 destination address
interface	source interface
repeat	no of packets for each hop (default 3)
interval	interval between the packets (default 1 sec)
pktsize	size of the traceroute packet (default 60)
source-ip	source IP address
maxhop	max number of hops before the TTL expires (default 30)

## Example

```
admin@rtbrick: op> tracert 198.51.100.80
tracert to 198.51.100.80, 30 hops max, 60 byte packets
 1  198.51.100.90    39.401 ms    19.919 ms    20.074 ms
 2  198.51.100.80    55.544 ms    36.765 ms    45.989 ms
```

## IP traceroute in specific instance and afi/safi

This command allows you to traceroute to a particular IP destination in a specific VRF.

## Syntax

```
tracert <destination-ip> [instance <instance-name> afi <afi> safi<safi>]
[source-interface <interface>] repeat <repeat> interval <interval> size <pktsize>
source-ip <source-ip> maxhop <maxhop>
```

destination-ip	ipv4 destination address
instance-name	instance on which traceroute has to be executed
afi	IPv4 Address Family Identifier (AFI)
safi	Subsequent address family identifier (SAFI)
interface	source interface



repeat	no of packets for each hop (default 3)
interval	interval between the packets (default 1 sec)
pktsize	size of the traceroute packet (default 60)
source-ip	source IP address
maxhop	max number of hops before the TTL expires (default 30)



The afi/safi attributes are optional; if not specified, afi would be ipv4 and safi would be unicast.

### Example

```

supervisor@S1-STD-28-2901>bm13-tst.fsn.rtbrick.net: cfg> traceroute 198.51.100.80
instance default afi ipv4 safi labeled-unicast source-interface
if1-0/0/0/1 source-ip 198.51.100.55
traceroute to 198.51.100.80 30 hops max, 60 byte packets
1  198.51.100.12    4.961 ms    .421 ms    .503 ms
   MPLS Label=20071  Exp=0  TTL=1  S=1
2  198.51.100.80    .995 ms    6.456 ms    .813 ms
    
```



For the MPLS transport, it displays the ingress labels in each hop.

## IPv6 traceroute

### IPv6 traceroute in default instance

This command allows you to traceroute to a particular IP destination.

### Syntax

```

traceroute <destination-ipv6> [source-interface <interface>] repeat <repeat>
interval <interval> size <pktsize> source-ip <source-ipv6> maxhop <maxhop>
    
```

destination-ipv6	ipv6 destination address
interface	source interface
repeat	no of packets for each hop (default 3)
interval	interval between the packets (default 1 sec)
pktsize	size of the traceroute packet (default 60)

source-ip	IPv6 source address
maxhop	max number of hops before the TTL expires (default 30)

## Example

```
admin@rtbrick: op> traceroute 2001:db8:0:75::
traceroute to 2001:db8:0:75:: 30 hops max, 60 byte packets
 1 2001:db8:0:90:: 21.247 ms 20.232 ms 20.052 ms
 2 2001:db8:0:75:: 50.124 ms 59.822 ms 40.032 ms
```

## IPv6 traceroute in specific instance and afi/safi

This command allows you to traceroute to a particular IPv6 destination in a specific VRF.

## Syntax

```
traceroute <destination-ipv6> [instance <instance-name> afi<afi> safi<safi>]
[source-interface <interface>] repeat <repeat> interval <interval> size <pktsize>
source-ip <source-ipv6> maxhop <maxhop>
```

destination-ipv6	ipv6 destination address
instance-name	instance on which traceroute has to be executed
afi	IPv4 Address Family Identifier (AFI)
safi	Subsequent address family identifier (SAFI)
interface	source interface
repeat	no of packets for each hop (default 3)
interval	interval between the packets (default 1 sec)
pktsize	size of the traceroute packet (default 60)
source-ip	IPv6 source address
maxhop	max number of hops before the TTL expires (default 30)



The afi/safi attributes are optional; if not specified, afi would be ipv6 and safi would be unicast.

## Example

```

supervisor@S1-STD-28-2901>bm13-tst.fsn.rtbrick.net: cfg> traceroute
2001:db8:0:75:: instance default afi ipv6 safi labeled-unicast source-interface
ifl-0/0/0/1 source-ip 2001:db8:0:11::
traceroute to 2001:db8:0:75:: 30 hops max, 60 byte packets
1  2001:db8:0:90::      6.782 ms   .306 ms   6.380 ms
   MPLS Label=20072  Exp=0  TTL=1  S=1
2  2001:db8:0:75::      .434 ms   .657 ms   .844 ms

```



For the MPLS transport, it displays the ingress labels in each hop.

## 6.6. LAG

### 6.6.1. LAG Overview

A link aggregation group (LAG) combines multiple physical links into a single logical interface which is referred to as a bundle interface. These physical links are connected between two devices. The device uses LACP protocol to bundle the member links and create high speed connections. Although a bundle can be created based on static configuration, bandwidth can be increased by adding member links to the bundle. This also allows load sharing among the physical links. Thus, a group of ports combined together is called a link aggregation group, or LAG.

The LAG interface combines the bandwidth of the individual member links. The properties like speed and bandwidth of the individual member links should be the same to make it part of that LAG. The traffic which is directed towards the LAG interface is sent on the individual member links. This traffic is not pinned to a specific member link but rather determined by a specific flow. This hash could be calculated based on various fields in the packet.

### Supported Platforms

Not all features are necessarily supported on each hardware platform. Refer to the *Platform Guide* for the features and the sub-features that are or are not supported by each platform.

### LAG Interface Modes

The LAG interface could be formed statically or dynamically. LACP protocol helps to

bring up the interface dynamically. The two modes of LAG interface are:

1. **Static LAG:** In this mode, the member links do not initiate or process any of the LACP packets received. The device brings up the LAG interface without LACP negotiation.
2. **Dynamic LAG:** In this mode, the member links process the LACP packets received. Under this mode, there two sub modes:
  - a. **active:** LACP packets are generated on each of the member links on the transmit side.
  - b. **passive:** LACP packets are generated on the member link in response to the LACP packet received. That means, at least one side of the LAG should be configured as **active** to bring up the LAG interface.

## Layer2 and Layer 3 Interfaces

LAG interfaces can be used as layer 2 and layer 3 interfaces. A regular layer 2 or layer 3 interface can be created on top of the single LAG interface. These interfaces can be divided based on 802.1q VLAN ID's. Multiple layer 3 interfaces can be created and each of them can be associated with different instances.

## LACP (Link Aggregation Control Protocol)

LACP is part of an IEEE specification (802.3ad) that allows several physical ports to be grouped to form a single logical interface. LACP allows a switch to negotiate an LAG by sending LACP packets on its member links. It negotiates the various configuration parameters to bring up the individual member links.

## Supported Number of LAG Interfaces on Platforms

The following tables provide maximum number of LAG interfaces and members per LAG supported on each hardware platform.

### Access-Leaf Platforms

Platform	Max. Number of LAG Interfaces Supported	Number of LAG Members Supported
UfiSpace S9600-72XC	72	10
EdgeCore AGR420	74	10

## Consolidated BNG Platforms

Platform	Number of LAG Interfaces Supported	Number of LAG Members Supported
UfiSpace S9500-22XST	22	10
Edgecore CSR320	24	10
UfiSpace S9510-28DC	NA	NA
Edgecore AGR420	24	10

## Spine Platforms

Platform	Max. Number of LAG Interfaces Supported	Number of LAG Members Supported
UfiSpace S9600-32X	35	10
EdgeCore AGR400	33	10

## L2 Wholesale (L2BSA) Platforms

Platform	Max. Number of LAG Interfaces Supported	Number of LAG Members Supported
UfiSpace S9500-22XST	22	10
Edgecore CSR320	24	10

## Guidelines and Limitations

- You cannot configure logical interfaces on a LAG member ports.
- You cannot configure L2X on a LAG member port.

## 6.6.2. LAG Configuration

### Creating LAG Interfaces

Syntax:

```
set link-aggregation interface <name> <attribute> <value>
```

Attribute	Description
<name>	Specifies the name of the LAG interface. The supported LAG interface names: 'lag-1' to 'lag-99'.
<description>	Link aggregation interface description
mode <mode>	Specifies the LAG mode. The default mode is LACP. The possible modes are: <ul style="list-style-type: none"> <li>• lacp - In this mode, the member links processes LACP packets received. When you create a LAG interface in LACP mode, the LACP PDUs are sent and received through member interfaces.</li> <li>• static: In this mode, the member links do not initiate or process any of the LACP packets received.</li> </ul>
<minimum-link-count>	Specify the minimum number of active member links required for the link aggregation interface.
<member-interface>	Specify name of the member interface.
redundancy-session-id	Specify the value for the redundancy group session ID. Range from 1 to 65535 is allowed.
system-id	Specify the MAC address (as system ID) of the device for the link-aggregation interface.



**redundancy-session-id**, and **system-id** attributes can only be used when you deploy RBFS in redundancy mode. For information about LAG configuration when deploying RBFS in redundancy mode, see [RBFS Redundancy Solution Guide](#).

### Example: LAG Interfaces Configuration

```

supervisor@rtbrick: cfg> show config link-aggregation
{
  "rtbrick-config:link-aggregation": {
    "interface": [
      {
        "interface-name": "lag-3",
        "mode": "lacp",
        "minimum-link-count": 2,
        "member-interface": [
          {
            "member-interface-name": "ifp-0/0/1",
            "lacp-mode": "active"
          }
        ]
      }
    ]
  }
}
    
```

```

    },
    {
      "member-interface-name": "ifp-0/0/5",
      "lACP-mode": "active"
    }
    {
      "member-interface-name": "ifp-0/0/5",
      "lACP-mode": "passive"
    }
  ]
}
}
}

```

## Configuring LAG Member Interfaces

You can add member ports to the LAG interface. The command below allows you to bundle multiple physical interfaces with similar properties like speed, MTU, MRU.

### Syntax:

```
set link-aggregation interface <name> member-interface <name>
<attribute> <value>
```

Attribute	Description
lACP-mode <mode>	<p>Specifies the LACP mode. The default lACP-mode is <b>active</b>.</p> <p><b>active:</b> LACP packets are generated on each of the member links on the LAG, the receive side.</p> <p><b>passive:</b> LACP packets are generated on the member link in response to the LACP packet received at one side of the LAG should be configured as <b>active</b> to bring the LAG interface.</p>

Attribute	Description
lacp-timeout <timeout-value>	<p>Specifies the timeout for the LACP session. A long timeout is 90 seconds, while a short is 3 seconds (default is short). Setting the timeout value will instruct the partner at which interval it should send the updates (30 seconds for long timeout, 1 second for short timeout).</p> <div style="border-left: 1px solid black; padding-left: 10px; margin-top: 20px;">  <p>Having mismatching timeouts will not break the operation, even though it is not desirable design-wise. This is because in LACP both Actor and Partner negotiate the transmission rate, so the transmitter sends at the receiver's expected interval.</p> </div>

## Configuring QoS on LAG Interface

RBFS supports QoS at physical interface level for LAG. Users can apply QoS profile at physical interface level through which one common QoS classification can be applied for all traffic on that port, irrespective of the destination logical interface.

The following features are supported:

- Classification (IEEE-802.1)
- Remarking (IEEE-802.1)
- Ingress Policing
- Egress Policing

For information about configuring the above features, refer the *HQoS Configuration Guide*.



- You cannot apply QoS class of service on LAG logical interface
- Currently, queuing and scheduling are not supported

### Syntax:



```
set interface <physical interface> class-of-service <class-of-service>
```

Attribute	Description
<interface>	Name of the interface
<class-of-service>	Specifies the class of service

### Example:

```
supervisor@rtbrick: cfg> set interface lag-11 class-of-service Retail_profile
supervisor@rtbrick: cfg> commit
supervisor@rtbrick: cfg> show config int lag-11
{
  "rtbrick-config:interface": [
    {
      "name": "lag-11",
      "class-of-service": "Retail_profile"
    }
  ]
}
```

## Configuring L2X on LAG Interface

All forms of L2X that are supported on the regular physical interfaces are supported on LAG. The incoming packet is be matched to a specific L2X profile based on the Cross Connect configuration on the specified LAG interface.

The following match conditions are supported on the LAG interface:

- Incoming LAG interface without any VLAN
- Incoming LAG interface with a single VLAN
- Incoming LAG interface with inner and Outer VLAN
- Incoming LAG interface with any single VLAN
- Incoming LAG interface with inner VLAN and any outer VLAN

For information about configuring L2X, see the L2X Configuration Guide.

The following table provides the L2X match action attributes which are supported on LAG interface.

Attribute	Description
nexthop6 <nexthop>	Next-Hop address
match-type <match-type>	Match types with which traffic can be matched.
service-label <service_label>	Service label value. NOTE: Supported MPLS label values are 0 - 1048575. The reserved MPLS label range is 0 - 15. In RBFS, BGP uses the label range 20000 - 100000. It is recommended to assign label values outside of these reserved ranges to avoid conflicts.
ingress-vlan-operation <ingress-vlan-action>	VLAN operation on ingress side outer VLAN
ingress-outer-vlan <vlan-id>	Outer VLAN at ingress side
outgoing_ifp	Outgoing interface
vlan_operation	VLAN operation
outgoing_outer_vlan1	Outgoing outer VLAN

### 6.6.3. LAG Operational Commands

#### Show Commands

##### Viewing LAG Running Configuration

The following command displays the LAG running configuration on the system.

#### Syntax:

```
show config link-aggregation
```

#### Example: LAG Running Configuration

```
supervisor@dev1: cfg> show config link-aggregation
{
  "rtbrick-config:link-aggregation": {
    "interface": [
      {
        "interface-name": "lag-4",
        "mode": "lacp",
        "minimum-link-count": 4,
```

```

    "member-interface": [
      {
        "member-interface-name": "ifp-0/0/1",
        "lACP-mode": "active",
        "lACP-timeout": "long"
      },
      {
        "member-interface-name": "ifp-0/0/4",
        "lACP-mode": "active",
        "lACP-timeout": "long"
      }
    ]
  }
]
}
}

```

## Viewing LAG Information

The following command displays the LAG information.

### Syntax:

```
show lag <options>
```

Option	Description
<interface-name>	Displays information for a specific LAG interface
detail	Displays detailed LAG information
mode <mode>	Displays information for a LAG mode: <b>static</b> or <b>LACP</b>

### Example: Viewing LAG Information

```

supervisor@rtbrick: cfg> show lag detail

Lag interface name: lag-3
Status:             Up
Minimum link count: 2
Mode:               lacp
Member interface name: ifp-0/0/1
  Actor system id: 04:f8:f8:e9:bc:83
  Actor key: 107
  Partner system id: 04:f8:f8:e9:bf:83
  Partner key: 43
Member interface name: ifp-0/0/5
  Actor system id: 04:f8:f8:e9:bc:83
  Actor key: 107
  Partner system id: 04:f8:f8:e9:bf:83
  Partner key: 43

```

## Viewing LAG QoS Policer Counters

The following command displays the QoS Policer Counters.

### Syntax:

```
show qos policer counter
```

### Example 1: QoS policer counter

```
supervisor@rtbrick: cfg> show qos policer counter
Interface                               Level Units      Total      Received
Dropped
lag-27                                   1   Packets    0          0
0
                                           Bytes    0          0
0
lag-27                                   2   Packets    0          0
0
                                           Bytes    0          0
0
lag-27                                   3   Packets    0          0
0
                                           Bytes    0          0
0
lag-27                                   4   Packets    0          0
0
                                           Bytes    0          0
0
lag-28                                   1   Packets    0          0
0
                                           Bytes    0          0
0
lag-28                                   2   Packets    0          0
0
                                           Bytes    0          0
0
lag-28                                   3   Packets    0          0
0
                                           Bytes    0          0
0
lag-28                                   4   Packets    203        0
203
                                           Bytes    18270     0
18270
lag-29                                   1   Packets    0          0
0
                                           Bytes    0          0
0
lag-29                                   2   Packets    0          0
0
                                           Bytes    0          0
0
lag-29                                   3   Packets    20591812  18850600
```

1741212				
		Bytes	21291933608	19491520400
1800413208				
lag-29	4	Packets	0	0
0				
		Bytes	0	0
0				
lag-27-egress	1	Packets	0	0
0				
		Bytes	0	0
0				
lag-27-egress	2	Packets	0	0
0				
		Bytes	0	0
0				
lag-27-egress	3	Packets	2011928	2011928
0				
		Bytes	2116548256	2116548256
0				
lag-27-egress	4	Packets	180377	180377
0				
		Bytes	15574914	15574914
0				
lag-28-egress	1	Packets	0	0
0				
		Bytes	0	0
0				
lag-28-egress	2	Packets	0	0
0				
		Bytes	0	0
0				
lag-28-egress	3	Packets	2019661	2019661
0				
		Bytes	2124683372	2124683372
0				
lag-28-egress	4	Packets	178226	178226
0				
		Bytes	15398532	15398532
0				
lag-29-egress	1	Packets	0	0
0				
		Bytes	0	0
0				
lag-29-egress	2	Packets	0	0
0				
		Bytes	0	0
0				
lag-29-egress	3	Packets	1999328	1999328
0				
		Bytes	2103293056	2103293056
0				
lag-29-egress	4	Packets	183300	183300
0				
		Bytes	15893128	15893128
0				

**Syntax:**

**show qos policer counter <lag interface>**

### Example 2: QoS policer counter for a specified LAG

```

supervisor@rtbrick: cfg> show qos policer counter lag-29
Interface                               Level  Units      Total      Received
Dropped
lag-29                                  1      Packets     0          0
0                                         Bytes      0          0
0
lag-29                                  2      Packets     0          0
0                                         Bytes      0          0
0
lag-29                                  3      Packets     21241103   19499891
1741212                                     Bytes      21963300502 20162887294
1800413208
lag-29                                  4      Packets     0          0
0                                         Bytes      0          0
0

```

### Example 3

```

supervisor@rtbrick: cfg> show qos policer counter lag-29-egress
Interface                               Level  Units      Total      Received
Dropped
lag-29-egress                           1      Packets     0          0
0                                         Bytes      0          0
0
lag-29-egress                           2      Packets     0          0
0                                         Bytes      0          0
0
lag-29-egress                           3      Packets     2071701    2071701
0                                         Bytes      2179429452   2179429452
0
lag-29-egress                           4      Packets     187300     187300
0                                         Bytes      16221128     16221128
0

```

## 6.7. HQoS

## 6.7.1. Hierarchical Quality of Service (HQoS) Overview

Hierarchical Quality of Service (HQoS) is a traffic classification and prioritization framework that allows you to provide different Service Level Agreements (SLAs) on bandwidth usage. It allocates network resources to services on a prioritized basis. This is achieved by classifying, policing, shaping, scheduling and remarking the traffic based on service types. The HQoS service can be applied to Ethernet, IPv4, IPv6 or MPLS packets. The framework supports QoS at multiple levels. At only one level it allows you to allocate resources between services, but when configured at multiple levels through HQoS, it allows complex prioritization schemes.

The RtBrick Full Stack (RBFS) uses the following HQoS mechanisms:

- **Classifier:** Classifies each incoming packet as belonging to a specific class, based on packet contents. Supported classifiers are Behavior Aggregate (BA) and Multifield (MF). In the BA classifier, packets are classified according to the CoS field: IEEE 802.1p, IPv4/v6 ToS/TC, or MPLS EXP. In the MF classifier, packets are classified using additional fields in the IP header: source IPv4/IPv6 prefix, destination IPv4/IPv6 prefix, L4 source port, L4 destination port, and/or IP protocol.
- **Policer:** Policer is implemented in the ingress to drop the unwanted traffic. Policer supports the Committed Information Rate (CIR), the Committed Burst Size (CBS), the Peak Information Rate (PIR), and the Peak Burst Size (PBS). Drop behavior is to either mark traffic as green, yellow, or drop.
- **Queuing:** Drop unqualified packets in advance using the Weighted Random Early Detection (WRED) technology in the case of congestion to ensure bandwidth for qualified services. This is performed at the egress.
- **Scheduler:** Manage traffic on a device using different algorithms for queue scheduling. Such algorithms include Fair Queuing (FQ), Weighted Round Robin (WRR), and Strict Priority (SP). Queues can be connected to schedulers and schedulers can also be connected to other schedulers.
- **Shaper:** Shaper is implemented in the egress, traffic shaping involves buffering and delaying traffic to shape the flows. Shapers are implemented either on queues or schedulers.
- **Remarking:** Remarking allows you to rewrite the outgoing packet's codepoint. Remarking can be performed in the ingress or the egress side of the hardware pipeline.

The figure below shows how QoS does ingress and egress traffic management

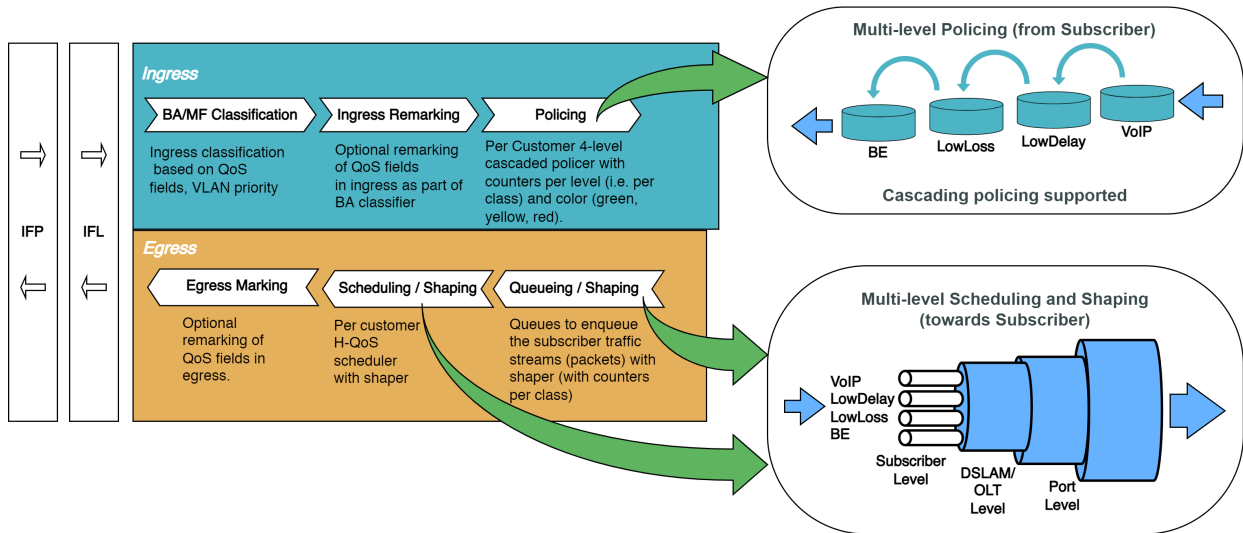

The sections below provide a description of various HQoS components that are configured for both ingress and egress traffic.

- QoS Profiles
- Behavior Aggregate (BA) Classifier
- Multifield (MF) Classifier
- Remarking
- Policer
- Class-Policer-Map
- Queueing
- Traffic Class to Queue Mapping
- Queue-Group
- Scheduler
- Priority Propagation
- Shaper
- Scheduler Mapping
- L2TP QoS
- Multi-level H-QoS : Level-1 to Level-5



## QoS Profiles

A profile configuration defines the QoS profile that is attached to either a Subscriber interface or an L3 interface.

Profile maps the following QoS constructs to a Subscriber or an L3 interface:

- Behavioral Aggregate (BA) Classifier
- Multifield (MF) Classifier
- Class Policer Map
- Policer
- Class Queue Map
- Scheduler Map
- Remark Map

### Behavior Aggregate (BA) Classifier

Classifiers assign the class to which a packet belongs. BA classification is performed on the ingress and maps incoming packet codepoint to a predefined class. BA Classification relies upon markings (that is, codepoint) placed in the headers of incoming packets:

- IEEE 802.1p: Priority - 3 bits
- IPv4: Type of Service byte (ToS) - 8 bits.
- IPv6: Traffic Class (TC) - 8 bits.
- MPLS: Experimental bits (EXP) - 3 bits.



- IEEE 802.1p and IPv4/IPv6 classifiers are applied on either Subscriber IFL or L3 IFL by attaching the BA classifier to a profile.
- MPLS Exp classifiers are applied either globally or per instance (to support multiple VPN marking schemes) by attaching the classifier globally or to an instance.

Classifier configuration has the following guidelines and limitations:

- For IPv4: Only ToS-based classification is possible. Currently, DSCP-based

classification is not supported.

- For IPv6: TC-based classification is possible.
- For EXP classification, RBFS uses the uniform mode to copy MSB 3-bits from 8-bits IPv4-ToS or IPv6-TC to the EXP field at the time of MPLS encapsulation at the remote box. IPv4/IPv6 Classifiers do not classify labeled traffic, hence MPLS Classifier is required for the same.



- Default class for Queue or Policer is *class-0*. If for an incoming packet's *codepoint* there is no class mapping configured under a classifier, the packet will be classified as *class-0*.
- RBFS supports 8 **classes**: *class-0* to *class-7*.

## Ingress Remarking

Ingress remarking is achieved by configuring the “remark-codepoint” field in the Classifier. Ingress remarking rewrites the IPv4-ToS or IPv6-TC field of the incoming packet at the ingress side with configured remark-codepoint. Note that the ingress remarking is not supported for the BA Classifier with match-type MPLS-EXP.

## Multifield (MF) Classifier

Multifield (MF) classifiers assign the class to which a packet belongs based on multiple fields. Unlike the BA classifier, where only CoS fields are used for classification, the MF classifier additionally uses the following fields:

- **class**: traffic class of the packet (class-0 to class-7) set by prior BA classifier
- **source prefix**: source IPv4 or IPv6 prefix
- **destination prefix**: destination IPv4 or IPv6 prefix
- **protocol**: UDP or TCP
- **source port**: UDP or TCP source port
- **destination port**: UDP or TCP destination port
- **qos markings**: IPv4 TOS or IPv6 TC header value

The actions supported by a Multifield Classifier are:

- **class**: traffic class to be set (class-0 to class-7)
- **Remark codepoint**: remark codepoint for ingress remarking



RBFS treats all the incoming IPv4-TOS or IPv6-TC QoS field values in the incoming packet as untrusted. So a user is required to set **action-remark-codepoint** in the MF Classifier configuration to mark the QoS bits in the IP header of the outgoing packet. If **action-remark-codepoint** is not configured in the MF Classifier, the default value 0 shall be marked in the packet.

The Multifield Classifiers can be bound globally (`global.qos.global.config`) or via QoS profile (`global.qos.profile.config`). The global Multifield Classifier applies to all traffic from any instance or interface. The Multifield Classifier assigned via the QoS profile applies only to ingress traffic received on the interface where the profile is bound to it.

The Multifield Classifier is processed after BA classification which allows it to match on selected class from BA classification or to change the assigned class by more granular match conditions. Both classification stages (BA and MF) are optional, they can be combined or used alone, controlled by configuration.

Multifield Classifiers cannot be bound to MPLS core interfaces. Therefore, the downstream traffic (from core to subscriber) should be classified via global Multifield Classifier, while upstream traffic (from subscriber to core) can be classified via Multifield Classifier from the QoS profile, which is instantiated per subscriber with an implicit match on ingress logical interface (InLIF).



- RBFS supports 8 **classes**: *class-0* to *class-7*.
- Per instance MF classifier for MPLS traffic is not supported in RBFS because of hardware limitations.
- The default class for Queue or Policer is **class-0**. If for an incoming packet, there is no MF classification configured, the packet will be classified as *class-0*.
- Priority 1 is reserved for BA Classifier ACL entries, therefore the recommendation is to use Priority starting from 2 for MF Classifier
- If multiple ACL entries are hit in MF having the same priority, the result is unpredictable. So recommendation is to use different priorities for different ACL entries.

## Match MPLS traffic

If MF Classifier is to be applied for MPLS traffic (that is, DOWNSTREAM traffic), match MPLS traffic has to be configured in the MF ACL. If not configured, traffic may or may not match the MF ACL entry in the h/w.

## Ingress Remarking

Ingress remarking is achieved by configuring the “action remark-codepoint” in the MF Classifier. Ingress remarking rewrites the IPv4-ToS or IPv6-TC field of the incoming packet at the ingress side with configured remark-codepoint.

## RADIUS Controlled Dynamic MF Classifier

As described in *RBFS RADIUS Services* document dynamic MF Classifier mapping is supported. The dynamic MF Classifier when configured overrides the MF Classifier mapped via QoS profile for the corresponding subscriber but not other subscribers.

For information about configuring the MF Classifier, see [\[hqos:hqos\\_intro:::mf\\_classifier\\_configuration\]](#).

## Layer 2 Access Control Lists (ACL) Priority Bit Egress Classifier

L2 ACL p-bit egress classifier assigns the class to which a packet belongs based on traffic direction (ingress) and outer VLAN priority fields.

- **direction:** Direction of the packet, that is, ingress
- **service-outer-vlan-priority:** Qualifies the packet based on priority bit in the the outer VLAN (IEEE-802.1p)
- **interface-meta-data:** To qualify the packet based on L2 ACL, interface metadata is mandatory (type-1)

The actions supported by a L2 ACL priority bit Egress Classifier are:

- **forward-class:** traffic class to be set on the qualified packets (class-0 to class-7)



- When EVPN-VPWS L2 interfaces are required to create L2 business services, the shared code points have to be corrected at egress to ensure the correct classification towards the subscriber. The egress classification of packets based on L2

ACL is supported.

## Policer

Policer defines the rate at which certain applications can access the hardware resource. So as to rate-limit the traffic from an application, the policer hard-drops the unwanted packets on the ingress side.

In RBFS, policers support the **“two-rate, three-color”** type in a 4-level cascaded mode. This means that each policer level has two rates (CIR and PIR) and three colors (green, yellow and red) with two token buckets as shown below.

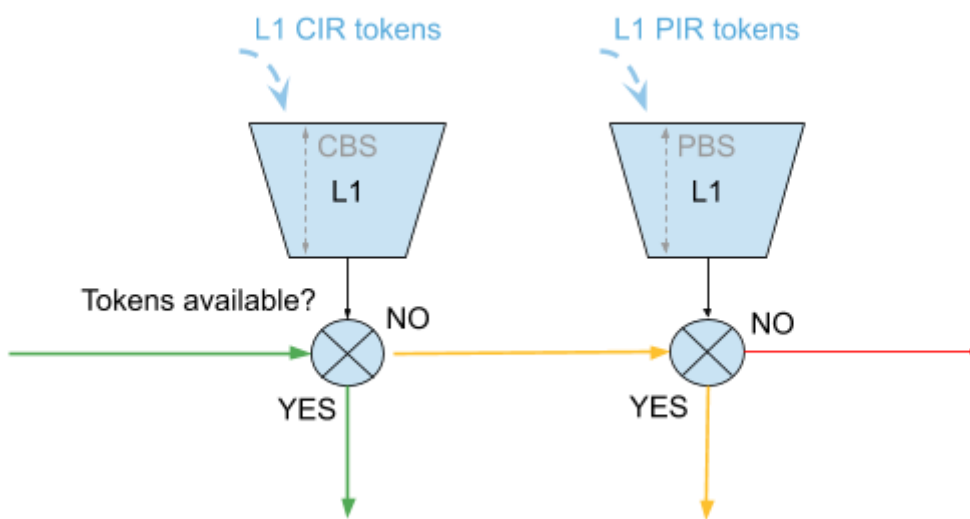

This means that traffic below CIR is marked green. Traffic above CIR but below PIR is yellow and above PIR is red. Traffic marked red will be dropped. Traffic marked yellow can be demoted by changing ToS, TC, or EXP using remark map.

In 4-level cascade mode, unused tokens can be passed from higher priority levels to lower priorities where level 1 has the highest and level 4 has the lowest priority as shown in the figure below.

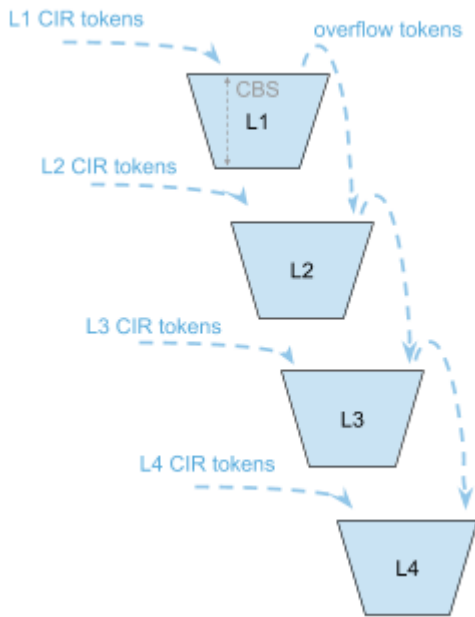

Therefore a lower level configured with CIR 0 can still serve traffic if higher priority levels are not consuming all available tokens.

The available tokens per level are calculated by remaining CIR credits from upper levels and additional credits based on configured CIR per level. Per default, the resulting tokens are not limited. The optional max CIR rate attribute limits tokens from CIR and upper levels. Let us assume levels 1 and 2 are both configured with a CIR of 2Mbps. Without max CIR or max PIR (default behaviour) level 2 can reach up to 4Mbps (level 1 CIR/PIR plus level 2 CIR/PIR). This can be limited by max CIR (for example, 3Mbps). If both level 1 and level 2 have a committed information rate (CIR) of 2Mbps, then level 2 can reach a maximum of 4Mbps (which is the sum of level 1 CIR and level 2 CIR) without any consideration for the maximum CIR. However, the maximum CIR is not relevant for level 1.



In a single-level (levels=1) mode, only level 1 CIR & PIR rates should be configured.

### Example

	<b>CIR</b>	<b>RX</b>	<b>TX</b>	<b>PIR</b>	<b>RX</b>	<b>TX</b>
L1	2M	1M	1M	2.5M	1M	1M
L2	3M	20M	9M	3.5M / max CIR 8	20M	8M
L3	4M	20M	0M	4.5M	20M	1M

	<b>CIR</b>	<b>RX</b>	<b>TX</b>	<b>PIR</b>	<b>RX</b>	<b>TX</b>
L4	1M	20M	0M	1.5M	20M	0M
SUM	10M	61M	10M	12M	61M	10M

- Here, **M** indicates Mbps (Megabits per second)

In columns 2 through 4 of the preceding example table, L1 consumes only 1Mbps of the available 4Mbps and passes the remaining 3Mbps to L2 which adds 6m based on their own configured CIR resulting in 9m.

In columns 5 through 7 of the preceding example table, L1 consumes only 1Mbps of the available 4Mbps and passes the remaining 3m to L2 which adds 6Mbps based on their own configured CIR resulting in 9Mbps. But because of the CIR limit set to 8Mbps, only 8Mbps of 9Mbps can be used at this level. The remaining 1Mbps is now passed to L3 which does not add additional CIR-based credits. In both examples, L4 would be able to reach up to 10Mbps if upper levels are not consuming credits.

## RADIUS Controlled Dynamic Policer

The RBFS RADIUS services support dynamic policer rate updates. The dynamic policer rate when configured affects only the QoS instance of the corresponding subscriber but not other subscribers.

### Class-Policer-Map

Since RBFS supports up to 8 classes but only four policer levels, there is a need to map multiple classes to the same policer level. A *class-policer-map* defines such mappings. Using class-policer-map configuration, one can map any class to any supported policer level (that includes mapping multiple or all classes to the same level). Similar to a policer, a class-policer-map is attached to a profile.



If class-to-level mapping is not configured, no policing will be applied to the traffic for that class.

## 7. Queueing

Queueing helps to drop unwanted traffic in advance at the ingress side in case of congestion. This is to ensure bandwidth for qualified services.

RBFS supports the following queueing techniques:

- Tail Drop (TD): This is a conventional congestion avoidance technique. When the network is congested, drop subsequent packets from the queue.
- Weighted Random Early Detection (WRED): This technique requires configuring “Minimum Threshold”, “Maximum Threshold” and “Drop Probability”, which define the start and end range where packets may get discarded. When the average queue size is below the minimum threshold, no packets will be discarded. The `drop_probability` parameter can be used to specify the drop probability at the max threshold. When the average queue size is between the min and max threshold, the drop probability increases linearly from zero percent (at the min threshold) to `drop_probability` percent (at the max threshold). When the average queue size is greater than the maximum threshold, all packets are discarded.

When the average queue size is less than the “Minimum Threshold”, no packets will be discarded.

When the average queue size is greater than the “Maximum Threshold”, all packets are discarded.

When the average queue size is between “Minimum Threshold” and “Maximum Threshold”, the drop probability increases linearly from zero percent (at the minimum threshold) to drop probability (at the max threshold).



- Default queue within a queue group is the one mapped to *class-0*. If the classification is not configured for an incoming packet's codepoint, the packet will be classified as *class-0*. This will be mapped to queue mapped to *class-0* in *Class-Queue-Map*. For more information, see [Traffic Class to Queue Mapping](#).
- Maximum supported Queue size depends upon DRAM/OCB memory. Since OCB is external memory, hardware does not limit the size that can be configured per Queues.



## RADIUS Controlled Dynamic Queue

As described for *RBFS RADIUS Services* document dynamic Queue buffer size updates are supported. The dynamic Queue buffer values when configured affect only the QoS instance of the corresponding subscriber but not other subscribers.

### Traffic Class to Queue Mapping

The traffic class to queue mapping defines the mapping of classes and queues. The Traffic Class to Queue Mapping is attached to a profile.



- You cannot map two classes to the same queue. The class to queue mapping is 1:1.
- If a queue group is created with four queues, only class-0 to class-3 can be mapped to the queues in class-queue-map; that is, class-4 to class-7 cannot be used.

## 8. Queue-Group

A Queue Group defines the Queue bundle. A Queue Group contains bundle of either 1 or 4 or 8 queues.

## 9. Scheduler

A scheduler configuration defines scheduler parameters such as type and shaping rate. The shaping rate defined for a scheduler applies to queue(s) associated with it. NOTE: For 1 Queue in Queue-Group, scheduler is not applicable.

The following scheduler types are supported:

- **Fair Queueing (FQ):** Uses a round-robin approach to select the next packet to service. This method ensures that all the flows are serviced equally. Configure scheduler type as *fair\_queueing* to create FQ scheduler.

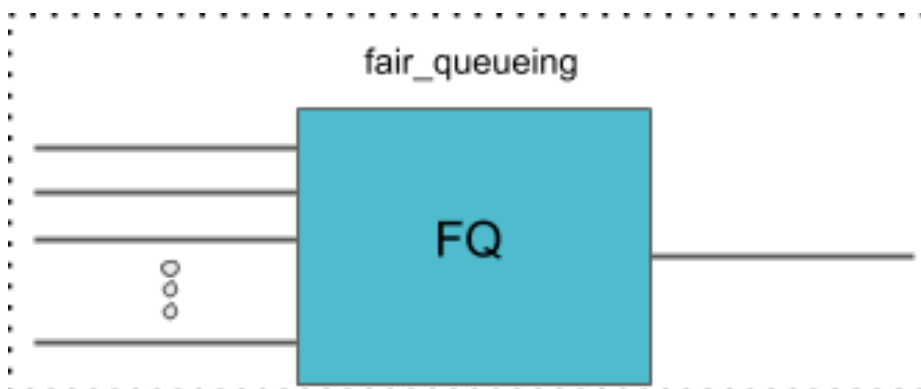

- **Weighted Fair Queueing (WFQ):** Uses a round-robin approach but with no guarantee of flow being serviced equally (like in FQ). The rotation of the next packet to service is based on the weight that is assigned to each flow. Configure scheduler type as *weighted\_fair\_queueing* to create WFQ scheduler.

Supported weight: 1 to 253

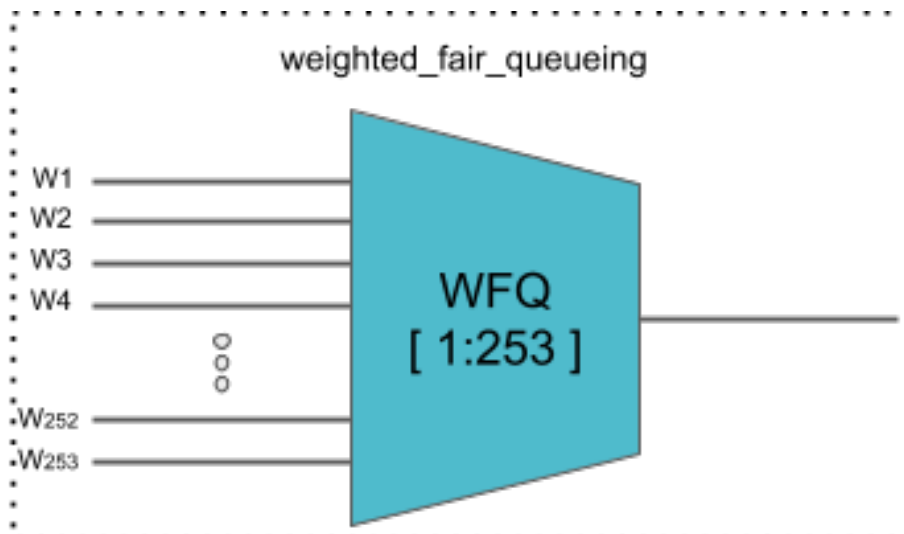

In any WFQ scheduler, the lower the weight, the higher the

bandwidth portion is awarded.

- **Strict Priority (SP):** Uses priority-based approach to service the flow. SP schedulers are supported in “hybrid” mode only. Hybrid mode combines FQ-WFQ schedulers using strict priority.



The priority order for SP is: **strict\_priority\_0 > strict\_priority\_1 > strict\_priority\_2 > strict\_priority\_3** (where **strict\_priority\_0** being highest priority and **strict\_priority\_3** being lowest)

The following SP scheduler types are supported:

- **2 Strict Priority (2SP):** Uses SP between 1-FQ and 1-WFQ. There are the following types of 2SP hybrid schedulers:

type “**2sp\_wfq\_independent**”

Supported weight: 1 to 63

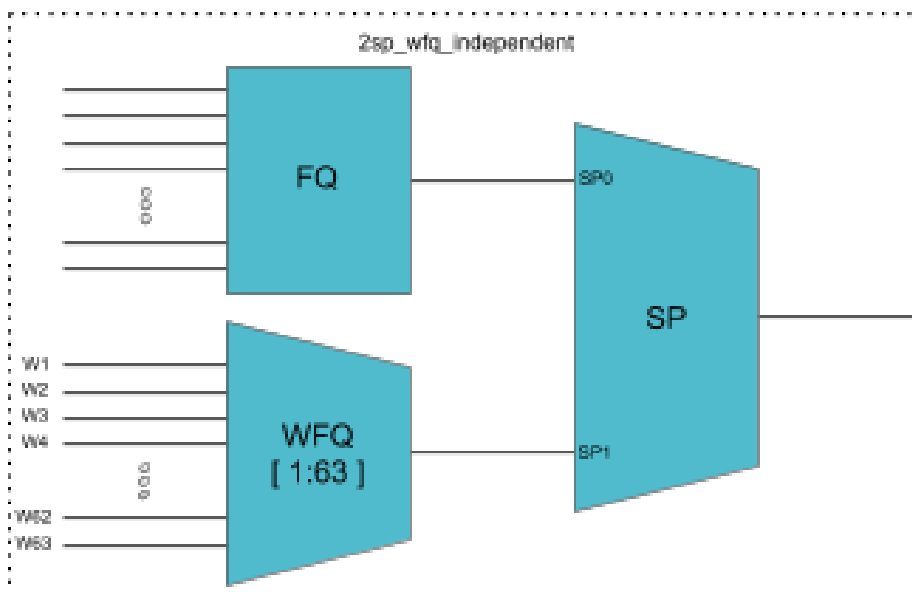

- type “**2sp\_wfq\_discrete**”

Supported weight: { 1, 2, 3 }

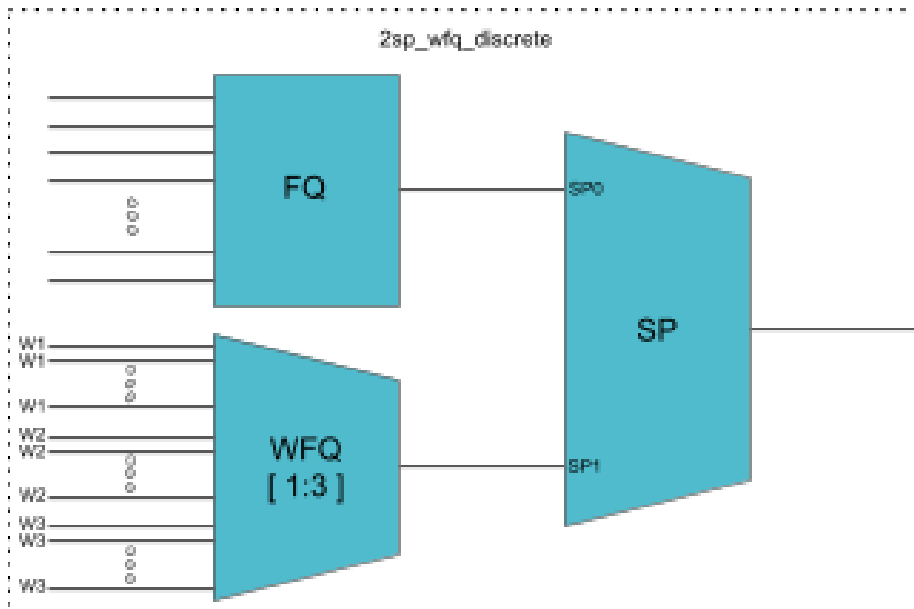

- type **"wfq\_independent\_2sp"**

Supported weight: 1 to 63

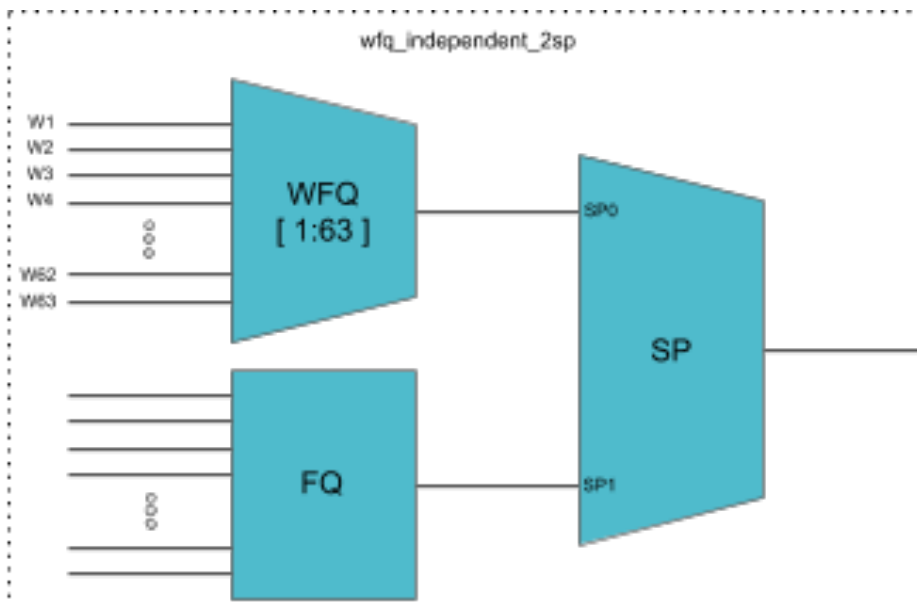

- type **"wfq\_discrete\_2sp"**

Supported weight: { 1, 2, 3 }

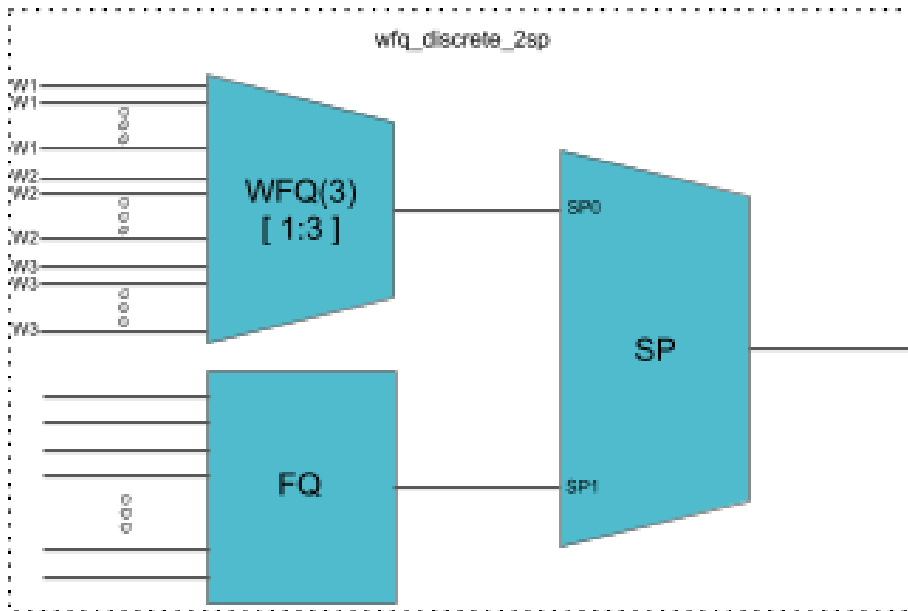

- **3 Strict Priority (3SP):** maps 2-FQs and 1-WFQ

type: **"3sp\_wfq\_discrete"**

Supported weight: { 1, 2 }

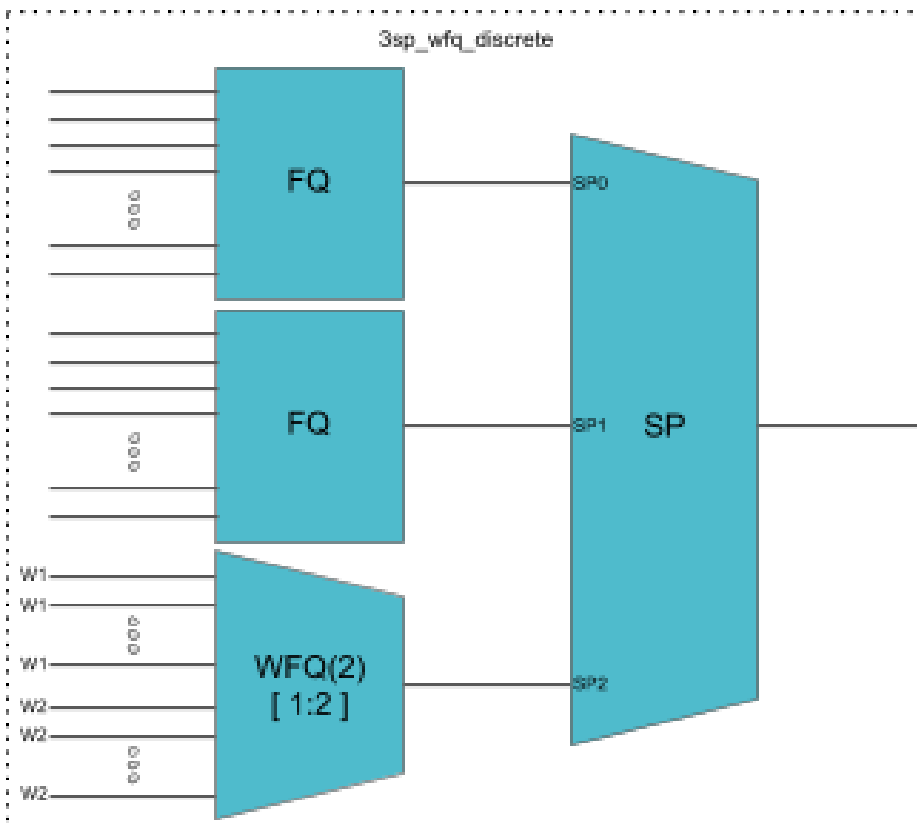

- **4 Strict Priority (4SP):** maps 4-FQs using SP

type **"strict\_priority"**

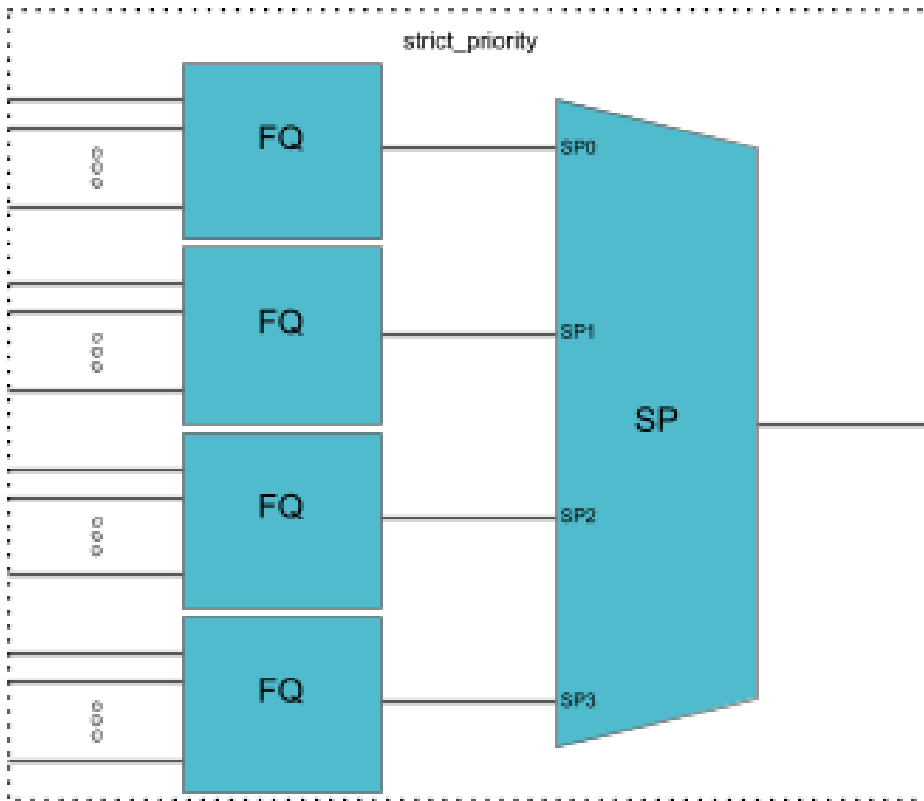

### Priority Propagation

Hierarchical QoS (HQoS) on RBFS is implemented by connecting or chaining queues to scheduler elements (Q → SE), scheduler elements to each other (SE → SE), and scheduler elements to ports (SE → PORT). Each scheduler element can have different child connection points based on types described in the section [Scheduler](#).

This means that sched\_0 in the example below is not scheduling between the attached queues, but between the different child connection points SP0 to SP3. The scheduler element sched\_0 cannot differentiate between Q1 and Q2 in this example because both are connected to SP2.

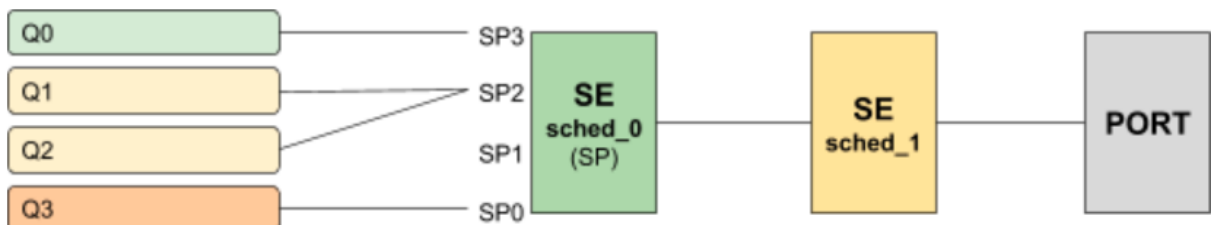

Without priority propagation, each scheduler element can have multiple child connection points but just one parent connection point. Therefore traffic leaving a scheduler element cannot be differentiated by the parent scheduling element. The parent scheduler element sched\_1 receives the traffic from sched\_0 on the

selected child connection point. As already mentioned scheduling within a scheduler element happens between child connection points. Second, a scheduler element has only one parent connection point which can be connected to a child connection point of another scheduler element (output of sched\_0 input of sched\_1). This results in the situation that all traffic from this SE is handled equally regardless of the queue. This may lead to dropped priority traffic like voice or control traffic in case of congestion in parent elements. For example, if sched\_1 has a shaping rate lower than the one of sched\_0, it will drop traffic unaware of its original priority.

This problem is addressed with priority propagation which is enabled by default.

With priority propagation, the scheduler elements operate in a dual-flow mode with high and low-priority flows. The credits generated from the physical interface will be consumed by all attached high-priority flows first and only the remaining credits will be available for low-priority flows. In this mode, an implicit FQ element is created for each scheduler element. All queues assigned to low-priority flow will be attached to this element.

An additional composite option of the scheduler element allows also the differentiation between multiple low-priority queues if required. This composite type is created implicitly and does not need to be configured.

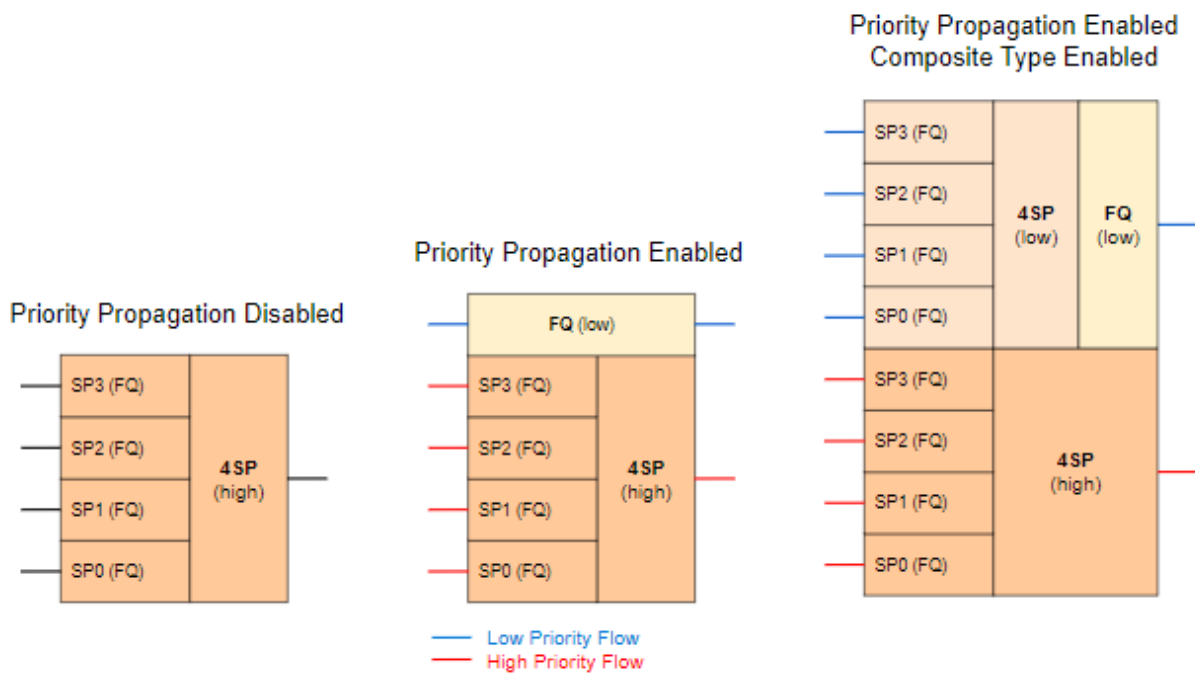

Without priority propagation enabled, each scheduler element consumes only one scheduler resource compared to two elements if enabled. The composite type



consumes three scheduler elements.

With priority propagation disabled, all traffic is considered a high-priority flow.

Now for each queue, we can select if connected to high-priority or low-priority flow where high-priority flow is selected per default if not explicitly mentioned.

Assuming the example as before but with priority propagation and Q0 assigned to low-priority flow and Q1 - Q3 assigned to high-priority flow.

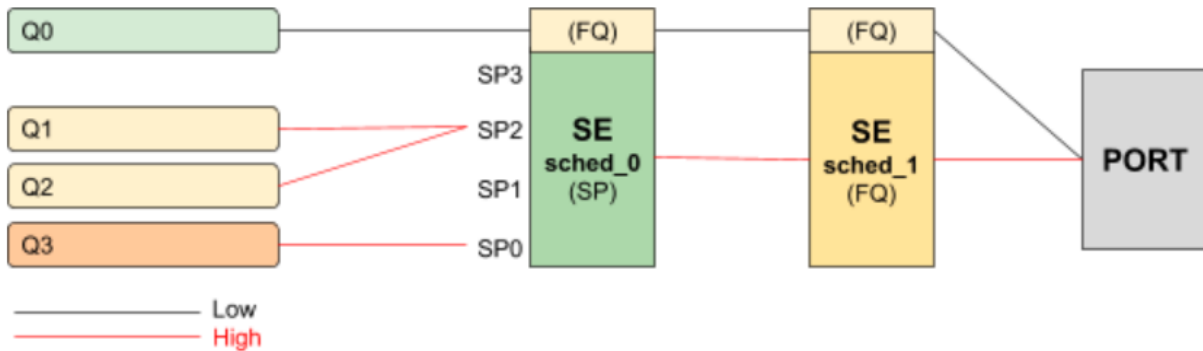

The figure below shows a typical multi-level QoS configuration without priority propagation on the left and with priority propagation on the right side.

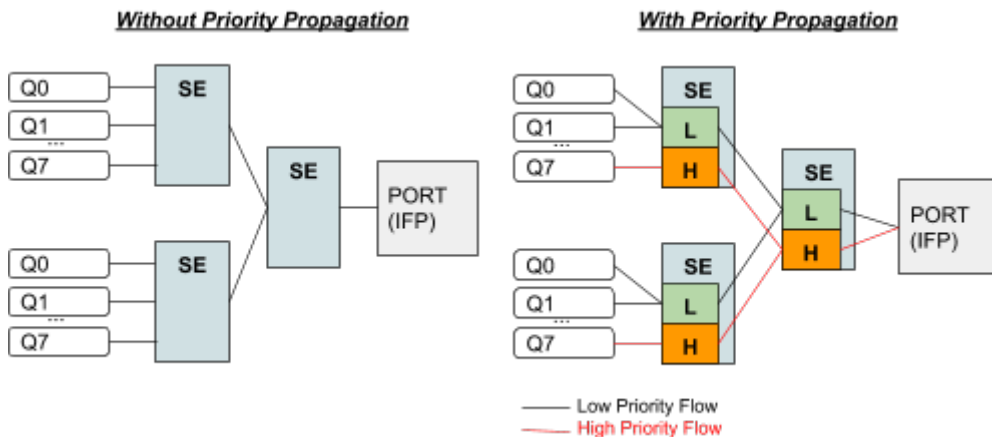

The credits generated from the physical interface will be consumed by high-priority flow first and the remaining credits will be available for low-priority flow. The high-flow traffic at any one element is scheduled based on the type and connection point. Between schedulers, it depends on how they are connected to the parent scheduling element. Per default all levels there is FQ for low and FQ for high-priority flows. The port scheduler is also FQ.

In this mode, each shaper supports two different rates for low and high-priority

where the actual shaper rate is the sum of low and high-priority rates. If the low-priority rate is zero, this flow is only served if the high-priority flow is not consuming all credits. An example might be a high rate of 9Mbps and a low rate of 1Mbps which results in 10Mbps for low-priority flow if high-priority flow is not consuming any packets but at least 1Mbps is ensured.

The following example shows a typical access service provider configuration with priority propagation enabled with and without composite type.

Priority Propagation Enabled

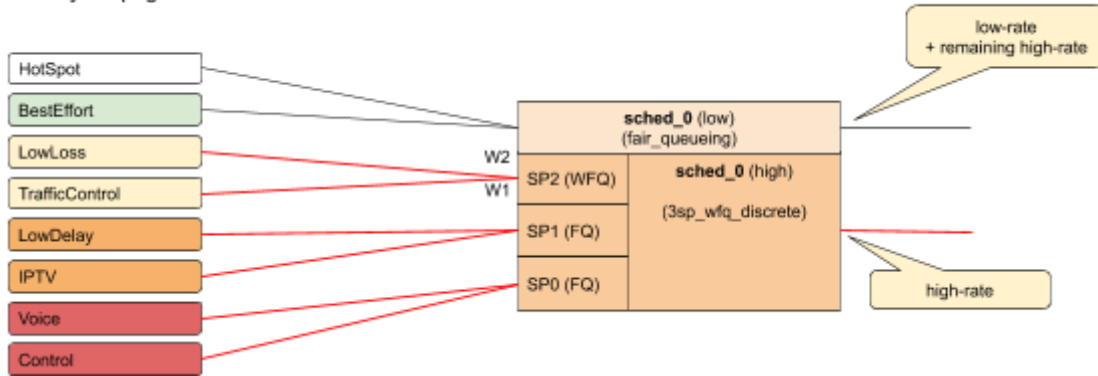

Priority Propagation Enabled  
Composite Type Enabled

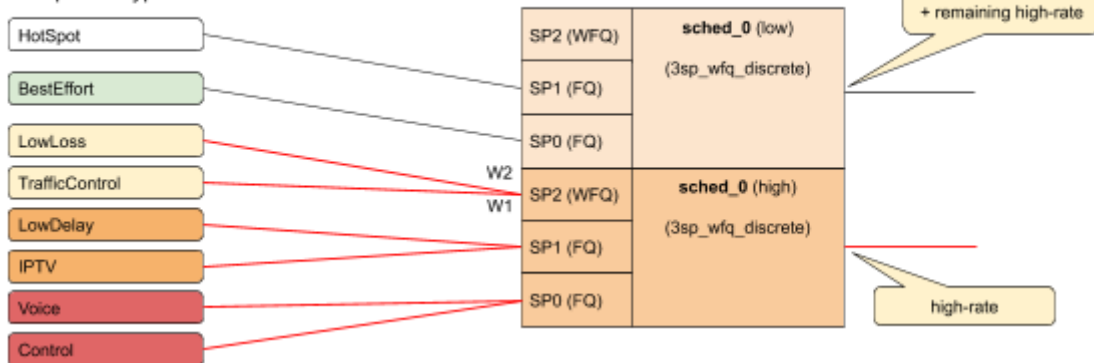

### Simple Priority Propagation Scheduling Example

Without priority propagation, the parent scheduler drops traffic equally from all classes as it is unaware of priorities:

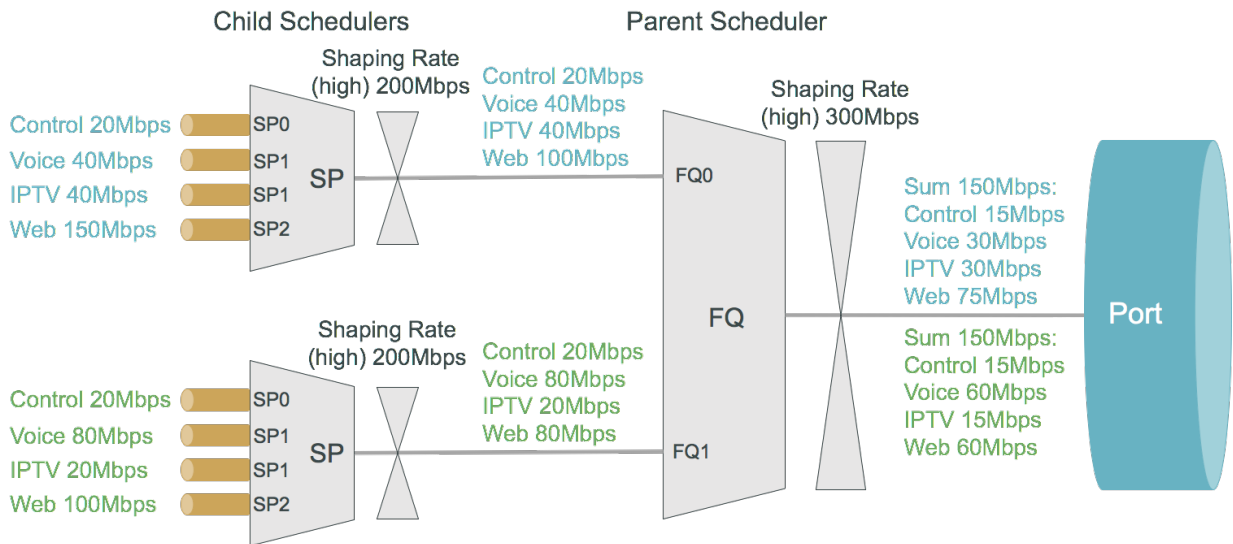

With priority propagation, the parent scheduler serves high-priority flows first as shown in the figure below:

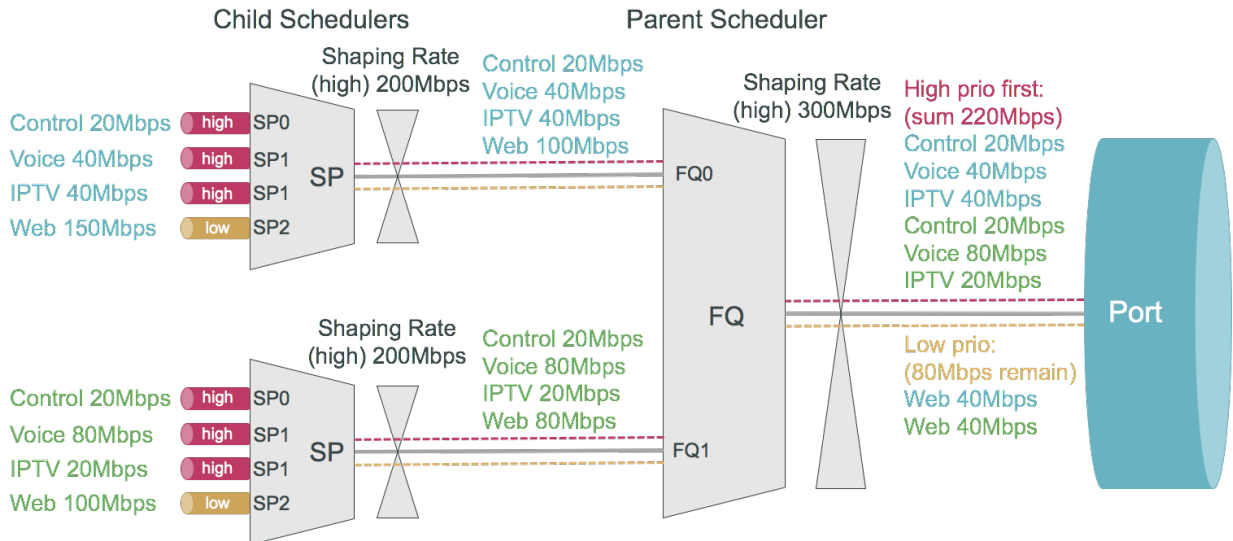

With priority propagation and dual-flow shaping, the parent scheduler serves high-priority flows first up to the high-flow shaping rate:

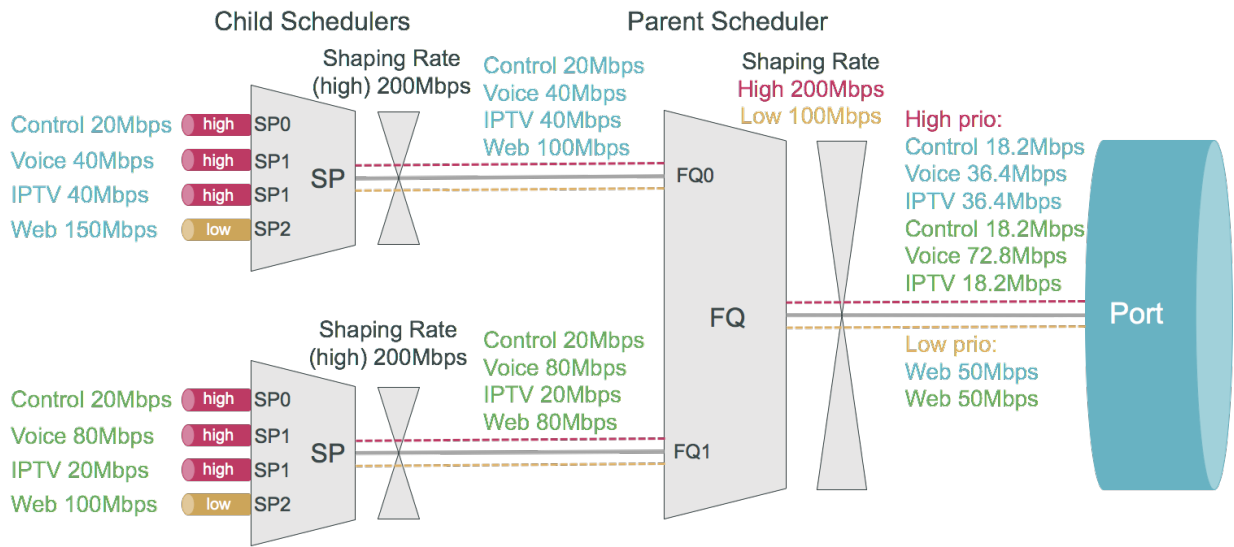

# 10. Shaper

Shaper is used to rate-limit the traffic at the egress. In RBFS, shapers can be attached to both Queue and Scheduler.

A shaper configuration defines the shaping rate in Kilo-bits-per-second (Kbps).



- Setting the shaping rate to 0 (zero) sets the rate to unlimited. Hence it is recommended to configure at least 1 Kbps so that shaping takes place.
- If shaping rates are to be unconfigured, it needs to be done at all scheduler levels.

## 10.1. Low-rate Shaping

The Low-rate Shaping feature performs queueing and scheduler-level traffic shaping to rates lesser than 1000 Kbps so that the higher-priority (voice) traffic to flow at optimal levels.



Low-rate Shaping is supported only on high-priority flows, that is high-flow configuration parameter.

RBFS Access-Leaf and Consolidated-BNG platforms have been enabled with Low-rate Shaping by default. For information about the Low-rate Shaping feature enabled platforms, see section 'Feature/Resource Usage' in the *Platform Guide*.

### RADIUS Controlled Dynamic Shapers

RBFS RADIUS services support dynamic shaper updates. The dynamic shaper when configured affects only the QoS instance of the corresponding subscriber but not other subscribers.

# 11. Scheduler Mapping

Scheduler Map defines the set of relationships between parents and children in egress scheduling hierarchy. A child in a Scheduler Map configuration can be either Queue or Scheduler. A parent in a Scheduler Map configuration can be either a Port or Scheduler.



For 1 Queue in Queue-Group, scheduler-map is not applicable.  
**Connection Point and Weight**

Child-queue or child-scheduler in a scheduler map configuration is connected to the parent-scheduler at “**connection point (CP)**”. Connection point configuration also has “**weight**” associated with it if the parent has a WFQ scheduler corresponding to that connection point. The valid connection point value for a child to connect to parent **WFQ/FQ** scheduler is **no\_priority** and to connect to parent **SP/Hybrid** scheduler is between **strict\_priority\_0** to **strict\_priority\_3** (based on a number of Strict Priority points in parent scheduler).

## Connection Types

There are five connection types in a scheduler map entry:

- queue\_to\_port
- queue\_to\_scheduler
- scheduler\_to\_scheduler
- scheduler\_map\_to\_scheduler\_map
- scheduler\_to\_port



- For the **queue\_to\_port** connection type, the scheduler has no role.

## 12. Remarking

The packet markers set the codepoint in a packet to a particular value, adding the marked packet to a particular behavior aggregate. When the marker changes the codepoint in a packet, it "remarks" the packet. The codepoint in a packet can be IPv4-ToS, IPv6-TC, MPLS-EXP, or IEEE 802.1p field.

The following remarking options are supported in RBFS:

- IEEE 802.1p : Priority - 3 bits.
- IPv4: Type of Service byte (ToS) - 8 bits.
- IPv6: Traffic Class (TC) - 8 bits.
- MPLS-IPv4: MPLS Experimental bits (EXP) - 3 bits.
- MPLS-IPv6: MPLS Experimental bits (EXP) - 3 bits.

IPv4/v6 and IEEE 802.1p remark-map are applied on an interface - subscriber-ifl or l3ifl using Profile Name.

MPLS-IPv4/v6 remark-map is applied either globally or per instance (to support multiple VPN marking schemes) using Remark-Map Name.

In RBFS, remarking can be performed at the ingress or egress:

- **Ingress remarking** is achieved by configuring the **remark-codepoint** field in the Classifier. Ingress remarking rewrites the IPv4-ToS or IPv6-TC at the ingress side with configured remark-codepoint. The configured remark-codepoint can be modified again at the egress side using remark-map. The ingress remarking is supported for IPv4, IPv6, and IEEE 802.1p BA classifiers. Ingress remarking is supported in MF Classifier as well.
- **Egress remarking** is achieved by configuring the **remark-map**. Remark Map is the mapping of **match-codepoint** and **color** to **remark-codepoint**. Egress remarking helps to remark the IPv4-ToS / IPv6-TC field in the IP header, or to write the EXP field in the MPLS label(s), or to write the IEEE 802.1p field in the VLAN header.

Here *Color* is used to set different *remark-codepoint* for same *match-codepoint* based on color marked by the Policer (i.e. *green* or *yellow*). Color is a mandatory field in remark-map. To set the same *remark-codepoint* for a *match-codepoint*

irrespective of color, we have to set color as "all".

### **IPv4-ToS, IPv6-TC, or MPLS-EXP remarking:**

- If the *remark-codepoint* is not configured in the BA Classifier or there is no hit in MF Classifier, *match-codepoint* in the remark-map is the ToS/TC value of the incoming IP packet.
- If the *remark-codepoint* is configured in the BA Classifier and there is no hit in the MF Classifier, *match-codepoint* is the same value as the *remark-codepoint* in the BA Classifier
- Irrespective of the *remark-codepoint* configured in the BA Classifier, if there is a hit in the MF Classifier the *match-codepoint* is the same value as the action *remark-codepoint* (0 if no action *remark-codepoint* configured) in the MF Classifier.

### **IEEE 802.1p VLAN remarking:**



- Class-to-IP based Remark Map for L2TP UPSTREAM traffic is mapped globally. For more information, see the [L2TP QoS](#) section.
- In tunnel termination cases (i.e. Downstream traffic from core to Subscriber) the *remark-codepoint* in the MPLS BA Classifier is of no use. Therefore the *match\_codepoint* in remark-map at the egress shall be the ToS/TC value of the incoming IP packet.
- In IP tunnel encapsulation cases (i.e. L2TP Upstream traffic from Subscriber to core) the *remark-codepoint* in the IPv4-TOS BA Classifier is of no use. Therefore the *match\_codepoint* in class-to-ip remark-map at the egress shall be the Class derived from ingress BA Classifier.
- If no MPLS remarking is configured for the Upstream traffic, EXP bits in the MPLS header are derived from IP header TOS/TC bits using the Uniform MPLS mode.
- For VLAN: Only class to IEEE 802.1p remarking is supported.
- For IPv4: Only ToS based remarking is possible. DSCP-based remarking is not possible.
- For IPv6: Only TC based remarking is possible.



- The VLAN priority remarking support for the platforms is as follows:

**UfiSpace S9600-72XC:**

match-codepoint: Value of the IPv4-ToS/IPv6-TC in the incoming IP packet or the remark-codepoint configured in the BA/MF Classifier

remark-codepoint: Based on the VLAN priority

**Edgecore AS5916-54XKS:**

match-codepoint: MF or BA classifiers are used to determine class at the ingress

remark-codepoint: Based on the VLAN priority

**QAX Platform: UfiSpace S9500-22XST and Edgecore CSR320 (AS7316-26XB)**

In QAX platform, IP TOS to VLAN bits do not get directly mapped. The IP ToS is mapped to internal priority in classification, and then from internal priority VLAN priority bit remarking is performed.

- **IPv4/v6 and IEEE 802.1p** remark-map is applied on an interface - subscriber-ifl or l3ifl using Profile Name.
- **MPLS-IPv4/v6** remark-map is applied either globally or per-instance (to support multiple VPN marking schemes) using Remark-Map Name.

**L2BSA L2X VLAN Priority Remarking:**

The L2BSA L2X VLAN priority remarking support for the platforms is as follows: Only A10NSP switches support VLAN operations, access-leaf is transparent.

- Downstream Traffic (Remote ISP to Subscriber):

On A10NSP Switch:

The class derived from the VLAN Pbit Classifier is used to remark MPLS Exp and Outer VLAN IEEE-802.1 Pbit Value, inner VLAN Pbit is transparent.

On Q2C Access Leaf:

The received Outer VLAN IEEE-802.1 Pbit value is retained, explicit remarking at access-leaf is not supported.

- Upstream Traffic (Subscriber to Remote ISP):

On Q2C Access Leaf:

To remark the outgoing packet, global MPLS Exp remark map can be used.

On A10NSP Switch:

To remark the outgoing packet, VLAN IEEE-802.1 Pbit remark map can be used.

For more information about L2BSA configurations, see the [L2BSA User Guide](#).

### **L2VPN VLAN Manipulation QoS Remarking:**

- VLAN remarking allows for various VLAN manipulations (push, swap, push-push, swap-swap, swap-push) on the outer VLAN in double-tag or single-tag scenarios.
- VLAN remarking for VLAN manipulation involving POP operations (pop, pop-pop, pop-swap) is not supported.

## **Header Compensation**

### **Queue Compensation**

The rate at which the packets are dequeued from a queue depends on the credit received by that queue. The source of the credit received by a queue is the egress port to which the queue is mapped. When a packet is dequeued, the credit balance is decreased by the packet size. But, the packet size that is used must be adjusted to model the packet size at the egress, rather than its actual size at the ingress queue. Thus the header compensation is used to adjust for the differences in header size between ingress queue and egress port. RBFS supports static header compensation configuration per queue (in bytes).

### **Port Compensation**

Similar to queue header compensation where header compensation is performed at the per-queue level, RBFS supports the following header compensation at the per-port level:

- **Ingress Header Compensation:** In line with the header compensation option that we have per-queue, RBFS supports static header compensation configuration at the ingress to be used by the policing. Header compensation changes the effective size of the packet to compensate for changes in header size (such as the CRC removal) when considering the packet for policing. Unlike queue, RBFS ingress header compensation configuration is per ingress port (in bytes).
- **Egress Header Compensation:** In line with the header compensation option that we have per-queue or per-port at the ingress, RBFS supports static header compensation configuration at the egress. The egress header compensation configuration is per egress port (in bytes).



The supported range for header compensation is -64 to +64 bytes.

## L2TP QoS

The Layer 2 Tunneling Protocol (L2TP) QoS for upstream is similar to any other locally terminated subscriber. The QoS Profile is mapped dynamically via RADIUS for the L2TP subscribers.

The L2TP QoS for Downstream requires IPv4-TOS based BA Classifier which is mapped to L2TP Tunnel. The same can be achieved by attaching *l2tp-classifier-name* in *global QoS* configuration.

```
forwarding-options {
  class-of-service {
    global {
      l2tp-classifier-name l2tp-ip;
    }
  }
}
```

For Downstream queueing, there is no change. Queueing is applied using QoS Profile similar to locally terminated Subscribers.

The following features are supported for L2TP QoS.

- Upstream
  - BA Classifier: IEEE 802.1p
  - Policing
    - Policer statistics

## Remarking



- L2TP upstream traffic can be remarked by configuring remark-code-point in the classifier configuration.
- L2TP downstream traffic can be remarked by profile with the remark configuration. A match-codepoint value will be the class value derived from the l2tp-ip classifier.

- Downstream

BA Classifier: IPv4-TOS

Queueing/Scheduling/Shaping

Queue statistics

Remark-Map: IEEE 802.1p (Class to VLAN priority remarking)

## Guidelines

- To avoid control traffic policing/shaping, the assumption is that the IEEE 802.1p bits in Upstream or IPv4-TOS bits in Downstream will be different for control and data traffic, control traffic is expected to have the highest precedence.

Upstream classification is based on IEEE 802.1p bits.

Downstream classification is based on IPv4-TOS bits of the outer IP header.

- PBIT (IEEE-802.1p) classification and policing for the upstream traffic from IPE subscribers is not supported.
- Mark control plane traffic with codepoints based on protocols and layers (such as routing, signaling, and subscriber-management protocols, layer-2, layer-3) and ensure it is treated with higher priority.
- It is recommended to configure MFC (multi-field classifier) for the upstream classification for subscriber traffic.

# 13. Multi-level H-QoS : Level-1 to Level-5

A sample 5-level requirement looks like this.

## **Level-1 (IFP)**

Physical Interface Shaper.

## **Level-2 (PON TREE)**

Each PON tree is a TDM based shared medium with typically ~2.5 GBit/s (GPON) shared by up to 32 consumers (ONT or DPU).

## **Level-3 (DPU)**

In case of FTTB there is a single DPU with multiple consumers via G.Fast DSL connected which requires an additional hierarchy. This level is not needed for FTTH or FTTC.

## **Level-4 (ANP or Session)**

The Access Node Port (ANP) or outer VLAN level describes a single customer line. This might be an ONT in case of FTTH or DSL interface behind a DPU in case of FTTB. This level can be also represented on PPPoE sessions as long as just one session is permitted per VLAN.

## **Level-5 (QUEUE)**

The Queue level shaper is required to limit the class-of-service bandwidth like Voice or IPTV traffic limit.

The figure below shows the diagram along with QoS representing Level-1 to Level-5 Hierarchical scheduling.

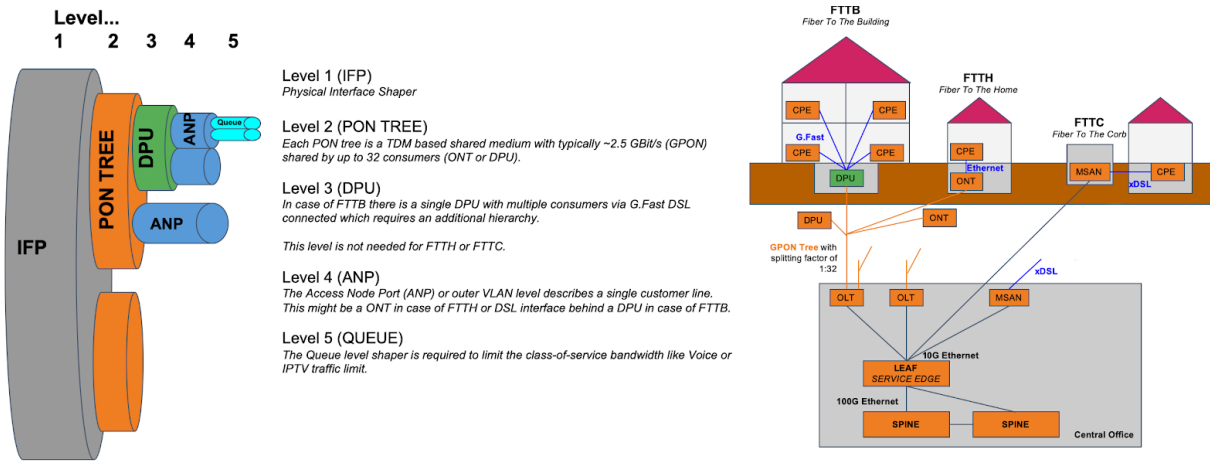

Levels 4 and 5 are configured per logical interface (i.e. subscriber-ifl or l3-ifl). Separate scheduler-map representing levels 1 to 3 connectivity shall be statically configured and mapped to the corresponding physical interface (IFP).

The child scheduler in a subscriber scheduler map is connected to the parent scheduler in a physical interface scheduler map using the following way:

- Dynamically via RADIUS in case of dynamic subscribers like PPPoE sessions (Subscriber-IFL).

The figure below shows the same details as the preceding figure before with the different levels but from the DPU-PON-IFP scheduler-map point of view.

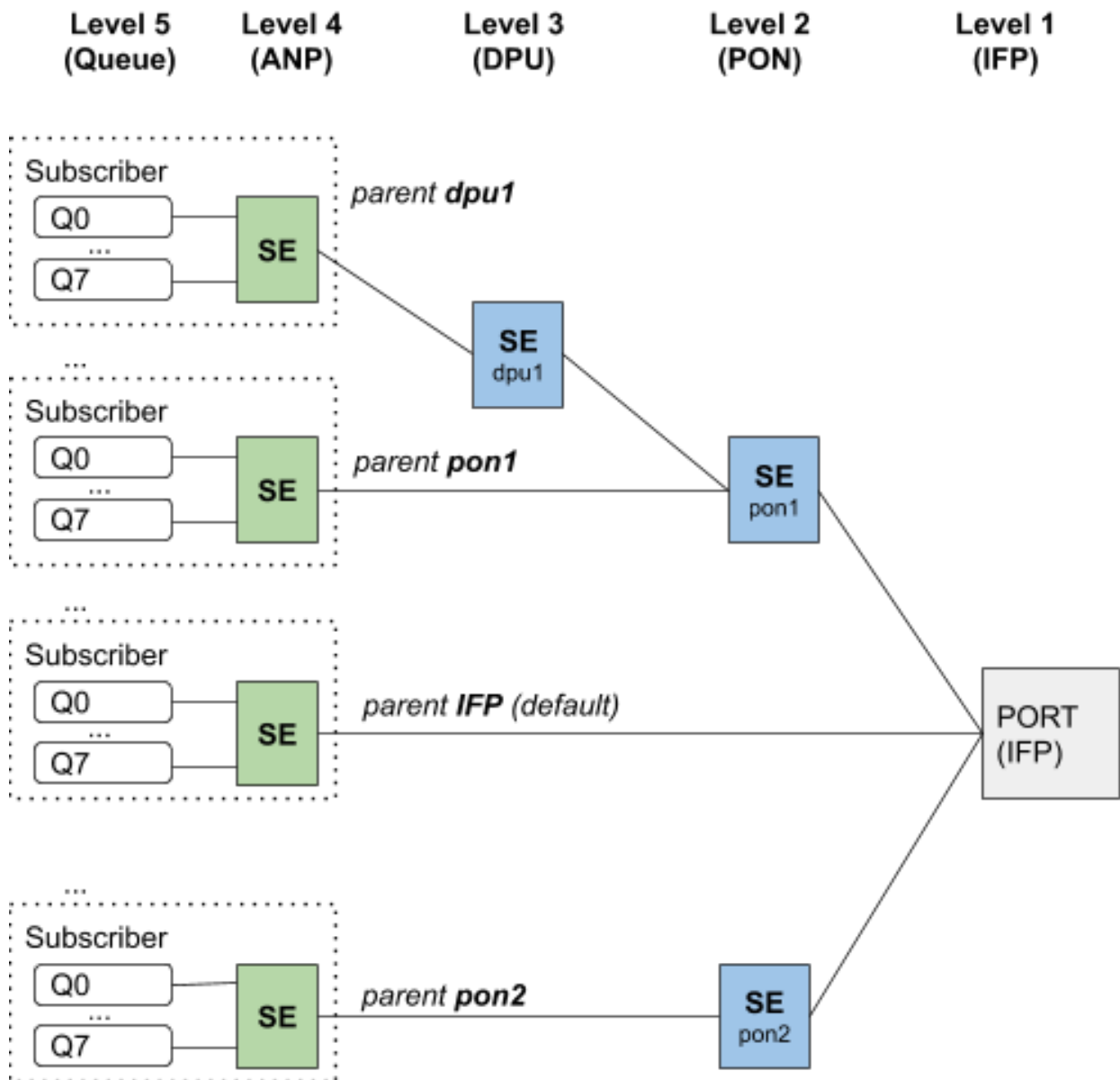

## QoS Support for L2 and L3 Logical Interfaces

QoS is supported on Layer 2 and Layer 3 logical interfaces.

## Support Interface-set for Grouping Logical Interfaces

An interface-set is a collection or group of logical interfaces (that is, L2 or L3) belonging to the same physical interface (IFP).

## QoS Support for Interface-set Hierarchy

QoS can be configured at the interface-set hierarchy (service-group), and the IFLs belonging to this interface-set must configure the service-group scheduler to connect to the PON scheduler or directly to the IFP.

## Business Service QoS

A business service can be leveraged using an interface-set. A business service comprises of a number of logical interfaces. QoS can be configured at the interface-set hierarchy (service-group) and at the logical interface level as well.

The logical-interface-scheduler is connected to an interface-set (business service group) scheduler and the interface-set-scheduler can be connected to a PON-scheduler or directly to a port-scheduler.

## MPLS HQoS

The MPLS HQoS has both UNIFORM and PIPE modes. These modes provide the following functionality:

- During MPLS Encapsulation, MPLS Mode is UNIFORM. MSB 3-bits from 8-bits IPv4-ToS or IPv6-TC are copied to the EXP bits of the newly added MPLS header(s).
- During MPLS Decapsulation, MPLS Mode is PIPE. 8-bit IPv4-ToS or IPv6-TC will be retained and hence it provides ToS/TC codepoint transparency.

For the Uniform MPLS mode mapping between IPv4-ToS or IPv6-TC to MPLS-EXP see the table below:

IPv4-TOS / IPv6-TC	EXP	DSCP
0-31	0	0-7
32-63	1	8-15
64-95	2	16-23
96-127	3	24-31
128-159	4	32-39
160-191	5	40-47
192-223	6	48-55
224-255	7	56-63

## Supported Platforms

Not all features are necessarily supported on each hardware platform. Refer to the



*Platform Guide* for the features and the sub-features that are or are not supported by each platform.

## 13.7. HQoS Configuration

### Basic QoS Configuration Elements

The figure below shows the dependencies between the various QoS configuration elements.

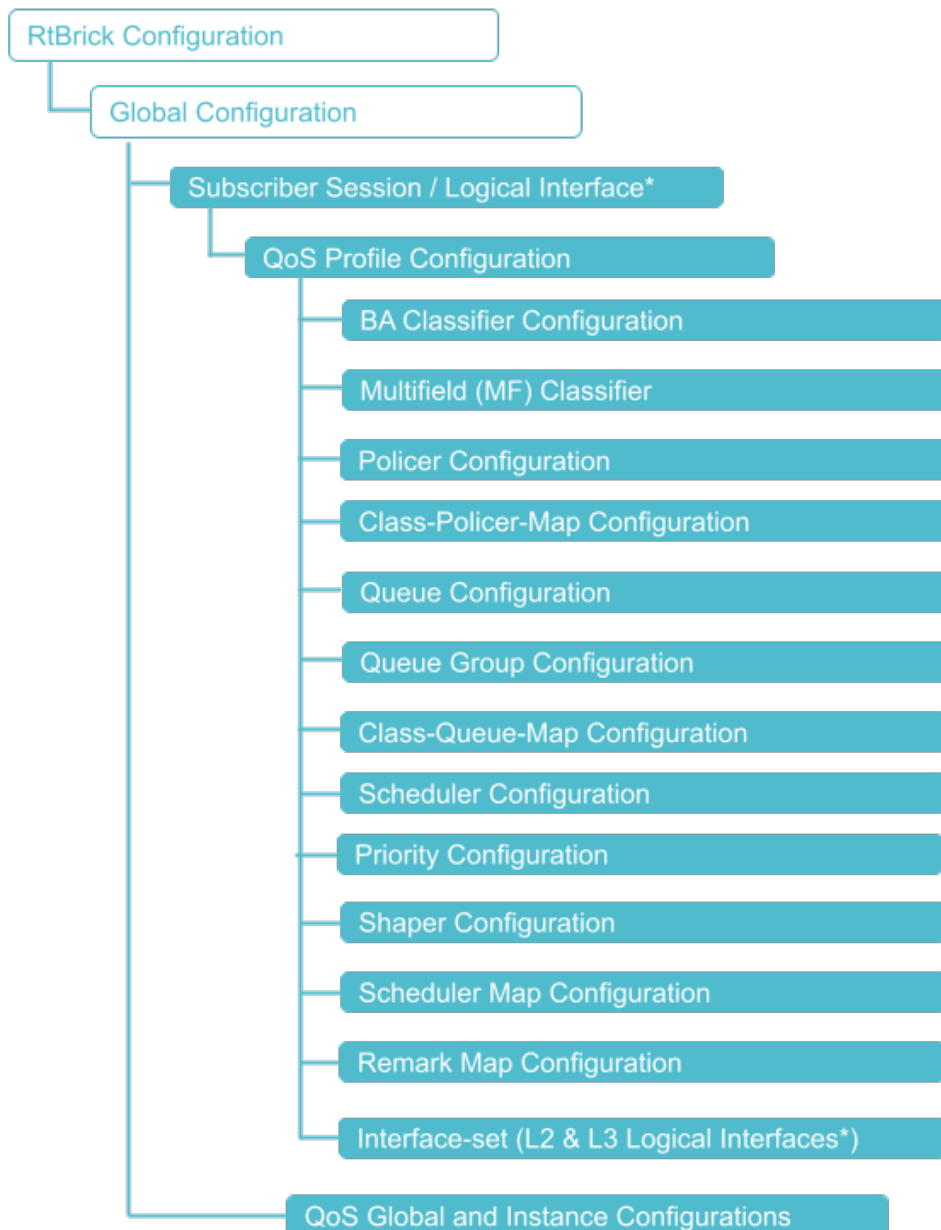

To configure QoS, perform the following steps which include creating a QoS profile and enabling QoS on a Subscriber-Interface or L3-Interface.

1. Define a QoS profile with classifier, multifeild-classifier, class-policer-map, policer, class-queue-map, scheduler-map, and remark-map based on SLAs.
2. Create a Behavioral Aggregate (BA) and/or Multifeild (MF) classifier to classify the network traffic at the ingress.
3. Create a policer to police the classified traffic at the ingress with the CIR/PIR defined.
4. Create necessary class-to-policer-map to map the classes to policer levels (mandatory for policing).
5. Create necessary queues with proper size to queue the classified traffic before egressing the traffic.
6. Create queue groups and define queue numbers (1/4/8).  
NOTE: For the system to initialize with a single queue in a Queue-Group, a system reboot is required.
7. Create the necessary class-to-queue map to map the classes to queues (mandatory for queuing).
8. Specify scheduler(s) with type as required.
9. (Optional) Create the shaper (low-flow / high-flow) and attach it to queue(s) and/or scheduler(s).
10. Specify a scheduler map to define a set of relationships between parent (scheduler or port) and child (queue/queue-group or scheduler) at the egress.
11. (optional) Create Remark-Map for QoS field remarking of the outgoing packet.
12. For the downstream traffic, map the MPLS EXP classifier either to an instance or global entity and/or the Multifeild (MF) classifier as a global entity (refer to the figure above.)
13. (optional) Map the MPLS-IPv4/IPv6 remark-map either to an instance or configure it as a global entity.
14. For business services QoS, service-group scheduler is connected to PON scheduler or directly to an IFP.



Priority propagation is enabled by default. To disable the Priority Propagation, we recommend doing this at the beginning and not during an active session.

## Hierarchical QoS

Basic Quality of Service (QoS) is designed to provide a single level of traffic scheduling. In contrast, Hierarchical Quality of Service (HQoS) offers a more sophisticated approach to traffic treatment, utilizing multiple levels of scheduling in a hierarchical manner based on Service Level Agreements (SLAs).

The figure below shows the additional dependencies for Multi-level HQoS.

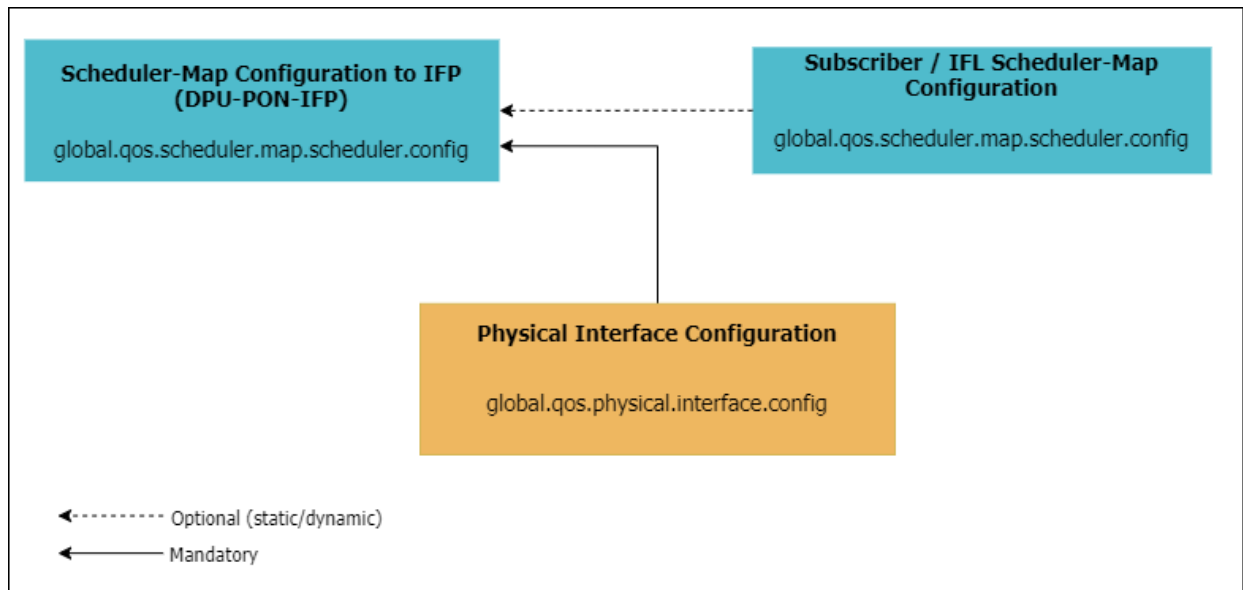

Below are the figures depicting an example of scheduling hierarchy.

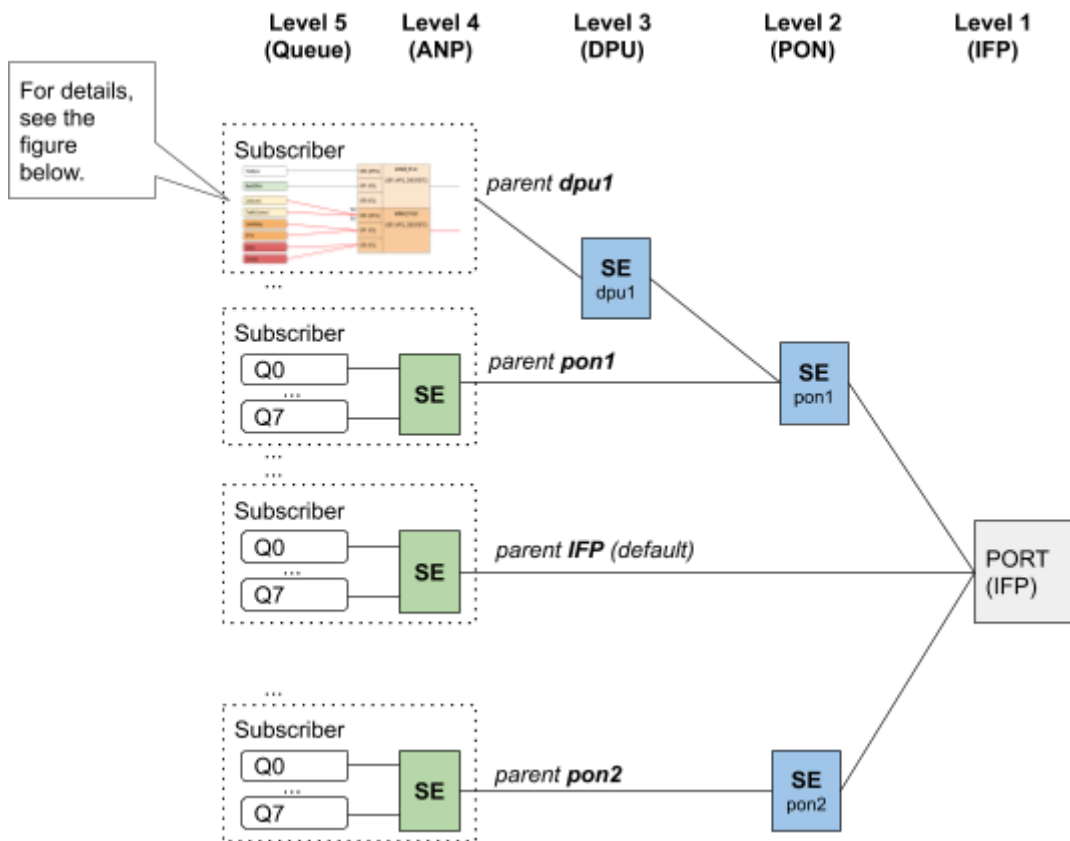

Priority Propagation Enabled  
Composite Type Enabled

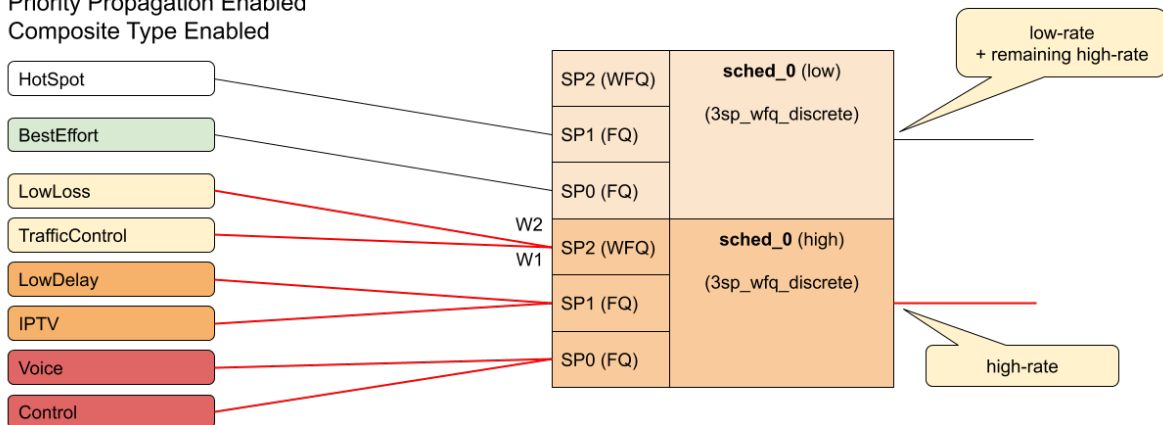

To configure HQoS, map the level-3 to level-5 hierarchy in multi-level HQoS to a different scheduler to represent it and map it to the physical interface.

### Configuration Syntax and Commands

The configurations in this section exemplify the setup of Hierarchical Quality of Service (HQoS) for a subscriber with a residential profile and a Service Level Agreement (SLA) of 20Mbps upstream and downstream. The setup also encompasses four different service types, namely Best Effort(BE), Low-Delay(LD), Low-Loss(LL) and Voice(VO). Different services are assigned to various policer

levels for upstream traffic based on their respective traffic classes. Meanwhile, for downstream traffic, these same services are assigned to different queues depending on their traffic class. The traffic class is determined by the configuration of either the BA or MF classifier.

The following sections describe the HQoS configuration syntax and commands.

- [Configuring QoS Profiles](#)
- [Behavior Aggregate \(BA\) Classifier Configuration](#)
- [Multifield Classifier \(MFC\) Configuration](#)
- [L2 ACL Priority Bit Egress Classifier Configuration](#)
- [Policer Configuration](#)
- [Class-Policer-Map Configuration](#)
- [Queue Configuration](#)
- [Queue-Group Configuration](#)
- [Class-Queue-Map Configuration](#)
- [Scheduler Configuration](#)
- [Shaper Configuration](#)
- [Scheduler-Map Configuration](#)
- [Remark-Map Configuration](#)

## 13.8. Configuring QoS Profiles

A profile configuration defines the QoS profile that is installed on the subscriber or L3 interfaces. The following sections explain the different elements of the QoS profiles that you can create and attach.

Use the following CLI syntax to configure a QoS profile:

```
set forwarding-options class-of-service profile <profile-name>  
<attribute> <value>
```

Attribute	Description
<profile-name>	Specifies the name of the QoS profile
classifier-name <classifier-name>	Specifies the name of the BA classifier
multifield-classifier-name <multifield-classifier-name>	Specifies the name of the multifield classifier
class-policer-map-name <class-policer-map-name>	Specifies the name of the map that associates a class with a policer level.
policer-name <policer-name>	Specifies the policer name
class-queue-map-name <class-queue-map-name>	Specifies the name of the map that associates a class with a queue
scheduler-map-name <scheduler-map-name>	Specifies the name of the scheduler map
remark-map-name <remark-map-name>	Specifies the name of the remark map
egress-class-policer-map-name <egress-class-policer-map-name>	Specifies the name of the egress Class Policer Map. This configuration applies only to the L2X traffic on the LAG interface.
egress-policer-name <egress-policer-name>	Specifies the name of the egress policer. This configuration applies only to the L2X traffic on the LAG interface.

In the following example, the QoS profile **residential** is configured with classifier-name **subs-pbit-class**, class-policer-map **policer-map-residential**, policer **policer-residential**, class-queue-map **subs-4queues**, scheduler-map **subs-4queues-residential**, and remark-map **subs-remark-residential**.

```

set forwarding-options class-of-service profile residential
set forwarding-options class-of-service profile residential classifier-name subs-pbit-class
set forwarding-options class-of-service profile residential class-queue-map-name subs-4queues
set forwarding-options class-of-service profile residential remark-map-name subs-remark-residential
set forwarding-options class-of-service profile residential policer-name policer-residential
set forwarding-options class-of-service profile residential class-policer-map-name policer-map-residential
set forwarding-options class-of-service profile residential scheduler-map-name subs-4queues-residential
commit
    
```

The following example shows the QoS profile configuration of the **residential**

profile:

```

supervisor@rtbrick>LEAF01: cfg> show config forwarding-options class-of-service profile
{
  "rtbrick-config:profile": [
    {
      "profile-name": "residential",
      "classifier-name": "subs-pbit-class",
      "class-queue-map-name": "subs-4queues",
      "remark-map-name": "subs-remarking-residential",
      "policer-name": "policer-residential",
      "class-policer-map-name": "policer-map-residential",
      "scheduler-map-name": "subs-4queues-residential"
    }
  ]
}
supervisor@rtbrick>LEAF01: cfg>
    
```

## Behavior Aggregate (BA) Classifier Configuration

Use the following CLI syntax to configure the BA classifier:

```

set forwarding-options class-of-service classifier <classifier-name>
<attribute> <value>
    
```

Attribute	Description
<classifier-name>	Specifies the classifier name
match-type <match-type>	Specifies the type of traffic to classify, that is, ipv4-tos, ipv6-tc, ieee-802.1, exp
match-type <match-type> codepoint <codepoint>	Specifies the code-point value based on the match-type
match-type <match-type> codepoint <codepoint> class <class>	Specifies the traffic class as class-0, class-1, class-2, class-3, class-4, class-5, class-6, and class-7
match-type <match-type> codepoint <codepoint> remark-codepoint <remark-codepoint>	Specifies the remark-codepoint that is used for remarking

The following example configures the BA classifier **subs-pbit-class** for traffic **ieee-802.1** with a match code point **2** classified as class **class-1**.

```
set forwarding-options class-of-service classifier subs-pbit-class match-type ieee-802.1 codepoint 2 class
class-1
commit
```

The following example shows BA classifier configuration.

```
supervisor@rtbrick>LEAF01: cfg> show config forwarding-options class-of-service classifier
{
  "rtbrick-config:classifier": [
    {
      "classifier-name": "subs-pbit-class",
      "match-type": [
        {
          "match-type": "ieee-802.1",
          "codepoint": [
            {
              "codepoint": 2,
              "class": "class-1"
            }
          ]
        }
      ]
    }
  ]
}
supervisor@rtbrick>LEAF01: cfg>
```

### Multifield Classifier (MFC) Configuration

Use the following CLI syntax to configure the multifield classifier.

```
set forwarding-options class-of-service multifield-classifier <attribute>
<value>
```



Starting from Release 20.10.2, Multifield Classifier configuration requires explicit use of ordinal keywords.

Attribute	Description
acl <l3v4   l3v6> <...>	Specifies the l3v4 / l3v6 ACL rule for multifield classifier configurations. For more information on configuring the ACL match rules, see the sections below.

### IPv4 ACL Configuration Configuration

Use the following CLI syntax to configure the IPv4 ACL Match Configuration for the



multifield classifier:

```
set forwarding-options class-of-service multifield-classifier acl I3v4 rule
<rule-name> ordinal <ordinal-value> <attribute> <Value>
```

Attribute	Description
<rule-name>	Specifies the multifield classifier rule name
ordinal <ordinal-value>	Specifies the ordinal that is used for traffic policy rule referencing
match <destination-ipv4-prefix>	Specifies the destination IPv4 prefix address
match <destination-ipv4-prefix-list>	Specifies the destination IPv4 prefix list name
match <direction>	Specifies the acl I3 traffic direction match
match <ip-protocol>	Specifies the IP protocol such as UDP or TCP
match <destination-l4-port>	Specifies the Layer 4 destination port number
match <ipv4-tos>	Specifies the IPv4 ToS value
match <ipv4-dscp>	Specifies the IPv4 Differentiated Services Code Point (DSCP) value
match <forward-class>	Specifies the forward class name
match <mpls-traffic>	Specifies the MPLS traffic
match <source-ipv4-prefix>	Specifies the source IPv4 prefix address
match <source-ipv4-prefix-list>	Specifies the source IPv4 prefix list name
match <source-l4-port>	Specifies the Layer 4 source port number
action forward-class <class>	class-0, class-1, class-2, class-3, class-4, class-5, class-6, class-7
action remark-codepoint <remark-codepoint>	Specifies the remark-map codepoint value

Multifield classification commonly matches on IP address fields, the IP protocol

type field, or the port number in the UDP or TCP pseudo-header field.

The **l3v4** acl-type multifield classifier is configured with a qualifier/match based on **ipv4-tos** (128, 160) and **source-ipv4-prefix** (132.1.1.3/32) with action as **forward-class** (class-0,class-1).

```
set forwarding-options class-of-service multifield-classifier acl l3v4 rule global_mfc
set forwarding-options class-of-service multifield-classifier acl l3v4 rule global_mfc ordinal 1001
set forwarding-options class-of-service multifield-classifier acl l3v4 rule global_mfc ordinal 1001 match
  ipv4-tos 128
set forwarding-options class-of-service multifield-classifier acl l3v4 rule global_mfc ordinal 1001 match
  source-ipv4-prefix 132.1.1.3/32
set forwarding-options class-of-service multifield-classifier acl l3v4 rule global_mfc ordinal 1001 action
  forward-class class-0
set forwarding-options class-of-service multifield-classifier acl l3v4 rule global_mfc ordinal 1002
set forwarding-options class-of-service multifield-classifier acl l3v4 rule global_mfc ordinal 1002 match
  ipv4-tos 160
set forwarding-options class-of-service multifield-classifier acl l3v4 rule global_mfc ordinal 1002 match
  source-ipv4-prefix 132.1.1.3/32
set forwarding-options class-of-service multifield-classifier acl l3v4 rule global_mfc ordinal 1002 action
  forward-class class-1
commit
```

The following example shows the IPv4 Match Configuration for the multifield classifier:

```
supervisor@rtbrick>C-BNG.rtbrick.net: cfg> show config forwarding-options class-of-service multifield-
classifier acl l3v4 rule global_mfc
{
  "rtbrick-config:rule": [
    {
      "rule-name": "global_mfc",
      "ordinal": [
        {
          "ordinal-value": 1001,
          "match": {
            "ipv4-tos": 128,
            "source-ipv4-prefix": "132.1.1.3/32"
          },
          "action": {
            "forward-class": "class-0"
          }
        },
        {
          "ordinal-value": 1002,
          "match": {
            "ipv4-tos": 160,
            "source-ipv4-prefix": "132.1.1.3/32"
          },
          "action": {
            "forward-class": "class-1"
          }
        }
      ]
    }
  ]
}
```

## IPv6 ACL Configuration Configuration

Use the following CLI syntax to configure the IPv6 ACL match configuration for the

multifield classifier:

```
set forwarding-options class-of-service multifield-classifier acl I3v6 rule
<rule-name> ordinal <ordinal-value> <attribute> <value>
```

Attribute	Description
<rule-name>	Specifies the multifield classifier rule name
ordinal <ordinal-value>	Specifies the ordinal that is used for traffic rule referencing
match <destination-ipv6-prefix>	Specifies the destination IPv6 prefix address
match <destination-ipv6-prefix-list>	Specifies the destination IPv6 prefix list name
match <ip-protocol>	Specifies the IP protocol such as UDP or TCP
match <destination-l4-port>	Specifies the Layer 4 destination port number
match <ipv6-tc>	Specifies the IPv6 traffic class value
match <forward-class>	Specifies the forward class name
match <mpls-traffic>	Specifies the MPLS traffic
match <source-ipv6-prefix>	Specifies the source IPv6 prefix address
match <source-ipv6-prefix-list>	Specifies the source IPv6 prefix list name
match <source-l4-port>	Specifies the Layer 4 source port number
action forward-class <class>	class-0, class-1, class-2, class-3, class-4, class-5, class-6, class-7
action remark-codepoint <remark-codepoint>	Specifies the remark-map codepoint value

In the following example, the **I3v6** acl-type multifield classifier is configured with qualifier/match based on **ipv6-tc** (128, 160) and **source-ipv6-prefix** (132:1:1::3/32) with action as **forward-class** (class-0,class-1).

```

set forwarding-options class-of-service multifield-classifier acl l3v6 rule global_mfc
set forwarding-options class-of-service multifield-classifier acl l3v6 rule global_mfc ordinal 1001
set forwarding-options class-of-service multifield-classifier acl l3v6 rule global_mfc ordinal 1001 match
ipv6-tc 128
set forwarding-options class-of-service multifield-classifier acl l3v6 rule global_mfc ordinal 1001 match
source-ipv6-prefix 132::1::3/32
set forwarding-options class-of-service multifield-classifier acl l3v6 rule global_mfc ordinal 1001 action
forward-class class-0
set forwarding-options class-of-service multifield-classifier acl l3v6 rule global_mfc ordinal 1002
set forwarding-options class-of-service multifield-classifier acl l3v6 rule global_mfc ordinal 1002 match
ipv6-tc 160
set forwarding-options class-of-service multifield-classifier acl l3v6 rule global_mfc ordinal 1002 match
source-ipv6-prefix 132:1:1::3/32
set forwarding-options class-of-service multifield-classifier acl l3v6 rule global_mfc ordinal 1002 action
forward-class class-1
commit
    
```

The following example shows the IPv6 match configuration for the multifield classifier:

```

supervisor@rtbrick>C-BNG.rtbrick.net: cfg> show config forwarding-options class-of-service multifield-
classifier acl l3v6 rule global_mfc
{
  "rtbrick-config:rule": [
    {
      "rule-name": "global_mfc",
      "ordinal": [
        {
          "ordinal-value": 1001,
          "match": {
            "ipv6-tc": 128,
            "source-ipv6-prefix": "132:1:1::3/32"
          },
          "action": {
            "forward-class": "class-0"
          }
        },
        {
          "ordinal-value": 1002,
          "match": {
            "ipv6-tc": 160,
            "source-ipv6-prefix": "132:1:1::3/32"
          },
          "action": {
            "forward-class": "class-1"
          }
        }
      ]
    }
  ]
}
    
```

## IPv4/IPv6 Priority Configuration

Use the following CLI syntax to configure the IPv4/IPv6 priority configuration:

```

set forwarding-options class-of-service multifield-classifier acl [I3v4 | I3v6] rule <rule-name> <attribute> <value>
    
```

Attribute	Description
<rule-name>	Specifies the multifielid classifier rule name
ordinal <ordinal-value>	Specifies the ordinal that is used for traffic policy rule referencing
ordinal <ordinal-value> <priority>	Specify the ACL priority value. Range: 0 - 65535.

The following example configures the **l3v6** acl-type multifielid classifier with qualifier/match based on **ipv6-tc** (128) and **source-ipv6-prefix**(132:1:1::3/32) with action as **forward-class** (class-0,class-1) along with **priority** value (100, 200). When there are multiple qualifiers or actions, the one with the higher priority takes precedence over the others.

```

set forwarding-options class-of-service multifielid-classifier acl l3v6 rule global_mfc
set forwarding-options class-of-service multifielid-classifier acl l3v6 rule global_mfc ordinal 1001
set forwarding-options class-of-service multifielid-classifier acl l3v6 rule global_mfc ordinal 1001 match
ipv6-tc 128
set forwarding-options class-of-service multifielid-classifier acl l3v6 rule global_mfc ordinal 1001 match
source-ipv6-prefix 132::1:1:3/32
set forwarding-options class-of-service multifielid-classifier acl l3v6 rule global_mfc ordinal 1001 priority
100
set forwarding-options class-of-service multifielid-classifier acl l3v6 rule global_mfc ordinal 1001 action
forward-class class-0
set forwarding-options class-of-service multifielid-classifier acl l3v6 rule global_mfc ordinal 1002
set forwarding-options class-of-service multifielid-classifier acl l3v6 rule global_mfc ordinal 1002 match
ipv6-tc 128
set forwarding-options class-of-service multifielid-classifier acl l3v6 rule global_mfc ordinal 1002 match
source-ipv6-prefix 132:1:1::3/32
set forwarding-options class-of-service multifielid-classifier acl l3v6 rule global_mfc ordinal 1002 priority
200
set forwarding-options class-of-service multifielid-classifier acl l3v6 rule global_mfc ordinal 1002 action
forward-class class-1
commit
    
```

The following example shows the IPv4 priority configuration:

```

supervisor@rtbrick>LEAF01: cfg> show config forwarding-options class-of-service multifielid-classifier acl
l3v4 rule rtb_mfc

supervisor@rtbrick>C-BNG.rtbrick.net: cfg> show config forwarding-options class-of-service multifielid-
classifier acl l3v6 rule global_mfc
{
  "rtbrick-config:rule": [
    {
      "rule-name": "global_mfc",
      "ordinal": [
        {
          "ordinal-value": 1001,
          "priority": 100,
          "match": {
            "ipv6-tc": 128,
            "source-ipv6-prefix": "132:1:1::3/32"
          },
          "action": {
            "forward-class": "class-0"
          }
        }
      ]
    }
  ],
}
    
```

```

    {
      "ordinal-value": 1002,
      "priority": 200,
      "match": {
        "ipv6-tc": 160,
        "source-ipv6-prefix": "132:1:1::3/32"
      },
      "action": {
        "forward-class": "class-1"
      }
    }
  ]
}
supervisor@rtbrick>LEAF01: cfg>

```

### 13.8.1. L2 ACL Priority Bit Egress Classifier Configuration

Use the following CLI syntax to configure the L2 ACL priority bit egress classifier.

**set forwarding-options** <attribute> <value>

Attribute	Description
acl l2 <...>	Specifies the L2 ACL rule for egress priority bit classifier configurations. For more information on configuring the ACL match rules, see the sections below.

#### Service VLAN Priority Configuration

Use the following CLI syntax to configure the L2 ACL Match Configuration for the egress priority bit classifier:

**set forwarding-options acl l2 rule** <rule-name> ordinal <ordinal-value> <attribute> <Value>

Attribute	Description
<rule-name>	Specifies the L2 ACL classifier rule name
ordinal <ordinal-value>	Specifies the ordinal that is used for traffic rule referencing
match <direction>	Specifies the direction of L2 traffic

Attribute	Description
match <service-outer-vlan-priority>	Specifies the outer VLAN priority of the L2 service traffic
action forward-class <class>	class-0, class-1, class-2, class-3, class-4, class-5, class-6, class-7

L2 ACL classification commonly matches on layer-2 fields such as service-inner-vlan-priority, service-outer-vlan-priority, interface-meta-data, and direction

The l2 acl type egress priority bit classifier is configured with a qualifier/match based on service-inner-vlan-priority ` (0-7), interface-meta-data (type-1), direction (ingress), **service-outer-vlan-priority** (0-7) with action as **forward-class** (class-0 to class-7).

```

set forwarding-options acl 12 rule evpn_vpws ordinal 0
set forwarding-options acl 12 rule evpn_vpws ordinal 0 match direction ingress
set forwarding-options acl 12 rule evpn_vpws ordinal 0 match service-outer-vlan-priority 0
set forwarding-options acl 12 rule evpn_vpws ordinal 0 match interface-meta-data type-1
set forwarding-options acl 12 rule evpn_vpws ordinal 0 action forward-class class-0
set forwarding-options acl 12 rule evpn_vpws ordinal 1
set forwarding-options acl 12 rule evpn_vpws ordinal 1 match direction ingress
set forwarding-options acl 12 rule evpn_vpws ordinal 1 match service-outer-vlan-priority 1
set forwarding-options acl 12 rule evpn_vpws ordinal 1 match interface-meta-data type-1
set forwarding-options acl 12 rule evpn_vpws ordinal 1 action forward-class class-1
commit

```

The following example shows the L2 ACL P-Bit Egress Classifier configuration:

```

supervisor@rtbrick>C-BNG.rtbrick.net: cfg> show config forwarding-options acl 12 rule evpn_vpws ordinal
{
  "rtbrick-config:ordinal": [
    {
      "ordinal-value": 0,
      "match": {
        "direction": "ingress",
        "service-outer-vlan-priority": 0,
        "interface-meta-data": "type-1"
      },
      "action": {
        "forward-class": "class-0"
      }
    },
    {
      "ordinal-value": 1,
      "match": {
        "direction": "ingress",
        "service-outer-vlan-priority": 1,
        "interface-meta-data": "type-1"
      },
      "action": {
        "forward-class": "class-1"
      }
    }
  ]
}
1

```

}

## 13.8.2. Policer Configuration

Use the following CLI syntax to configure the QoS policer:

```
set forwarding-options class-of-service policer <policer-name> <attribute>
<value>
```

Attribute	Description
<policer-name>	Specifies the policer name.
<levels>	Specifies levels in the policer. There is only support for the policer levels 1 and 4.
<type>	Specifies the policer type.
<flag>	Specifies the policer flags.
level1-rates cir <cir>	Specifies the committed information rate (CIR) in Kilobits per second (Kbps) for level-1. The same is applicable for level-2 to level-4.
level1-rates pir <pir>	Specifies the peak information rate (PIR) in Kilobits per second (Kbps) for level-1. The same is applicable for level-2 to level-4.
level1-rates cbs <cbs>	Specifies the Committed burst size (CBS) in Kilobits per second (Kbps) for level-1. The same is applicable for level-2 to level-4.
level1-rates pbs <pbs>	Specifies the peak burst size (PBS) in Kilobits per second (Kbps) for level-1. The same is applicable for level-2 to level-4.
level1-rates max-cir <max-cir>	Specifies the maximum for the level-1 committed information rate (CIR) in kilobits per second (Kbps). The same is applicable for level-2 to level-4.
level1-rates max-pir <max-pir>	Specifies the maximum for the level-1 peak information rate (PIR) in Kilobits per second (Kbps). The same is applicable for level-2 to level-4.

The following example configures the QoS policer **policer-residential** with multi-



level policers (levels=4), CIR, PIR rates, and burst sizes (CBS, PBS) for each level (level-1, level-2, level-3 and level-4). Also, **two-rate-three-color** policer type and color-blind as the default configuration. The four-level Policer configuration is as follows:

- Level-1(cir=2Mbps, pir=2.5Mbps, cbs=1000, pbs=1000)
- Level-2(cir=3Mbps, pir=3.5Mbps, cbs=1000, pbs=1000)
- Level-3(cir=4Mbps, pir=4.5Mbps, cbs=1000, pbs=1000)
- Level-4(cir=1Mbps, pir=1.5Mbps, cbs=1000, pbs=1000)

The following configurations show policer configurations for levels=4.

```
set forwarding-options class-of-service policer policer-residential
set forwarding-options class-of-service policer policer-residential level1-rates cir 2000
set forwarding-options class-of-service policer policer-residential level1-rates cbs 1000
set forwarding-options class-of-service policer policer-residential level1-rates pir 2500
set forwarding-options class-of-service policer policer-residential level1-rates pbs 1000
set forwarding-options class-of-service policer policer-residential level2-rates cir 3000
set forwarding-options class-of-service policer policer-residential level2-rates cbs 1000
set forwarding-options class-of-service policer policer-residential level2-rates pir 3500
set forwarding-options class-of-service policer policer-residential level2-rates pbs 1000
set forwarding-options class-of-service policer policer-residential level3-rates cir 4000
set forwarding-options class-of-service policer policer-residential level3-rates cbs 1000
set forwarding-options class-of-service policer policer-residential level3-rates pir 4500
set forwarding-options class-of-service policer policer-residential level3-rates pbs 1000
set forwarding-options class-of-service policer policer-residential level4-rates cir 1000
set forwarding-options class-of-service policer policer-residential level4-rates cbs 1000
set forwarding-options class-of-service policer policer-residential level4-rates pir 1500
set forwarding-options class-of-service policer policer-residential level4-rates pbs 1000
set forwarding-options class-of-service policer policer-residential levels 4
set forwarding-options class-of-service policer policer-residential type two-rate-three-color
commit
```

The following example shows the QoS policer level (levels=4) rates configuration:

```
supervisor@rtbrick>LEAF01: cfg> show config forwarding-options class-of-service policer policer-residential
{
  "rtbrick-config:policer": [
    {
      "policer-name": "policer-residential",
      "level1-rates": {
        "cir": 2000,
        "cbs": 1000,
        "pir": 2500,
        "pbs": 1000
      },
      "level2-rates": {
        "cir": 3000,
        "cbs": 1000,
        "pir": 3500,
        "pbs": 1000
      },
      "level3-rates": {
        "cir": 4000,
        "cbs": 1000,
        "pir": 4500,
```

```

        "pbs": 1000
    },
    "level4-rates": {
        "cir": 1000,
        "cbs": 1000,
        "pir": 1500,
        "pbs": 1000
    },
    "levels": 4,
    "type": "two-rate-three-color"
}
]
}

```

The following configurations show policer configurations for levels=1.

```

set forwarding-options class-of-service policer policer-residential
set forwarding-options class-of-service policer policer-residential level1-rates cir 2000
set forwarding-options class-of-service policer policer-residential level1-rates cbs 1000
set forwarding-options class-of-service policer policer-residential level1-rates pir 2500
set forwarding-options class-of-service policer policer-residential level1-rates pbs 1000
set forwarding-options class-of-service policer policer-residential levels 1
set forwarding-options class-of-service policer policer-residential type two-rate-three-color
commit

```

The following example shows the QoS policer level rates (levels=1) configuration:

```

supervisor@rtbrick>LEAF01: cfg> show config forwarding-options class-of-service policer policer-residential
{
  "rtbrick-config:policer": [
  {
    "policer-name": "policer-residential",
    "level1-rates": {
      "cir": 2000,
      "cbs": 1000,
      "pir": 2500,
      "pbs": 1000
    }
    "levels": 1,
    "type": "two-rate-three-color"
  }
  ]
}

```

### 13.8.3. Class-Policer-Map Configuration

Use the following CLI syntax to configure the Class-Policer-Map:

```

set forwarding-options class-of-service class-policer-map <class-policer-map-name> <attribute> <value>

```

Attribute	Description
<class-policer-map-name>	Specifies the class policer map name,

Attribute	Description
class <class>	Specifies the class such as class-0, class-1, class-2, class-3, class-4, class-5, class-6, class-7
class <class> <policer-level>	Specifies the policer levels. The supported levels are: level-1, level-2, level-3, and level-4

Below is an example configuration of the class-policer-map, which sets up level-1 to level-4 policer levels.

- class-0 mapped to policer level-1
- class-1 mapped to policer level-2
- class-2 mapped to policer level-3
- class-3 mapped to policer level-4

```
set forwarding-options class-of-service class-policer-map policer-map-residential class class-0 policer-level
level-1
set forwarding-options class-of-service class-policer-map policer-map-residential class class-1 policer-level
level-2
set forwarding-options class-of-service class-policer-map policer-map-residential class class-2 policer-level
level-3
set forwarding-options class-of-service class-policer-map policer-map-residential class class-3 policer-level
level-4
commit
```

The following example shows the class-policer-map configuration:

```
supervisor@rtbrick>LEAF01: cfg> show config forwarding-options class-of-service class-policer-map policer-
map-l2tp
{
  "rtbrick-config:class-policer-map": [
  {
    "class-policer-map-name": "policer-map-residential",
    "class": [
      {
        "class": "class-0",
        "policer-level": "level-1"
      },
      {
        "class": "class-1",
        "policer-level": "level-2"
      },
      {
        "class": "class-2",
        "policer-level": "level-3"
      },
      {
        "class": "class-3",
        "policer-level": "level-4"
      }
    ]
  }
]
}
supervisor@rtbrick>LEAF01: cfg>
```

### 13.8.4. Queue Configuration

Use the following CLI syntax to configure a queue:

```
set forwarding-options class-of-service queue <queue-name> <atribute>
<value>
```

Attribute	Description
<queue-name>	Specifies the queue name
queue-size <queue-size>	Specifies the size of the queue in bytes
<shaper-name>	(Optional) Specifies the shaper that is associated with the queue
wred minimum-threshold <minimum-threshold>	Specifies the minimum average queue size to apply WRED in bytes
wred maximum-threshold <maximum-threshold>	Specifies the maximum average queue size to apply WRED in bytes
wred drop-probability <drop-probability>	WRED drop probability applied at the maximum threshold
header-compensation bytes <bytes>	Specifies the header compensation value
header-compensation decrement true	Specifies whether the header compensation value is to be decremented.

The following example configures four queues with different traffic streams named **BE\_SUBS**, **LD\_SUBS**, **LL\_SUBS** and **VO\_SUBS** with queue attributes queue-size, queue header-compensation & queue shaper for Best Effort(BE), Low-Delay(LD), Low-Loss(LL) and Voice(VO) Queues.

```
set forwarding-options class-of-service queue BE_SUBS
set forwarding-options class-of-service queue BE_SUBS queue-size 375000
set forwarding-options class-of-service queue BE_SUBS header-compensation bytes 22
set forwarding-options class-of-service queue BE_SUBS header-compensation decrement true
set forwarding-options class-of-service queue LD_SUBS
set forwarding-options class-of-service queue LD_SUBS queue-size 625000
set forwarding-options class-of-service queue LD_SUBS header-compensation bytes 22
set forwarding-options class-of-service queue LD_SUBS header-compensation decrement true
set forwarding-options class-of-service queue LL_SUBS
set forwarding-options class-of-service queue LL_SUBS queue-size 625000
set forwarding-options class-of-service queue LL_SUBS header-compensation bytes 22
set forwarding-options class-of-service queue LL_SUBS header-compensation decrement true
```

```

set forwarding-options class-of-service queue VO_SUBS
set forwarding-options class-of-service queue VO_SUBS queue-size 156250
set forwarding-options class-of-service queue VO_SUBS header-compensation bytes 22
set forwarding-options class-of-service queue VO_SUBS header-compensation decrement true
set forwarding-options class-of-service queue VO_SUBS shaper-name shaper_VO
commit

```

The following example shows the queue configuration:

```

supervisor@DT-STD-23-2402>bml4-tst.fsn.rtrbrick.net: cfg> show config forwarding-options class-of-service
queue
{
  "rtbrick-config:queue": [
    {
      "queue-name": "BE_SUBS",
      "queue-size": 375000,
      "header-compensation": {
        "bytes": 22,
        "decrement": "true"
      }
    },
    {
      "queue-name": "LD_SUBS",
      "queue-size": 625000,
      "header-compensation": {
        "bytes": 22,
        "decrement": "true"
      }
    },
    {
      "queue-name": "LL_SUBS",
      "queue-size": 625000,
      "header-compensation": {
        "bytes": 22,
        "decrement": "true"
      }
    },
    {
      "queue-name": "VO_SUBS",
      "queue-size": 156250,
      "shaper-name": "shaper_VO",
      "header-compensation": {
        "bytes": 22,
        "decrement": "true"
      }
    }
  ]
}
supervisor@rtbrick>LEAF01: cfg>

```

## 13.8.5. Queue-Group Configuration

### Queue group size: 1 or 4 or 8

Use the following CLI syntax to configure a queue group:

```

set forwarding-options class-of-service queue-group <queue-group-
name> <attribute> <value>

```

Attribute	Description
<queue-group-name>	User-defined name for the queue-group
queue-numbers <queue-numbers>	Specifies the number of queues in a Queue Group

The following examples configure the queue group with queue numbers 1 and 4.

```
set forwarding-options class-of-service queue-group subs-4queues queue-numbers 1
commit
```

The following example shows the queue group configuration:

```
supervisor@rtbrick>LEAF01: cfg> show config forwarding-options class-of-service queue-group
{
  "rtbrick-config:queue-group": [
    {
      "queue-group-name": "subs-4queues",
      "queue-numbers": 1
    }
  ]
}
supervisor@rtbrick>LEAF01: cfg>
```

```
set forwarding-options class-of-service queue-group subs-4queues queue-numbers 4
```

The following example shows the queue group configuration:

```
supervisor@rtbrick>LEAF01: cfg> show config forwarding-options class-of-service queue-group
{
  "rtbrick-config:queue-group": [
    {
      "queue-group-name": "subs-4queues",
      "queue-numbers": 4
    }
  ]
}
supervisor@rtbrick>LEAF01: cfg>
```

## Class-Queue-Map Configuration

Use the following CLI syntax to configure the class-queue-map:

```
set forwarding-options class-of-service class-queue-map <class-queue-map-name> <attribute> <value>
```

Attribute	Description
<class-queue-map-name>	Specifies the class queue map name
class <class>	Specifies the class such as class-0, class-1, class-2, class-3, class-4, class-5, class-6, class-7
class <class> queue-name <queue-name>	Specifies the queue name

The following example configures the class-queue-map for the specific classes and queues:

- class-0 mapped to queue BE\_SUBS
- class-1 mapped to queue LD\_SUBS
- class-2 mapped to queue LL\_SUBS
- class-3 mapped to queue VO\_SUBS

```
set forwarding-options class-of-service class-queue-map subs-4queues class class-0 queue-name BE_SUBS
set forwarding-options class-of-service class-queue-map subs-4queues class class-1 queue-name LD_SUBS
set forwarding-options class-of-service class-queue-map subs-4queues class class-2 queue-name LL_SUBS
set forwarding-options class-of-service class-queue-map subs-4queues class class-3 queue-name VO_SUBS
commit
```

The following example shows the class-queue-map configuration:

```
supervisor@rtbrick>LEAF01: cfg> show config forwarding-options class-of-service class-queue-map
{
  "rtbrick-config:class-queue-map": [
  {
    "class-queue-map-name": "subs-4queues",
    "class": [
      {
        "class-type": "class-0",
        "queue-name": "BE_SUBS"
      },
      {
        "class-type": "class-1",
        "queue-name": "LD_SUBS"
      },
      {
        "class-type": "class-2",
        "queue-name": "LL_SUBS"
      },
      {
        "class-type": "class-3",
        "queue-name": "VO_SUBS"
      }
    ]
  }
]
```

```
supervisor@rtbrick>LEAF01: cfg>
```

### 13.8.6. Scheduler Configuration

Use the following CLI syntax to configure a scheduler:

```
set forwarding-options class-of-service scheduler <attribute> <value>
```

Attribute	Description
<scheduler-name>	User-defined Scheduler Name
<scheduler-name> shaper-name <shaper-name>	(Optional) User-defined Shaper Name
<scheduler-name> type <type>	Specifies the Scheduler Type 2sp_wfq_discrete 3sp_wfq_discrete strict_priority wfq_discrete_2sp 2sp_wfq_independent fair_queueing weighted_fair_queueing wfq_independent_2sp
<scheduler-name> composite true	(Optional) keyword to specify the scheduler as composite type

The following example configures two schedulers: **subs-4queues** with scheduler type **strict\_priority** for the Subscriber level, and **pon0** with scheduler type **fair\_queueing** for PON/GPON level.

```
set forwarding-options class-of-service scheduler subs-4queues
set forwarding-options class-of-service scheduler subs-4queues shaper shaper_session
set forwarding-options class-of-service scheduler subs-4queues type strict_priority
set forwarding-options class-of-service scheduler pon0
set forwarding-options class-of-service scheduler pon0 type fair_queueing
commit
```

The following example shows the QoS scheduler configuration:



```

supervisor@rtbrick>LEAF01: cfg> show config forwarding-options class-of-service scheduler
{
  "rtbrick-config:scheduler": [
    {
      "scheduler-name": "pon0",
      "type": "fair_queueing"
    },
    {
      "scheduler-name": "subs-4queues",
      "shaper-name": "shaper_session",
      "type": "strict_priority"
    }
  ]
}
supervisor@rtbrick>LEAF01: cfg>

```

## Priority Propagation

Use the following CLI syntax to configure priority propagation:

```
set forwarding-options class-of-service global priority-propagation
[enable | disable]
```

The following example enables priority propagation at the global level to operate schedulers in dual-flow mode, with high-priority and low-priority flows.

```
set forwarding-options class-of-service global priority-propagation enable
```

The following example shows the priority propagation:

```

supervisor@rtbrick>LEAF01: cfg> show config forwarding-options class-of-service global
{
  "rtbrick-config:global": {
    "priority-propagation": "enable"
  }
}

```

## 13.8.7. Shaper Configuration

Use the following CLI syntax to configure a shaper:

```
set forwarding-options class-of-service shaper <shaper-name> <attribute>
<value>
```

## Command Arguments

Attribute	Description
<shaper-name>	User-defined shaper name
<shaper-name> shaping-rate-high <0-700000000>	High flow shaping rate in kilobits per second
<shaper-name> shaping-rate-high-precision true	Configures the precision of high-flow shapers, which can only be used with session shapers.
<shaper-name> shaping-rate-low <0-700000000>	Low flow shaping rate in kilobits per second



- Low-rate shaping is only supported for high-priority flows. Enabling low-rate shaping consumes additional QoS resources, which will impact the scalability.
- If priority propagation is not enabled, high-flow shaping value will be considered for shaper.
- If the scheduler type is **strict\_priority**, the mapping of queues to priorities begins with **strict\_priority\_1**.

The following example configures the shaper high-flow and low-flow rates for Subscriber Session Level with shaper-name **shaper\_session** and Queue Level with shaper-name **shaper\_VO**.

```
set forwarding-options class-of-service shaper shaper_session
set forwarding-options class-of-service shaper shaper_session shaping-rate-high 10000
set forwarding-options class-of-service shaper shaper_session shaping-rate-low 100
set forwarding-options class-of-service shaper shaper_VO
set forwarding-options class-of-service shaper shaper_VO shaping-rate-high 2000
set forwarding-options class-of-service shaper shaper_VO shaping-rate-low 0
commit
```

The following example shows the shaper configuration:

```
supervisor@rtbrick>LEAF01: cfg> show config forwarding-options class-of-service shaper
{
  "rtbrick-config:shaper": [
    {
      "shaper-name": "shaper_VO",
```

```

        "shaping-rate-high": 2000,
        "shaping-rate-low": 0
    },
    {
        "shaper-name": "shaper_session",
        "shaping-rate-high": 10000,
        "shaping-rate-low": 100
    }
]
}
supervisor@rtbrick>LEAF01: cfg>

```

With the following shaper configuration, the low flow is limited to 1Mbps and the high flow is limited to 512Kbps. This results in a session rate of approximately 1.5Mbps when 10Mbps is distributed between high and low flows.

```

set forwarding-options class-of-service shaper session-shaper
set forwarding-options class-of-service shaper session-shaper shaping-rate-high-precision true
set forwarding-options class-of-service shaper session-shaper shaping-rate-high 512
set forwarding-options class-of-service shaper session-shaper shaping-rate-low 1000

```

The following example shows the shaper configuration, where the high precision shaping is enabled:

```

{
  "rtbrick-config:shaper": [
    {
      "shaper-name": "session-shaper",
      "shaping-rate-high": 512,
      "shaping-rate-high-precision": "true",
      "shaping-rate-low": 1000
    }
  ]
}

```

### 13.8.8. Scheduler-Map Configuration

Use the following CLI syntax to configure a Scheduler-Map:

```

set forwarding-options class-of-service scheduler-map <scheduler-map-name> <attribute> <value>

```

## Command arguments

Attribute	Description
<scheduler-map-name>	Specifies the name of the scheduler-map
scheduler-name <scheduler-name>	Specifies the name of the scheduler
queue-group-name <group-name>	Specifies the name of the queue-group
queue-group-name <group-name> queue-name <name>	Specifies the name of the queue
queue-group-name <group-name> queue-name <name> connection-point <connection-point>	Specifies the type of connection point, such as no_priority, strict_priority_0, strict_priority_1, strict_priority_2, strict_priority
queue-group-name <group-name> queue-name <name> parent-flow <high-flow / low-flow>	(Optional) Specifies the type of the parent flow, that is high-flow or low-flow.
queue-group-name <group-name> queue-name <name> parent-scheduler-name <parent-scheduler-name>	Specifies the name of the parent scheduler

Attribute	Description
queue-group-name <group-name> queue-name <name> port-connection	<port-connection-type>
Specifies the type of port connection, that is, queue_to_port or scheduler_to_port	queue-group-name <group-name> queue-name <name> weight <weight>

The following example configures a scheduler map for OLT with `schedmap-olt` and for subscribers with `subs-4queues-residential`. OLT scheduler-map `schedmap-olt` is directly connected to the physical port and `subs-4queues-residential` connects different queues (BE\_SUBS, LL\_SUBS, LD\_SUBS, VO\_SUBS) with different connection-points (`strict_priority_3`, `strict_priority_2`, `strict_priority_1`, `strict_priority_0`).

```

set forwarding-options class-of-service scheduler-map schedmap-olt
set forwarding-options class-of-service scheduler-map schedmap-olt scheduler-name pon0
set forwarding-options class-of-service scheduler-map schedmap-olt scheduler-name pon0 port-connection
scheduler_to_port
set forwarding-options class-of-service scheduler-map subs-4queues-residential
set forwarding-options class-of-service scheduler-map subs-4queues-residential queue-group-name subs-4queues
set forwarding-options class-of-service scheduler-map subs-4queues-residential queue-group-name subs-4queues
queue-name BE_SUBS
set forwarding-options class-of-service scheduler-map subs-4queues-residential queue-group-name subs-4queues
queue-name BE_SUBS parent-flow high-flow
set forwarding-options class-of-service scheduler-map subs-4queues-residential queue-group-name subs-4queues
queue-name BE_SUBS parent-scheduler-name subs-4queues
set forwarding-options class-of-service scheduler-map subs-4queues-residential queue-group-name subs-4queues
queue-name BE_SUBS connection-point strict_priority_3
set forwarding-options class-of-service scheduler-map subs-4queues-residential queue-group-name subs-4queues
queue-name LD_SUBS
set forwarding-options class-of-service scheduler-map subs-4queues-residential queue-group-name subs-4queues
queue-name LD_SUBS parent-flow high-flow
set forwarding-options class-of-service scheduler-map subs-4queues-residential queue-group-name subs-4queues
queue-name LD_SUBS parent-scheduler-name subs-4queues
set forwarding-options class-of-service scheduler-map subs-4queues-residential queue-group-name subs-4queues
queue-name LD_SUBS connection-point strict_priority_1
set forwarding-options class-of-service scheduler-map subs-4queues-residential queue-group-name subs-4queues
queue-name LL_SUBS
set forwarding-options class-of-service scheduler-map subs-4queues-residential queue-group-name subs-4queues
queue-name LL_SUBS parent-flow high-flow
set forwarding-options class-of-service scheduler-map subs-4queues-residential queue-group-name subs-4queues
queue-name LL_SUBS parent-scheduler-name subs-4queues
set forwarding-options class-of-service scheduler-map subs-4queues-residential queue-group-name subs-4queues
queue-name LL_SUBS connection-point strict_priority_2
set forwarding-options class-of-service scheduler-map subs-4queues-residential queue-group-name subs-4queues
queue-name VO_SUBS
set forwarding-options class-of-service scheduler-map subs-4queues-residential queue-group-name subs-4queues
queue-name VO_SUBS parent-flow high-flow
set forwarding-options class-of-service scheduler-map subs-4queues-residential queue-group-name subs-4queues
queue-name VO_SUBS parent-scheduler-name subs-4queues
set forwarding-options class-of-service scheduler-map subs-4queues-residential queue-group-name subs-4queues
queue-name VO_SUBS connection-point strict_priority_0
set forwarding-options class-of-service scheduler-map subs-4queues-residential scheduler-name subs-4queues
    
```

```
set forwarding-options class-of-service scheduler-map subs-4queues-residential scheduler-name subs-4queues
port-connection scheduler_to_port
commit
```

The following example shows the scheduler-map configuration:

```
supervisor@rtbrick>LEAF01: cfg> show config forwarding-options class-of-service scheduler-map
{
  "rtbrick-config:scheduler-map": [
  {
    "scheduler-map-name": "schedmap-olt",
    "scheduler-name": [
      {
        "name": "pon0",
        "port-connection": "scheduler_to_port"
      }
    ]
  },
  {
    "scheduler-map-name": "subs-4queues-residential",
    "queue-group-name": [
      {
        "group-name": "subs-4queues",
        "queue-name": [
          {
            "name": "BE_SUBS",
            "parent-flow": "high-flow",
            "parent-scheduler-name": "subs-4queues",
            "connection-point": "strict_priority_3"
          },
          {
            "name": "LD_SUBS",
            "parent-flow": "high-flow",
            "parent-scheduler-name": "subs-4queues",
            "connection-point": "strict_priority_1"
          },
          {
            "name": "LL_SUBS",
            "parent-flow": "high-flow",
            "parent-scheduler-name": "subs-4queues",
            "connection-point": "strict_priority_2"
          },
          {
            "name": "VO_SUBS",
            "parent-flow": "high-flow",
            "parent-scheduler-name": "subs-4queues",
            "connection-point": "strict_priority_0"
          }
        ]
      }
    ]
  },
  {
    "scheduler-name": [
      {
        "name": "subs-4queues",
        "port-connection": "scheduler_to_port"
      }
    ]
  }
]
}
```

## Remark-Map Configuration

Use the following CLI syntax to configure the remark-map:

```
set forwarding-options class-of-service remark-map <remark-map-name> <attribute> <value>
```

## Command arguments

Attribute	Description
<remark-map-name>	Specifies the remarking map name.
remark-type <remark-type>	Specifies the remarking type - ipv4-tos, ipv6-tc, mpls-ipv4, mpls-ipv6, ieee-802.1, class-to-ip, ip-tos.  The "ip-tos" remark-type can be used to set the IPv4 ToS or IPv6 TC values in IPv4 or IPv6 packet header respectively.
remark-type <remark-type> <match-codepoint>	Specifies the match code point for the specified remarking type.   On the UfiSpace S9600-72XC and UfiSpace S9600-32X platforms, the match codepoint is TOS for VLAN IEEE-802.1p remarking.
remark-type <remark-type> <match-codepoint> color <color>	Indicates the color - all, green, yellow. Color is used to set different remark codepoints for the same match-codepoint based on color marked by the Policer.
remark-type <remark-type> <match-codepoint> color <color> remark-codepoint <remark-codepoint>	Specifies the remarking codepoint

In the following example, the remark map **subs-remarking-residential** is configured with match-codepoint as **128, 160, 192, and 224**. The color is set to "all", and the

## remark-codepoint is 6.

```

set forwarding-options class-of-service remark-map subs-remarking-residential
set forwarding-options class-of-service remark-map subs-remarking-residential remark-type ieee-802.1
set forwarding-options class-of-service remark-map subs-remarking-residential remark-type ieee-802.1 match-
codepoint 128
set forwarding-options class-of-service remark-map subs-remarking-residential remark-type ieee-802.1 match-
codepoint 128 color all
set forwarding-options class-of-service remark-map subs-remarking-residential remark-type ieee-802.1 match-
codepoint 128 color all remark-codepoint 6
set forwarding-options class-of-service remark-map subs-remarking-residential remark-type ieee-802.1 match-
codepoint 160
set forwarding-options class-of-service remark-map subs-remarking-residential remark-type ieee-802.1 match-
codepoint 160 color all
set forwarding-options class-of-service remark-map subs-remarking-residential remark-type ieee-802.1 match-
codepoint 160 color all remark-codepoint 6
set forwarding-options class-of-service remark-map subs-remarking-residential remark-type ieee-802.1 match-
codepoint 192
set forwarding-options class-of-service remark-map subs-remarking-residential remark-type ieee-802.1 match-
codepoint 192 color all
set forwarding-options class-of-service remark-map subs-remarking-residential remark-type ieee-802.1 match-
codepoint 192 color all remark-codepoint 6
set forwarding-options class-of-service remark-map subs-remarking-residential remark-type ieee-802.1 match-
codepoint 224
set forwarding-options class-of-service remark-map subs-remarking-residential remark-type ieee-802.1 match-
codepoint 224 color all
set forwarding-options class-of-service remark-map subs-remarking-residential remark-type ieee-802.1 match-
codepoint 224 color all remark-codepoint 6
commit

```

The following example shows the remark map configuration:

```

supervisor@rtbrick>LEAF01: cfg> show config forwarding-options class-of-service remark-map remark-exp remark-
type ipv6-tc
{
  "rtbrick-config:remark-type": [
  {
    "remark-map-name": "subs-remarking-residential",
    "remark-type": [
      {
        "remark-type": "ieee-802.1",
        "match-codepoint": [
          {
            "match-codepoint": 128,
            "color": [
              {
                "color": "all",
                "remark-codepoint": 6
              }
            ]
          },
          {
            "match-codepoint": 160,
            "color": [
              {
                "color": "all",
                "remark-codepoint": 6
              }
            ]
          },
          {
            "match-codepoint": 192,
            "color": [
              {
                "color": "all",
                "remark-codepoint": 6
              }
            ]
          }
        ]
      },
      {

```



```

    "match-codepoint": 224,
    "color": [
      {
        "color": "all",
        "remark-codepoint": 6
      }
    ]
  ]
}
supervisor@rtbrick>LEAF01: cfg>

```

## Global Profile Mapping

Use the following CLI syntax to configure the remark map for a global profile.

```

set forwarding-options class-of-service global remark-map-name
<remark-map-name>

```

## Command arguments

Attribute	Description
<remark-map-name>	Specifies the name of the remark map.

The following example configures the remark map for a global profile:

```

set forwarding-options class-of-service global remark-map-name subs-remarking-residential

```

The following example shows the remark map for a global profile configuration:

```

supervisor@rtbrick>LEAF01: cfg> show config forwarding-options class-of-service global
{
  "rtbrick-config:global": {
    "multifield-classifier-name": "global_mfc",
    "remark-map-name": "subs-remarking-residential"
  }
}
supervisor@rtbrick>LEAF01: cfg>

```

## Remark-map to Instance Mapping

Use the following CLI syntax to configure the remark map for an instance.

```
set forwarding-options class-of-service instance <instance-name>
remark-map-name <remark-map-name>
```

## Command arguments

Attribute	Description
<instance-name>	Specifies the name of the instance.
<remark-map-name>	Specifies the name of the remark map.

The following example configures the remark map for the instance **default**.

```
set forwarding-options class-of-service instance default remark-map-name subs-remarking-residential
commit
```

The following example shows the remark map configuration for the instance **default**.

```
supervisor@rtbrick>LEAF01: cfg> show config forwarding-options class-of-service instance default
{
  "rtbrick-config:instance": [
    {
      "name": "default",
      "remark-map-name": "subs-remarking-residential"
    }
  ]
}
supervisor@rtbrick>LEAF01: cfg>
```

## Configuring QoS L2 and L3 Logical Interfaces

### QoS Configuration

To support QoS on L2 logical interface, the class-of-service profile configuration is introduced. If a L2 logical interface is part of an interface-set, logical-interface scheduler/shaper must have parent-scheduler as interface-set-scheduler/shaper.

```
set interface ifp-0/0/16 unit 201
set interface ifp-0/0/16 unit 201 interface-type l2vpn-vpws
set interface ifp-0/0/16 unit 201 instance evpn-vpws-vrf2
set interface ifp-0/0/16 unit 201 vlan 200
set interface ifp-0/0/16 unit 201 inner-vlan 201
set interface ifp-0/0/16 unit 201 class-of-service qos_profile_service_1
```

```

set interface ifp-0/0/16 unit 202
set interface ifp-0/0/16 unit 202 interface-type l2vpn-vpws
set interface ifp-0/0/16 unit 202 instance evpn-vpws-vrf2
set interface ifp-0/0/16 unit 202 vlan 200
set interface ifp-0/0/16 unit 202 inner-vlan 202
set interface ifp-0/0/16 unit 202 class-of-service qos_profile_service_2
set interface ifp-0/0/16 unit 203
set interface ifp-0/0/16 unit 203 interface-type l2vpn-vpws
set interface ifp-0/0/16 unit 203 instance evpn-vpws-vrf2
set interface ifp-0/0/16 unit 203 vlan 200
set interface ifp-0/0/16 unit 203 inner-vlan 203
set interface ifp-0/0/16 unit 203 class-of-service qos_profile_service_3

```

## Interface-set Configuration

```

set interface-set service-group-1 interface ifp-0/0/16
set interface-set service-group-1 interface ifp-0/0/16 unit 201
set interface-set service-group-1 interface ifp-0/0/16 unit 202
set interface-set service-group-1 interface ifp-0/0/16 unit 203

```

## Combining Multiple Logical Interfaces with an Added QoS Hierarchy

### Configuring QoS Profile for a Logical Interface or Service

```

set forwarding-options class-of-service profile qos_profile_service_1
set forwarding-options class-of-service profile qos_profile_service_1 classifier-name upstream_pbit_classifier
set forwarding-options class-of-service profile qos_profile_service_1 class-queue-map-name
business_service_class_queue_map
set forwarding-options class-of-service profile qos_profile_service_1 class-policer-map-name
business_service_class_policer_map
set forwarding-options class-of-service profile qos_profile_service_1 policer-name business_service_policer_1
set forwarding-options class-of-service profile qos_profile_service_1 scheduler-map-name
business_service_scheduler_map_1

```

### Configuring QoS Profile for a Logical Interface Set

```

set forwarding-options class-of-service profile qos_profile_service_group
set forwarding-options class-of-service profile qos_profile_service_group scheduler-map-name
business_service_group_scheduler_map

```

### Enabling QoS Profile for a Logical Interface Set

```

set interface-set service-group-1
set interface-set service-group-1 class-of-service qos_profile_service_group
set forwarding-options class-of-service profile service-group-profile
set forwarding-options class-of-service profile service-group-profile class-queue-map-name subs-4queues
set forwarding-options class-of-service profile service-group-profile class-policer-map-name policer-map-
residential
set forwarding-options class-of-service profile service-group-profile policer-name policer-residential
set forwarding-options class-of-service profile service-group-profile scheduler-map-name
business_service_group_scheduler_map

```

The following CLIs are used to configure scheduler port connection to link schedulers across different scheduler maps:

QoS Scheduler-map to connect logical interface scheduler with interface-set scheduler:

```

set forwarding-options class-of-service scheduler-map schedmap_service_1
set forwarding-options class-of-service scheduler-map schedmap_service_1 scheduler-name sch_service_1
set forwarding-options class-of-service scheduler-map schedmap_service_1 scheduler-name sch_service_1 port-
connection scheduler-map-to-scheduler-map
set forwarding-options class-of-service scheduler-map schedmap_service_1 scheduler-name
business_service_scheduler_1 parent-scheduler-name business_service_group_scheduler
    
```

### QoS Scheduler-map to Connect an interface-set scheduler with a pon scheduler

```

set forwarding-options class-of-service scheduler-map business_service_group_scheduler_map
set forwarding-options class-of-service scheduler-map business_service_group_scheduler_map scheduler-name
business_service_group_scheduler
set forwarding-options class-of-service scheduler-map business_service_group_scheduler scheduler-name
business_service_group_scheduler parent-scheduler-name pon0
set forwarding-options class-of-service scheduler-map business_service_group_scheduler_map scheduler-name
business_service_group_scheduler port-connection scheduler_map_to_scheduler_map
    
```

## QoS Global and Instance Configurations

The figure below shows the dependencies for per instance or global classifier and remark-map configurations.

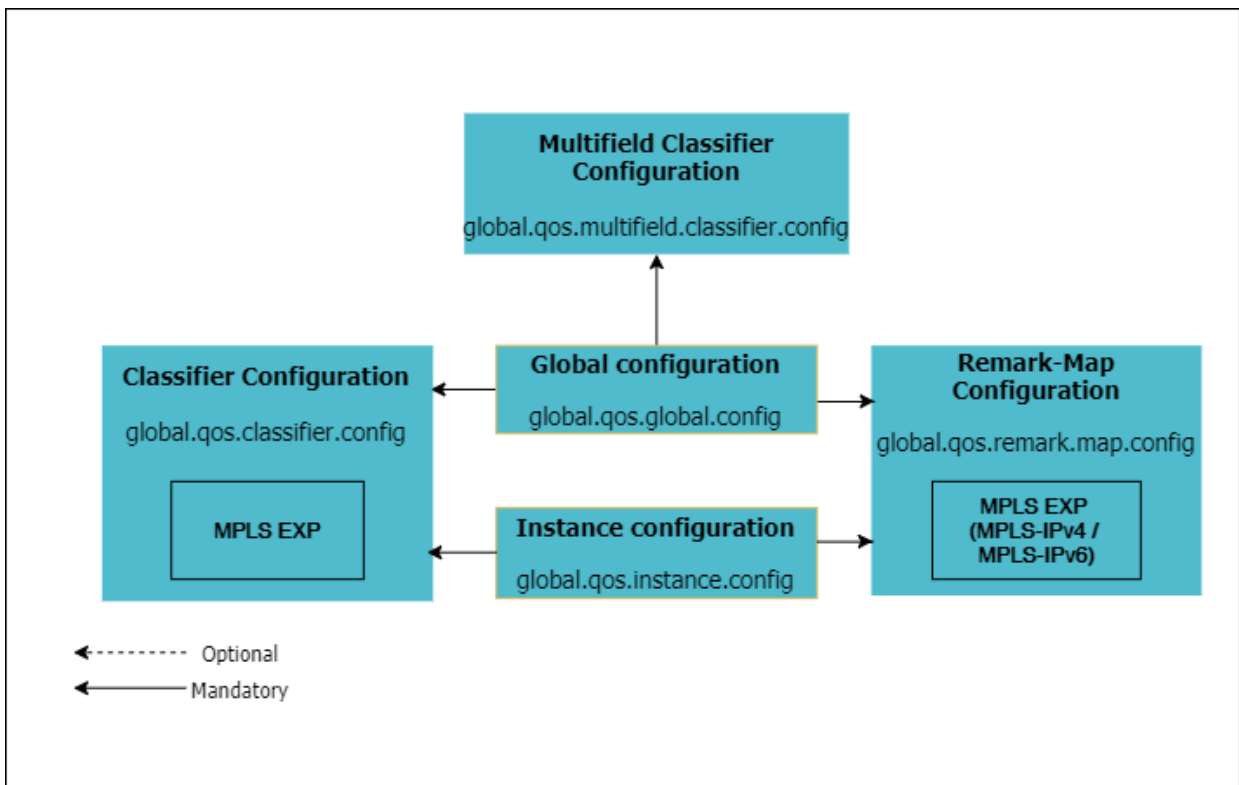

The following example configures the BA classifier `subs-exp-class` for traffic `exp` with match code point `2` classified as class `class-1`.

```
set forwarding-options class-of-service classifier subs-exp-class match-type exp codepoint 2 class class-1
```

## BA Classifier to Global Mapping

The MPLS classifiers can be applied globally using global configuration.

```
set forwarding-options class-of-service global classifier-name <classifier-name>
```

Attribute	Description
<classifier-name>	Specifies the classifier name

The following example shows how to configure the `subs-exp-class` BA Classifier for global mapping.

```
set forwarding-options class-of-service global classifier-name subs-exp-class
```

The configuration for global mapping to the BA Classifier is shown in the following example.

```
supervisor@rtbrick>LEAF01: cfg> show config forwarding-options class-of-service global classifier-name
{
  "rtbrick-config:classifier-name": "subs-exp-class"
}
supervisor@rtbrick>LEAF01: cfg>
```

## Single Queue To Global Mapping

The Single-Queue can be enabled with global configuration.



For the system to initialize with a single queue in a Queue-Group, a system reboot is required.

```
set forwarding-options class-of-service global queue-group-profile single-queue
```

Attribute	Description
-----------	-------------

The following example shows how to enable single-queue in a Queue-Group.

```
set forwarding-options class-of-service global queue-group-profile single-queue
commit
```

The configuration for a single queue in Queue-Group is shown in the following example.

```
supervisor@rtbrick>LEAF01: cfg> show config forwarding-options class-of-service global
{
  "rtbrick-config:global": {
    "queue-group-profile": "single-queue"
  }
}
supervisor@rtbrick>LEAF01: cfg>
```

### Remark-Map To Global Mapping

Use the following CLI syntax to configure the remark map for a global profile.

```
set forwarding-options class-of-service global remark-map-name
<remark-map-name>
```

### Command arguments

Attribute	Description
<remark-map-name>	Specifies the name of the remark map.

The following example configures the remark map for a global profile:

```
set forwarding-options class-of-service global remark-map-name subs-remarking-residential
commit
```

### Multifield Classifier (MFC) to Global Mapping

Use the following CLI syntax to configure the MF Classifier to Global Mapping:

```
set forwarding-options class-of-service global multifiel-d-classifier-name
<multifiel-d-classifier-name>
```

Attribute	Description
<multifiel-d-classifier-name>	Specifies the name of the multifiel classifier

The following example configures the multifiel Classifier to Global Mapping:

```
set forwarding-options class-of-service global multifiel-d-classifier-name global_mfc
commit
```

The following example shows the multifiel classifier to Global Mapping configuration:

```
supervisor@rtbrick>LEAF01: cfg> show config forwarding-options class-of-service global
{
  "rtbrick-config:global": {
    "multifiel-d-classifier-name": "global_mfc"
  }
}
supervisor@rtbrick>LEAF01: cfg>
```

### BA Classifier to Instance Mapping

The MPLS classifiers can be applied at an instance level using instance configuration.

```
set forwarding-options class-of-service instance <instance> classifier-name
<classifier-name>
```

Attribute	Description
<instance>	Specifies the instance name
<classifier-name>	Specifies the classifier name

The following example shows how to configure the **subs-exp-class** BA Classifier for the instance **default**.

```
set forwarding-options class-of-service instance default classifier-name subs-exp-class
commit
```

The configuration for instance mapping to the BA Classifier is shown in the following example.

```
supervisor@rtbrick>LEAF01: cfg> show config forwarding-options class-of-service instance default
{
  "rtbrick-config:instance": [
    {
      "name": "default",
      "classifier-name": "subs-exp-class"
    }
  ]
}
supervisor@rtbrick>LEAF01: cfg>
```

### Remark-Map To Instance Mapping

Use the following CLI syntax to configure the remark map for an instance.

```
set forwarding-options class-of-service instance <instance-name>
remark-map-name <remark-map-name>
```

### Command arguments

Attribute	Description
<instance-name>	Specifies the name of the instance.
<remark-map-name>	Specifies the name of the remark map.

The following example configures the remark map for the instance **default**:

```
set forwarding-options class-of-service instance default remark-map-name subs-remarking-residential
commit
```

The configuration for the remark map for an instance is shown in the following example.

```
supervisor@rtbrick>LEAF01: cfg> show config forwarding-options class-of-service instance default
{
  "rtbrick-config:instance": [
    {
```



```

    "name": "default",
    "remark-map-name": "subs-remarking-residential"
  }
]
}
supervisor@rtbrick>LEAF01: cfg>

```

## 13.8.9. HQoS Show Running-Configuration

To display the running configuration, use the **show config** command.

### Syntax

#### show config

### Example

```

supervisor@rtbrick>LEAF01: cfg> show config forwarding-options
"rtbrick-config:forwarding-options": {
  "mirror": [
    {
      "name": "m1",
      "destination": {
        "interface": "cpu-0/0/200"
      },
      "source": {
        "direction": "ingress",
        "interface": "ifp-0/1/30"
      }
    }
  ],
  "class-of-service": {
    "classifier": [
      {
        "classifier-name": "subs-pbit-class",
        "match-type": [
          {
            "match-type": "ieee-802.1",
            "codepoint": [
              {
                "codepoint": 1,
                "class": "class-0",
                "remark-codepoint": 7
              },
              {
                "codepoint": 2,
                "class": "class-1",
                "remark-codepoint": 7
              },
              {
                "codepoint": 3,
                "class": "class-2",
                "remark-codepoint": 7
              }
            ]
          }
        ]
      }
    ]
  }
}

```

```
        "codepoint": 4,
        "class": "class-3",
        "remark-codepoint": 7
      }
    ]
  }
},
"class-policer-map": [
  {
    "class-policer-map-name": "policer-map-residential",
    "class": [
      {
        "class": "class-0",
        "policer-level": "level-1"
      },
      {
        "class": "class-1",
        "policer-level": "level-2"
      },
      {
        "class": "class-2",
        "policer-level": "level-3"
      },
      {
        "class": "class-3",
        "policer-level": "level-4"
      }
    ]
  }
],
"class-queue-map": [
  {
    "class-queue-map-name": "subs-4queues",
    "class": [
      {
        "class-type": "class-0",
        "queue-name": "BE_SUBS"
      },
      {
        "class-type": "class-1",
        "queue-name": "LD_SUBS"
      },
      {
        "class-type": "class-2",
        "queue-name": "LL_SUBS"
      },
      {
        "class-type": "class-3",
        "queue-name": "VO_SUBS"
      }
    ]
  }
],
"global": {
  "multifield-classifier-name": "global_mfc"
},
"policer": [
  {
    "policer-name": "policer-residential",
```

```

    "level1-rates": {
      "cir": 2000,
      "cbs": 1000,
      "pir": 2500,
      "pbs": 1000
    },
    "level2-rates": {
      "cir": 3000,
      "cbs": 1000,
      "pir": 3500,
      "pbs": 1000
    },
    "level3-rates": {
      "cir": 4000,
      "cbs": 1000,
      "pir": 4500,
      "pbs": 1000
    },
    "level4-rates": {
      "cir": 1000,
      "cbs": 1000,
      "pir": 1500,
      "pbs": 1000
    },
    "levels": 4,
    "type": "two-rate-three-color"
  }
],
"profile": [
  {
    "profile-name": "residential",
    "classifier-name": "subs-pbit-class",
    "class-queue-map-name": "subs-4queues",
    "remark-map-name": "subs-remarking-residential",
    "class-policer-map-name": "policer-map-residential",
    "policer-name": "policer-residential",
    "scheduler-map-name": "subs-4queues-residential"
  }
],
"queue": [
  {
    "queue-name": "BE_SUBS",
    "queue-size": 375000
  },
  {
    "queue-name": "LD_SUBS",
    "queue-size": 625000
  },
  {
    "queue-name": "LL_SUBS",
    "queue-size": 625000
  },
  {
    "queue-name": "VO_SUBS",
    "queue-size": 156250,
    "shaper-name": "shaper_VO"
  }
],
"queue-group": [
  {
    "queue-group-name": "subs-4queues",

```

```

    "queue-numbers": 4
  }
],
"remark-map": [
  {
    "remark-map-name": "subs-remarking-residential",
    "remark-type": [
      {
        "remark-type": "ieee-802.1",
        "match-codepoint": [
          {
            "match-codepoint": 128,
            "color": [
              {
                "color": "all",
                "remark-codepoint": 6
              }
            ]
          },
          {
            "match-codepoint": 160,
            "color": [
              {
                "color": "all",
                "remark-codepoint": 6
              }
            ]
          },
          {
            "match-codepoint": 192,
            "color": [
              {
                "color": "all",
                "remark-codepoint": 6
              }
            ]
          },
          {
            "match-codepoint": 224,
            "color": [
              {
                "color": "all",
                "remark-codepoint": 6
              }
            ]
          }
        ]
      }
    ]
  }
],
"scheduler": [
  {
    "scheduler-name": "pon0",
    "shaper-name": "gpon-shaper",
    "type": "fair_queueing"
  },
  {
    "scheduler-name": "subs-4queues",
    "shaper-name": "shaper_session",
    "type": "strict_priority",

```

```

    "composite": "false"
  }
],
"scheduler-map": [
  {
    "scheduler-map-name": "schedmap-olt",
    "scheduler-name": [
      {
        "name": "pon0",
        "port-connection": "scheduler_to_port"
      }
    ]
  },
  {
    "scheduler-map-name": "subs-4queues-residential",
    "queue-group-name": [
      {
        "group-name": "subs-4queues",
        "queue-name": [
          {
            "name": "BE_SUBS",
            "parent-flow": "high-flow",
            "parent-scheduler-name": "subs-4queues",
            "connection-point": "strict_priority_3"
          },
          {
            "name": "LD_SUBS",
            "parent-flow": "high-flow",
            "parent-scheduler-name": "subs-4queues",
            "connection-point": "strict_priority_1"
          },
          {
            "name": "LL_SUBS",
            "parent-flow": "high-flow",
            "parent-scheduler-name": "subs-4queues",
            "connection-point": "strict_priority_2"
          },
          {
            "name": "VO_SUBS",
            "parent-flow": "high-flow",
            "parent-scheduler-name": "subs-4queues",
            "connection-point": "strict_priority_0"
          }
        ]
      }
    ]
  }
],
"scheduler-name": [
  {
    "name": "subs-4queues",
    "port-connection": "scheduler_to_port"
  }
]
},
"shaper": [
  {
    "shaper-name": "shaper_VO",
    "shaping-rate-high": 2000,
    "shaping-rate-low": 0
  },
  {

```

```

        "shaper-name": "shaper_session",
        "shaping-rate-high": 10000,
        "shaping-rate-low": 100
    },
    {
        "shaper-name": "gpon-shaper",
        "shaping-rate-high": 2488000,
        "shaping-rate-low": 32000
    }
],
"multifield-classifier": {
    "acl": {
        "13v4": {
            "rule": [
                {
                    "rule-name": "global_mfc",
                    "ordinal": [
                        {
                            "ordinal-value": 1001,
                            "match": {
                                "ipv4-tos": 128,
                                "source-ipv4-prefix": "192.0.2.2/32"
                            },
                            "action": {
                                "forward-class": "class-0"
                            }
                        },
                        {
                            "ordinal-value": 1002,
                            "match": {
                                "ipv4-tos": 160,
                                "source-ipv4-prefix": "192.0.2.2/32"
                            },
                            "action": {
                                "forward-class": "class-1"
                            }
                        },
                        {
                            "ordinal-value": 1003,
                            "match": {
                                "ipv4-tos": 192,
                                "source-ipv4-prefix": "192.0.2.2/32"
                            },
                            "action": {
                                "forward-class": "class-2"
                            }
                        },
                        {
                            "ordinal-value": 1004,
                            "match": {
                                "ipv4-tos": 224,
                                "source-ipv4-prefix": "192.0.2.2/32"
                            },
                            "action": {
                                "forward-class": "class-3"
                            }
                        }
                    ]
                }
            ]
        }
    }
}

```

```

    }
  }
}
    
```

## 13.8.10. HQoS Operational Commands

### HQoS Show Commands

The HQoS show commands provide detailed information about the HQoS operation.

#### show qos classifier

##### Syntax:

**show qos classifier** <option>

Option	Description
-	Without any option, this command displays a summary of all the classifiers.
<classifier-name>	Displays QoS classifier information for the specified classifier.

The following example displays a summary of all the HQoS classifiers.

```

supervisor@rtbrick>LEAF01: op> show qos classifier
Classifier: residential-ip-classifier
Active: False
  Match Type   Codepoint   Class      Remark Codepoint   Color
  ----
  ipv4-tos     0           class-0    -       -             -
  ipv4-tos     32          class-1    -       -             -
  ipv4-tos     64          class-2    -       -             -
  ipv4-tos     96          class-3    -       -             -
  ipv4-tos     128         class-4    -       -             -
  ipv4-tos     160         class-5    -       -             -
  ipv4-tos     192         class-6    -       -             -
  ipv4-tos     224         class-7    -       -             -
  ipv6-tc      0           class-0    -       -             -
  ipv6-tc      32          class-1    -       -             -
  ipv6-tc      64          class-2    -       -             -
  ipv6-tc      96          class-3    -       -             -
  ipv6-tc      128         class-4    -       -             -
  ipv6-tc      160         class-5    -       -             -
  ipv6-tc      192         class-6    -       -             -
  ipv6-tc      224         class-7    -       -             -
Classifier: residential-pbit-classifier
Active: True
    
```

Match Type	Codepoint	Class	Remark	Codepoint	Color
ieee-802.1	0	class-0	-		-
ieee-802.1	1	class-1	-		-
ieee-802.1	2	class-2	-		-
ieee-802.1	3	class-3	-		-
ieee-802.1	4	class-4	-		-
ieee-802.1	5	class-5	-		-
ieee-802.1	6	class-6	-		-
ieee-802.1	7	class-7	-		-

The following example displays information for the specified classifier.

```

supervisor@rtbrick>LEAF01: op> show qos classifier residential-pbit-classifier
Classifier: residential-pbit-classifier
Active: True
Match Type    Codepoint    Class      Remark Codepoint    Color
-----
ieee-802.1    0            class-0    -        -              -
ieee-802.1    1            class-1    -        -              -
ieee-802.1    2            class-2    -        -              -
ieee-802.1    3            class-3    -        -              -
ieee-802.1    4            class-4    -        -              -
ieee-802.1    5            class-5    -        -              -
ieee-802.1    6            class-6    -        -              -
ieee-802.1    7            class-7    -        -              -
    
```

### show qos interface

#### Syntax:

**show qos interface** <option>

Option	Description
-	Without any option, this command displays a summary of all the interfaces.
<interface-name>	Displays QoS classifier information for the specified interface.

The following example displays information for the specified interface.

```

supervisor@rtbrick>LEAF01: op> show qos interface ifl-0/0/10/200
Interface      Profile
ifl-0/0/10/200  pta_8queues_comp_on_S
supervisor@rtbrick>LEAF01: op>
    
```



## show qos policer

### Syntax:

**show qos policer** <option>

Option	Description
-	Without any option, this command displays a summary of all the QoS policers.
<policer-name>	Displays QoS policer information.
counter	Displays policer counter information.
class-to-policer-map	Displays class-to-policer-map information.

The following example displays a summary of all the QoS policers.

```

supervisor@rtbrick>LEAF01: op> show qos policer
Policer: _DEFAULT_POLICER_50_MB
Active: True, Type: two-rate-three-color, Levels: 1, Flags: -
  Level  CIR(Kbps)  PIR(Kbps)  CBS(KB)  PBS(KB)  Max CIR(Kbps)  Max PIR(Kbps)
  1      50000        50000      33000    33000    -              -
  2      -            -          -        -        -              -
  3      -            -          -        -        -              -
  4      -            -          -        -        -              -
Policer: policer-residential
Active: True, Type: two-rate-three-color, Levels: 4, Flags: -
  Level  CIR(Kbps)  PIR(Kbps)  CBS(KB)  PBS(KB)  Max CIR(Kbps)  Max PIR(Kbps)
  1      8000       8000      800      800      -              -
  2      -          -          -        -        -              -
  3      -          -          800     800      -              -
  4      -          -          800     800      -              -
    
```

The following example displays policer information for the specified policer.

```

supervisor@rtbrick>LEAF01: op> show qos policer policer-residential
Policer: policer-residential
Active: True, Type: two-rate-three-color, Levels: 4, Flags: -
  Level  CIR(Kbps)  PIR(Kbps)  CBS(KB)  PBS(KB)  Max CIR(Kbps)  Max PIR(Kbps)
  1      8000       8000      800      800      -              -
  2      -          -          -        -        -              -
  3      -          -          800     800      -              -
  4      -          -          800     800      -              -
supervisor@rtbrick>LEAF01: op>
    
```

The following example displays counter information for the specified counter.

```

supervisor@rtbrick>LEAF01: op> show qos policer counter lag-1
Interface      Level  Units      Total      Received      Dropped
lag-1          1     Packets    15773      15773         0
               Bytes    2555226    2555226     0
lag-1          2     Packets    15778      15778         0
    
```

lag-1	3	Bytes	2556036	2556036	0
		Packets	15775	15775	0
lag-1	4	Bytes	2555550	2555550	0
		Packets	23661	23661	0
lag-1-egress	1	Bytes	3423166	3423166	0
		Packets	7889	7889	0
lag-1-egress	2	Bytes	1420020	1420020	0
		Packets	7889	7889	0
lag-1-egress	3	Bytes	1420020	1420020	0
		Packets	7889	7889	0
lag-1-egress	4	Bytes	1420020	1420020	0
		Packets	49177	49177	0
		Bytes	8288974	8288974	0

## show qos profile

### Syntax:

**show qos profile** <option>

Option	Description
-	Without any option, this command displays a summary of all the QoS profiles.
<profile-name>	Displays QoS profile information.

The following example displays a summary of all the QoS profiles.

```

supervisor@rtbrick>LEAF01: op> show qos profile lac_4queues_4classes
Profile: lac_4queues_4classes
Classifier: residential-pbit-classifier
Policer: policer-residential
Scheduler map: lac_4queues_M
Class queue map: lac_4queues_M
Remark map: -
Class policer map: policer-map-l2tp
Mulifield classifier: -
supervisor@rtbrick>LEAF01: op>
    
```

## show qos queue

### Syntax:

**show qos queue** <option>

Option	Description
-	Without any option, this command displays a summary of all the queues.

Option	Description
class-to-queue-map	Displays queue class-to-queue-map information.
counter	Displays QoS queue counter information.
counter <interface-name>	Displays QoS queue counter information for the specified interface.
<interface-name>	Displays QoS queue details for the specified interface.

The following example displays a summary of all the queues.

```

supervisor@rtbrick>LEAF01: op> show qos queue
Applied queues:
  Interface           Queue           Queue Size      Min Thres      Max Thres      Drop Prob
Shaper
  ifl-0/0/10/100     BE_S            240000          -              -              -
-
  ifl-0/0/10/100     LD_S            200000          -              -              -
shaper_LD
  ifl-0/0/10/100     LL_S            200000          -              -              -
shaper_LL
  ifl-0/0/10/100     VO_S            50000           -              -              -
shaper_VO
  ifl-0/0/10/200     BE_S            240000          -              -              -
-
  ifl-0/0/10/200     LD_S            200000          -              -              -
shaper_LD
  ifl-0/0/10/200     LL_S            200000          -              -              -
shaper_LL
  ifl-0/0/10/200     VO_S            50000           -              -              -
shaper_VO
  ifl-0/0/10/300     BE_S            240000          -              -              -
-
  ifl-0/0/10/300     LD_S            200000          -              -              -
shaper_LD
  ifl-0/0/10/300     LL_S            200000          -              -              -
shaper_LL
  ifl-0/0/10/300     VO_S            50000           -              -              -
shaper_VO
Configured queues:
  Queue              Queue Size      Min Thres      Max Thres      Drop Prob
Shaper
  BE_L                375000          -              -              -
  BE_M                375000          -              -              -
  BE_S                240000          -              -              -
  CO_L                312500          -              -              -
  CO_M                156250          -              -              -
  CO_S                50000           -              -              -
  IO_L                312500          -              -              -
shaper_IO
  IO_M                156250          -              -              -
shaper_IO
  IO_S                50000           -              -              -
shaper_IO
  LD_L                1250000         -              -              -
shaper_LD
  LD_M                625000          -              -              -
shaper_LD
  LD_S                200000          -              -              -
shaper_LD
  LL_L                1250000         -              -              -
shaper_LL
  LL_M                625000          -              -              -
shaper_LL
  LL_S                200000          -              -              -
shaper_LL
  VO_L                312500          -              -              -
    
```

```

shaper_VO
  VO_M          156250      -          -          -
shaper_VO
  VO_S          50000      -          -          -
shaper_VO
  free_6_L     375000      -          -          -          -
  free_6_M     375000      -          -          -          -
  free_6_S     240000      -          -          -          -
  free_7_L     375000      -          -          -          -
  free_7_M     375000      -          -          -          -
  free_7_S     240000      -          -          -          -
    
```

The following example displays queue information for the specified interface.

```

supervisor@rtbrick>LEAF01: op> show qos queue if1-0/0/10/100
Applied queues:
  Interface      Queue           Queue Size    Min Thres    Max Thres    Drop Prob
Shaper
if1-0/0/10/100  BE_S           240000       -            -            -
-
if1-0/0/10/100  LD_S           200000       -            -            -
shaper_LD
if1-0/0/10/100  LL_S           200000       -            -            -
shaper_LL
if1-0/0/10/100  VO_S           50000        -            -            -
shaper_VO
    
```

The following example displays queue counter information.

```

supervisor@rtbrick>LEAF01: op> show qos queue counter
Interface      Queue Group      Queue           Class  Units  Received
Queued        Dropped
0              0
if1-0/1/32/6  olt-dpu-mgmt-queues  OLT_MGMT      0      Bytes  0
0              0
0              0
if1-0/1/33/4  olt-dpu-mgmt-queues  OLT_MGMT      0      Bytes  0
0              0
0              0
if1-0/1/33/6  olt-dpu-mgmt-queues  OLT_MGMT      0      Bytes  0
0              0
0              0
ppp-0/1/30/72339069014638594  pta-4queues      BE_PTA        0      Bytes  941111
288270        652841
288837428    653986284
ppp-0/1/30/72339069014638594  pta-4queues      LD_PTA        2      Bytes  942823712
446474        492385
448259896    494354540
ppp-0/1/30/72339069014638594  pta-4queues      LL_PTA        1      Bytes  938859
480506        458345
482428024    460178380
ppp-0/1/30/72339069014638594  pta-4queues      VO_PTA        3      Bytes  942614436
673116        2994141
175010160    778476660
12bsa-0/1/30/281479271677953  12bsa-4queues    BE_L2BSA     0      Bytes  3667257
0              0
0              0
12bsa-0/1/30/281479271677953  12bsa-4queues    LD_L2BSA     2      Bytes  953486820
0              0
    
```

```

0                               0                               Bytes      0
12bsa-0/1/30/281479271677953  12bsa-4queues           LL_L2BSA    1           Packets    0
0                               0                               Bytes      0
0                               0                               Bytes      0
    
```

The following example displays queue counter information for the specified interface.

```

supervisor@rtbrick>LEAF01: op> show qos queue counter ifl-0/1/30/6
Interface           Queue Group           Queue                Class  Units      Received
Queued             Dropped
ifl-0/1/30/6       olt-dpu-mgmt-queues  OLT_MGMT            0      Packets    0
0                  0
0                  0
0                  0
                                Bytes      0
    
```

## show qos scheduler

### Syntax:

**show qos scheduler** <option>

Option	Description
-	Without any option, this command displays a summary of all the schedulers.
<scheduler-name>	Displays scheduler information for the specified scheduler.

The following example displays a summary of all the schedulers.

```

supervisor@rtbrick>LEAF01: op> show qos scheduler
Scheduler           Type                Shaper                Composite  Active
fff                 strict_priority     -                     False     False
ffff                strict_priority     -                     False     False
lac_4queues         strict_priority     -                     True      False
olt-pon1            fair_queueing       -                     False     False
olt-pon10           fair_queueing       -                     False     False
olt-pon11           fair_queueing       -                     False     False
olt-pon12           fair_queueing       -                     False     False
olt-pon13           fair_queueing       -                     False     False
olt-pon14           fair_queueing       -                     False     False
olt-pon15           fair_queueing       -                     False     False
olt-pon16           fair_queueing       -                     False     False
olt-pon17           fair_queueing       -                     False     False
olt-pon18           fair_queueing       -                     False     False
olt-pon19           fair_queueing       -                     False     False
olt-pon2            fair_queueing       -                     False     False
olt-pon20           fair_queueing       -                     False     False
olt-pon21           fair_queueing       -                     False     False
olt-pon22           fair_queueing       -                     False     False
olt-pon23           fair_queueing       -                     False     False
olt-pon24           fair_queueing       -                     False     False
    
```

```

olt-pon25      fair_queueing - False False
olt-pon26      fair_queueing - False False
olt-pon27      fair_queueing - False False
olt-pon28      fair_queueing - False False
olt-pon29      fair_queueing - False False
olt-pon3       fair_queueing - False False
olt-pon30      fair_queueing - False False
olt-pon31      fair_queueing - False False
olt-pon32      fair_queueing - False False
olt-pon4       fair_queueing - False False
olt-pon5       fair_queueing - False False
olt-pon6       fair_queueing - False False
olt-pon7       fair_queueing - False False
olt-pon8       fair_queueing - False False
olt-pon9       fair_queueing - False False
pta_4queues_comp_off  strict_priority - True False
pta_4queues_comp_on   strict_priority - True False
pta_8queues_comp_off  strict_priority - True False
pta_8queues_comp_on   strict_priority - True False
supervisor@rtbrick>LEAF01: op>

```

The following example displays scheduler information for the specified scheduler.

```

supervisor@rtbrick>LEAF01: op> show qos scheduler lac_4queues
Scheduler      Type           Shaper      Composite    Active
lac_4queues    strict_priority -            True         False

```

### show qos scheduler-map

#### Syntax:

**show qos scheduler-map** <option>

Option	Description
-	Without any option, this command displays a summary of all the scheduler maps.
<scheduler-map>	Displays scheduler information for the specified scheduler map.

The following example displays a summary of all the scheduler maps.

```

supervisor@rtbrick>LEAF01: op> show qos scheduler-map
Scheduler-Map: lac_4queues_S
  Scheduler: fff           Scheduler: strict_priority
  Queue: LD_S             strict_priority_1
  Scheduler: pta_4queues_comp_off Scheduler: strict_priority
  Queue: LL_S             strict_priority_1
  Queue: VO_S             strict_priority_0
  Scheduler: fffd         Scheduler: strict_priority
  Queue: BE_S             strict_priority_0
Scheduler-Map: schedmap-olt
  Scheduler: olt-pon1     Scheduler: fair_queueing

```

```
Scheduler: olt-pon2 Scheduler: fair_queueing
Scheduler: olt-pon3 Scheduler: fair_queueing
Scheduler: olt-pon4 Scheduler: fair_queueing
Scheduler: olt-pon5 Scheduler: fair_queueing
Scheduler: olt-pon6 Scheduler: fair_queueing
Scheduler: olt-pon7 Scheduler: fair_queueing
Scheduler: olt-pon8 Scheduler: fair_queueing
Scheduler: olt-pon9 Scheduler: fair_queueing
Scheduler: olt-pon10 Scheduler: fair_queueing
Scheduler: olt-pon11 Scheduler: fair_queueing
Scheduler: olt-pon12 Scheduler: fair_queueing
Scheduler: olt-pon13 Scheduler: fair_queueing
Scheduler: olt-pon14 Scheduler: fair_queueing
Scheduler: olt-pon15 Scheduler: fair_queueing
Scheduler: olt-pon16 Scheduler: fair_queueing
Scheduler: olt-pon17 Scheduler: fair_queueing
Scheduler: olt-pon18 Scheduler: fair_queueing
Scheduler: olt-pon19 Scheduler: fair_queueing
Scheduler: olt-pon20 Scheduler: fair_queueing
Scheduler: olt-pon21 Scheduler: fair_queueing
Scheduler: olt-pon22 Scheduler: fair_queueing
Scheduler: olt-pon23 Scheduler: fair_queueing
Scheduler: olt-pon24 Scheduler: fair_queueing
Scheduler: olt-pon25 Scheduler: fair_queueing
Scheduler: olt-pon26 Scheduler: fair_queueing
Scheduler: olt-pon27 Scheduler: fair_queueing
Scheduler: olt-pon28 Scheduler: fair_queueing
Scheduler: olt-pon29 Scheduler: fair_queueing
Scheduler: olt-pon30 Scheduler: fair_queueing
Scheduler: olt-pon31 Scheduler: fair_queueing
Scheduler: olt-pon32 Scheduler: fair_queueing
Scheduler: olt-pon33 Scheduler: False
Scheduler-Map: lac_4queues_L
Scheduler: lac_4queues Scheduler: strict_priority
Queue: BE_L strict_priority_1
Queue: LD_L strict_priority_1
Queue: LL_L strict_priority_2
Queue: VO_L strict_priority_0
```

The following example displays scheduler information for the specified scheduler-map.

```
supervisor@rtbrick>LEAF01: op> show qos scheduler-map lac_4queues_S
Scheduler-Map: lac_4queues_S
Scheduler: fff Scheduler: strict_priority
Queue: LD_S strict_priority_1
Scheduler: pta_4queues_comp_off Scheduler: strict_priority
Queue: LL_S strict_priority_1
Queue: VO_S strict_priority_0
Scheduler: fffd Scheduler: strict_priority
Queue: BE_S strict_priority_0
```

## show qos shaper

### Syntax:

## show qos shaper <option>

Option	Description
-	Without any option, this command displays a summary of all the shapers.
<shaper-name>	Displays scheduler information for the specified shaper.

The following example displays a summary of all the shapers.

```

supervisor@rtbrick>LEAF01: op> show qos shaper
Shaper          High Rate(Kbps)  Low Rate(Kbps)  High Burst(Kb)  Low Burst(Kb)  Active
pon-shaper      2488000          -               -               -               True
shaper_IO       -                1000000        -               -               True
shaper_LD       1000000         -               -               -               True
shaper_LL       1000000         -               -               -               True
shaper_VO       1000000         -               -               -               True
shaper_session  1000000         100            -               -               True
    
```

The following example displays shaper information for the specified shaper.

```

supervisor@rtbrick>LEAF01: op> show qos shaper shaper_session
Shaper          High Rate(Kbps)  Low Rate(Kbps)  High Burst(Kb)  Low Burst(Kb)  Active
shaper_session  1000000         100            -               -               False
    
```

## show qos multifield-classifier

### Syntax:

## show qos multifield-classifier <option>

Option	Description
-	Without any option, this command displays a summary of all the multifield classifiers.
<multifield-classifier-name>	Displays scheduler information for the specified multifield classifiers.

The following example displays a summary of all the multifield classifiers.

```

supervisor@rtbrick>LEAF01: op> show qos multifield-classifier
Multifield Classifier: global-mfc
  ACL type: multifield_ipv4
  Ordinal: 10000
  Match:
    
```



```
    Source IPv4 prefix: 198.51.100.2/24
    IPv4 TOS: 224
  Action:
    Forward class: class-7
Priority: 1000
Ordinal: 9000
  Match:
    Source IPv4 prefix: 198.51.100.2/24
    IPv4 TOS: 192
  Action:
    Remark codepoint: 184
    Forward class: class-6
Ordinal: 6200
  Match:
    Source IPv4 prefix: 198.51.100.2/24
    IPv4 TOS: 160
  Action:
    Remark codepoint: 184
    Forward class: class-5
Ordinal: 5200
  Match:
    Source IPv4 prefix: 198.51.100.2/24
    IPv4 TOS: 64
  Action:
    Remark codepoint: 184
    Forward class: class-2
Ordinal: 6000
  Match:
    Source IPv4 prefix: 198.51.100.2/24
    IPv4 TOS: 96
  Action:
    Remark codepoint: 184
    Forward class: class-3
Ordinal: 5000
  Match:
    Source IPv4 prefix: 198.51.100.2/24
  Action:
    Remark codepoint: 184
    Forward class: class-0
Ordinal: 6100
  Match:
    Source IPv4 prefix: 198.51.100.2/24
    IPv4 TOS: 128
  Action:
    Remark codepoint: 184
    Forward class: class-4
Ordinal: 5100
  Match:
    Source IPv4 prefix: 198.51.100.2/24
    IPv4 TOS: 32
  Action:
    Remark codepoint: 184
    Forward class: class-1
Ordinal: 100
  Match:
    Source IPv6 prefix: 2001:db8:0:100::/32
    IPv6 TC: 224
  Action:
    Remark codepoint: 196
    Forward class: class-3
Multifield Classifier: ipoe-double-play
```

```
ACL type: multifield_ipv4
Ordinal: 5200
Match:
  Destination IPv4 prefix: 198.51.100.2/24
  IPv4 TOS: 160
Action:
  Remark codepoint: 224
  Forward class: class-2
Ordinal: 5000
Match:
  Destination IPv4 prefix: 198.51.100.2/24
  IPv4 TOS: 64
Action:
  Remark codepoint: 224
  Forward class: class-0
Ordinal: 5300
Match:
  Destination IPv4 prefix: 198.51.100.2/24
  IPv4 TOS: 192
Action:
  Remark codepoint: 224
  Forward class: class-3
Ordinal: 5100
Match:
  Destination IPv4 prefix: 198.51.100.2/24
  IPv4 TOS: 96
Action:
  Remark codepoint: 224
  Forward class: class-1
supervisor@rtbrick>LEAF01: op>
```

The following example displays multifield-classifier information for the specified multifield-classifier.

```
supervisor@rtbrick>LEAF01: op> show qos multifield-classifier global-mfc
Multifield Classifier: global-mfc
ACL type: multifield_ipv4
Ordinal: 10000
Match:
  Source IPv4 prefix: 198.51.100.2/24
  IPv4 TOS: 224
Action:
  Forward class: class-7
Priority: 1000
Ordinal: 9000
Match:
  Source IPv4 prefix: 198.51.100.2/24
  IPv4 TOS: 192
Action:
  Remark codepoint: 184
  Forward class: class-6
Ordinal: 6200
Match:
  Source IPv4 prefix: 198.51.100.2/24
  IPv4 TOS: 160
Action:
  Remark codepoint: 184
  Forward class: class-5
```

```

Ordinal: 5200
Match:
  Source IPv4 prefix: 198.51.100.2/24
  IPv4 TOS: 64
Action:
  Remark codepoint: 184
  Forward class: class-2
supervisor@rtbrick>LEAF01: op>

```

## Displaying QoS Statistics for Layer-2 and Layer-3 Logical Interfaces

To display QoS Statistics for layer-2 and layer-3 logical interfaces, enter the following command:

**show interface** <layer-2/layer-3 interface> **statistics**

To obtain detailed view of QoS statistics for layer-2 and layer-3 logical interfaces, enter the following command:

**show interface** <layer-2/layer-3 interface> **detail**

To clear QoS statistics of layer-2 and layer-3 logical interfaces, enter the following command:

**clear interface statistics** <layer-2/layer-3 interface>

The following example displays QoS Statistics for the interface **ifl-0/1/46/501**.

```

supervisor@rtbrick>LEAF01: op> show interface ifl-0/1/46/501 statistics
Logical Interface:  ifl-0/1/46/501
VPP statistics:
  Counter          Unit      Count
Packet statistics:
  Ingress forwarded packets: 67598           Ingress forwarded bytes: 69872136
  Ingress drop Packets: 12378422           Ingress drop bytes: 12799221528
  Egress forwarded packets: 67370           Egress forwarded bytes: 69369760
  Egress drop packets: 0                   Egress drop bytes: 0
  Egress Class (Queue) Statistics:
    class-0: 67370 packets 69369760 bytes dropped: 0 packets 0 bytes
    class-1: 0 packets 0 bytes dropped: 0 packets 0 bytes
    class-2: 0 packets 0 bytes dropped: 0 packets 0 bytes
    class-3: 0 packets 0 bytes dropped: 0 packets 0 bytes
    class-4: 0 packets 0 bytes dropped: 0 packets 0 bytes
    class-5: 0 packets 0 bytes dropped: 0 packets 0 bytes
    class-6: 0 packets 0 bytes dropped: 0 packets 0 bytes
    class-7: 0 packets 0 bytes dropped: 0 packets 0 bytes
  Ingress Policer Statistics:
    Level 1: 0 packets 0 bytes dropped: 0 packets 0 bytes
    Level 2: 0 packets 0 bytes dropped: 0 packets 0 bytes
    Level 3: 0 packets 0 bytes dropped: 0 packets 0 bytes
    Level 4: 67598 packets 69872136 bytes dropped: 12378422 packets 12799221528 bytes
supervisor@rtbrick>ufi07.q2c.u21.r4.nbg.rtbrick.net: op>

```

The following example displays detailed QoS Statistics for the interface `ifl-0/1/46/501`.

```
supervisor@rtbrick>LEAF01: op> show interface ifl-0/1/46/501 detail
Logical Interface:  ifl-0/1/46/501
VPP statistics:
  Counter          Unit      Count
Packet statistics:
  Ingress forwarded packets: 67598          Ingress forwarded bytes: 69872136
  Ingress drop Packets: 12378422          Ingress drop bytes: 12799221528
  Egress forwarded packets: 67370          Egress forwarded bytes: 69369760
  Egress drop packets: 0                  Egress drop bytes: 0
  Egress Class (Queue) Statistics:
    class-0: 67370 packets 69369760 bytes dropped: 0 packets 0 bytes
    class-1: 0 packets 0 bytes dropped: 0 packets 0 bytes
    class-2: 0 packets 0 bytes dropped: 0 packets 0 bytes
    class-3: 0 packets 0 bytes dropped: 0 packets 0 bytes
    class-4: 0 packets 0 bytes dropped: 0 packets 0 bytes
    class-5: 0 packets 0 bytes dropped: 0 packets 0 bytes
    class-6: 0 packets 0 bytes dropped: 0 packets 0 bytes
    class-7: 0 packets 0 bytes dropped: 0 packets 0 bytes
  Ingress Policer Statistics:
    Level 1: 0 packets 0 bytes dropped: 0 packets 0 bytes
    Level 2: 0 packets 0 bytes dropped: 0 packets 0 bytes
    Level 3: 0 packets 0 bytes dropped: 0 packets 0 bytes
    Level 4: 67598 packets 69872136 bytes dropped: 12378422 packets 12799221528 bytes
```

## 13.9. LLDP

### 13.9.1. LLDP Overview

Link Layer Discovery Protocol (LLDP) is a media-independent link layer protocol used by network devices for advertising their identity, capabilities to neighbors on a LAN segment. LLDP runs over the data-link layer only, allowing two systems running different network layer protocols to learn about each other.

LLDP supports a set of attributes that it uses to discover neighbor devices. These attributes contain type, length, and value descriptions and are referred to as TLVs. LLDP supported devices can use TLVs to receive and send information to their neighbors. Details such as configuration information, device capabilities, and device identity can be advertised using this protocol.

### Guidelines

- All LLDP packets are sent to the CPU for further processing.
- LLDP packets will be lower priority packets when compared with the routing protocol packets. In case of a congestion, the LLDP packets may be policed.

## Limitations

- LLDP currently does not intend to work on bundle interfaces.
- LLDP is disabled for the following interfaces on L2BSA L2X:

Physical interfaces on Q2C platform

LAG member interfaces on QAX platform

## Interactions with other features

RBFS provides various daemons that run as background processes. LLDP interacts with these daemons for accessing necessary configurations.

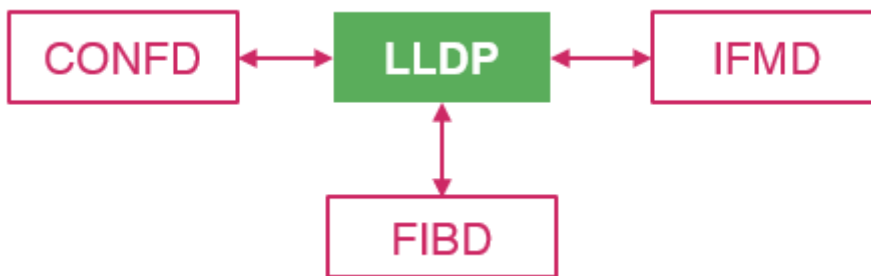

The table below shows the interactions of LLDP with the other daemons of RBFS.

Daemon Name	Daemon Description	Interaction Details
Confd	Configuration	<p><i>Confd</i> stores all the LLDP configuration information. LLDP subscribes for the following tables of <i>Confd</i>:</p> <ul style="list-style-type: none"> <li>• <code>global.lldp.config</code></li> <li>• <code>global.lldp.interface.config</code></li> </ul>
IFMD	Interface Monitoring	<p>LLDP is enabled on the physical interface. LLDP subscribes to the IFP table to find the status of the physical link. An LLDP message can be sent only to those interfaces whose link state is UP.</p>

<b>Daemon Name</b>	<b>Daemon Description</b>	<b>Interaction Details</b>
FIBD	Forwarding Information Base	<i>FIBD</i> subscribes for the LLDP interface table which has all the information required for enabling LLDP on the interface. This is used to program in VPP. Any neighbor detected, VPP will notify and this detection is stored in the FIBD table for tracking purpose. Each time a message is received from the neighbor, it will be updated in this table. Thus, the history of the messages received from the neighbor is tracked. This information is stored in one of the FIBD tables. LLDP subscribes to this table to find its neighbor.

### **LLDP Limitations with L2X**

LLDP is disabled in the following scenario:

1. The outgoing-interface is configured in the egress L2X.
2. The outgoing-interface is configured in the ingress L2X with the match-type as "any" or "untagged".
3. The outgoing-interface and incoming-interface are configured in the bi-directional L2X.

### **Supported Platforms**

Not all features are necessarily supported on each hardware platform. Refer to the *Platform Guide* for the features and the sub-features that are or are not supported by each platform.

## **13.9.2. LLDP Configuration**

### **Configuration Hierarchy**

The diagram illustrates the LLDP configuration hierarchy.

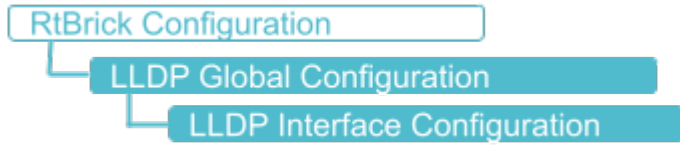

## Configuration Syntax and Commands

The following sections describe the LLDP configuration syntax and commands.

### LLDP Global Configuration

#### Syntax:

**set lldp** <attribute> <value>

Attribute	Description
admin-status [disable   enable]	Enable or disable LLDP. LLDP is enabled, by default.
system-description <system description>	LLDP global system description to be sent to the neighbor
system-name <system name>	LLDP global system name to be sent to the neighbor. If the system name is not configured, it is fetched from BDS.
tx-hold <transmit hold time>	Specifies the amount of time (in seconds) a receiving device maintains the neighbor information before aging your device. If the timer expires and no LLDP packet was received, the neighbor will be marked as DOWN. Default value is 120 seconds. The hold-time range is 1 through 360000.
tx-interval <advertisement interval>	Interval (in seconds) at which LLDP packets are sent to neighbors. Default interval value is 30 seconds. The transmission interval range is 1 through 3600 seconds.

#### Example 1: Enable LLDP

```

{
  "rtbrick-config:lldp": {
    "admin-status": "enable",
  }
}
  
```

```

    "system-name": "rtbrick",
    "system-description": "This is rtbrick system",
    "tx-interval": 40,
    "tx-hold": 150
  }
}

```

## LLDP Interface Configuration

### Syntax:

**set lldp interface** <interface-name> <attribute> <value>

Attribute	Description
interface <interface name>	Name of the interface on which you enable or disable LLDP. By default, the interface is enabled. NOTE: Interface level configuration will override the global LLDP enable/disable functionality.
admin-status [disable or enable]	LLDP is enabled by default. The command <i>set lldp admin-status disable</i> is used to disable it. If you want to re-enable it, run the <i>set lldp admin-status enable</i> command.
port-desc <port description>	LLDP port description to be sent to the neighbor. If the port description is not configured, the description configured under interface from IFMD is taken as LLDP port description.

### Example 1: LLDP on Interface Configuration

```

{
  "rtbrick-config:lldp": {
    "interface": [
      {
        "interface-name": "ifp-0/0/1",
        "port-description": "this is port ifp-0/0/1",
        "admin-status": "enable"
      }
    ]
  }
}

```



## 13.9.3. LLDP Operational Commands

### LLDP Show Commands

The LLDP show commands provide detailed information about the LLDP global summary, neighbors, and interfaces.

#### Syntax:

**show lldp** <option>

Option	Description
interface	Displays information about interfaces where LLDP is enabled.
neighbor	Displays information about all the neighbors.
summary	Displays global summary details such as system name, frequency of transmissions, the hold-time for the packets sent, TLVs, and the disabled TLVs.

### LLDP Interfaces

The command displays the information about interfaces where LLDP is enabled.

#### Syntax:

**show lldp interface** <attribute> <value>

Option	Description
interface-name	Displays summary details such as status, MAC address and description.

#### Example 1: LLDP interface summary

```

root@rtbrick: op> show lldp interface
Interface name      Status  MAC address      Description
ifp-0/0/0          Down   7a:77:6a:01:00:01  Physical interface #0 from
node 0, chip 0
ifp-0/0/1          Up     7a:77:6a:01:00:02  Physical interface #1
from node 0, chip 0
ifp-0/0/2          Up     7a:77:6a:01:00:05  Physical interface #2
from node 0, chip 0

```

Example 2: For the interfaces where L2X is configured, LLDP is suppressed as shown in the following example.

```

root@rtbrick: op> show lldp interface
Interface name Status MAC address Description
ifp-0/0/0 Suppress 7a:3a:ce:60:00:00 Suppressed by L2X : L2X1
ifp-0/0/1 Suppress 7a:3a:ce:60:00:01 Suppressed by L2X : L2X2
    
```

## LLDP Neighbors

This command displays the information of all neighbors.

### Syntax:

**show lldp neighbor** <attribute> <value>

Option	Description
detail	Displays the information in detail about a specific LLDP neighbor or all neighbors.
interface-name	Name of the interface on which neighbor is formed.

### Example 1: LLDP neighbor summary

```

root@rtbrick: op> show lldp neighbor
Neighbor name      Status Remote port ID      Local port ID      Neighbor MAC
address Last received      Last sent
fwdd-r2           Up      ifp-0/0/1             ifp-0/0/1
7a:1a:c9:00:00:01 0:00:05 ago          0:00:05 ago
fwdd-r2           Up      ifp-0/0/2             ifp-0/0/2
7a:1a:c9:00:00:04 0:00:05 ago          0:00:05 ago
    
```

### Example 2: LLDP all neighbor details

```

root@rtbrick: op> show lldp neighbor detail

Neighbor: fwdd-r2
Neighbor MAC address: 7a:1a:c9:00:00:01
Neighbor port ID: ifp-0/0/1
Neighbor port description: Physical interface #1 from node 0, chip 0
Neighbor TTL: 121
Neighbor timeout: 121000
Local interface: ifp-0/0/1
Local MAC address: 7a:77:6a:01:00:02
Local port description: Physical interface #1 from node 0, chip 0
Packets sent: 35
Packets received: 36
Neighbor status: Up
    
```

```
Neighbor: fwdd-r2
Neighbor MAC address: 7a:1a:c9:00:00:04
Neighbor port ID: ifp-0/0/2
Neighbor port description: Physical interface #2 from node 0, chip 0
Neighbor TTL: 121
Neighbor timeout: 121000
Local interface: ifp-0/0/2
Local MAC address: 7a:77:6a:01:00:05
Local port description: Physical interface #2 from node 0, chip 0
Packets sent: 35
Packets received: 36
Neighbor status: Up
```

### Example 3: LLDP specific neighbor details

```
root@rtbrick: op> show lldp neighbor ifp-0/0/1
Neighbor: fwdd-r2
Neighbor MAC address: 7a:1a:c9:00:00:01
Neighbor port ID: ifp-0/0/1
Neighbor port description: Physical interface #1 from node 0, chip 0
Neighbor TTL: 121
Neighbor timeout: 121000
Local interface: ifp-0/0/1
Local MAC address: 7a:77:6a:01:00:02
Local port description: Physical interface #1 from node 0, chip 0
Packets sent: 148
Packets received: 149
Neighbor status: Up
```

## LLDP Summary

The command displays the LLDP global summary information.

### Syntax:

#### show lldp summary

Option	Description
-	Without any options, the command displays LLDP global summary details such as status, MAC address and description.

### Example 1: LLDP System Summary

```
root@rtbrick: op> show lldp summary
Mode: global
System hostname: fwdd-r1
Transmit interval: 30 sec
```

```
Transmit holdtime: 120 sec
```

## LLDP Clear Commands

Clear commands allow to reset operational states.

### LLDP Neighbor

This commands resets LLDP neighbor.

#### Syntax:

**clear lldp neighbor** <option>

Option	Description
all	Clears all the LLDP neighbors.
<ifp-0/0/1>	Clears a specific neighbor on an interface.

Example: The example below shows how to clear all the LLDP neighbors.

```
supervisor@rtbrick: op> clear lldp neighbor all
```

# 14. Multicast

## 14.1. IGMP

### 14.1.1. IGMP Overview

Internet Group Management (IGMP) protocol allows a host to advertise its multicast group membership to neighboring switches and routers. IGMP is a standard protocol used by the TCP/IP protocol suite to achieve dynamic multicasting.

There are two components in the IGMP solution:

- IGMPv2/v3 Client: It sends Join or Leave messages to a multicast group. Typical example of a client is a SET-TOP box. The IGMP client can respond to any IGMP general queries or group-specific queries that are received.
- Multicast Router: The recipient of IGMP Join/Leave message. After receiving the message, it determines whether the corresponding message needs to be processed or not. After processing the IGMP messages, it sends this information to its multicast upstream router. Along with this, it can program certain entries in its routers which results in forwarding specific multicast packets on that interface.

### IGMPv3 Lite

IGMP version 3 adds support for "source filtering", that is, the ability for a system to report interest in receiving packets **only** from specific source addresses, or from **all but** specific source addresses, sent to a particular multicast address. That information may be used by multicast routing protocols to avoid delivering multicast packets from specific sources to networks where there are no interested receivers.

The RtBrick IGMP v3lite solution adds support for source filtering. Source filtering enables a multicast receiver host to signal from which groups it wants to receive multicast traffic, and from which sources this traffic is expected. That information may be used by multicast routing protocols to avoid delivering multicast packets from specific sources to networks where there are no interested receivers.

IGMP Version 3 will help conserve bandwidth by allowing a host to select the

specific sources from which it wants to receive traffic. Also, multicast routing protocols will be able to make use of this information to conserve bandwidth when constructing the branches of their multicast delivery trees.

## Static Joins

After an interface on a multicast device is configured to statically join an IGMP group, the multicast device considers that the interface has static multicast group members and sends multicast packets to this interface, regardless of whether hosts connected to this interface request the multicast packets.

## SSM Mapping

SSM mapping takes IGMPv2 reports and converts them to IGMPv3. In case of legacy devices, there could be a possibility that BNG might receive IGMPv2 membership reports. If BNG receives an IGMPv2 membership for a specific group G1, BNG uses the SSM mapping configuration to determine one or more Source (S) addresses for a given group. This SSM mappings are translated to the IGMPv3 joins like IGMPV3 JOIN INCLUDE (G, [S1, G1], [S2, G1] and so on) and BNG continues to process as if it has received from the subscriber.

## Supported Platforms

Not all features are necessarily supported on each hardware platform. Refer to the *Platform Guide* for the features and the sub-features that are or are not supported by each platform.

### 14.1.2. IGMP Configuration

#### Configuration Hierarchy

The diagram illustrates the IGMP configuration hierarchy.

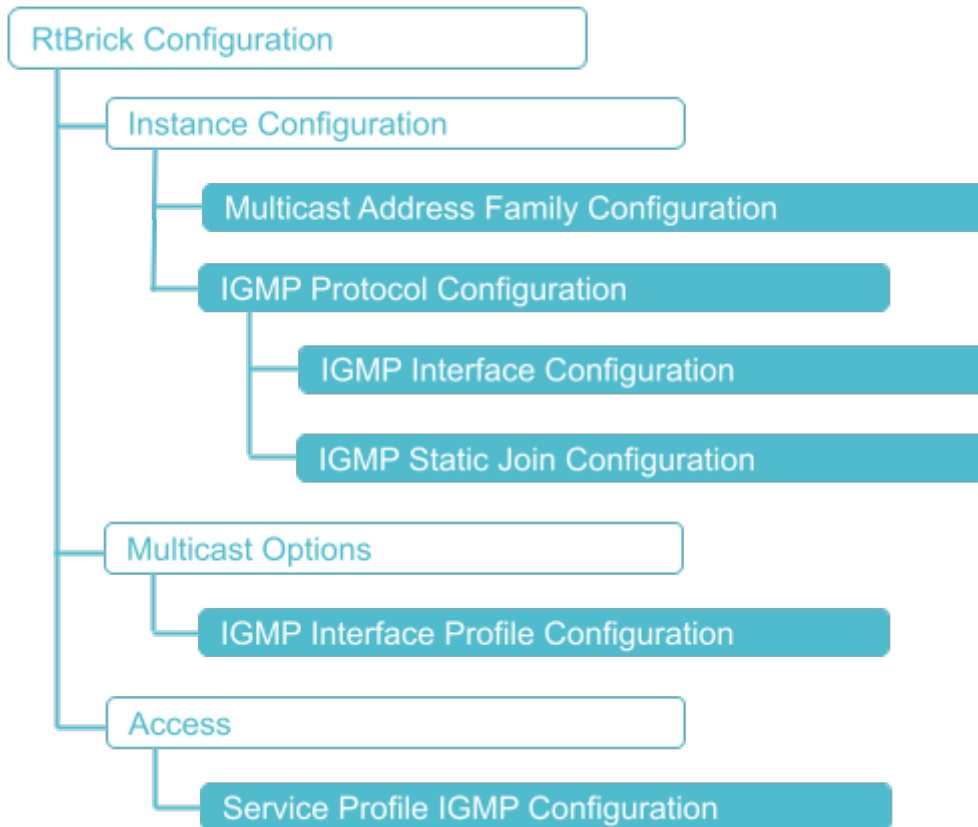

## Configuration Syntax and Commands

The following sections describe the interface configuration syntax and commands.

### Multicast Address Family Configuration

You can enable the multicast IPv4 address family under the IGMP instance using the following command:

#### Syntax:

**set instance** <instance> **address-family** <attribute> <value>

Attribute	Description
<instance>	Specifies the name of the network instance
<afi>	Address family identifier (AFI). Supported value: ipv4
<safi>	Subsequent address family identifier (SAFI), that is, multicast.

Example: Multicast Address Family Configuration

```
{
  "rtbrick-config:address-family": [
    {
      "afi": "ipv4",
      "safi": "multicast"
    }
  ]
}
```

## IGMP Protocol Configuration

To configure an IGMP on an instance, the same instance should be enabled globally with AFI IPv4 and SAFI as both unicast and multicast.

### Syntax:

**set instance** <instance> **protocol igmp** <attribute> <values>



If no instance is specified, IGMP will be enabled on the default instance.

Options	Description
<instance>	Name of the IGMP instance.
interfaces <...>	IGMP interface configuration. Refer to section 2.2.1.1 for the IGMP interface configuration.
robustness-variable <variable-value>	The robustness value is used by IGMP to determine the number of times to send messages. Default value: 3. Range: 0-255.
source-address <source-address>	Source address of the IGMP query at the instance-level. NOTE: IF subscriber IFL is configured with the source address, then takes priority; otherwise, the the instance-level source address will be used. If source address is not configured, 0.0.0.0 will be the default address.
static-group <...>	Static multicast route configuration. Refer to section 2.2.2.2 for the IGMP static join configuration.

### Example: IGMP Configuration

```
{
```



```

"rtbrick-config:igmp": {
  "robustness-variable": 5,
  "source-address": "198.51.100.177"
}

```

## IGMP Interface Configuration



When you start IGMP on an interface, it operates with the default settings.

### Syntax:

**set instance** <instance> **protocol igmp interfaces interface** <interface-name> <attribute> <value>

Attribute	Description
<instance>	Name of the instance
<interface-name>	Name of the IP multicast interface
max-groups <count>	Specifies the maximum count of multicast group memberships
version <version>	Specifies the IGMP version, that is, IGMPv2 or IGMPv3
interface-profile <profile>	Name of the interface configuration profile

### Example: IGMP Interface Configuration

```

{
  "rtbrick-config:interface": [
    {
      "interface-name": "ifl-0/0/0/1",
      "version": "IGMPv3",
      "max-groups": 30,
      "interface-profile": "profile1"
    }
  ]
}

```

## IGMP Static Join Configuration

### Syntax:

**set instance** <instance> **protocol igmp static-group** <attribute> <value>

## Command Parameters

<instance>	Specifies the instance name
<group-address>	Specifies the multicast address
<outgoing-interface>	Name of the outbound interface. The <b>null0</b> is a discard or sink interface for IGMP static join configuration. If IGMP Static Join is configured with the Null0 outgoing interface, then it is mandatory to configure the null0 IGMP interface.

### Example: IGMP Static Join Configuration

```

{
  "rtbrick-config:static-group": [
    {
      "group-address": "198.51.100.200",
      "source-address": "198.51.100.1",
      "outgoing-interface": "null0"
    }
  ]
}

```

## IGMP Interface Profile Configuration

### Syntax:

**set multicast-options igmp interface-profile** <attribute> <value>

Attribute	Description
filter-policy <filter-policy>	Specifies the filter policy. The policy should be defined under policy statement.
immediate-leave <enable   disable>	Enable or disable the immediate leave option. The <b>immediate-leave</b> attribute removes group membership immediately upon receiving a group leave membership report. If enabled, IGMP perform an immediate leave upon receiving an IGMP group leave message. If the router is IGMP-enabled, it sends an IGMP last member query with a last member query response time. However, the router does not wait for the response time before it prunes off the group querier-timeout-interval IGMP other querier timeout. Default: 425s

Attribute	Description
query-interval <query-interval>	IGMP query interval in seconds. The query interval ranges from 1 to 1024 seconds. The default value is 125 seconds.
query-max-response-time <query-max-response-time>	Maximum query response interval in seconds. The maximum query response interval ranges from 1 to 1024 seconds. The default value is 100 seconds.
ssm-map-policy <ssm-map-policy>	IGMP SSM policy name. The policy for <b>(,G) mapping to (S,G)</b>
start-query-count <start-query-count>	Specifies the number of queries sent out on startup, separated by the Start Query Interval. The start query count ranges from 1 to 1024. The default value is 3.
start-query-interval <start-query-interval>	Specifies the start query interval. The start-query-interval ranges from 1 to 1024 seconds. The default value is 31 seconds (query-interval/4).

### Example: IGMP Interface Profile Configuration

```

{
  "rtbrick-config:interface-profile": [
    {
      "profile-name": "profile1",
      "immediate-leave": "enable",
      "query-interval": 30,
      "query-max-response-time": 10,
      "start-query-count": 10,
      "start-query-interval": 10,
      "filter-policy": "filter_policy",
      "ssm-map-policy": "ssm_policy"
    }
  ]
}
    
```

### Service Profile IGMP Configuration

#### Syntax:

**set access service-profile** <profile-name> **igmp** <attribute> <value>

Attribute	Description
<profile-name>	Name of the service profile

Attribute	Description
enable <true   false>	Enable IGMP service
max-members <max-members>	Maximum IGMP membership per subscriber
profile <profile>	IGMP profile
version [IGMPv1/IGMPv2/IGMPv3]	IGMP version. The default IGMP version is IGMPv3.

### Example: Service Profile IGMP Configuration

```
{
  "rtbrick-config:service-profile": [
    {
      "profile-name": "service-profile1",
      "igmp": {
        "enable": "true",
        "profile": "INTERFACE_PROFILE_1",
        "version": "IGMPv3",
        "max-members": 10
      }
    }
  ]
}
```

## IGMP Configuration Example

```
{
  "ietf-restconf:data": {
    "rtbrick-config:instance": [
      {
        "name": "default",
        "protocol": {
          "igmp": {
            "robustness-variable": 5,
            "source-address": "198.51.100.91"
          }
        }
      }
    ],
    "rtbrick-config:multicast-options": {
      "igmp": {
        "interface-profile": [
          {
            "profile-name": "INTERFACE_PROFILE_1",
            "query-interval": 10,
            "filter-policy": "FILTER_POLICY_1"
          },
          {
            "profile-name": "INTERFACE_PROFILE_2",
            "query-interval": 20,

```

```

        "ssm-map-policy": "SSM_POLICY_1"
      }
    ]
  },
  "rtbrick-config:policy": {
    "statement": [
      {
        "name": "FILTER_POLICY_1",
        "ordinal": [
          {
            "ordinal": 1,
            "match": {
              "rule": [
                {
                  "rule": 1,
                  "type": "ipv4-mcast-group",
                  "value-type": "discrete",
                  "match-type": "or-longer",
                  "value": "198.51.100.20/24"
                }
              ]
            },
            "action": {
              "rule": [
                {
                  "rule": 1,
                  "operation": "return-deny"
                }
              ]
            }
          },
          {
            "ordinal": 2,
            "action": {
              "rule": [
                {
                  "rule": 1,
                  "operation": "return-permit"
                }
              ]
            }
          }
        ]
      }
    ],
    {
      "name": "SSM_POLICY_1",
      "ordinal": [
        {
          "ordinal": 1,
          "match": {
            "rule": [
              {
                "rule": 1,
                "type": "ipv4-mcast-group",
                "value-type": "discrete",
                "match-type": "or-longer",
                "value": "198.51.100.10/24"
              }
            ]
          }
        }
      ]
    },
  },
}

```

```

        "action": {
          "rule": [
            {
              "rule": 1,
              "type": "ipv4-mcast-source",
              "operation": "overwrite",
              "value": "198.51.100.11/24"
            }
          ]
        }
      ]
    },
    "rtbrick-config:access": {
      "interface": {
        "double-tagged": [
          {
            "interface-name": "ifp-0/0/1",
            "outer-vlan-min": 1,
            "outer-vlan-max": 4049,
            "inner-vlan-min": 1,
            "inner-vlan-max": 4049,
            "access-type": "PPPoE",
            "access-profile-name": "access-profile1",
            "service-profile-name": "service-profile1",
            "aaa-profile-name": "aaa-profile1"
          }
        ]
      },
      "service-profile": [
        {
          "profile-name": "service-profile1",
          "igmp": {
            "enable": "true",
            "profile": "INTERFACE_PROFILE_1",
            "version": "IGMPv3",
            "max-members": 10
          }
        }
      ]
    }
  }
}

```

### 14.1.3. IGMP Operational Commands

#### IGMP Show Commands

##### Syntax:

**show igmp** <option>

Option	Description
group	IGMP group summary information
group <group>	IGMP group detailed information
group instance <name>	IGMP group summary information in a specific instance
group outgoing-interface <interface_name>	IGMP group detailed information over a specific interface
interface	IGMP logical-interface summary information
interface instance <name>	IGMP interface summary information on specific instance
interface <interface_name>	IGMP interface detailed information

Example 1: Display IGMP interface details for all instances

```

supervisor@rtbrick>LEAF01: op> show igmp interface
Interface          Primary Address  State           Querier Address
Instance          Uptime
null0              n/a              n/a             n/a
vpn1               n/a
ppp-0/0/3/72339069014638597  198.51.100.100  Querier        198.51.100.133
vpn1              03h:37m:31s
    
```

Example 2: Display the interface summary for a specific instance

```

supervisor@rtbrick>LEAF01: op> show igmp interface instance vpn1
Interface          Primary Address  State           Querier Address
Instance          Uptime
null0              n/a              n/a             n/a
vpn1               n/a
ppp-0/0/3/72339069014638597  198.51.100.100  Querier        198.51.100.133
vpn1              03h:37m:39s
    
```

Example 3: Display IGMP group summary on all instances

```

supervisor@rtbrick>LEAF01: op> show igmp group
Source Address      Group Address      Interface          Instance
Uptime             Expires            Version
198.51.100.79      198.51.100.233    null0              vpn1
03h:42m:33s       n/a                IGMP
198.51.100.43      198.51.100.222    null0              vpn1
03h:42m:33s       n/a                IGMP
198.51.100.51      198.51.100.71     ppp-0/0/3/72339069014638597  vpn1
00h:32m:58s       1m 43s            IGMPv3
    
```

198.51.100.51	198.51.100.72	ppp-0/0/3/72339069014638597	vpn1
00h:33m:03s	1m 48s	IGMPv3	
198.51.100.53	198.51.100.73	ppp-0/0/3/72339069014638597	vpn1
00h:35m:26s	3m 36s	IGMPv3	
198.51.100.54	198.51.100.74	ppp-0/0/3/72339069014638597	vpn1
00h:35m:26s	3m 35s	IGMPv3	
198.51.100.56	198.51.100.115	ppp-0/0/3/72339069014638597	vpn1
03h:38m:16s	3m 33s	IGMPv3	
198.51.100.57	198.51.100.117	ppp-0/0/3/72339069014638597	vpn1
03h:38m:16s	3m 29s	IGMPv3	
198.51.100.58	198.51.100.18	ppp-0/0/3/72339069014638597	vpn1
03h:38m:16s	3m 42s	IGMPv3	
198.51.100.59	198.51.100.19	ppp-0/0/3/72339069014638597	vpn1
03h:38m:16s	3m 35s	IGMPv3	
198.51.100.90	198.51.100.64	ppp-0/0/3/72339069014638597	vpn1
03h:38m:16s	3m 40s	IGMPv3	
198.51.100.225	198.51.100.68	ppp-0/0/3/72339069014638597	vpn1
00h:35m:26s	3m 40s	IGMPv3	

Example 4: Display the group summary on specific instance

```

supervisor@rtbrick>LEAF01: op> show igmp group instance vpn1
Source Address      Group Address      Interface          Instance
Uptime             Expires            Version
198.51.100.79      198.51.100.233    null0              vpn1
03h:42m:37s       n/a                IGMP
198.51.100.43      198.51.100.233    null0              vpn1
03h:42m:37s       n/a                IGMP
198.51.100.51      198.51.100.71     ppp-0/0/3/72339069014638597  vpn1
00h:33m:02s       1m 40s            IGMPv3
198.51.100.51      198.51.100.72     ppp-0/0/3/72339069014638597  vpn1
00h:33m:07s       1m 45s            IGMPv3
198.51.100.53      198.51.100.73     ppp-0/0/3/72339069014638597  vpn1
00h:35m:30s       3m 41s            IGMPv3
198.51.100.54      198.51.100.74     ppp-0/0/3/72339069014638597  vpn1
00h:35m:30s       3m 43s            IGMPv3
198.51.100.56      198.51.100.115    ppp-0/0/3/72339069014638597  vpn1
03h:38m:20s       3m 43s            IGMPv3
198.51.100.57      198.51.100.117    ppp-0/0/3/72339069014638597  vpn1
03h:38m:20s       3m 42s            IGMPv3
198.51.100.58      198.51.100.18     ppp-0/0/3/72339069014638597  vpn1
03h:38m:20s       3m 39s            IGMPv3
198.51.100.59      198.51.100.19     ppp-0/0/3/72339069014638597  vpn1
03h:38m:20s       3m 42s            IGMPv3
198.51.100.90      198.51.100.64     ppp-0/0/3/72339069014638597  vpn1
03h:38m:20s       3m 37s            IGMPv3
198.51.100.225     198.51.100.68     ppp-0/0/3/72339069014638597  vpn1
00h:35m:30s       3m 36s            IGMPv3
    
```

Example 5: Display detailed group information for specific group and source on all instances

```

supervisor@rtbrick>LEAF01: op> show igmp group 198.51.100.233 198.51.100.79
(198.51.100.79, 198.51.100.233)
  Outgoing interface      : null0
  Instance                 : vpn1
    
```



```

Source           : Static
State           : No Members Present
Version         : IGMP
Uptime         : 03h:42m:54s
Expires        : n/a
Membership interval : n/a
Last reporter   : n/a
Last member query count : n/a
Last member interval : n/a
Retransmit time : n/a
Max response time : n/a

```

## Example 6: Display detailed group information for specific group and source on all instances

```

supervisor@rtbrick>LEAF01: op> show igmp group outgoing-interface ppp-
0/0/3/72339069014638597
(198.51.100.51, 198.51.100.71)
  Outgoing interface      : ppp-0/0/3/72339069014638597
  Instance               : vpn1
  Source                 : Dynamic
  State                 : Members Present
  Version               : IGMPv3
  Uptime               : 00h:33m:44s
  Expires              : 1m 43s
  Membership interval   : 110s
  Last reporter        : 198.51.100.100
  Last member query count : 3
  Last member interval  : 1s
  Retransmit time      : 1s
  Max response time    : 0s
(198.51.100.51, 198.51.100.72)
  Outgoing interface      : ppp-0/0/3/72339069014638597
  Instance               : vpn1
  Source                 : Dynamic
  State                 : Members Present
  Version               : IGMPv3
  Uptime               : 00h:33m:49s
  Expires              : 1m 48s
  Membership interval   : 110s
  Last reporter        : 198.51.100.100
  Last member query count : 3
  Last member interval  : 1s
  Retransmit time      : 1s
  Max response time    : 0s
(198.51.100.53, 198.51.100.73)
  Outgoing interface      : ppp-0/0/3/72339069014638597
  Instance               : vpn1
  Source                 : Dynamic
  State                 : Members Present
  Version               : IGMPv3
  Uptime               : 00h:36m:12s
  Expires              : 3m 37s
  Membership interval   : 225s
  Last reporter        : 198.51.100.100
  Last member query count : 3
  Last member interval  : 1s
  Retransmit time      : 1s

```

```

Max response time      : 0s
(198.51.100.54, 198.51.100.74)
Outgoing interface    : ppp-0/0/3/72339069014638597
Instance              : vpn1
Source                : Dynamic
State                 : Members Present
Version               : IGMPv3
Uptime                : 00h:36m:12s
Expires               : 3m 41s
Membership interval   : 225s
Last reporter         : 198.51.100.100
Last member query count : 3
Last member interval  : 1s
Retransmit time       : 1s
Max response time     : 0s
(198.51.100.56, 198.51.100.115)
Outgoing interface    : ppp-0/0/3/72339069014638597
Instance              : vpn1
Source                : Dynamic
State                 : Members Present
Version               : IGMPv3
Uptime                : 03h:39m:02s
Expires               : 3m 38s
Membership interval   : 225s
Last reporter         : 198.51.100.100
Last member query count : 3
Last member interval  : 1s
Retransmit time       : 1s
Max response time     : 0s
    
```

Example 7: Display detailed group information for specific group and source on selected instance

```

supervisor@rtbrick>LEAF01: op> show igmp group instance vpn1 198.51.100.117
198.51.100.57
(198.51.100.57, 198.51.100.117)
  Outgoing interface    : ppp-0/0/3/72339069014638597
  Instance              : vpn1
  Source                : Dynamic
  State                 : Members Present
  Version               : IGMPv3
  Uptime                : 03h:39m:31s
  Expires               : 3m 34s
  Membership interval   : 225s
  Last reporter         : 198.51.100.100
  Last member query count : 3
  Last member interval  : 1s
  Retransmit time       : 1s
  Max response time     : 0s
supervisor@rtbrick>LEAF01: op>
    
```

## IGMP Clear Commands

## IGMP Interface

### Syntax:

**clear igmp interface** <attribute> <value>

Option	Description
<interface_name>	Clears the specified IGMP interface
instance <instance> statistics	Clears the IGMP interface statistics for the specified instance.

Example: Clear interface IGMP statistics

```
supervisor@rtbrick>LEAF01: op> clear igmp interface instance default statistics
Interface IGMP statistics were successfully cleared
supervisor@rtbrick>LEAF01: op>
```

## IGMP Group

### Syntax:

**clear igmp group** <attribute> <value>

Option	Description
all	Clear all IGMP groups present on all instances
instance <instance>	Clear all IGMP groups present on specific instance
interface <interface_name>	Clear all IGMP groups present on specific interface

Example: Clear all IGMP groups present on all instances

```
supervisor@rtbrick>LEAF01: op> clear igmp group all
IGMP groups were successfully cleared
supervisor@rtbrick>LEAF01: op>
```

## 14.2. PIM

## 14.2.1. PIM Overview

Protocol Independent Multicast (PIM) is a multicast routing protocol that runs over an existing unicast infrastructure. RBFS supports PIM source-specific multicast (SSM). PIM-SSM uses a subset of PIM sparse mode and IGMP version 3 (IGMPv3) to permit a client to receive multicast traffic directly from the source.

PIM SSM builds shortest-path trees (SPTs) rooted at the source immediately because in SSM, the router closest to the interested receiver host is informed of the unicast IP address of the source for the multicast traffic. That is, PIM SSM bypasses the RP connection stage through shared distribution trees, as in PIM sparse mode, and goes directly to the source-based distribution tree.

Internet Protocol Television (IPTV) is a service where digital TV signal data is delivered by using Internet protocol (IP). IPTV service networks typically use PIM-SSM as the multicast routing protocol which has the following characteristics:

- Source specific host membership report for a particular multicast group. IGMPv3 allows a host to describe specific sources from which it would like to receive data.
- PIM shortest path forwarding. Source-specific host report for a particular multicast group and initiating PIM (S,G) joins directly and immediately as result.
- No shared tree forwarding. In order to achieve global effectiveness of SSM, all networks must agree to restrict data forwarding to source trees for some recognized group range. The address range 232.0.0.0/8 has been allocated by IANA for use by source specific multicast (SSM).

## Supported Platforms

Not all features are necessarily supported on each hardware platform. Refer to the *Platform Guide* for the features and the sub-features that are or are not supported by each platform.

## 14.2.2. PIM Configuration

### Configuration Hierarchy

The diagram illustrates the PIM configuration hierarchy.

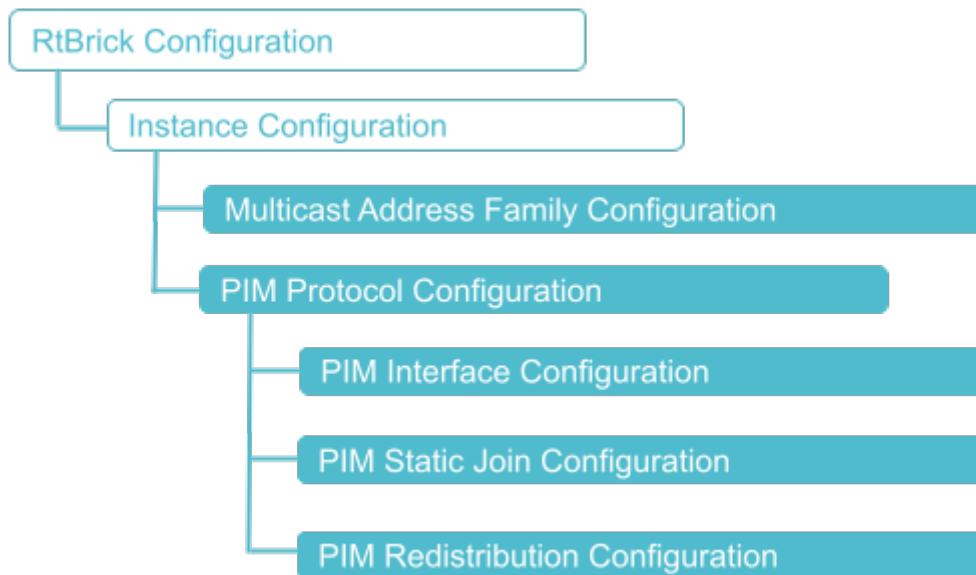

## Configuration Syntax and Commands

The following sections describe the interface configuration syntax and commands.

### Multicast Address Family Configuration

You can enable the multicast IPv4 address family under the PIM instance using the following command:

#### Syntax:

**set instance** <instance> **address-family** <attribute> <value>

Attribute	Description
<instance>	Specifies the name of the network instance
<afi>	Address family identifier (AFI). Supported values: ipv4
<safi>	Subsequent address family identifier (SAFI), that is, multicast.

#### Example: Multicast Address Family Configuration

```

{
  "rtbrick-config:address-family": [
    {
      "afi": "ipv4",
      "safi": "multicast"
    }
  ]
}

```

```
}
```

## PIM Protocol Configuration

### Syntax:

**set instance** <instance> **protocol pim** <attribute> <value>



If no instance is specified, PIM will be enabled on the default instance. RBFS supports only IPV4 address family.

Attribute	Description
<instance>	Specifies the name of the instance
afi <afi>	Address family identifier (AFI). Supported: ipv4
join-prune-interval <join-prune-interval>	PIM join & prune interval. The interval ranges from 10 to 600 seconds. By default, join & prune interval is 60 seconds and hold-down timer is 210 seconds.
sparse-mode interface <...>	Reference to an entry in the global interface list. Refer to section 2.2.1.1 for the PIM interface configuration.
sparse-mode static-join <...>	A static pim join, (*,G) or (S,G). Refer to section 2.2.1.2 for the PIM static join configuration.
sparse-mode redistribute <...>	Redistribution-related configuration. Refer to section 2.2.1.3 for the PIM redistribution configuration.

## PIM Interface Configuration

### Syntax:

**set instance** <instance> **protocol pim sparse-mode interface** <attribute> <value>

Attribute	Description
<instance>	Specifies the name of the instance
<interface-name>	Reference to an entry in the global interface list
afi <afi>	Address family identifier (AFI). Supported: ipv4
dr-priority <dr-priority>	Specifies the designated router (DR) priority value.

Attribute	Description
hello-interval <hello-interval>	Specifies the hello timer in seconds. The hello timer ranges from 1 to 3600 seconds. Default: 30 seconds.
override-interval <override-interval>	Specifies the override interval in milliseconds. Default: 2000 milliseconds.
propagation-delay <propagation-delay>	Specifies the propagation delay in milliseconds. Default: 500 milliseconds.

### Example: PIM Interface Configuration

```
{
  "rtbrick-config:interface": [
    {
      "interface-name": "ifl-0/0/0/1",
      "hello-interval": 100,
      "dr-priority": 101
    },
    {
      "interface-name": "ifl-0/0/1/2"
    },
    {
      "interface-name": "ifl-0/0/3/3",
      "propagation-delay": 103,
      "override-interval": 1000
    }
  ]
}
```

### PIM Static Join Configuration

#### Syntax:

**set instance** <instance> **protocol pim sparse-mode static-join** <attribute> <value>

Attribute	Description
<instance>	Specifies the name of the instance
<interface-name>	Reference to an entry in the global interface list
<outgoing-interface>	Multicast outbound interface name
<group-address>	Multicast group IP address
<source-address>	Multicast source IP address

## Example: PIM Static Join Configuration

```
{
  "rtbrick-config:static-join": [
    {
      "outgoing-interface": "ifl-0/0/0/1",
      "group-address": "198.51.100.12",
      "source-address": "198.51.100.120"
    }
  ]
}
```

## PIM Redistribution Configuration

### Syntax:

**set instance** <instance> **protocol pim sparse-mode redistribute** <attribute> <value>

### Command Parameters

<instance>	Specifies the name of the instance.
<afi>	Specifies the address family identifier. Supported value: ipv4.
<safi>	Specifies the subsequent address family identifier. Supported value: multicast.
<source>	Source protocol from which routes are being redistributed such as BGP or static.

## Example: PIM Redistribution Configuration

```
{
  "rtbrick-config:redistribute": [
    {
      "afi": "ipv4",
      "safi": "multicast",
      "source": "bgp"
    }
  ]
}
```

## PIM Configuration Example

```
{
  "rtbrick-config:pim": {
```



```

"sparse-mode": {
  "interface": [
    {
      "interface-name": "ifp-0/0/1"
    }
  ],
  "redistribute": [
    {
      "afi": "ipv4",
      "safi": "multicast",
      "source": "bgp"
    }
  ],
  "static-join": [
    {
      "outgoing-interface": "null0",
      "group-address": "198.51.100.110",
      "source-address": "198.18.73.250"
    },
    {
      "outgoing-interface": "null0",
      "group-address": "198.51.100.111",
      "source-address": "198.18.73.250"
    },
    {
      "outgoing-interface": "null0",
      "group-address": "198.51.100.112",
      "source-address": "198.18.73.250"
    },
    {
      "outgoing-interface": "null0",
      "group-address": "198.51.100.113",
      "source-address": "198.18.73.250"
    }
  ]
}
}
}

```

## 14.2.3. PIM Operational Commands

### PIM Show Commands

#### PIM Interface

##### Syntax:

**show pim interface** <option>

Option	Description
-	Without any option, the commands displays the information for all interfaces.

Option	Description
<interface_name>	Displays the PIM interface detail for the default instance
instance <instance_name>	Displays interface summary on specific instance

Example 1: Summary of PIM logical interface for all instances.

```

supervisor@rtbrick: op> show pim interface
Interface      Instance      IP Address      State      DR      Generator ID
ifl-1/7/1/1    default       198.51.100.247 Non-DR     198.51.100.42 1896236448
null0          default       n/a             n/a        n/a        n/a
ifl-0/0/3/3    vpn1          198.51.100.25  Non-DR     198.51.100.33 2123016228
    
```

Example 2: Summary of interfaces for the specified instance.

```

supervisor@rtbrick: op> show pim interface instance vpn1
Interface      Instance      IP Address      State      DR      Generator ID
ifl-0/0/3/3    vpn1          198.51.100.25  Non-DR     198.51.100.33 2123016228
    
```

Example 3: Detailed view of the specified PIM interface.

```

supervisor@rtbrick: op> show pim interface ifl-0/0/3/3
Interface: ifl-0/0/3/3
  Instance           : vpn1
  State              : Non-DR
  Primary address    : 198.51.100.25
  Generation ID      : 2123016228
  Timer values
    Hello interval   : 35s
    Join/Prune interval : 35s
    Hold interval    : 105s
    Override interval : 2000ms
    Prune delay interval : 500ms
  DR election
    DR address       : 198.51.100.33
    DR priority      : 1
    DR election count : 251
  Negotiated
    DR priority used : True
    Lan delay used   : False
    Lan prune interval : 0
    Lan override used : False
    Lan override interval : 0
  Statistics
    Hello
      Received       : 17214
      Sent           : 95
    Membership
      Received       : 0
      Sent           : 759
  Assert
    
```

```
Received      : 0
Sent         : 0
```

## PIM Membership

### Syntax:

**show pim membership** <option>

Option	Description
-	Without any option, the commands displays PIM membership summary on all instances.
instance <instance_name>	Displays the PIM membership summary information on specific instance.
detail	Detailed information on all BGP peers in all instances in a list view.
instance <instance_name> detail	Displays the PIM membership detailed information on specific instance.
<group_address>	Specifies the multicast multicast group address
<source_address>	Specifies the source from which the multicast traffic is received

Example 1: Summary of the PIM membership on all instances.

```
supervisor@rtbrick: op> show pim membership
Source      Group          Interface      Instance      Uptime
198.51.100.42  198.51.100.222  null0         default       00h:38m:05s
198.51.100.42  198.51.100.187  null0         default       00h:38m:05s
198.51.100.42  198.51.100.235  null0         default       00h:38m:05s
```

Example 2: Summary of the PIM membership for the specified instance.

```
supervisor@rtbrick: op> show pim membership instance default
Source      Group          Interface      Instance      Uptime
198.51.100.42  198.51.100.222  null0         default       00h:38m:18s
198.51.100.42  198.51.100.187  null0         default       00h:38m:18s
198.51.100.42  198.51.100.235  null0         default       00h:38m:18s
```

Example 3: Detailed view of PIM membership on all instances.

```
supervisor@rtbrick: op> show pim membership detail
```

```

198.51.100.42, 198.51.100.222
  Instance      : default
  Outgoing interface : null0
  Source        : pim
  Subtype       : Join
  Subsource     : Static
  Uptime        : 00h:39m:29s
198.51.100.42, 198.51.100.187
  Instance      : default
  Outgoing interface : null0
  Source        : pim
  Subtype       : Join
  Subsource     : Static
  Uptime        : 00h:39m:29s
198.51.100.42, 198.51.100.235
  Instance      : default
  Outgoing interface : null0
  Source        : pim
  Subtype       : Join
  Subsource     : Static
  Uptime        : 00h:39m:29s

```

Example 4: Detailed view of PIM membership for the specified instance.

```

supervisor@rtbrick: op> show pim membership instance default detail
198.51.100.42, 198.51.100.222
  Instance      : default
  Outgoing interface : null0
  Source        : pim
  Subtype       : Join
  Subsource     : Static
  Uptime        : 00h:39m:39s
198.51.100.42, 198.51.100.187
  Instance      : default
  Outgoing interface : null0
  Source        : pim
  Subtype       : Join
  Subsource     : Static
  Uptime        : 00h:39m:39s
198.51.100.42, 198.51.100.235
  Instance      : default
  Outgoing interface : null0
  Source        : pim
  Subtype       : Join
  Subsource     : Static
  Uptime        : 00h:39m:39s

```

Example 5: Detailed view of PIM membership for the specified group-address and source-address in selected instance.

```

supervisor@rtbrick: op> show pim membership instance default 198.51.100.222 198.51.100.42
198.51.100.42, 198.51.100.222
  Instance      : default
  Outgoing interface : null0
  Source        : pim
  Subtype       : Join

```

```

Subsource      : Static
Uptime        : 00h:39m:50s
supervisor@rtbrick: op>
    
```

## PIM Join and Prune

### Syntax:

**show pim join-prune** <option>

Option	Description
-	Without any option, the commands displays join and prune summary command on all instances.
instance <instance_name>	Displays join and prune summary on a specific instance.
detail	Displays PIM join and prune detailed information on all instances.
instance <instance_name> detail	Displays detailed join and prune information in selected instance.
<group_address>	Displays PIM join and prune detailed information for a specific group on all instance
<source_address>	Specifies the source from which the multicast traffic is received.

Example 1: Summary of the PIM join and prune all instances.

```

supervisor@rtbrick: op> show pim join-prune
Source          Group          Upstream Interface  Instance
198.51.100.42   198.51.100.222 ifl-1/7/1/1         default
198.51.100.42   198.51.100.187 ifl-1/7/1/1         default
198.51.100.42   198.51.100.235 ifl-1/7/1/1         default
198.51.100.11   198.51.100.22   ifl-0/0/3/3         vpn1
198.51.100.11   198.51.100.217 ifl-0/0/3/3         vpn1
    
```

Example 2: Summary of the PIM join and prune summary for the specified instance.

```

supervisor@rtbrick: op> show pim join-prune instance vpn1
Source          Group          Upstream Interface  Instance
198.51.100.11   198.51.100.22   ifl-0/0/3/3         vpn1
198.51.100.11   198.51.100.217 ifl-0/0/3/3         vpn1
198.51.100.33   198.51.100.23   ifl-0/0/3/3         vpn1
    
```

```
198.51.100.40      198.51.100.24      ifl-0/0/3/3      vpn1
```

### Example 3: Detailed view of the PIM join and prune for the specified instance.

```
supervisor@rtbrick: op> show pim join-prune instance vpn1 detail
198.51.100.11, 198.51.100.22
  Instance           : vpn1
  Upstream interface : ifl-0/0/3/3
  Upstream neighbor  : 198.51.100.11
  Type               : Join
  Uptime             : 00h:01m:11s
198.51.100.11, 198.51.100.217
  Instance           : vpn1
  Upstream interface : ifl-0/0/3/3
  Upstream neighbor  : 198.51.100.11
  Type               : Join
  Uptime             : 00h:01m:11s
198.51.100.33, 198.51.100.23
  Instance           : vpn1
  Upstream interface : ifl-0/0/3/3
  Upstream neighbor  : 198.51.100.33
  Type               : Join
  Uptime             : 00h:03m:41s
198.51.100.40, 198.51.100.24
  Instance           : vpn1
  Upstream interface : ifl-0/0/3/3
  Upstream neighbor  : 198.51.100.40
  Type               : Join
  Uptime             : 00h:03m:41s
198.51.100.66, 198.51.100.196
  Instance           : vpn1
  Upstream interface : ifl-0/0/3/3
  Upstream neighbor  : 198.51.100.66
  Type               : Join
  Uptime             : 00h:55m:31s
198.51.100.70, 198.51.100.197
  Instance           : vpn1
  Upstream interface : ifl-0/0/3/3
  Upstream neighbor  : 198.51.100.70
  Type               : Join
  Uptime             : 00h:55m:30s
198.51.100.80, 198.51.100.198
  Instance           : vpn1
  Upstream interface : ifl-0/0/3/3
  Upstream neighbor  : 198.51.100.80
  Type               : Join
  Uptime             : 00h:55m:30s
198.51.100.38, 198.51.100.199
  Instance           : vpn1
  Upstream interface : ifl-0/0/3/3
  Upstream neighbor  : 198.51.100.38
  Type               : Join
  Uptime             : 00h:55m:31s
198.51.100.200, 198.51.100.210
  Instance           : vpn1
  Upstream interface : ifl-0/0/3/3
  Upstream neighbor  : 198.51.100.200
  Type               : Join
```

```
Uptime : 00h:55m:31s
```

Example 4: Detailed view of the PIM join and prune for the specified instance, source, and group.

```
supervisor@rtbrick: op> show pim join-prune instance vpn1 198.51.100.210 198.51.100.200
198.51.100.200, 198.51.100.210
Instance           : vpn1
Upstream interface : if1-0/0/3/3
Upstream neighbor  : 198.51.100.200
Type               : Join
Uptime            : 00h:55m:50s
```

## PIM Neighbors

### Syntax:

**show pim neighbor** <option>

Option	Description
-	Without any option, the commands displays the PIM neighbor summary on all instances.
instance <instance_name>	Displays the PIM neighbor summary information on specific instance
instance <instance_name> <neighbor_address>	Displays detailed information for specific PIM neighbor in selected instance.

Example 1: Summary of PIM neighbor on all instances.

```
supervisor@rtbrick: op> show pim neighbor
Neighbor      Interface      Instance      Generation ID  Uptime      Expires
198.51.100.42 if1-1/7/1/1    default       1413290566    00h:55m:34s 1m 35s
198.51.100.11 if1-0/0/3/3    vpn1          666648646     00h:55m:59s 21s
198.51.100.37 if1-0/0/3/3    vpn1          1893441310    00h:55m:59s 28s
198.51.100.33 if1-0/0/3/3    vpn1          1582670973    00h:55m:56s 24s
198.51.100.40 if1-0/0/3/3    vpn1          2114142516    00h:55m:59s 21s
198.51.100.50 if1-0/0/3/3    vpn1          620803409     00h:55m:56s 29s
```

Example 2: Summary of PIM neighbor for the specified instance.

```
supervisor@rtbrick: op> show pim neighbor instance default
Neighbor      Interface      Instance      Generation ID  Uptime      Expires
198.51.100.42 if1-1/7/1/1    default       1413290566    00h:55m:41s 1m 28s
```

### Example 3: Detailed view of PIM neighbor for the specified instance.

```

supervisor@rtbrick: op> show pim neighbor instance default 198.51.100.42

Neighbor: 198.51.100.42
  Interface      : if1-1/7/1/1
  Instance       : default
  Hold down interval : 105s
  Expires        : 105s
  Generation ID   : 1413290566
  DR priority    : 1
  Uptime         : 00h:55m:47s
  Last transition time : Tue Nov 24 06:47:08 GMT +0000 2020
  Holddown received : 1
    
```

## PIM Reverse Path Forwarding (RPF)

### Syntax:

**show pim rpf** <option>

Option	Description
-	Without any option, the commands displays the PIM rpf summary information on all instance.
instance <instance_name>	Displays the PIM rpf summary information on specific instance.
instance <instance> <source_address>	Displays the PIM rpf detailed information for specific source-address in selected instance.

### Example 1: Summary of PIM rpf on all instances.

```

supervisor@rtbrick: op> show pim rpf
Multicast Source Instance      RPF Interface      Neighbor
198.51.100.42    default    if1-1/7/1/1      198.51.100.42
198.51.100.11    vpn1       if1-0/0/3/3      198.51.100.11
198.51.100.33    vpn1       if1-0/0/3/3      198.51.100.33
198.51.100.40    vpn1       if1-0/0/3/3      198.51.100.40
198.51.100.66    vpn1       if1-0/0/3/3      198.51.100.66
198.51.100.107   vpn1       n/a               n/a
    
```

### Example 2: Summary of PIM rpf for the specified instance.

```

supervisor@rtbrick: op> show pim rpf instance vpn1
Multicast Source Instance      RPF Interface      Neighbor
198.51.100.11    vpn1       if1-0/0/3/3      198.51.100.11
198.51.100.33    vpn1       if1-0/0/3/3      198.51.100.33
    
```



```

198.51.100.40    vpn1    ifl-0/0/3/3    198.51.100.40
198.51.100.66    vpn1    ifl-0/0/3/3    198.51.100.66
198.51.100.70    vpn1    ifl-0/0/3/3    198.51.100.70
198.51.100.107   vpn1    n/a             n/a
    
```

Example 3: Detailed view of PIM rpf for the specified source-address in selected instance.

```

supervisor@rtbrick: op> show pim rpf instance vpn1 198.51.100.11
Multicast source : 198.51.100.11
Instance         : vpn1
AFI              : ipv4
SAFI            : unicast
RPF interface    : ifl-0/0/3/3
Peer            : 198.51.100.11
Covering prefix  : n/a
MAC address      : 00:12:01:00:00:01
    
```

## PIM Routes

### Syntax:

**show pim mroute** <option>

Option	Description
-	Without any option, the commands displays the PIM routes summary information on all instance.
detail	Displays the PIM routes detail for all instances.
instance <instance_name>	Displays the PIM routes summary on specific instance
instance <instance_name> detail	Displays the PIM routes detailed information on specific instances.

Example 1: Summary of PIM routes for all instances.

```

supervisor@rtbrick: op> show pim mroute
Instance: default, AFI: ipv4, SAFI: multicast
Source          Group          Route Source  Preference  Nexthop      OIF
198.51.100.42   198.51.100.222 pim           240         n/a          null0
198.51.100.42   198.51.100.187 pim           240         n/a          null0
198.51.100.42   198.51.100.235 pim           240         n/a          null0
    
```

Example 2: Detailed view of PIM routes for all instances.

```

supervisor@rtbrick: op> show pim mroute detail
    
```

```

198.51.100.42, 198.51.100.222
  Source      : pim                Preference   : 240
  Sub source  : Static             Subtype     : Join
  RPF neighbor : 198.51.100.42    RPF interface : ifl-1/7/1/1
  Nexthop    : n/a                Egress interface : null0
  Nexthop type : Multicast Fanout  NextHop action  : None
  Destination : default-ipv4-multicast
  Resolved in : default-ipv4-multicast
198.51.100.42, 198.51.100.187
  Source      : pim                Preference   : 240
  Sub source  : Static             Subtype     : Join
  RPF neighbor : 198.51.100.42    RPF interface : ifl-1/7/1/1
  Nexthop    : n/a                Egress interface : null0
  Nexthop type : Multicast Fanout  NextHop action  : None
  Destination : default-ipv4-multicast
  Resolved in : default-ipv4-multicast
198.51.100.42, 198.51.100.235
  Source      : pim                Preference   : 240
  Sub source  : Static             Subtype     : Join
  RPF neighbor : 198.51.100.42    RPF interface : ifl-1/7/1/1
  Nexthop    : n/a                Egress interface : null0
  Nexthop type : Multicast Fanout  NextHop action  : None
  Destination : default-ipv4-multicast
  Resolved in : default-ipv4-multicast

```

Example 3: Summary of PIM routes for the specific instance.

```

supervisor@rtbrick: op> show pim mroute instance default
Instance: default, AFI: ipv4, SAFI: multicast
  Source      Group                Route Source Preference Nexthop      OIF
198.51.100.96 198.51.100.222 pim          240          n/a          null0
198.51.100.96 198.51.100.187 pim          240          n/a          null0
198.51.100.96 198.51.100.235 pim          240          n/a          null0

```

Example 4: Detailed view of PIM routes for the specified instances.

```

supervisor@rtbrick: op> show pim mroute instance default detail
198.51.100.96, 198.51.100.222
  Source      : pim                Preference   : 240
  Sub source  : Static             Subtype     : Join
  RPF neighbor : 198.51.100.96    RPF interface : ifl-1/7/1/1
  Nexthop    : n/a                Egress interface : null0
  Nexthop type : Multicast Fanout  NextHop action  : None
  Destination : default-ipv4-multicast
  Resolved in : default-ipv4-multicast
198.51.100.96, 198.51.100.187
  Source      : pim                Preference   : 240
  Sub source  : Static             Subtype     : Join
  RPF neighbor : 198.51.100.96    RPF interface : ifl-1/7/1/1
  Nexthop    : n/a                Egress interface : null0
  Nexthop type : Multicast Fanout  NextHop action  : None
  Destination : default-ipv4-multicast
  Resolved in : default-ipv4-multicast
198.51.100.96, 198.51.100.235
  Source      : pim                Preference   : 240
  Sub source  : Static             Subtype     : Join
  RPF neighbor : 198.51.100.96    RPF interface : ifl-1/7/1/1

```

```

Nexthop      : n/a                Egress interface : null0
Nexthop type : Multicast Fanout   NextHop action   : None
Destination  : default-ipv4-multicast
Resolved in  : default-ipv4-multicast
    
```

## PIM Clear Commands

Clear commands allow to reset operational states.

### PIM Neighbor

#### Syntax:

#### clear pim neighbor

Option	Description
neighbor	Clears all neighbors.

Example: The example below shows how to clear pim neighbor.

```

supervisor@rtbrick: op> clear pim neighbor
All instance clear triggered
    
```

### PIM Neighbor Instance

#### Syntax:

#### clear pim neighbor instance <option> ...

Option	Description
neighbor instance <instance_name>	Clears all neighbors on the specified instance.
neighbor instance <instance_name> interface <interface- name>	Clears all neighbors on the specified interface.

Example 1: The example below shows how to clear neighbors of the specified instance

```

supervisor@rtbrick: op> clear pim neighbor instance ip2vrf
    
```

```
Instance clear triggered
```

Example 2: The example below shows how to clear neighbors of the specified interface

```
supervisor@rtbrick: op> clear pim neighbor instance ip2vrf interface if1-0/0/0
Instance clear triggered
```

## 14.3. Multicast VPN

### 14.3.1. MVPN Overview

The Multicast VPN (MVPN) feature provides the ability to support multicast over a Layer 3 VPN. Multicast allows the efficient distribution of information between a single multicast source and multiple receivers. IP multicast is used to stream video, voice, and data to an MPLS VPN network core. The RBFS MVPN implementation is based on RFC 6513 “Multicast in MPLS/BGP IP VPNs” and RFC 6514 “BGP Encodings and Procedures for Multicast in MPLS/BGP IP VPNs”.

**i** | RFC and draft compliance are partial except as specified.

RBFS can operate in a spine/leaf fabric as shown in the diagram. The leaf device delivers access services to subscribers or assets, and the spine device provides connectivity to the core network. In such a scenario, IPv4 multicast traffic is carried in a multicast VPN instance. This also allows to deliver IPv4 multicast traffic across an IPv6-only fabric. In terms of MVPN, both leaf and spine devices act as Provider Edge (PE) routers.

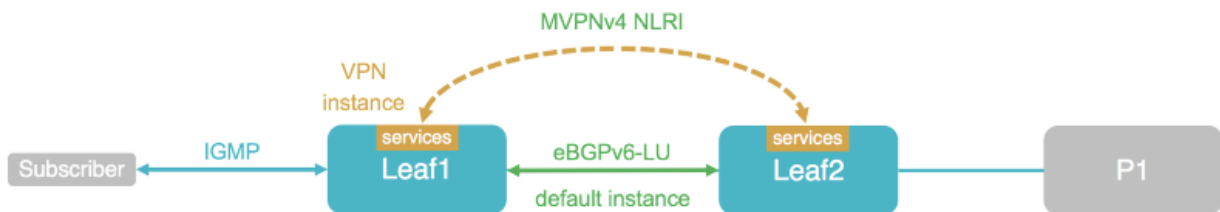

Multicast subscribers will typically join multicast streams via IGMP. Leaf switches will translate and signal the join messages to the spines using BGP MVPN routes. Spine switches will further forward the join messages towards the source to the upstream core router.

## Multicast Address Families

In MVPN, there are two types of instances that address families involved:

- Within the multicast VPN instance, joins are represented as multicast routes. These are AFI 1 (IPv4), SAFI 2 (Multicast). The IPv4 multicast address family needs to be enabled in the VPN service instance as well as for BGP in the VPN instance.
- In the Multicast VPN itself, messages like joins or active sources are advertised using BGP MVPN routes. These are AFI 1 (IPv4), SAFI 5 (MVPN). The BGP peerings that carry the MVPN routes typically run in the default instance. Therefore the MVPN address family needs to be enabled in the default instance, both for the BGP instance itself as well as for the BGP peerings.

In summary, the following address families need to be enabled by configuration:

- The IPv4 multicast address family in the VPN service instance.
- The IPv4 multicast address family for BGP in the VPN service instance.
- The Multicast VPN address family in the BGP default instance.
- The Multicast VPN address family in the BGP peerings in the default instance.

## Supported Platforms

Not all features are necessarily supported on each hardware platform. Refer to the *Platform Guide* for the features and the sub-features that are or are not supported by each platform.

### 14.3.2. MVPN Configuration

#### Configuration Hierarchy

The diagram illustrates the Multicast VPN configuration hierarchy.

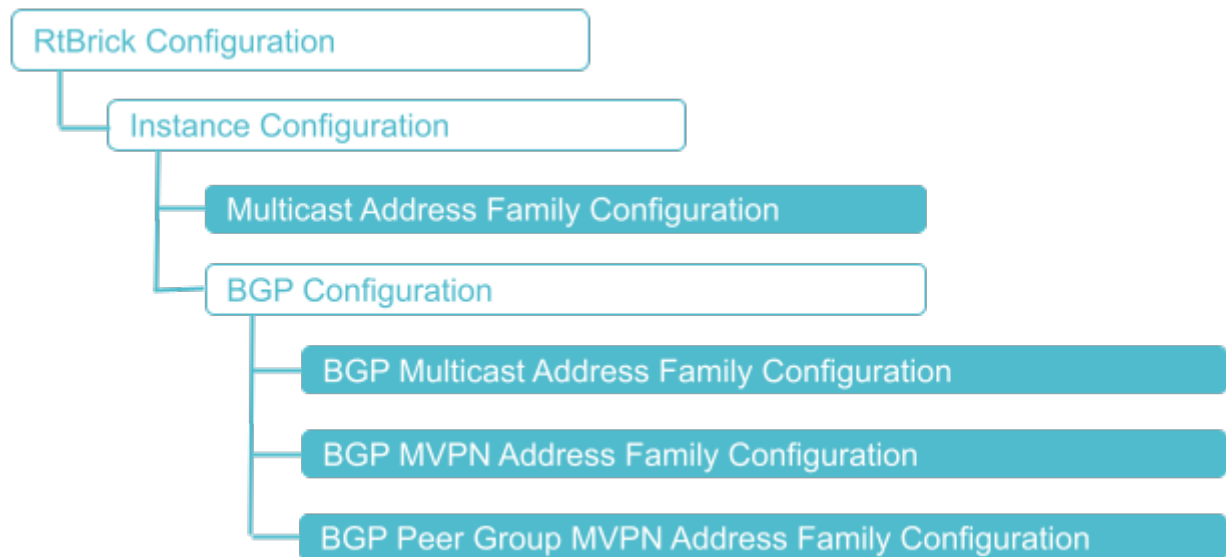

## Configuration Syntax and Commands

The following sections describe the MVPN configuration syntax and commands.

### Multicast Address Family Configuration

Enable the IPv4 multicast address family in the VPN service instance.

#### Syntax:

**set instance** <instance> **address-family** <afi> <safi> <attribute> <value>

Attribute	Description
<instance>	The name of the VPN service instance
<afi>	Address family identifier (AFI). For IPv4 multicast, the required value is: <b>ipv4</b>
<safi>	Subsequent address family identifier (SAFI). For IPv4 multicast, the required value is: <b>multicast</b>

#### Example: Instance Address Family Configuration

```

{
  "ietf-restconf:data": {
    "rtbrick-config:instance": [
      {
        "name": "services",
        "address-family": [
          {
            "afi": "ipv4",
  
```

```

        "safi": "multicast",
        "route-target": {
            "import": "target:198.51.100.10:13",
            "export": "target:198.51.100.10:13"
        }
    }
}
]
}
}
}

```

## BGP Multicast Address Family Configuration

Enable the IPv4 multicast address family for BGP in the VPN service instance.

### Syntax:

**set instance** <instance> protocol bgp **address-family** <afi> <safi> <attribute> <value>

Attribute	Description
<instance>	The name of the VPN service instance
<afi>	Address family identifier (AFI). For IPv4 multicast, the required value is: <b>ipv4</b>
<safi>	Subsequent address family identifier (SAFI). For IPv4 multicast, the required value is: <b>multicast</b>
redistribute <source>	Optionally redistribute PIM routes into BGP to translate and advertise subscriber join message as MVPN routes. The required source value is <b>pim</b> as IGMP routes are handled by the PIM process too.

### Example: Instance BGP Address Family Configuration

```

{
  "ietf-restconf:data": {
    "rtbrick-config:instance": {
      "name": "services",
      "protocol": {
        "bgp": {
          "address-family": [
            {
              "afi": "ipv4",
              "safi": "multicast",
              "redistribute": [
                {

```

```

        "source": "pim"
      }
    ]
  }
}
}
}
}
}

```

## BGP MVPN Address Family Configuration

Enable the MVPN address family in the global BGP instance.

### Syntax:

**set instance** <instance> **protocol bgp address-family** <afi> <safi> <attribute> <value>

Attribute	Description
<instance>	Name of the global BGP instance. Typically this will be the <b>default</b> instance.
<afi>	Address family identifier (AFI). For MVPN, the required value is: <b>ipv4</b>
<safi>	Supported SAFIs are unicast. For MVPN, the required value is: <b>vpn-multicast</b>

### Example: BGP MVPN Address Family Configuration

```

{
  "ietf-restconf:data": {
    "rtbrick-config:instance": [
      {
        "name": "default",
        "protocol": {
          "bgp": {
            "address-family": [
              {
                "afi": "ipv4",
                "safi": "vpn-multicast"
              }
            ]
          }
        }
      }
    ]
  }
}
}
}

```



## BGP Peer Group MVPN Address Family Configuration

Enable the MVPN address family for the global BGP peerings carrying the MVPN routes.

### Syntax:

**set instance** <instance> **protocol bgp peer-group** <attribute> <value>

Attribute	Description
<instance>	Name of the global BGP instance. Typically this will be the <b>default</b> instance.
<pg-name>	Peer group name
address-family <afi> <safi>	BGP peer group address family specific. For MVPN, the required AFI/SAFI values are: <b>ipv4/ vpn-multicast</b> .

### Example: BGP Peer Group MVPN Address Family Configuration

```
{
  "ietf-restconf:data": {
    "rtbrick-config:peer-group": [
      {
        "pg-name": "spine",
        "address-family": [
          {
            "afi": "ipv4",
            "safi": "vpn-multicast",
            "extended-nexthop": "true",
            "update-nexthop": {
              "ipv6-address": "2001:db8:0:103::"
            }
          }
        ]
      }
    ]
  }
}
```

## Multicast VPN Configuration Example

```
{
  "ietf-restconf:data": {
    "rtbrick-config:instance": [
      {
        "name": "default",
        "protocol": {
          "bgp": {
            "address-family": [
              {

```

```
        "afi": "ipv4",
        "safi": "vpn-multicast"
    }
],
"peer-group": [
    {
        "pg-name": "spine",
        "address-family": [
            {
                "afi": "ipv4",
                "safi": "vpn-multicast",
                "extended-next-hop": "true",
                "update-next-hop": {
                    "ipv6-address": "2001:db8:0:103::"
                }
            }
        ]
    }
]
},
{
    "name": "services",
    "address-family": [
        {
            "afi": "ipv4",
            "safi": "multicast",
            "route-target": {
                "import": "target:198.51.100.10:13",
                "export": "target:198.51.100.10:13"
            }
        }
    ]
},
"protocol": {
    "bgp": {
        "address-family": [
            {
                "afi": "ipv4",
                "safi": "multicast",
                "redistribute": [
                    {
                        "source": "pim"
                    }
                ]
            }
        ]
    }
}
]
```

### 14.3.3. MVPN Operational Commands

## Show Commands

### Syntax:

**show mroute ipv4 instance** <vpn-instance-name> <attribute> <value>

Option	Description
-	Without any option, the commands displays summary of all the multicast routes.
<vpn-instance-name>	Name of the VPN instance
detail	Displays detailed view of all the multicast routes.
group <group-address>	Multicast group address
source <source-address>	Multicast source address

### Example: Display Multicast Route Summary Information

```

supervisor@rtbrick: op> show mroute ipv4 instance services group 198.51.100.100/24
detail
Instance: services, AFI: ipv4, SAFI: multicast
198.51.100.250/24, 198.51.100.100/24
  Source: pim, Preference: 250
    Next Hop type: Multicast Fanout, Next Hop action: None
    Resolved in: services-ipv4-multicast
    Egress interface: null0
    
```

## MVPN Route Show Commands

### Syntax:

**show bgp fib ipv4 vpn-multicast instance default** <attribute> <value>

Option	Description
-	Without any option, the commands displays summary of all the multicast routes.
detail	Displays detailed view of all the VPN multicast routes.
<prefix>	Destination prefix address

### Example: Display MVPN Route Summary Information

```

supervisor@rtbrick: op> show bgp fib ipv4 vpn-multicast instance default
    
```

Instance: default, AFI: ipv4, SAFI: vpn-multicast

Group	Source	Preference	Out Label	Route Type
Next Hop				
-	-	20	20003,bos:1	Intra-AS_I-
PMSI_AD -	-	20	20003,bos:1	Intra-AS_I-
-	-	20	20003,bos:1	Intra-AS_I-
PMSI_AD -	198.51.100.111/24	198.51.100.2/24	20	20003,bos:1
Source_Tree_Join	-			

# 15. Security

## 15.1. Securing Management Plane

### 15.1.1. Securing the Management Plane Overview

The Securing Management Plane feature provides the capability to restrict the access to the management plane only to authenticated and authorized subjects.

The authentication identifies a subject, and the authorization validates if the subject is allowed to execute the action.

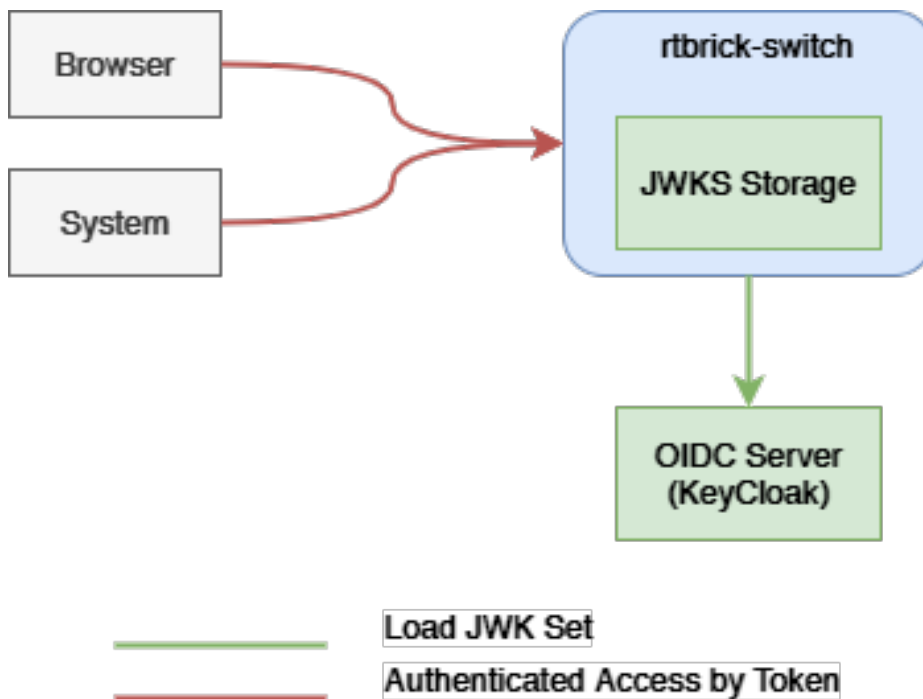

Figure 26. External Dataflow

The figure-1 shows the data flow when accessing an rtbrick-switch. Each call against the switch in more detail against the API Gateway Daemon (APIGWD) of the switch has to be authenticated with an access token. There is only one exception when accessing the CTLRD’s UI; it is possible to be redirected to an OpenIDConnect Authenticator.

The APIGWD validates the access token against an JSON Web Key Set (JWKS) (<https://tools.ietf.org/html/rfc7517>). This key set can be loaded from a file locally on the system or auto discovered via the OpenIDConnect server.

A valid access token, in the sense of syntactically correct but also successfully validated signature by one of the JSON Web Key of the JWKS files, leads in an authenticated user. If the validation is unsuccessful, the call will be rejected.

The access token contains scopes which are used internally for the authorization checks. The authorization is a role based authorization where the scopes equal to the roles.

Internally the access token is converted to an RtBrick token, and all the communications inside the switch is authenticated via this RtBrick token.

The dataflow inside of the switch can be seen in Figure 2.

The scopes of the access token are copied to the RtBrick Token.

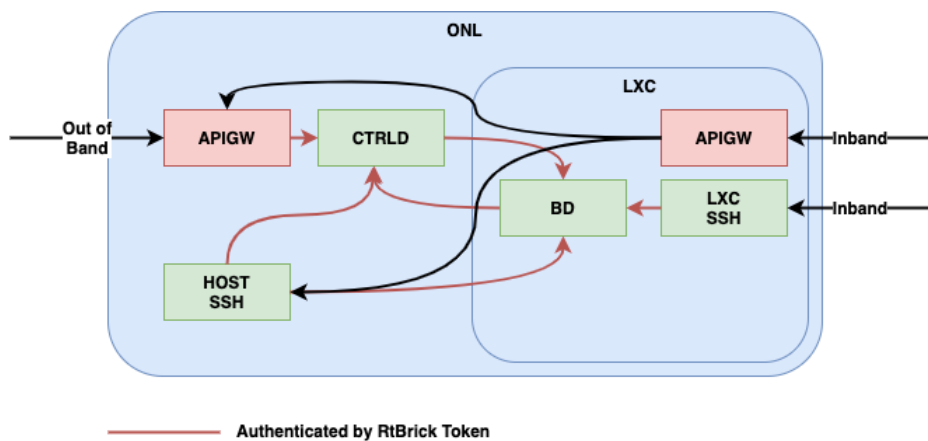

Figure 27. Internal Dataflow

## Supported Platforms

Not all features are necessarily supported on each hardware platform. Refer to the *Platform Guide* for the features and the sub-features that are or are not supported by each platform.

### 15.1.2. RtBrick Token

#### JSON Web Tokens

JSON Web Token (JWT) is an open standard (RFC 7519) that defines a compact and self-contained way for securely transmitting information between parties as a JSON object.

This information can be verified and trusted because it is digitally signed. JWTs can

be signed using a secret (with the HMAC algorithm) or a public/private key pair using RSA or ECDSA.



RFC and draft compliance are partial except as specified.

For more information about JSON Web Token, see <https://jwt.io/introduction/>.

## Structure

In its compact form, JSON Web Tokens consist of three parts separated by dots (.), which are:

- Header
- Payload
- Signature

Therefore, a JWT typically looks like the following.

```
xxxxxx.yyyyyy.zzzzzz
```

## Header

The header typically consists of two parts:

- The **type of the token**, which is JWT
- The signing algorithm that is being used, such as HMAC SHA256 or RSA

The suite of specifications on JWT provisions a few different options to identify particular cryptographic keys. The most straightforward mechanism is the "kid" claim. This claim can be added to the header of the token. It is intended to contain a string-based key identifier.

For example:

```
{
  "alg": "HS256",
  "typ": "JWT",
  "kid": "0815"
}
```

Then, this JSON is Base64Url encoded to form the first part of the JWT.

## Payload

The second part of the token is the **payload**, which contains the claims. Claims are statements about an entity (typically, the user) and additional data.

There are three types of claims:

- registered
- public
- private

### Registered claims

These are a set of predefined claims which are not mandatory but recommended, to provide a set of useful, interoperable claims. Some of them are: iss (issuer), exp (expiration time), sub (subject), aud (audience), and others.

### Public claims

These can be defined at will by those using JWTs. But to avoid collisions they should be defined in the IANA JSON Web Token Registry or be defined as a URI that contains a collision resistant namespace.

### Private claims

These are the custom claims created to share information between parties that agree on using them and are neither registered or public claims.

An example payload is as follows:

```
{
  "sub": "1234567890",
  "name": "John Doe",
  "iat": 1516239022,
  "exp": 1600000000,
  "scope": "user"
}
```

The payload is then Base64Url encoded to form the second part of the JSON Web Token.

## Signature

To create the signature part you have to take the encoded header, the encoded



payload, a secret, the algorithm specified in the header, and sign that.

For example if you want to use the HMAC SHA256 algorithm, the signature will be created in the following way:

```
HMACSHA256(  
  base64UrlEncode(header) + "." +  
  base64UrlEncode(payload),  
  secret)
```

The signature is used to verify the message wasn't changed along the way, and, in the case of tokens signed with a private key, it can also verify that the sender of the JWT is who it says it is.

## Putting all together

The output is three Base64-URL strings separated by dots that can be easily passed in HTML and HTTP environments.

## AccessToken

The Access Token is a JSON Web Token. The token is typically sent in the Authorization header using the Bearer schema. The content of the header should look like the following:

```
Authorization: Bearer <token>
```

The API Gateway also supports sending the token as Cookie, but this is not described here, that is only used for the CTRLD web UI.

The token has to have the **kid** claim in the header. This kid is used to find the right JSON Web Key (JWK) from one of the JSON Web Key Sets (JWKS).

APIGWD searches for the `jwtks` file under `/etc/rtbrick/apigwd/access_secret_jwtks.json`, but it is also possible to provide an additional oidc endpoint. By that the keysets are searched in the provided order:

- local file specified by command line `-access-token-jwks-file-name`
- oidc auto discovery `-oidc-issuer`

The scope claim contains the roles the user has. For example:

```
{
  "sub": "1234567890",
  "name": "John Doe",
  "admin": true,
  "iat": 1516239022,
  "exp": 1600000000,
  "scope": "user operator"
}
```

This user has the roles user and operator.

## JWKS Validation

The example below shows how to create a public/private key set file (for example with <https://mkjwk.org/>)

The screenshot shows the mkjwk.org interface with the following settings:

- Algorithm: RSA (selected), EC, oct, OKP
- Key Size: 2048
- Key Use: Signature
- Algorithm: RS256 (RSASSA-PKCS1-v1\_)
- Key ID: access
- Generate button

Example PubPrivJwks.json:

```
{
  "keys": [
    {
      "p": "-
      3WNqU2aWky8Q7mblRpw_aOknW47YvZKVNQz1Wdi jXW5E1hQ5c6sf jqo92pq5mNKJ_Xk171xHyp-WBfw-
      xJqZ9pUuG4 jnUiKgzyHvkccDF5XIMrpA67VnBozmyLckQOKEXesRD2hacr jB-
      T89dcIZQHBUK1RYXGRxHCM_hPeBok",
      "kty": "RSA",
      "q": "07STzbuUh6p_in2wzTegIQdnXBLnzPObCKt-KLSjkLtrZMv2YxM2yhMs-
      56SsLR7EICFRAB2vdCzlovXKShubU9NSKgVI38qpgV9hii8rqN5N3dEM4Gscp_TR36ex1NoSC6kHBF2hsy
      PfgD7U-txguZr6w9MN6rK4bAcg0TWGM0",
      "d": "IWcC4aKuPV1VGZeBhb3mla1m0s0cJuLxjpkZAu-
      QaQ07phWzeGLEfln3tojKtIK6e11FEz137ow75Je0_oMAzE-
      eTAMyseUTHZhn4LhmIdOwnsp90ZrMbNmLFpaF_rGYb0630xg27Gdr4gC_lZvMuy1uCP1sr8Iy1lujn7n_6
      ETMYbdXPLotEAB4Dag6XFTjy1l8aVvBxpsc8gKg64fgBGRvGY6PiUfqY3gaq_vX9SOOHVPN5WoShKA4fg
      uxukRBiLLYNxDMDb3-h8pd1_fr2WayDzmcIXpxvVjRVZHt71C-
      0Uhap6eRDMQocZXih8IdNV8zHUF_LeciE36fIb3oQ",
      "e": "AQAB",
      "use": "sig",
      "kid": "access",
      "qi": "3His_DaBkf_r7uDx9-8BohOQPhcudT95XC9Wys5MrYIBtgqQi6IscHIqvtXFpjmPrey-
      ch07p9msOAB_T8j_mgl16UWOx6j4h_fyHEBOWrQfNemKng2Hs0uCrwp jgGf2eXzaBY8T9H1bF1TJAAARGh
      _PePBi-F-IfAxGayj4hiM",
      "dp": "NJuyYpZAt1KUJJsdkL6gCYPV3xrYj3iuTKYBCbYAH5j1P-
      CFUIS5mnBVdnmuYKGTivsgi55DysluapwmSZ2KnoMBXXNb6dwixjvr8hSvuex1MN-
      0mludTUqHMfDW3dhGFxwJuq57VcsFAnVPl2ZfQBmAGPyRa-r7mwZo0Jmzfk",
      "alg": "RS256",
      "dq": "XL-
      4IWIU6Hrh9OxrEP1VwiKkPcpqk3gGa_31_49kOXxiyH4zK6S3VECibHpEefYYFFq6B9jMLMzKYSJS2U1FU
      85yZWp-GFwL3_nRmeCgmBMMuilkIs3KeCrh58JoPoBrd4BN-rOqq_kDagQc-
```



```
uyv1siuNUOo9RdSE4cX2JIzlrjgoZmtcU-  
nq_I7S2QTkdro2e1wPZKktTMAoG6VjGb7ieIQ5XyLKNQt9PWSZ2sHkd85MxXMRUWUcrEagW6JrV3uixeT3  
QTZ3g9Y6Qb4XDPH3EXUoAHJ0V26rpqXDSB_nmNvI5CVvCUcaZLPYoSEzBUPa9NaFIBcg
```

The **apigwd** can decode that token and validates the token with the corresponding key in the specified JKWS file.

## OIDC Authentication

If you use OpenID Connect for Authentication, that the Token is generated by the OIDC Connect server.

It is important to understand how the validation of the tokens works. Either the JWKS file which corresponds to the OIDC server is located locally on the system, or the OpenID Connect Server (issuer) is specified.

The first configuration possibility we already discussed. If the oicd connect server is specified the server provides an endpoint where the clients can download the public keys.

As an example for this configuration of an oidc-issuer here an excerpt of:

*/etc/rtbrick/apigwd/config.json*

```
"oidc_issuer" : "http://<keycloak>/auth/realms/<real name>",  
"client_id" : "<client id>",  
"client_secret" : "<secret>",  
"redirect_url": "",
```

Specific information about the issuer can be found at <http://<keycloak>/auth/realms/<realm name>/well-known/openid-configuration>.

If you also specify the client secret and the client id, this allows the APIGWD to redirect to the login page of the OIDC server. This is needed for browser-based applications like CTRLD UI.

### 15.1.3. Role Based Access Control (RBAC)

Role Based Access Control (RBAC) is an approach to restrict the system access to authorized users. The authorization model is role-based. There will be three items in a role-based model: **sub**, **obj**, and **act**.

- **sub**: the user (role) that wants to access a resource.

- **obj**: the resource that is going to be accessed
- **act**: the operation that the user performs on the resource

The RBAC Data Model is implemented in RBFS, and it allows you to define Permission or User Roles to various type of resources.

The model contains:

- **Resource Type**: The type of resource we are talking about (for example, BDS Table, BDS Object, REST)
- **Resource**: The identifier of the Resource (for example, Table Name, Rest endpoints). Regular expressions are allowed.
- **Permissions**: Indicates the action that a user is allowed to perform on the resource. The Permissions are CRUD (Create, Read Update, Delete). The permission gets a semantic with respect to the resource type.
- **Role**: The role of a user who tries to access a resource.

## CTRLD Authorization Configuration

### Activate or Deactivate Authorization in CTRLD

```
"auth_disabled": true
```

It is possible to specify the permissions in CTRLD exactly in the way specified above.

Where sub is the role a user needs to have, obj species the url endpoint the user wants to reach, and act is the HTTP Method the user wants to call on the endpoint.

For example:

```
{
  "permissions": [
    {"sub": "supervisor", "obj": "/*", "act": ".*" },
    {"sub": "reader", "obj": "/*", "act": "GET"},
    {"sub": ".*", "obj":
"/api/v1/rbfs/elements/{element_name}/services/{service_name}/proxy/*", "act":
".*" }
  ]
}
```



- The user with the role supervisor is allowed to access all rest endpoints, and act on them with all HTTP methods.
- The user with the role reader is allowed to access all rest endpoints, but can only call the HTTP GET method.
- All authenticated users are allowed to access the proxy endpoint with all HTTP methods.

To configure that policy CTRLD offers 2 endpoints:

- PUT [/api/v1/ctrlld/authorization/permissions](#)
- GET [/api/v1/ctrlld/authorization/permissions](#)

Please refer to API Documentation for more information.

## RBFS Authorization configuration

### RBFS Role Configuration via REST

```
{
  "objects": [
    { "attribute": { "role": "operator", "permission": "create|read|delete",
"resource_regex": "global.*", "resource_type": "object" } },
    { "attribute": { "role": "operator", "permission": "create|read|delete",
"resource_regex": "global.*", "resource_type": "table" } }
  ],
  "table": { "table_name": "secure.global.rbac.authorization.config", "table_type":
"authorization_config_table" }
}

{
  "objects": [
    { "attribute": { "role": "user", "permission": "-|read|-", "resource_regex":
"global.*", "resource_type": "table" } },
    { "attribute": { "role": "user", "permission": "-|read|-", "resource_regex":
"global.*", "resource_type": "object" } }
  ],
  "table": { "table_name": "secure.global.rbac.authorization.config", "table_type":
"authorization_config_table" }
}
```

- **role** : Represents role in the system
- **resource\_type** : Represents resources in the RBFS (table|object).
- **resource\_regex** : Regex for the resources to be accessed.
- **permission** : Bitmap representing permissions to create, read and delete.

create | read | delete

Action	BDS Table	BDS Object
Create	Create a BDS Table	Create/Update a BDS Object
Read	Read Table Header Objects or Metadata	Read BDS Objects
Delete	Delete a BDS Object	Delete a BDS Object

## RBFS Authorization CLI Configurations

### Global user role configuration:

**set system authorization global role** <name> **rbac-permission** <resource-type> <resource-regex> **permission** <permission-map>

role	Represents role in the system
resource_type	Represents resources in the RBFS (table/object).
resource_regex	Regex for the resources to be accessed.
permission	<p>Bitmap representing permissions to create, read and delete.</p> <p>-/-/-</p> <p>-/-/delete</p> <p>-/read/-</p> <p>-/read/delete</p> <p>create/-/-</p> <p>create/-/delete</p> <p>create/read/-</p> <p>create/read/delete</p>

## Example

```
admin@rtbick: cfg> set system authorization global role admin rbac-permission
table global.* permission create/read/delete
```

### Lawful user role configuration

**set system authorization lawful role** <name> **rbac-permission** <resource-type> <resource-regex> **permission** <permission>

role	Represents lawful interceptor (LI) role in the system
resource_type	Represents resources in the RBFS (table/object).
resource_regex	Regex for the resources to be accessed.
permission	<p>Bitmap representing permissions to create, read and delete.</p> <p>-/-/-</p> <p>-/-/delete</p> <p>-/read/-</p> <p>-/read/delete</p> <p>create/-/-</p> <p>create/-/delete</p> <p>create/read/-</p> <p>create/read/delete</p>

## Example

```
admin@rtbick: cfg> set system authorization lawful role fbi rbac-permission table
local.* permission -/read/-
```

### 15.1.4. SSH with TACACS+

RBFS provides a custom pluggable authentication module that gets invoked by the



stock sshd on login. The necessary configurations are pre-installed on RBFS.

RtBrick-PAM, referred to as RTB-PAM helps in landing the TACACS authentication on the appropriate user in the Ubuntu container and helps in providing necessary details for the secure management plane feature.

Once the PAM client requests TACACS for the authentication, with successful authentication TACACS responds with a few RtBrick specific details.

```
{
  rtb-deny-cmds: "clear bgp peer"
  priv_lvl : some_level
}
```

On successful authentication, the RTB-PAM module creates a token (JWT) for the logged-in ssh user.

## RTB-PAM Token

Token created by the RTB-PAM module contains the same claims that are defined under the RtBrick Token section, and this token is signed with the `secret_jwks.json` key.

The `scope` claim in the `rtb-token` is derived from the Linux groups that the locally mapped user belongs to.

The deny commands are converted into the claim `rtb-deny-cmds`. Once the token is created, it is transferred to the environment variable.

```
setenv RTB_TOKEN = {
  "sub": "83692",
  "iat": 1516239022,
  "exp": 1517239022,
  "name": "Admin User",
  "preferred_username", "user1",
  "scope": "operator tacacs_priv_lvl_8"
  "rtb-deny-cmds": "^clear bgp peer"
}
```

After the RTB-PAM token is created, the CLI prompt appears. If a token is not created for the logged-in user, then the user cannot perform communication with the BD.



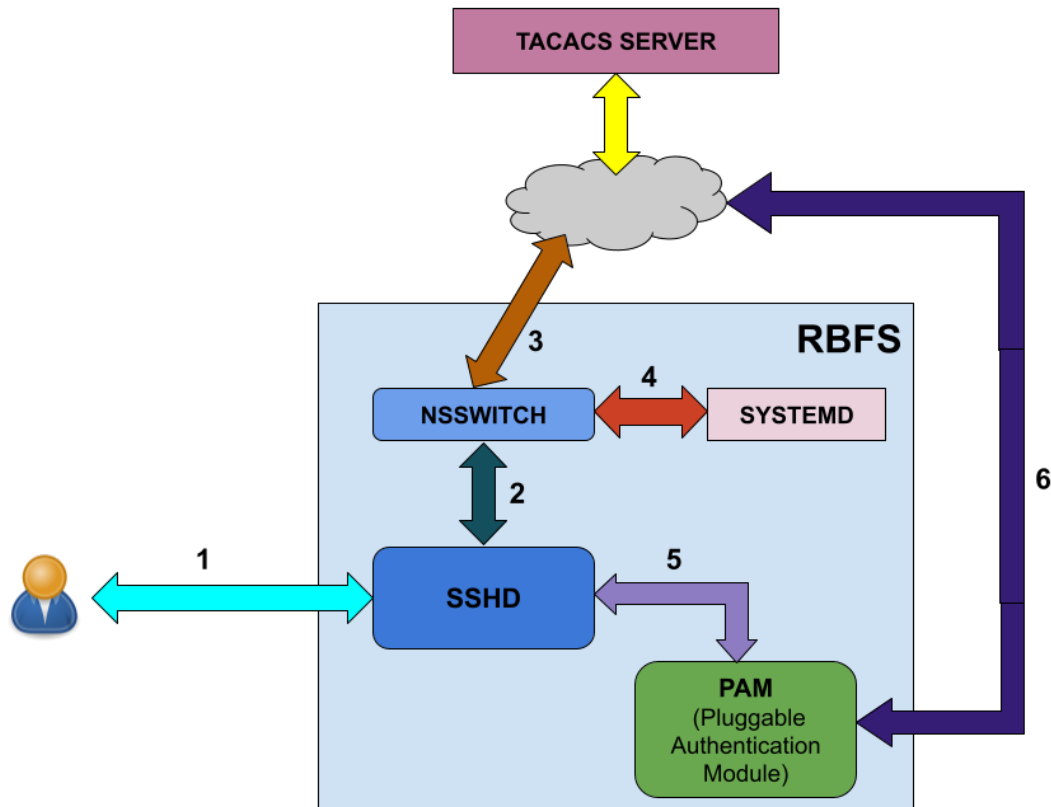

As shown in the figure above, the following steps are involved in the user login flow.

1. User starts to initialize using ssh
2. The SSH daemon (sshd) refers to the Name Service Switch (NSSWITCH) for user lookup
3. NSSWITCH performs a user lookup at the TACACS server



A user lookup happens at TACACS user database even for the local users, except for the user 'supervisor'.

4. If the user is not found at TACACS user database, then the user look up happens at the local user database.
5. User authentication is performed by PAM modules
6. PAM communicates to the TACACS server for authentication if it is a TACACS user

## Linux pre-configured users and groups

User Name	Group Name	Privilege
supervisor	supervisor	level 15
operator	operator	level 7-14
reader	reader	level 0-6

## In-Band and Out-of-Band TACACS user SSH Login

### In-band TACACS user SSH Login

A TACACS user can login using SSH to rtbrick container through inband management. RBFS should be configured with inband-management TACACS server for TACACS user login, and inband management configuration should be enabled with TACACS service.

### Out-of-band TACACS user SSH Login

TACACS user can login via SSH to ONL though out-of-band management. RBFS should be configured with out-of-band management TACACS server for TACACS user login.

## Configuring TACACS+ for RBFS

To configure TACACS+ server for RBFS, enter the the following commands.

### Syntax

```
set system authorization tacacs server-ip <IP address> type <management type> secret-plain-text <secret key>
```

```
set system authorization tacacs server-ip <IP address> type <management type> server-port <server port number>
```

### Command Arguments

<IP Address>	IP address of the TACACS Server
<management type>	in-band or out-of-band management

<IP Address>	IP address of the TACACS Server
secret-plain-text>	Secret plain text string. The secret string input can be plaintext format. If string starts with 1 then system considers it as encrypted string and stores key as it is. Also if secret string starts with 0, then system considers it as secret in plaintext and hence it stores in the system in encrypted format.
<server port number>	Server port number. This attribute is optional and by default system tries to connect to server running on port number 49.



For TACACS login to work with inband management, inband configuration must be enabled with the following command:  
**set inband-management instance <instance-name> tacacs true**

## Example

```
root@rtbrick:~# set system authorization tacacs 198.51.100.111 out-of-band
secret-plain-text testkey

root@rtbrick:~# set system authorization tacacs server-ip 198.51.100.101 type
inband server-port 1234
```



A TACACS user is not allowed to login without TACACS server configuration.

The example below shows the running configuration after you configure TACACS.

```
{
  "rtbrick-config:system": {
    "authorization": {
      "tacacs": [
        {
          "ipv4-address": "198.51.100.111",
          "type": "out-of-band",
          "secret-encrypted-text": "$202a74ca845585855b6f8df57cdf7858"
        }
      ]
    }
  }
}
```

## Example: TACACS User Configuration in the TACACS Server

The example below shows the server configurations for **rtb-deny-cmds**.

```
accounting file = /var/log/tac_plus.acct
key = tacacskey

user = bob {
    login = cleartext "bob"
    member = Network_Operator
}
group = Network_Operator {
    default service = permit
    service = exec {
        priv-lvl = 10
        rtb-deny-cmds = "show bgp.*"
    }
}
```



**priv-lvl** is a mandatory attribute in the TACACS user configuration.

Multiple `cmd-regexes` can be configured with each `regexes` separated by semicolon (;).

Example:

```
rtb-deny-cmds = "show bgp .*;show isis ."
```

## Troubleshooting NSS User Lookup Issues

To look up the TACACS username with all NSS methods, enter the following command:

```
ubuntu@rtbrick:~$ sudo getent passwd <tac_user>
```

To look up the local user within the local user database, enter the following command:

```
ubuntu@rtbrick:~$ sudo getent -s compat passwd <local_user>
```

To look up the TACACS user within the TACACS+ server database, enter the following command:

```
ubuntu@batman:~/development$ sudo getent -s tacplus passwd <tacuser>
```

If TACACS does not appear to be working correctly, You can enable debug logging by adding the `debug=1` parameter to one or more of these files:

```
/etc/tacplus_servers
/etc/tacplus_nss.con
```

## Configuring Secure Management Logs

### SSH User Login Logs

The transaction logs of users (in the PAM module) are available in the following log file:

```
/var/log/auth.log
```

Commands to enable secure-management logging:

Full Syntax	set log bd <bd_name> module secure_management logmap <log_map> level <log-level>
Parameter descriptions	
Command modes	
Behavior description	Enables secure-management logging in the system
Example	confd> set log bd all module secure_management logmap all level Info

## 15.2. Securing Control Plane

### 15.2.1. Securing the Control Plane Overview

#### Control Plane Traffic

Control plane security enables you to filter or rate-limit unwanted traffic that is transmitted from the forwarding plane to the control plane. In RBFS, you can use Access Control Lists (ACL) and policers to secure the router's control plane.

All routing protocols, management protocols, service protocols run in the control plane. The output of these protocols result in certain databases like routing table, MAC table, ARP table, etc., which eventually get programmed in the forwarding

plane.

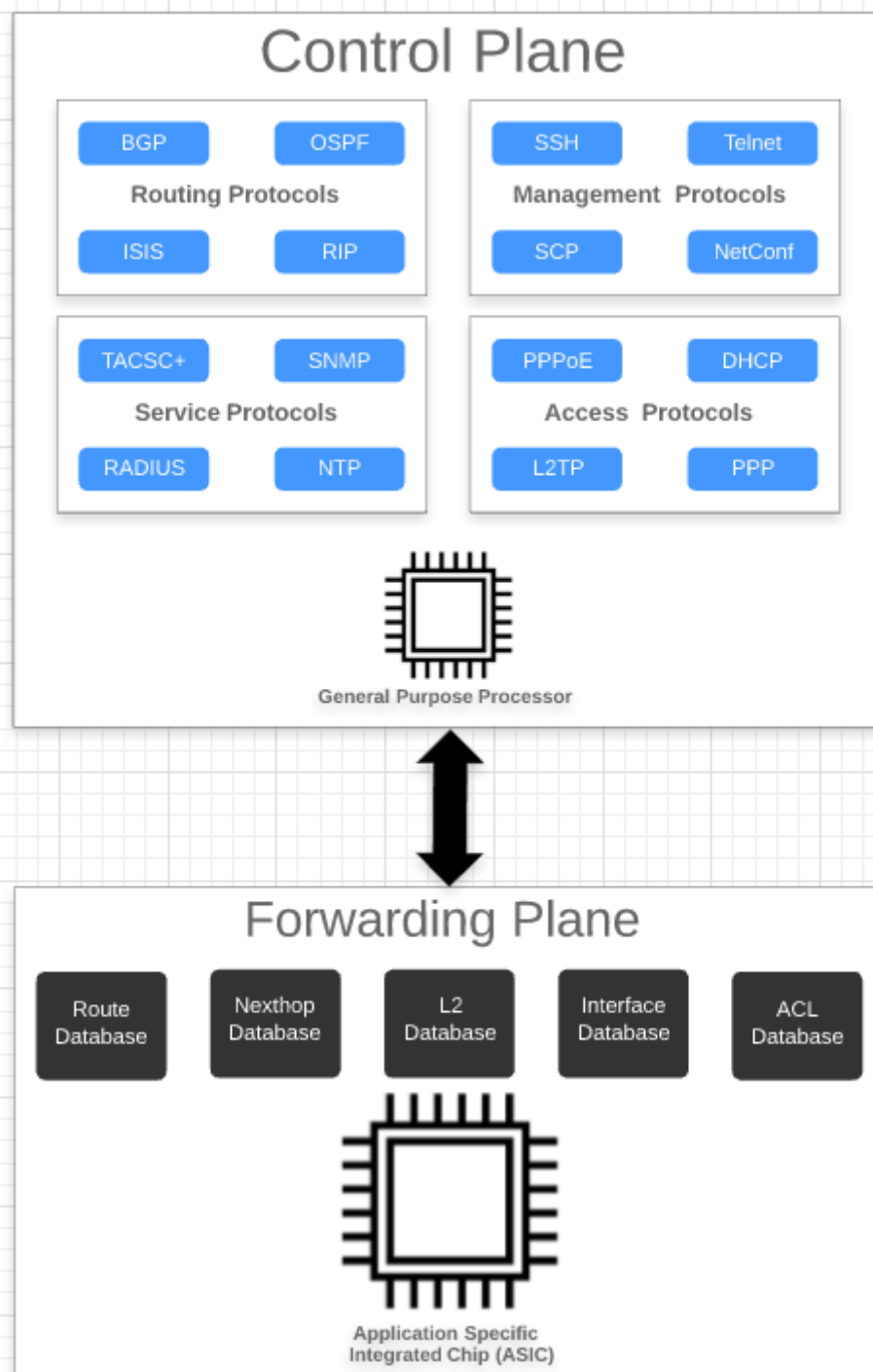

In the diagram above, you see the routing protocols (BGP, OSPF, ISIS), management protocols (SSH, RESTCONF, etc), service protocols (RADIUS, NTP, TACACS+), and access protocols (PPPoE, DHCP, L2TP, PPP) associated with the control plane. The control plane is generally implemented in software by using general-purpose processors. These protocols typically build a large number of databases like routing, switching, and ACL tables.

In contrast, a forwarding plane is associated with a copy of the databases (Routing,



Switching, ACL, etc) built by the control plane. These entries typically contain the **match** and **action** which decide the packet flow in the forwarding plane. The forwarding plane functionality is realized in high performance Application Specific Integrated Circuits (ASICs) that are capable of handling very high packet rates.

There are two kinds of traffic:

1. **Control traffic:** Control traffic is destined to the device itself, that means, packets are handled by the router itself. The traffic is classified as control traffic based on matching destination IP, or because of ACL rules, or because of some kind of exception that occurred while parsing the packet (non-acceptable fields, TTL expiry, etc).
2. **Transit traffic:** Transit traffic not destined to the device itself. These packets will be sent out on one of the routers physical interfaces.

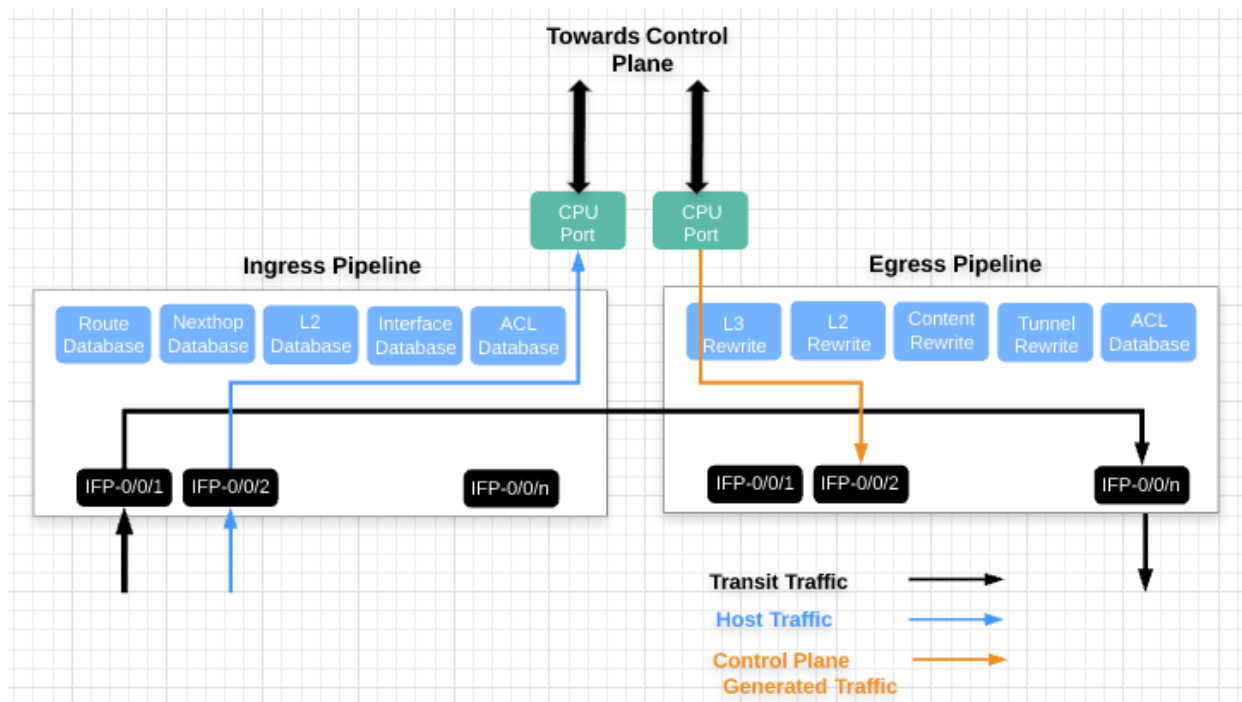

All control traffic packets will be destined to the CPU port(s). These packets are redirected to the control plane for further processing. However, general purpose processors in the control plane are not designed for packet processing, and might get overloaded if the rate of control plane traffic is too high, for example caused by a DDoS attack. Therefore you should to protect the router control plane by implementing mechanisms to filter completely or rate-limit traffic not required or unwanted at the control plane level.

## Securing the Control Plane

In RBFS, there are two fundamental mechanisms how control-plane traffic is redirected to the CPU:

1. Via protocol ACLs
2. Via route lookup

Both mechanisms need to be considered and secured separately, as described in the following sections.

### Control Plane Traffic via Protocol ACLs

All routing protocols (BGP, OSPF, ISIS), management protocols (SSH, RESTCONF, etc), service protocols (RADIUS, NTP, TACACS+), and access protocols (PPPoE, DHCP, L2TP, PPP), if enabled by configuration, automatically create Access Control Lists (ACLs) required to punt the protocol traffic to the control plane CPU. ACLs are the building block for securing the control plane. An ACL defines a rule, which typically contains match conditions and actions. If a packet matches the rule conditions, the associated actions will be applied. Protocol ACLs do not need to be defined by configuration. Another benefit is, they are very specific, for example match on auto-discovered IPv6 link-local neighbors. The protocol ACLs can be verified using the 'show acl (detail)' command.

#### Example 1: Protocol ACL created by LLDP

```
supervisor@rtbrick: op> show acl detail
Rule: lldp.ifp-0/0/1.trap.rule
  ACL type: l2
  Ordinal: -
  Match:
    Attachment point: ifp-0/0/1
    Direction: ingress
    Destination MAC: 01:80:c2:00:00:0e
  Action:
    Redirect to CPU: True
  Result:
    Trap ID: LLDP
<...>
```

#### Example 2: Protocol ACL created by RADIUS

```
supervisor@rtbrick: op> show acl detail
Rule: radius-srv1-v4-auth-trap
  ACL type: l3v4
```

```

Ordinal: -
Match:
  Source L4 port: 1812
  IP protocol: UDP
Action:
  Redirect to CPU: True
Result:
  Trap ID: Radius
<...>

```

By default, for most of the control protocols, there is a single action **Redirect to CPU: True**. Thereby all traffic matching the match criteria gets punted to the CPU without any rate limit. There is one exception, for PPPoE only the traffic is rate-limited by default. As shown in the following example, there is an additional action **Policer profile name:** created by default that limits the PPPoE traffic to 50 Mbps per session:

### Example 3: Protocol ACL with Policer created by PPPoE

```

supervisor@rtbrick: op> show acl detail
Rule: pppoed_hostif-0/0/1_7-7-1-4090_8863
ACL type: PPPOE
Ordinal: -
Match:
  Attachment point: if1-0/0/1
  Ethertype: 34915
Action:
  Redirect to CPU: True
  Policer profile name: _DEFAULT_POLICER_50_MB
Result:
  Trap ID: PPPoE
<...>

```

For all other protocols, rate limiting needs to be enabled by configuration in order to secure the control plane. This is described in section 2.1 below.

## Control Plane Traffic via Route Lookup

By default, any other traffic destined to one of the router's IP addresses, commonly referred to as "my IP", and not matching any ACL is redirected to the CPU via a route lookup. This applies to loopback as well as physical interface addresses. In order to secure the control plane against malicious traffic sent to one of the router's IP addresses (not matching any protocol ACL), ACLs need to be defined by configuration. In RBFS, such "manually" created ACLs are referred to as user-defined ACLs.

Typically you will want to completely block some unwanted traffic sent to "my IP",

but allow and rate-limit some required traffic like for example ICMP. Please note, when designing the security ACLs to protect "my IP", you do NOT need to consider the protocol traffic already handled by the protocol ACLs.

When configuring ACLs, protocol ACLs and user-defined ACLs may conflict. For example, an ACLs created by the BGP routing protocol might match on TCP traffic sent to the routers loopback address with port 179. A user-defined ACL however might deny any traffic sent to this loopback address. In this case, protocol ACLs shall take precedence over user-defined ACLs, so that you do not accidentally break the protocol operation. In RBFS, this is implemented using different ACL database priorities.

Configuring ACLs to protect "my IP" is described in section 2.2 below.

## Limitations and Notes

- The control-plane security features are supported on hardware platforms. They are not supported on virtual deployments.
- On the Edgecore AS5916-54XKS platform, BGPv6 with link-local peering uses route lookup instead of protocol ACLs. Therefore traffic sent to IPv6 link local addresses cannot be restricted via ACL to not break BGPv6 link-local peerings.

## Supported Platforms

Not all features are necessarily supported on each hardware platform. Refer to the *Platform Guide* for the features and the sub-features that are or are not supported by each platform.



Control Plane security is currently not supported for PIM, IGMP, and L2TP protocol traffic.

### 15.2.2. Control Plane Security Configuration

As highlighted above, there are two fundamental mechanisms how traffic is redirected to the CPU, via protocol ACLs, and via route lookup. These are addressed in following two sections.

#### Secure Control Plane Traffic via Protocol ACLs

This section describes the configuration options for control plane traffic that is

redirected to the CPU via protocol ACLs. These ACLs are automatically created by the protocols, and do not need to be - and cannot be - configured manually. For example if you configure a routing protocol like BGP, the required ACLs to match and punt the BGP packets to the control plane are created automatically.

## Enabling the Control Plane Security Feature

By default, all packets matching the protocol ACLs will be sent to the control plane without any rate limit, except for PPPoE. The RBFS Control Plane Security feature allows to add policers to all protocol ACLs. If enabled, this feature creates a set of default policers, and applies them to the protocol ACLs. Thereby the control plane gets secured against DDoS attacks matching these ACLs.

Syntax:

**set forwarding-options control-plane-security** <attribute> <value>

Attribute	Description
state (enable   disable)	Enable or disable the control-plane security feature. Default: enable.

Example:

```
{
  "rtbrick-config:forwarding-options": {
    "control-plane-security": {
      "state": "enable"
    }
  }
}
```

## Configuring Host Path QoS

The **host-path-qos enable** feature is disabled by default. Once it is enabled, you cannot disable it.

To enable the 'host-path-qos' feature, enter the following command:

Syntax:

**set forwarding-options class-of-service control-plane-qos ingress-qos**  
<attribute> <value>

Attribute	Description
state (enable   disable)	Enable or disable the host path QoS feature. Default: disabled.

## Example

```

supervisor@rtbrick>LEAF01: cfg> show config forwarding-options class-of-service
control-plane-qos
{
  "rtbrick-config:control-plane-qos": {
    "ingress-qos": {
      "state": "enable"
    }
  }
}

```

By enabling this feature, the default scheduler and queue configurations are installed and the CPU ports queue mapping will change. Also, all control plane ACLs will be reprogrammed to update `action_forward_class`.

### Marking Outbound Control Plane Traffic

RBFS enables you to configure the various protocols to mark the egress control plane traffic. The control plane traffic can be marked with type-of-service (ToS) values.



- For BGP, OSPF, RADIUS, PIM, L2TPv2, LDP, and DHCP protocols, the remark-type should be configured as ToS
- For the IGMP and PPPoE protocols, the remark-type can be configured as `p-bit` or `tos`
- The outbound-marking attributes such as name, code-point and remark-type are mandatory
- If the name of the protocol is L2-all, then the remark-type should be configured as `p-bit`
- If the name of the protocol is L3-all, then the remark-type should be configured as `tos`
- Redundancy related control traffic can be marked with specific `tos` value with the L3-all option

```
set forwarding-options class-of-service control-plane-qos outbound-
marking protocol <protocol-name> <remark-type-value> codepoint
<codepoint-value>
```

Option	Description
<protocol-name>	Specifies the protocol name.
<remark-type-value>	Specifies the remark type value that can be p-bit or tos.
<codepoint-value>	Specifies the codepoint value. The supported range for p-bit outbound-marking is 0-7.

## Example: Marking Outbound CP Traffic Configuration

```
supervisor@rtbrick>LEAF01: cfg> show config
{
  "ietf-restconf:data": {
    "rtbrick-config:forwarding-options": {
      "class-of-service": {
        "control-plane-qos": {
          "outbound-marking": {
            "protocol": [
              {
                "protocol": "bgp",
                "remark-type": "tos",
                "codepoint": 192
              },
              {
                "protocol": "dhcp",
                "remark-type": "p-bit",
                "codepoint": 5
              },
              {
                "protocol": "l3-all",
                "remark-type": "tos",
                "codepoint": 224
              },
              {
                "protocol": "igmp",
                "remark-type": "p-bit",
                "codepoint": 7
              },
              {
                "protocol": "igmp",
                "remark-type": "tos",
                "codepoint": 192
              }
            ]
          }
        }
      }
    }
  }
}
```

```

        "protocol": "ppp",
        "remark-type": "p-bit",
        "codepoint": 7
    },
    {
        "protocol": "ppp",
        "remark-type": "tos",
        "codepoint": 192
    },
    {
        "protocol": "radius",
        "remark-type": "tos",
        "codepoint": 100
    }
]
}
}
}
}
}
}

```

## Restricting Management Access

If you enable inband management access for example via SSH, protocol ACLs will be created that match on the enabled protocols and redirect the management traffic to the control plane. By default, this traffic is not restricted in terms of source IP addresses. You can optionally restrict management access to trusted IP addresses by applying a source prefix list. An additional match condition will then be added to the protocol ACLs for inband management.

## Configuring a Prefix List

Syntax:

**set forwarding-options prefix-list** <options>

Option	Description
<prefix-list-name> ipv4-prefix <ipv4_prefix>	Prefix list configuration for IPv4.
<prefix-list-name> ipv6-prefix <ipv6_prefix>	Prefix list configuration for IPv6.

## Applying a Prefix List

Syntax:



**set inband-management** instance <instance-name> source-prefix-list <list-name>

Example: Inband Management Configuration with Source Prefix List

```
"rtbrick-config:inband-management": {
  "instance": [
    {
      "name": "default",
      "ssh": "true",
      "ntp": "true",
      "source-prefix-list": "list1"
    }
  ]
},

"rtbrick-config:forwarding-options": {
  "prefix-list": [
    {
      "prefix-list-name": "list1",
      "ipv4-prefix": [
        {
          "ipv4-prefix": "198.51.100.100/24"
        },
        {
          "ipv4-prefix": "198.51.100.33/24"
        },
        {
          "ipv4-prefix": "198.51.100.44/24"
        }
      ]
    }
  ]
}
```



The inband management is provided to only the source address specified in the prefix list if the prefix list is configured. If the prefix list not configured, it works for all source IPs. Also, the prefix addresses configured should be of /32.

## Configuring Protocol ACL Options

This section describes how to configure policers per protocol and configure match on IPv4 ToS or IPv6 TC fields for protocol ACLs.



- If control plane security is disabled, this configuration has no effect in the system
- Protocol-specific configuration will take priority over ALL configuration in the control-plane-security protocol

Syntax:

**set forwarding-options control-plane-security protocol** <protocol-name>  
 <attribute> <value>

Option	Description
protocol <protocol-name>	Name of the protocol. You can configure individual protocols, and/or all protocols using the 'ALL' value keyword.
match-tc <tc-value>	Configure IPv6 TC value. The range is 0 to 248.
match-tos <tos-value>	Configure IPv4 ToS value. The range is 0 to 248.
policer <policer>	Configure policer name.

Example:

```
{
  "ietf-restconf:data": {
    "rtbrick-config:forwarding-options": {
      "class-of-service": {
        "policer": [
          {
            "policer-name": "_DEFAULT_POLICER_BGP_LL",
            "flags": "color-blind",
            "level1-rates": {
              "cir": 1000,
              "cbs": 1000,
              "pir": 1200,
              "pbs": 1000
            },
            "levels": 1,
            "type": "two-rate-three-color"
          }
        ]
      },
      "control-plane-security": {
        "state": "enable",
        "protocol": [
          {
            "protocol": "PIM",
            "policer": "_DEFAULT_POLICER_PIM",
            "match-tos": 192,
            "match-tc": 120
          }
        ]
      }
    }
  }
}
```

## Secure Control Plane Traffic via Route Lookup

This section describes the configuration to secure the control plane for traffic that is redirected to the CPU via route lookup. Any packet sent to one of the router's IP addresses ("my IP") and not matching any ACL, will be redirected to the CPU via route lookup. By default this type of traffic is not restricted or rate-limited. In order to secure the control plane, you need to apply ACLs by configuration. Please note you do not need to consider and allow any protocol traffic that is already captured by the automatically created protocol ACLs. You only need to explicitly define rules for any other traffic sent to "my IP". In the simplest case, you can deny any other traffic sent to the router. Typically you will want to allow some additional traffic like ICMP, and deny anything else.

### Configuring ACLs

This section describes how to configure ACLs to secure the control plane to protect "my IP". In RFBS, ACLs are applied globally, that is, you do not need to attach them by configuration. Besides, for ACLs matching traffic sent to one of the router's IP addresses, the `redirect-to-cpu` action applies implicitly and does not need to be configured.

Syntax:

**set forwarding-options acl** <options>

Option	Description
l3v4	ACL configuration for IPv4
l3v6	ACL configuration for IPv6
rule <rule-name>	Name of the ACL rule
ordinal <ordinal-value>	Number of the configuration entry. Please note the order of the configuration entries (ordinals) does not determine the processing.
match <condition>	Supported match conditions are IP source/destination prefix, prefix lists, source/destination Port, IP protocol, and direction.
action <action>	Supported actions are permit, drop, and police.

Option	Description
priority <value>	ACL entry priority. Determines the processing precedence for multiple matching i.e. conflicting rules. A less-specific rule should have a lower priority so that a more-specific rules takes precedence. Default: 10.

### Example 1: Denying any Traffic destined to the Router's Loopback Addresses

```

supervisor@rtbrick>LEAF01: cfg> show config forwarding-options acl
{
  "rtbrick-config:acl": {
    "l3v4": {
      "rule": [
        {
          "rule-name": "BLOCK_LOOPBACK_TRAFFIC_v4",
          "ordinal": [
            {
              "ordinal-value": 20,
              "match": {
                "destination-ipv4-prefix": "198.51.100.43/24",
                "direction": "ingress"
              },
              "action": {
                "drop": "true"
              },
              "priority": 20
            }
          ]
        }
      ]
    },
    "l3v6": {
      "rule": [
        {
          "rule-name": "BLOCK_LOOPBACK_TRAFFIC_v6",
          "ordinal": [
            {
              "ordinal-value": 20,
              "match": {
                "destination-ipv6-prefix": "2001:db8:0:10::/32",
                "direction": "ingress"
              },
              "action": {
                "drop": "true"
              },
              "priority": 20
            }
          ]
        }
      ]
    }
  }
}
supervisor@rtbrick>LEAF01: cfg>
    
```

## Example 2: ACL allowing and rate-limiting ICMPv4/v6, and denying any other Traffic

```

supervisor@rtbrick>LEAF01: cfg> show config forwarding-options acl
{
  "rtbrick-config:acl": {
    "l3v4": {
      "rule": [
        {
          "rule-name": "BLOCK_LOOPBACK_TRAFFIC_v4",
          "ordinal": [
            {
              "ordinal-value": 20,
              "match": {
                "destination-ipv4-prefix": "198.51.100.43/24",
                "direction": "ingress",
                "ip-protocol": "ICMP"
              },
              "action": {
                "permit": "true"
              },
              "priority": 20
            }
          ]
        }
      ]
    },
    "l3v6": {
      "rule": [
        {
          "rule-name": "BLOCK_LOOPBACK_TRAFFIC_v6",
          "ordinal": [
            {
              "ordinal-value": 20,
              "match": {
                "destination-ipv6-prefix": "2001:db8:0:10::/32",
                "direction": "ingress",
                "ip-protocol": "IPv6_ICMP"
              },
              "action": {
                "permit": "true"
              },
              "priority": 20
            }
          ]
        }
      ]
    }
  }
}

```

### 15.2.3. Control Plane Security Operational Commands

#### Show Commands

This section describes operational commands available to verify various control-

plane security features.

## Verifying ACLs

The **show acl** command allows to verify protocol ACLs as well as user-defined ACLs.

Syntax:

**show acl** <options>

Option	Description
detail	Displays all ACL details
<acl-name>	Displays the details for a single ACL

### Example 1: Protocol ACL with Control-Plane Security enabled

```

supervisor@rtbrick>LEAF01: op> show acl detail

Rule: lldp.ifp-0/0/1.trap.rule
  ACL type: l2
  Ordinal: -
  Match:
    Attachment point: ifp-0/0/1
    Direction: ingress
    Destination MAC: 01:80:c2:00:00:0e
  Action:
    Redirect to CPU: True
    Policer profile name: _DEFAULT_POLICER_50_MB
  Result:
    Trap ID: LLDP
<...>
Rule: radius-srv1-v4-auth-trap
  ACL type: l3v4
  Ordinal: -
  Match:
    Source L4 port: 1812
    IP protocol: UDP
  Action:
    Redirect to CPU: True
    Policer profile name: _DEFAULT_POLICER_20_MB
  Result:
    Trap ID: Radius
<...>
    
```

### Example 2: ACL for Inband Management with Source Prefix List

```

supervisor@rtbrick>LEAF01: op> show acl detail

Rule: ifm.inband.mgmt.lo-0/0/0/1.ssh.client.v4.trap.rule.1
  ACL type: l3v4
    
```

```

Ordinal: 1
Match:
  Destination IPv4 address: 198.51.100.91
  Source IPv4 address: 198.51.100.92
  Source L4 port: 22
  IP protocol: TCP
Action:
  Redirect to CPU: True
Result:
  Trap ID: INBAND
    
```

### Example 3: User-defined ACL to Protect "my IP"

```

supervisor@rtbrick>LEAF01: op> show acl Protect-CP-v4

Rule: Protect-CP-v4
ACL type: l3v4
Ordinal: 1
Match:
  Direction: ingress
  Destination IPv4 prefix: 198.51.100.91/24
  Source IPv4 prefix: 198.51.100.90/24
  IP protocol: ICMP
Action:
  Permit: True
Result:
  Trap ID: User Defined
Ordinal: 2
Match:
  Direction: ingress
  Destination IPv4 prefix: 198.51.100.91/24
Action:
  Drop: True
Priority: 5
Result:
  Trap ID: User Defined
    
```

## Verifying ACL Counters

The "show acl statistics" command displays information about the ACL packet counters. The counters are useful to verify if the ACL rules actually match, and if potentially malicious traffic gets dropped.

Syntax:

### show acl statistics

#### Example 1: ACL statistics information

```

supervisor@rtbrick>LEAF01: cfg> show acl statistics
ACL                                     Units      Total
Accepted   Dropped
lldp.ifp-0/0/12.trap.rule             Packets    -      -
    
```

```

-
-
-                                     Bytes      -      -
lldp.ifp-0/0/16.trap.rule                Packets  -      -
-
-                                     Bytes      -      -
lldp.ifp-0/0/27.trap.rule                Packets  -      -
-
-                                     Bytes      -      -
lldp.ifp-0/0/53.trap.rule                Packets  -      -
-
-                                     Bytes      -      -
default_bgp_l4_trap_12::2_12::1_dst      Packets  12     12
0
-                                     Bytes      1353   1353
0
default_bgp_l4_trap_12::2_12::1_src       Packets  12     12
0
-                                     Bytes      1353   1353
0
default_bgp_l4_trap_12.0.0.2_12.0.0.1_dst Packets  12     12
0
-                                     Bytes      1353   1353
0
default_bgp_l4_trap_12.0.0.2_12.0.0.1_dst Packets  -      -
-
-                                     Bytes      -      -
default_bgp_l4_trap_12.0.0.2_12.0.0.1_src Packets  12     12
0
-                                     Bytes      1353   1353
0
default_bgp_l4_trap_12.0.0.2_12.0.0.1_src Packets  -      -
-
-                                     Bytes      -      -
supervisor@rtbrick: cfg>

```

## Example 2: Display ACL statistics information for the specified ACL

```

supervisor@rtbrick>LEAF01: cfg> show acl default_bgp_l4_trap_12.0.0.2_12.0.0.1_dst statistics
ACL                                     Units      Total
Accepted      Dropped
default_bgp_l4_trap_12.0.0.2_12.0.0.1_dst Packets    20       20
0
-                                     Bytes      1917    1917
0
default_bgp_l4_trap_12.0.0.2_12.0.0.1_dst Packets    -        -
-
-                                     Bytes      -        -
supervisor@rtbrick>LEAF01: cfg>

```

## Verifying Control Plane Policers

This command allows to view the policers created by the control-plane security feature.

Syntax:

**show qos policer** <options>



Option	Description
-	Displays all policers created by the control-plane security feature
<policer-name>	Displays information about the specified policer
counter	Displays all policer counters

Example 1: Display information of all policers created by the control-plane security feature

```

supervisor@rtbrick>LEAF01: cfg> show qos policer
Policer: _DEFAULT_POLICER_100_MB
Active: True, Type: two-rate-three-color, Levels: 1, Flags: -
  Level  CIR(Kbps)  PIR(Kbps)  CBS(KB)  PBS(KB)  Max CIR(Kbps)  Max PIR(Kbps)
  1      100000      100000     33000    33000    -              -
  2      -           -          -         -         -              -
  3      -           -          -         -         -              -
  4      -           -          -         -         -              -
Policer: _DEFAULT_POLICER_1_MB
Active: True, Type: two-rate-three-color, Levels: 1, Flags: -
  Level  CIR(Kbps)  PIR(Kbps)  CBS(KB)  PBS(KB)  Max CIR(Kbps)  Max PIR(Kbps)
  1      1000       1000      33000    33000    -              -
  2      -           -          -         -         -              -
  3      -           -          -         -         -              -
  4      -           -          -         -         -              -
Policer: _DEFAULT_POLICER_20_MB
Active: True, Type: two-rate-three-color, Levels: 1, Flags: -
  Level  CIR(Kbps)  PIR(Kbps)  CBS(KB)  PBS(KB)  Max CIR(Kbps)  Max PIR(Kbps)
  1      20000      20000     33000    33000    -              -
  2      -           -          -         -         -              -
  3      -           -          -         -         -              -
  4      -           -          -         -         -              -
Policer: _DEFAULT_POLICER_250_MB
Active: True, Type: two-rate-three-color, Levels: 1, Flags: -
  Level  CIR(Kbps)  PIR(Kbps)  CBS(KB)  PBS(KB)  Max CIR(Kbps)  Max PIR(Kbps)
  1      250000     250000    33000    33000    -              -
  2      -           -          -         -         -              -
  3      -           -          -         -         -              -
  4      -           -          -         -         -              -
Policer: _DEFAULT_POLICER_500_MB
Active: True, Type: two-rate-three-color, Levels: 1, Flags: -
  Level  CIR(Kbps)  PIR(Kbps)  CBS(KB)  PBS(KB)  Max CIR(Kbps)  Max PIR(Kbps)
  1      500000     500000    33000    33000    -              -
  2      -           -          -         -         -              -
  3      -           -          -         -         -              -
  4      -           -          -         -         -              -
Policer: _DEFAULT_POLICER_50_MB
Active: True, Type: two-rate-three-color, Levels: 1, Flags: -
  Level  CIR(Kbps)  PIR(Kbps)  CBS(KB)  PBS(KB)  Max CIR(Kbps)  Max PIR(Kbps)
  1      50000      50000     33000    33000    -              -
  2      -           -          -         -         -              -
  3      -           -          -         -         -              -
  4      -           -          -         -         -              -
Policer: _DEFAULT_POLICER_5_MB
Active: True, Type: two-rate-three-color, Levels: 1, Flags: -
  Level  CIR(Kbps)  PIR(Kbps)  CBS(KB)  PBS(KB)  Max CIR(Kbps)  Max PIR(Kbps)
  1      5000       5000      33000    33000    -              -
  2      -           -          -         -         -              -
  3      -           -          -         -         -              -
  4      -           -          -         -         -              -
supervisor@rtbrick>LEAF01: cfg>

```

## Example 2: Display information of a specific policer

```

supervisor@rtbrick>LEAF01: cfg> show qos policer Premium_Upstream_Hierarchical_Policer
Policer: Premium_Upstream_Hierarchical_Policer
Active: False, Type: two-rate-three-color, Levels: 4, Flags: color-blind
  Level   CIR(Kbps)   PIR(Kbps)   CBS(KB)   PBS(KB)   Max CIR(Kbps)   Max PIR(Kbps)
  ---    -
  1       1000        1200        1000      1000      -               -
  2       900         1000        1000      1000      -               -
  3       5000        5200        1000      1000      -               -
  4       6000        6200        1000      1000      -               -
    
```

## Example 3: Display information of policer counter

```

supervisor@rtbrick>LEAF01: cfg> show qos policer counter
Interface                               Level  Units      Total      Received   Dropped
-----                               -
ipv6_ll_prefix_acl                      1     Packets    48         48         0
                                       Bytes      6383      6383      0
ipv6_mcast_ff01_prefix_acl              1     Packets    48         48         0
                                       Bytes      6383      6383      0
ipv6_mcast_ff02_prefix_acl              1     Packets    48         48         0
                                       Bytes      6383      6383      0
ppp-0/1/28/72339069014638594            1     Packets    0          0          0
                                       Bytes      0         0         0
ppp-0/1/28/72339069014638594            2     Packets    0          0          0
                                       Bytes      0         0         0
ppp-0/1/28/72339069014638594            3     Packets    0          0          0
                                       Bytes      0         0         0
ppp-0/1/28/72339069014638594            4     Packets    0          0          0
                                       Bytes      0         0         0
pppoed_ifp-0/1/28_1-3500-1-35           1     Packets    48         48         0
                                       Bytes      6383     6383      0
pppoed_ifp-0/1/28_1-3500-1-35           1     Packets    48         48         0
                                       Bytes      6383     6383      0
pppoed_ifp-0/1/30_1-3500-1-35           1     Packets    48         48         0
                                       Bytes      6383     6383      0
pppoed_ifp-0/1/30_1-3500-1-35           1     Packets    48         48         0
                                       Bytes      6383     6383      0
    
```



The `show qos policer counter` command displays the policer-level counters for the subscribers. The packets that get dropped after the RPF check, are currently updated in the `local.bcm.q2c.trap.stats` table in FIBD.

## 15.3. Local User Management

### 15.3.1. Local User Management Overview

Local User Management enables you to create, manage, and secure the Linux local users and groups through the RBFS configuration. This enables you to manage users and groups in the following environments:

- In the RBFS container only for the virtual platform
- In the RBFS container and on the ONL host for the hardware platforms

## Supported Platforms

Not all features are necessarily supported on each hardware platform. Refer to the *Platform Guide* for the features and the sub-features that are or are not supported by each platform.

### 15.3.2. Local user management Configuration

RBFS allows you to create privileges that are configurable for user-defined and pre-defined roles. RBFS supports a combination of permit and deny regular expressions and a configurable default privilege to support both blacklisting and whitelisting of users. If both permit and deny command regular expressions match, the allow regular expression takes precedence.

## Creating Roles

To create a role, you need to configure the following:

- Configure role-based access control (RBAC) privilege for the role
- Configure the command privilege for the role



It is important to have secure management enabled when granting any type of privilege, whether it is RBAC or command-based, to any user. Without secure management, privileges do not work.

For information about enabling Secure Management, see the section "Configuring Secure Management Logs" of the *Securing Management Plane* user guide.

## Configuring the RBAC Privilege

You need to configure the RBAC privilege for both table and object.

```
set system authorization global role <name> rbac-permission ( object | table ) <resource> <permission-type>
```

## Command arguments

<name>	Authorization role name
<resource>	Represents resources in the RBFS (table/object)
<permission-type>	Permissions to create, read and delete. The following are the supported RBAC permission types: -/-/ -/-/delete -/read/ -/read/delete create/-/ create/-/delete create/read/ create/read/delete

## Configuring the Command Privilege

```
set system authorization global role <name> cmd-permission ( allow-  
cmds <allow-cmds> | deny-cmds <deny-cmds> )
```

<role>	Authorization role name
<allow-cmds>	List of allow commands regular expression
<deny-cmds>	List of deny commands regular expression



- If you configure a privilege for any of the pre-defined roles (supervisor, operator, reader), then it replaces the default privilege.
- If you delete the configured privilege for a pre-defined role, then it will revert to the default privilege of the role.
- Priority of privilege rules is as follows: explicit deny, explicit permit, default privilege.

The example below shows the new role named "support" which has RBAC permission to read any table and objects. Also, the user is denied everything except the allowed commands (ping, set, show, traceroute, and watch-mode).

```

{
  "ietf-restconf:data": {
    "rtbrick-config:system": {
      "authorization": {
        "global": {
          "role": [
            {
              "name": "support",
              "rbac-permission": [
                {
                  "permission": "-/read/-",
                  "resource-type": "object",
                  "resource": ".*"
                },
                {
                  "permission": "-/read/-",
                  "resource-type": "table",
                  "resource": ".*"
                }
              ],
              "cmd-permission": {
                "allow-cmds": [
                  "ping .*",
                  "set .*",
                  "show .*",
                  "traceroute .*",
                  "watch .*"
                ],
                "deny-cmds": ".*"
              }
            }
          ]
        }
      }
    }
  }
}
    
```

## Linux pre-configured users, roles and privileges

User Name	Role Name	Default Privileges
supervisor	supervisor	Allow all actions
operator	operator	Allow all actions

User Name	Role Name	Default Privileges
reader	reader	<p>All commands will be denied other than the commands which match any of the below regular expressions.</p> <pre>"color.*", "date.*", "exit.*", "history.*", "paging.*", "ping.*", "show.*", "traceroute.*", "watch-mode.*"</pre>

## Creating New Users

The new users created through local user management will always have a primary group with the same name and ID of the created user. The new user’s ID will be allocated within the range of 3000 and 3999.



You cannot use usernames such as **root**, **wheel**, **admin**, **sudo** or any of the SMP Linux pre-configured users and groups such as **supervisor**, **operator**, **reader**. Also, a username cannot start with “rtbrick\_”. If a Linux user with the same username already exists but has an ID outside of the 3000-3999 range then the user creation through the RBFS configuration will fail.

To create a new user, enter the following command:

```
set system user <username>
```

## Command arguments

<username>	Name of the local user
------------	------------------------

## Assigning Roles to Users

A "role" is an RBFS RBAC construct and it is mapped to a Linux group. The list of user roles from the RBFS configuration becomes the list of additional Linux groups

that the Linux user belongs to. You can create new users and assign “roles” to the new users. The **supervisor**, **operator**, and **reader** are the pre-defined and pre-configured roles both in Linux and RBFS.

When a user is configured in RBFS under “system users”, RBFS/confd validates that the list of user roles only contain roles that are pre-defined or that are configured under “system authorization”.



Do not create role names that start with “rtbrick\_”. In addition, “root”, “wheel”, “admin”, and “sudo” are not acceptable role names.

To assign a role to a new user, enter the following command:

```
set system user <username> role <role>
```

## Command arguments

<username>	Name of the user
<role>	Role of the user (not the primary role)

### Example: Assigning Roles to Users

```
{
  "ietf-restconf:data": {
    "rtbrick-config:system": {
      "user": [
        {
          "username": "bob",
          "role": [
            "operator"
          ],
          "shell": "/usr/local/bin/cli",
          "password-hashed-text":
"$6$uTE40Yn0iRq.Vppe$JBVMQ5DZHfuCuUP5yTnfl9IJsRLQAXqTLlLMKRO8bCz9WDlB2ele8puwMrT4/
QDF2nNOcoHtqYqFljly4B.Vu0"
        }
      ]
    }
  }
}
```

## Configuring Authentication for a New User

There are two ways in which you can create a password for a new user in RBFS:

1. Creating hashed password
2. Creating plain-text password

### Creating Hashed Password

You can verify the integrity of your password using hashed passwords. When a user is present in the configuration but a "password hashed text" is not present, the password authentication is considered disabled for that specific user.

Three predefined roles include **supervisor**, **operator**, and **reader**. **supervisor** is the default password for the role supervisor. For the 'operator' and 'reader' roles, there is no default password.

Use the **system users supervisor** command to disable the default supervisor password.

You can also disable password authentication for any of the predefined users such as **supervisor**, **operator** and **reader** by adding a "system users supervisor" configuration section without any "password hashed text" and thus disabling password authentication for the supervisor user.

SSH public keys can be configured even if "password hashed text" is not present.

To create a password hashed text and authenticate the new user, perform the following steps:

1. Generate hash password on any Linux server.  
**mkpasswd --method=SHA-512**
2. Configure authentication using a password hashed text and an SSH public key.  
**set system user** <username> **password-hashed-text** <password-hashed-text>  
**set system user** <username> **ssh-pub-key** <ssh-pub-key>

### Changing an Existing Hashed Password for Supervisor

You can change an existing hashed password for a 'supervisor' user after logging in to the system.



**Syntax:**

**set system user** <username> **password-hashed-text** <password-hashed-text>  
**set system user** <username> **ssh-pub-key** <ssh-pub-key>

Example Command:

```
set system user supervisor password-hashed-text
$6$HIPXmd0uiLD0RtcT$3V7YxFJWR3b6NEGGd41RCT0TseWgdKLFAl6RecvDOqIUaCHMt0zo0ZZR4/1
```

**Command arguments**

<username>	Name of the user.
<password-hashed-text>	Password string.
<ssh-pub-key>	public keys of a user. You can specify multiple ssh-pub-keys.

3. Log in using username and password hashed text.



- It is possible to change shell, password-hash and ssh-pub-keys for supervisor, reader, and operator roles.
- The password string provided as part of the RBFS configuration needs to be a compatible password hashed text as defined by the shadow manual page: <https://manpages.debian.org/buster/passwd/shadow.5.en.html> and by the crypt <https://manpages.debian.org/buster/manpages-dev/crypt.3.en.html>.

**Example**

```
{
  "ietf-restconf:data": {
    "rtbrick-config:system": {
      "user": [
        {
          "username": "bob",
          "shell": "/usr/local/bin/cli",
          "password-hashed-text":
"$5$L2DaOYyddhBV$9RA5MX9RQzLC9fIKJzbnofBb88w9rkSXl7GVrVJ9PY7",
          "ssh-pub-key": [
            "ssh-rsa
AAAAB3NzaClyc2EAAAADAQCBAAABAQCubg5sdDycPN5EViNkV6w7rfp2GAfKWuInfal3xOXyvSNpsmaHIL
```

```
YmgrLUU0GKQH9gauPUJpDcvvYaMt0ZBuTbWHVMUc4cvhgbNDkTB2bG2cTZ5QzbiCyXff3B1DWQThVp2LtV
BiW2tf7JTTa9SnL4Lnm+CQcXsQ0rxqy2S6bJpsRY1FMyQ1/hZ4QEWE153dw0HGvcG8mjfnPN4wvCc/omfD
3ljxx+Gf4oFS0davX6pdphUKLvgL33VVG5xaK71imv2l3897LIJZaHxy7FbB+CjSYT6QNq1XksX8omrbRj
iP3enEQi/bANtzTNnGDnIm1KHf3xuKpoKw+B5fhDZogx"
    ]
  }
}
}
```

## Creating Plain-Text Password

To configure a password with plain text password for a new user, use the following command.

### Syntax:

**set system user** <username> **password-plain-text** <password-plain-text>

### Command arguments

<username>	Name of the user
<password-plain-text>	Specifies the plain-text password

## Example for Configuring Plain Text Password

```
set system user bob password-plain-text bob123
set system user bob shell /usr/local/bin/cli
set system user bob role operator
```

## Changing an Existing Plain-Text Password for Supervisor

You can change an existing plain text password for the 'supervisor' user after logging into the system. Use the following commands to change an existing password.

### Syntax:

**set system user** <username> **password-plain-text** <password-plain-text>

Sample Commands:

```
set system user supervisor shell /bin/bash
set system user supervisor password-plain-text rtbrick
```

## Viewing Configuration of Plain Text Password

```
{
  "ietf-restconf:data": {
    "rtbrick-config:system": {
      "user": [
        {
          "username": "bob",
          "role": [
            "operator"
          ],
          "shell": "/usr/local/bin/cli",
          "password-hashed-text":
"$6$uTE40Yn0iRq.Vppe$JBVMQ5DZHfuCuUP5yTnfl9IJsRLQAXqTL1LMKRO8bCz9WD1B2ele8puwMrT4/
QDF2nNOcoHtqYqF1jly4B.Vu0"
        }
      ]
    }
  }
}
```

## Setting the User Shell

RBFS validates that the shell is one of the following 3 valid options:

- /usr/sbin/nologin
- /bin/bash
- /usr/local/bin/cli

To configure user shell, enter the following command:

```
set system user <username> shell <shell>
```

## Command arguments

<username>	Name of the user
<shell>	Name of the shell

## Example

```
root@rtbrick: cfg> set system user smith shell /usr/local/bin/cli
```

## Specifying the Display Name for User Names

The display name allows you to specify a preferred name so that you can easily identify the user. You can change your display name by entering the following command:

```
set system user <username> display-name <display_name>
```

### Command arguments

<username>	Name of the user
<display_name>	Display name to easily identify the user

## Example

```
set system user smith display-name primeuser
```

## Enabling or disabling CLI access

You can control a user's access to the CLI. By default, users will have access to the CLI.

```
set system user <username> no-cli-access < true | false >
```

### Command arguments

<username>	Name of the user
<true   false>	When the no-cli-access is set to <b>true</b> , the user's access to the CLI is disabled. When the no-cli-access is set to <b>false</b> , the user will be able access the CLI.

## Example

```
set system user smith no-cli-access false
```

## Configuring sudo Without Password

You can configure local system users to log in via passwords or using SSH keys. From a security perspective, it is desirable to allow authentication with SSH keys only. RBFS provides a configuration knob to disable the requirement for a 'sudo' password so that local users can authenticate with SSH keys only. This knob is configurable only if the user or one of its roles is **supervisor**.

You can enter the following command to enable or disable the 'sudo' password. By default, this is set to false which ensures that the supervisor must provide a password when using sudo.

```
set system user <user> no-sudo-password < true | false >
```

## Command arguments

<username>	Name of the user
<true   false>	When the <b>no-sudo-password</b> is set to <b>true</b> , it indicates that a 'sudo' password is not required. When it is set to <b>false</b> , it indicates that the supervisor must provide a password when using sudo.

Example Configuration:

```
{
  "rtbrick-config:user": [
    {
      "username": "smith",
      "role": "supervisor",
      "shell": "/bin/bash",
      "ssh-pub-key": "ssh-rsa AAAAB3Nza<...>",
      "no-sudo-password": "true"
    }
  ]
}
```

Note: If 'no-sudo-password' is set, you can log in with your SSH key.

## Configuring Fail2Ban

The failed SSH login attempts from one user over an SSH jump host affect other users from the same jump host. You can configure Fail2Ban, which enables you to whitelist some IP addresses by creating separate jails for each user connecting through the jump host. In this way, failed login attempts by one user will not affect another user.

The following Fail2Ban command allows you to configure a list of IP addresses to include those IP addresses in the whitelist. You can specify multiple IP addresses that you want to exclude from the ban. Fail2Ban is applicable to both the ONL and the Linux container.

### Syntax:

```
set system platform-management fail2ban ignore-ip <ignore-ip>
```

### Command arguments

ignore-ip <ignore-ip>	Specify the IP addresses in CIDR notation which are to be whitelisted.
-----------------------	--

Example commands for configuration:

```
supervisor@rtbrick>LEAF01: cfg> show config set
set system
set system platform-management fail2ban ignore-ip 10.1.1.1/32
set system platform-management fail2ban ignore-ip 10.1.1.2/32
set system platform-management fail2ban ignore-ip 10.2.2.0/24
```

Example Configuration:

```
supervisor@rtbrick>LEAF01: cfg> show config
{
  "ietf-restconf:data": {
    "rtbrick-config:system": {
      "platform-management": {
        "fail2ban": {
          "ignore-ip": [
            "10.1.1.1/32",
            "10.1.1.2/32",
            "10.2.2.0/24"
          ]
        }
      }
    }
  }
}
```

```
}  
}  
}  
}
```

## 15.4. sFlow

### 15.4.1. RBFS sFlow Technology

#### sFlow Overview

sFlow is a packet-sampling protocol for monitoring network traffic. sFlow enables continuous, real-time monitoring of network traffic across all interfaces simultaneously. It works by collecting samples of data packets and transmitting these samples in UDP datagrams to a central station called collector.

The sampling process is directly handled by the networking processing ASIC, which ensures accuracy in packet sampling and also significantly reduces the utilization of control-plane resources such as CPU, memory.

sFlow provides insights into network traffic that enables the network operator to promptly identify performance issues, security threats, or unusual traffic patterns. It allows real-time network monitoring across thousands of router ports simultaneously in a large scale environment.

#### Packet-Based Sampling:

Packet-based sampling is a technique for capturing a subset of network traffic by selecting one packet from a predefined number of packets. It generates a representative sample of the overall traffic without capturing every packet, which would be resource-intensive.



RBFS sFlow mechanism captures only the packet headers passing through the incoming and outgoing physical interfaces.

#### Benefits of sFlow Technology

sFlow offers the following benefits:

**Detect Network Issues and Manage Real-time Congestion:** sFlow provides visibility into traffic patterns and enables the detection of anomalies such as

misconfigurations, packet loss, and latency and it can track unauthorized activities. It can monitor traffic flow and bandwidth usage in real-time and provides data to manage network congestion.

For example, if an RBFS device suddenly experiences high latency or packet loss, sFlow provides information to pinpoint the source of the issue, such as a faulty interface or a congested port.

**Types of Applications and Usage Patterns:** By analyzing packet headers, sFlow can identify different types of network traffic such as web browsing, peer-to-peer (P2P), and DNS queries. This helps you to understand the types of applications and the amount of bandwidth that they consume. It allows to track changes in resource usage.

For example, if a network experiences an increase in P2P traffic, sFlow can provide the cause and the users or applications that are involved. With this data, network administrators can take appropriate actions.

**Billing and Charge-Back:** sFlow can provide resource usage data on per-application or per-user basis, which is useful for enterprise customers that require billing or internal charge-back. Enterprises can utilize this data to accurately bill customers or to allocate costs to internal departments based on the actual network consumption.

**Route Profiling and Peering Optimization:** sFlow captures detailed routing information and traffic distribution that helps to analyze traffic patterns across different routes and optimize peering agreements. It helps to refine routing policies and peering relationships.

For example, service providers can use sFlow data to determine which peering partners receive most of the traffic. This information allows you to modify their peering policies to improve performance.

**Trends and Capacity Planning:** sFlow can provide data on traffic trends and bandwidth usage that helps you to increase capacity.

For example, you can see a particular link is nearing its bandwidth capacity by analyzing sFlow data. With this data, you can plan an upgrade.



## Understanding RBFS sFlow Implementation

sFlow works by capturing sample network packets and collecting data periodically to give a representative view of the overall traffic. It does not capture every packet, instead, it samples a subset of packets. For example, it captures one packet in every N packets (where N is configurable) on a physical interface.

### sFlow Components

An RBFS sFlow system comprises an sFlow agent embedded in a device and a remote sFlow collector.

#### sFlow Agent

The sFlow agent gathers data by sampling packets from the ports which are configured for sFlow. It then encapsulates this data into UDP datagram and sends the samples to the collector. The sFlow collector analyzes these samples to give you data about traffic patterns, issues, and performance of the network.

sFlow Agent is a key component and performs the following tasks:

1. Sampling to collect packet samples based on the defined number of packets
2. Process the collected packets
3. Export the UDP datagram to the sFlow collector

For sending the sampled packets, you can configure a destination port. The default destination port is 6343.

#### sFlow Collector

The collector receives the sampled data from the sFlow agents. It aggregates, processes, and stores the data for analysis. The collector can analyze and interpret metrics such as packet types, bandwidth usage, IP addresses, protocol information, and so on.

### Flow Sampling and Number of Samples

With the packet sampling, an sFlow agent samples packets on a designated interface based on a sampling rate that is set.

Each sFlow packet carries sampled data, and the number of samples determines

the amount of data included in a single packet. In RBFS, the number of samples in every sFlow packet by default is 1. It means each sFlow packet contains one sampled record.

## Guidelines for sFlow Settings

- To successfully transport sFlow data to the collector, make sure the routing table includes a route that enables communication with the collector's configured IPv4 address. Specifically, there should be a route entry for the collector's IPv4 address within the instance where the sFlow collector is configured. This ensures that the device knows the correct path to reach the collector's IP address within the specified routing instance, allowing sFlow data transit to the collector.
- The agent ID must be identical across all collectors configurations within a device. This ensures the source of sampled data is recognized as the same across multiple collectors.
- It is required to enable sFlow on each interface individually by attaching a traffic-sampling profile. This profile defines the collector IP address, sampling direction and so on.
- You can configure a maximum number of four different collectors to receive sampled traffic.

## Supported Platforms

Not all features are necessarily supported on each hardware platform. Refer to the *Platform Guide* for the features and the sub-features that are or are not supported by each platform.

### 15.4.2. sFlow Configuration

#### Configuration Hierarchy

The following diagram illustrates the sFlow configuration hierarchy. In this configuration hierarchy, traffic sampling collectors and traffic sampling profiles are set up under forwarding-options to enable packet sampling using the sFlow protocol. After defining the collectors and sampling profiles, the sampling profile can be attached to the physical interfaces that allows the device to sample traffic from that interfaces.

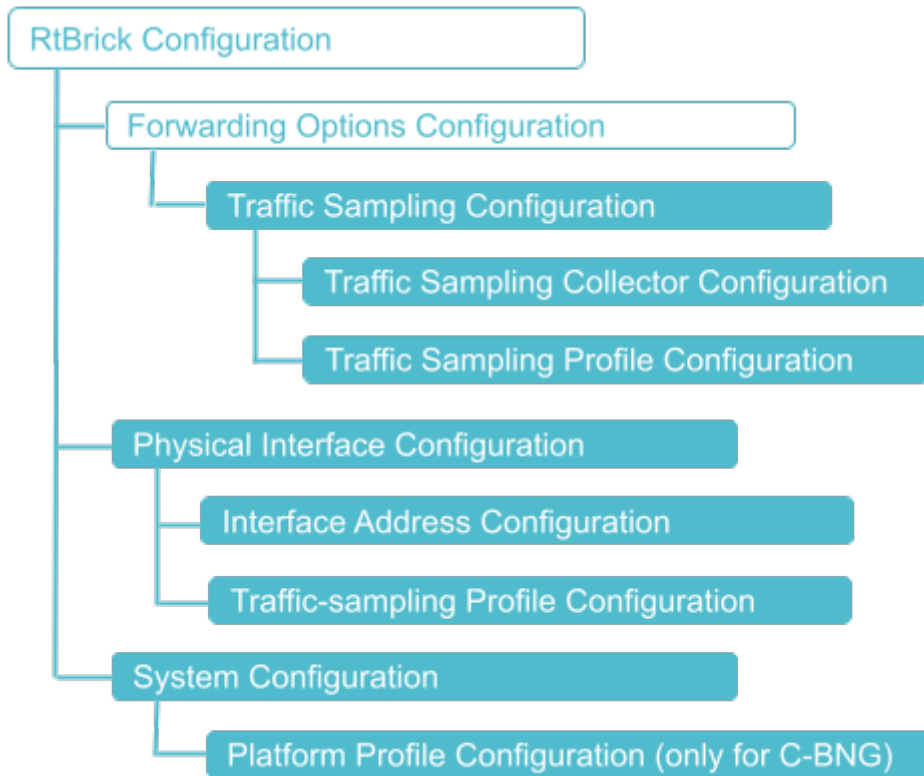

## Configuration Syntax and Commands

The following sections describe the sFlow configuration syntax and commands.

### Platform Profile Configuration

Platform Profile Configuration is applicable only to C-BNG devices. On Spine devices, Platform Profile configuration is not required.



The device must be rebooted after completing the Platform Profile configuration for it to take effect.

### Syntax

**set system platform profile** <profile-name>

Attribute	Description
profile_name	Name of platform profile
feature	Feature name.

Example commands:

```
set system platform profile nat_4q
set system platform profile nat_4q feature sFlow
```

```
supervisor@rtbrick.net: op> show config system platform
{
  "rtbrick-config:platform": {
    "profile": [
      {
        "profile_name": "nat_4q",
        "feature": [
          "sFlow"
        ]
      }
    ]
  }
}
```

## sFlow Collector Configuration

You can configure a maximum number of four collectors to receive sampled traffic.



The agent ID must be identical across all collectors. This ensures the source of sampled data is recognized as the same across multiple collectors.

You can create, modify, or delete collectors dynamically, while the device continues to operate. This gives you the flexibility to modify the configurations of the sFlow collectors without causing any downtime.

## Syntax

```
set forwarding-options traffic-sampling collector <collector-id> <attribute>
<value>
```

Example commands:

```
set forwarding-options traffic-sampling collector 1
set forwarding-options traffic-sampling collector 1 instance default
set forwarding-options traffic-sampling collector 1 export-protocol sflow
set forwarding-options traffic-sampling collector 1 address ipv4 10.1.1.1
set forwarding-options traffic-sampling collector 1 sampling-rate 100
set forwarding-options traffic-sampling collector 1 destination-udp-port 6343
set forwarding-options traffic-sampling collector 1 agent-id 1.2.3.4
```

Attribute	Description
collector-id	Identifier for each collector.
agent-id	Unique identifier for the device sending sFlow data. This ID must be the same across all collectors.
collector-ip	The IP address of the collector to which the sFlow UDP data gram is sent.
instance	The Instance of collector IP reachability.
destination-udp-port	The UDP port used for sending sFlow data to the collector (Default: 6343).
sampling-rate	Specifies the rate at which the packets are sampled. Range: 100 - 50,000. Example: When configured as 100, 1 packet out of 100 packets gets sampled.
export-protocol	The protocol for sending the captured sample packets to the collector (Protocol used is sFlow).

#### Example: Collector configuration

The following configuration sets up sFlow collectors. Each collector is assigned with a unique ID and is configured with an IP address to receive the sampled traffic, along with parameters like sampling rate, number of samples, and the destination UDP port for sFlow data. The same agent ID (1.2.3.4) is used for all collectors. The sampled traffic is sent to the collector's IP address, 10.1.1.1, over UDP port 6343. All collectors operate within the 'default' instance.

Collector 1 is configured with a sampling rate of '1' that indicates every packet traversing the configured interface is sampled without skipping any packet. The number of samples specified is 3, which indicates that the individual packets are aggregated into groups of three samples before being exported to the collector. The sFlow agent, which is the device or system sending the traffic samples, is defined by the agent identifier '1.2.3.4'.

In this configuration, collectors 2, 3, and 4 sample every 10th packet but differ in the number of samples and destination ports. Agent ID 1.2.3.4 is configured for all collectors 2, 3, and 4.

```
{
  "rtbrick-config:forwarding-options": {
    "traffic-sampling": {
```

```
"collector": [  
  {  
    "collector-id": 1,  
    "instance": "default",  
    "export-protocol": "sflow",  
    "address": {  
      "ipv4": "10.1.1.1"  
    },  
    "sampling-rate": 100,  
    "destination-udp-port": 6343,  
    "agent-id": "1.2.3.4"  
  },  
  {  
    "collector-id": 2,  
    "instance": "default",  
    "export-protocol": "sflow",  
    "address": {  
      "ipv4": "20.1.1.1"  
    },  
    "interval": 4,  
    "sampling-rate": 100,  
    "destination-udp-port": 6343,  
    "agent-id": "1.2.3.4"  
  },  
  {  
    "collector-id": 3,  
    "instance": "default",  
    "export-protocol": "sflow",  
    "address": {  
      "ipv4": "30.1.1.1"  
    },  
    "sampling-rate": 100,  
    "destination-udp-port": 6343,  
    "agent-id": "1.2.3.4"  
  },  
  {  
    "collector-id": 4,  
    "instance": "default",  
    "export-protocol": "sflow",  
    "address": {  
      "ipv4": "40.1.1.1"  
    },  
    "sampling-rate": 100,  
    "destination-udp-port": 6343,  
    "agent-id": "1.2.3.4"  
  }  
]
```

## Traffic-Sampling Profile Configuration

You can create a traffic sampling profile that can be attached to the physical interface .

## Syntax

**set forwarding-options traffic-sampling profile** <profile-name> **collector-id** <collector-id> **description** <description> **direction** [ingress\| egress\| both]

Example set of commands:

```
set forwarding-options traffic-sampling profile test
set forwarding-options traffic-sampling profile test collector 1
set forwarding-options traffic-sampling profile test direction ingress
set forwarding-options traffic-sampling profile test export-protocol sflow
```

Attribute	Description
profile-name	Name of the sampling profile.
collector-id	The identifier of the collector to which the packet samples are sent.
direction	Defines whether traffic sampling is performed on ingress, egress, or both of the directions.
description	Description for the profile.

Example: Traffic sampling profile configuration

This configuration defines two traffic sampling profiles that control how network traffic is sampled and exported to specific collectors using the sFlow protocol. Each profile focuses on capturing only incoming traffic on the monitored interfaces and exports this data to a designated collector for analysis.

The first profile, named "test", is configured to send the collected traffic data to Collector 1. This profile is designed to focus on incoming traffic.

The second profile, named "test1", has a similar configuration. It also monitors only incoming traffic, using the sFlow protocol to export the data. The traffic collected under this profile is directed to Collector 2.

```
{
  "rtbrick-config:forwarding-options": {
    "traffic-sampling": {
      "profile": [
        {
          "profile-name": "test",
          "collector": 1,
          "direction": "ingress",
        },
      ],
    },
  },
}
```

```

    {
      "profile-name": "test1",
      "collector": 2,
      "direction": "ingress",
    }
  ]
}
}
}

```

## Attach Traffic-Sampling Profile with the Physical Interface

You can attach a traffic sampling profile to a physical interface using the following command.

### Syntax

**set interface** <interface-name> **traffic-sampling-profile** <profile-name>

Example Command:

```
set interface ifp-0/1/10 traffic-sampling-profile test1
```

Attribute	Description
interface-name	Name of the physical interface.
<profile-name>	Name of the profile.

Example: Traffic sampling profile is attached on multiple physical interfaces.

This configuration sets up a few physical interfaces with different speeds. Some of these interfaces have traffic sampling profiles configured. Two interfaces (**ifp-0/1/10** and **ifp-0/1/8**) are configured with traffic sampling profiles ('test1' and 'test', respectively).

```

[
  {
    "name": "ifp-0/1/10",
    "speed": "10G",
    "traffic-sampling-profile": "test1",
    "unit": [
      {
        "unit-id": 1,
        "address": {
          "ipv4": [
            {
              "prefix4": "121.0.0.1/24"
            }
          ]
        }
      }
    ]
  }
]

```



```

        }
      ],
      "ipv6": [
        {
          "prefix6": "fc66:1337:7331::1/64"
        }
      ]
    }
  },
  {
    "unit-id": 25,
    "vlan": 25,
    "address": {
      "ipv4": [
        {
          "prefix4": "10.1.1.2/24"
        }
      ]
    }
  },
  {
    "unit-id": 26,
    "vlan": 26,
    "address": {
      "ipv4": [
        {
          "prefix4": "20.1.1.2/24"
        }
      ]
    }
  }
]
},
{
  "name": "ifp-0/1/20",
  "speed": "10G"
},
{
  "name": "ifp-0/1/26",
  "speed": "1G"
},
{
  "name": "ifp-0/1/5",
  "speed": "1G"
},
{
  "name": "ifp-0/1/6",
  "speed": "1G"
},
{
  "name": "ifp-0/1/61",
  "speed": "10G"
},
{
  "name": "ifp-0/1/63",
  "speed": "10G"
},
{
  "name": "ifp-0/1/8",
  "speed": "10G",
  "traffic-sampling-profile": "test"
}

```

```

    },
    {
      "name": "ifp-0/1/9",
      "speed": "10G"
    },
    {
      "name": "lo-0/0/4",
      "unit": [
        {
          "unit-id": 1,
          "address": {
            "ipv4": [
              {
                "prefix4": "1.2.3.4/24"
              }
            ]
          }
        }
      ]
    }
  ]
}
]

```

### 15.4.3. sFlow Operational Commands

#### sFlow Collector Information

The `show traffic-sampling sflow collector` command output provide details about the sFlow collectors configured on the device. It shows the information related to each collector, including its sampling rates, associated agent, destination IP address, and other configuration specifics.

#### Syntax:

**show traffic-sampling sflow profile** <profile-name> **collector** <collector-id>

Option	Description
<profile-name>	Name of the profile.
collector-id	Identifier for the collector.

#### Example 1: Summary Output for sFlow collectors

```

supervisor@rtbrick: op> show traffic-sampling sflow collector
Collector ID: 1
  Agent-ID: 1.2.3.4
  Address: 10.1.1.1
  Instance: default
  Number of samples: 5
  Sampling-rate: 10
  UDP-Destination-Port: 6343

```

```

Collector ID: 2
  Agent-ID: 1.2.3.4
  Address: 20.1.1.1
  Instance: default
  Sampling-rate: 10
  UDP-Destination-Port: 6343
  Interval: 4 secs
Collector ID: 3
  Agent-ID: 1.2.3.4
  Address: 30.1.1.1
  Instance: default
  Number of samples: 3
  Sampling-rate: 10
  UDP-Destination-Port: 6344
Collector ID: 4
  Agent-ID: 1.2.3.4
  Address: 40.1.1.1
  Instance: default
  Number of samples: 2
  Sampling-rate: 10
  UDP-Destination-Port: 6344
    
```

### Example 2: Summary Output for a specified sFlow collector

```

supervisor@rtbrick: op> show traffic-sampling sflow collector 1
Collector ID: 1
  Agent-ID: 1.2.3.4
  Address: 10.1.1.1
  Instance: default
  Number of samples: 5
  Sampling-rate: 10
  UDP-Destination-Port: 6343
    
```

## Sampling Profiles

Displays the packet sampling profile related information.

Syntax:

**show traffic-sampling profile** <options>

Option	Description
<profile-name>	Name of the profile.

### Example 1: Summary Output for traffic sampling profiles

```

supervisor@rtbrick: op> show traffic-sampling sflow profile
Profile name: test
  Collector Id: 1
  Direction: ingress
Profile name: test1
    
```

```
Collector Id: 2  
Direction: ingress
```

## Example 2: Summary Output for traffic sampling for a specified profile

```
supervisor@rtbrick: op> show traffic-sampling sflow profile test  
Profile name: test  
Collector Id: 1  
Direction: ingress
```

# 16. Telemetry

## 16.1. TSDB

### 16.1.1. Prometheus Time Series Database (TSDB) Integration Overview

Operational-state visibility is key for troubleshooting, testing, monitoring and capacity management. This requires to sample router metrics periodically. Ingestion of time-series data allows to ask of interesting operational queries.

Examples:

- A slightly increasing memory consumption over time while the overall PPPoE session count has not changed, for example, is an indication of a memory leak.
- If the 5-minute chassis temperature is too high, this might be an indication for an imminent hardware breakdown and the switch hardware must be replaced.
- If utilization of all fabric interfaces is constantly touching the 80% saturation levels then new fabric links must be commissioned.
- High input traffic with degradation of optical receive levels might be an indication of running very close to the optical budget.

The challenge is to sample all this information efficiently in terms of disk, memory and CPU utilization while providing comprehensive query and reporting functionality.

### Supported Platforms

Not all features are necessarily supported on each hardware platform. Refer to the *Platform Guide* for the features and the sub-features that are or are not supported by each platform.

### Architectural Overview

The RBFS telemetry architecture is based on Prometheus as an open-source systems monitoring and alerting toolkit. Prometheus is designed to pull metrics periodically and save them efficiently. It allows us to analyze the metrics with a powerful query language called **PromQL**. Also, an optional alert management is

available. There is an opportunity to tie it together with its own services to integrate it into the system landscape. Data should have short retention times (default 15d).

This fits perfectly with the needs of BDS. The figure below shows how it fits in an overall architecture.

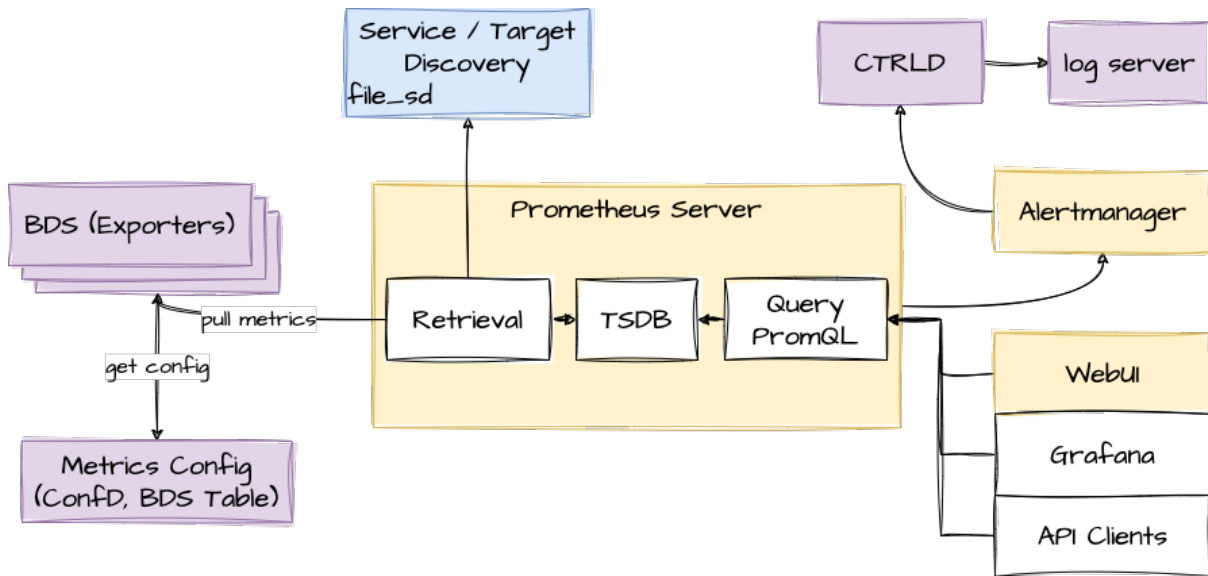

Figure 28. Prometheus in RBFS

To mitigate the short retention times, which fits to BDS but not in an overall telemetry process, the data can be stored in a centralized storage database (for example, Influx) this can be done by federation or via remote storage adapters. To distribute the alert messages from Prometheus, CTRLD functions as an "alertmanager webhook receiver", which takes the alert and distributes it to a log management tool.

### Router deployment model

Prometheus DB is run on the router as a dedicated process. It ships with a package-time configuration to poll each BDS-capable speaker at periodic intervals. Initially the periodic interval is 1 second. The **Prometheus Exposition format** is a very simple HTTP-based GET query that asks a given BD speaker "Give me all your metrics". Each BD subscribes to the *global.time-series.metric.config* table, which contains an operator-configurable list of BDS targets. Only the BDS which is the master of a table responds. Next Prometheus polls the BD using the */metrics* URL.

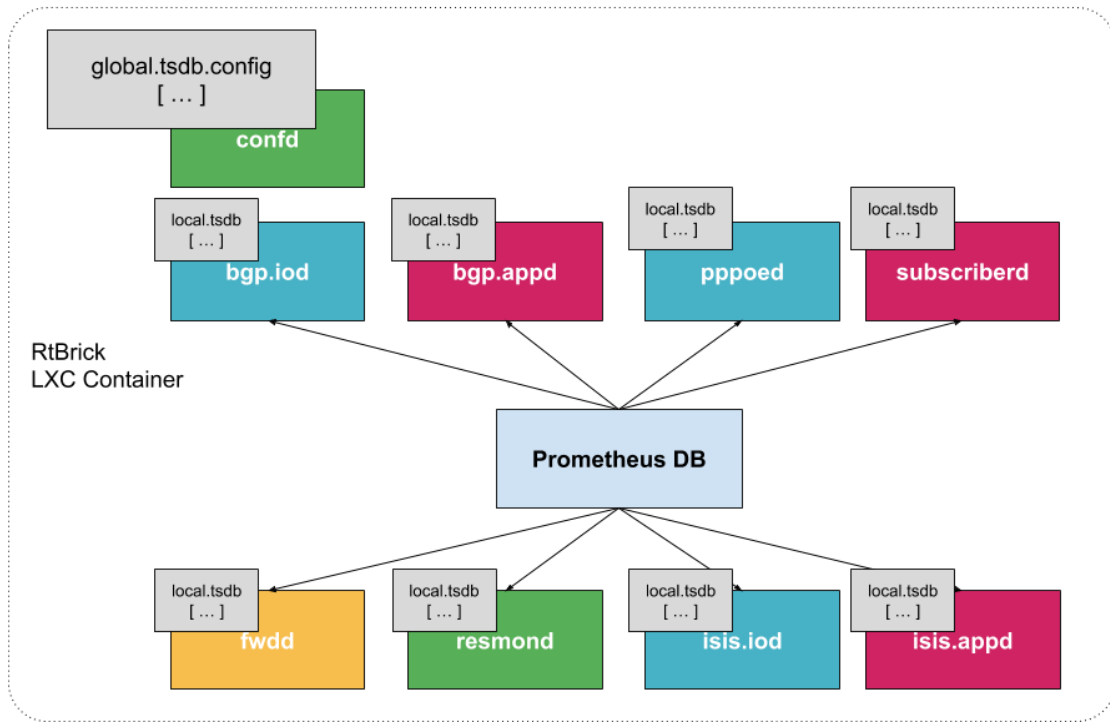

Figure 29. Prometheus in RBFS with the different scrape target

### Storage efficiency

On average Prometheus uses only around 1-2 bytes per sample. Thus, to plan the capacity of a Prometheus server, you can use the rough formula:

```
needed_disk_space = retention_time_seconds * ingested_samples_per_second * bytes_per_sample
```

The single binaries disk space:

```
-rwxr-xr-x 1 root root 27M Sep 2 22:51 alertmanager +
-rwxr-xr-x 1 root root 81M Sep 2 22:51 prometheus +
-rwxr-xr-x 1 root root 49M Sep 3 19:55 promtool
```

Promtool is needed to test the configurations before set them to prometheus.

### Alerting

The alerting is configured through Prometheus. For more information, see [alertmanager](#).

### Role of CTRLD

Prometheus and Alertmanager register themselves in CTRLD, so that CTRLD is

aware of these two services.

Refer to [Figure-1](#), which provides an overview of the role of CTRLD.

## Service state and Proxy

The registration of the services gives 2 advantages:

1. The operational state is an indicator that the service is up and running.
2. The proxy functionality of CTRLD can be used for Prometheus and alertmanager.

The proxy functionality is used for querying Prometheus directly:

```
curl
'http://198.51.100.125:19091/api/v1/rbfs/elements/rtbrick/services/prometheus/proxy/api/v1/query?query=up' | jq .
```

But it is also used for federation and therefore the following URL is used:

```
http://198.51.100.125:19091/api/v1/rbfs/elements/rtbrick/services/prometheus/proxy/federate
```

## Alert distribution

CTRLD can forward the alerts from the alertmanager to Graylog or any other REST endpoint.

## API for Configuration

CTRLD provides a REST API Endpoint for the configuration of alerts and metrics.

## Federation deployment model



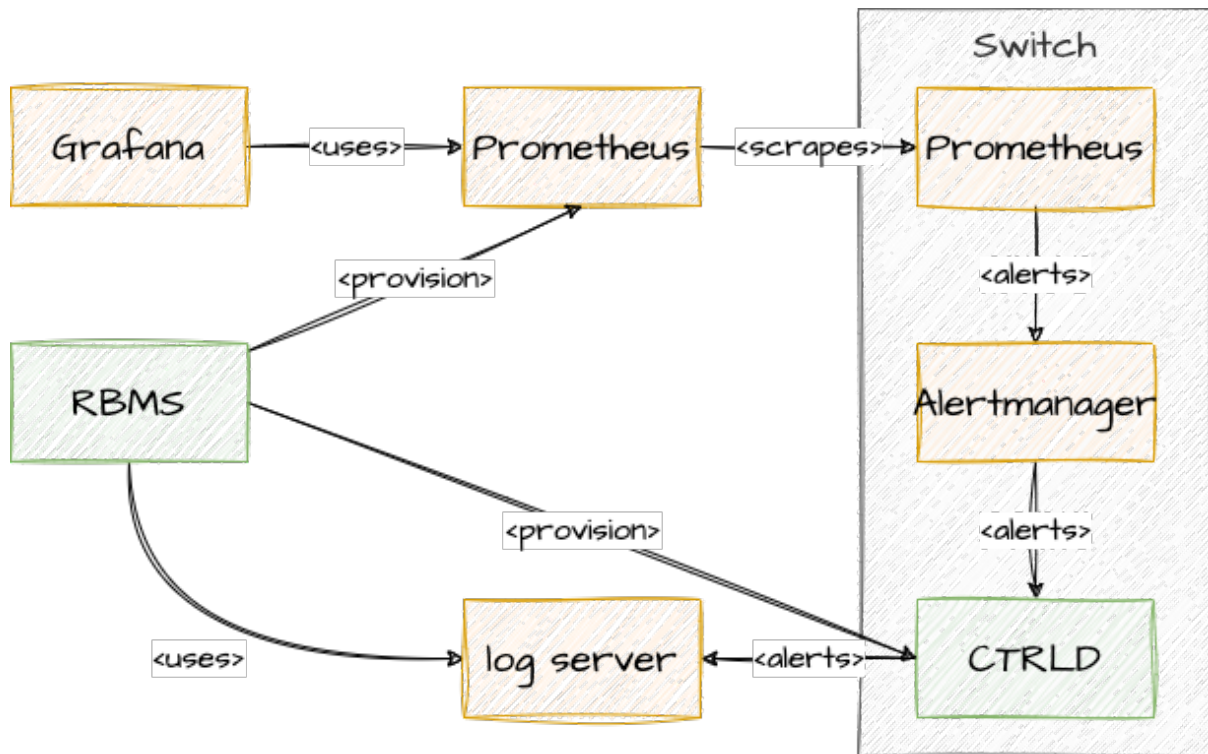

Figure 30. Federation of Prometheus, Alertmanager and graylog target

Prometheus is intended to have at least one instance per datacenter usually; also with a global Prometheus for global graphing or alerting. Federation allows for pulling metrics and aggregations up the hierarchy.

In the global Prometheus config, this time-series is pulled:

prometheus.yml:

```

global:
  scrape_interval: 60s # By default, scrape targets every 15 seconds.
  # A scrape configuration containing exactly one endpoint to scrape:
  scrape_configs:
    - job_name: "federate"

    honor_labels: true
    metrics_path: '/federate'
    params:
      'match[]':
        - '{job="bds"}'
    scrape_interval: 15s
    # Patterns for files from which target groups are extracted.
    file_sd_configs:
      - files:
          - ./bds.target.yml
        refresh_interval: 5m
    
```

The match[] here requests all BDS job time series. By following this job naming convention, you do not have to adjust the config whenever there is a new

aggregating rule.

The targets itself can be configured in a separate file.

bds.target.yml:

```
- targets: ['198.51.100.125:19091']
  labels:
    __metrics_path__:
      "/api/v1/rbfs/elements/rtbrick/services/prometheus/proxy/federate"
    box: 125_rtbrick
```

## 16.1.2. TSDB Configuration

The following section describes how to configure the system to gather metrics and alerts out of the system.

### Metric

To better understand the Data Model have a look at the [Prometheus Data Model](#).

### Metric Data Model

In RBFS it is possible to turn each table attribute into a metric.



When you export the time-series metric data for an attribute which has more than 50 label values (user-defined, default labels), you may see truncated data in the exported metric.

The following table describes the configuration model:

Metric	
metric_name	Name of the metric ( <a href="#">metric name conventions</a> ). That is the unique identifier for the metric.
table_name	Table Name for which the metric is designed, could also be a regular expression.
append_timestamp	Timestamp is epoch rendered in milliseconds and its value is equal to current metrics value's creation time in RBFS.

bds_metric_type	<ul style="list-style-type: none"> <li>• object-metric: if the metric should be gathered from regular table attributes</li> <li>• index-metric: if the metric should be gathered out of an attribute of an index table</li> </ul>
index_name	Name of the index, if the bds_metric_type is index-metric.
metric_type	<ul style="list-style-type: none"> <li>• gauge: is a metric that represents a single numerical value that can arbitrarily go up and down. Gauges are typically used for measured values like temperatures or current memory usage, but also "counts" that can go up and down, like the number of concurrent requests.</li> <li>• counter: is a cumulative metric that represents a single monotonically increasing counter whose value can only increase or be reset to zero on restart. For example, you can use a counter to represent the number of requests served, tasks completed, or errors. Do not use a counter to expose a value that can decrease. For example, do not use a counter for the number of currently running processes; instead use a gauge.</li> </ul>
metric_description	Description of the metric.
attributes	List of Attributes (see Attribute Table) that will be streamed as metric.
filters	List of AttributeFilters (see AttributeFilter Table) that filters the table rows which should be considered for metric generation. Each filter in this list has to match in order to generate the metric, so the list implies an implicit AND.

### Attribute

attribute_name	<p>Name of the attribute that should be streamed as metric.</p> <p>This Attribute has to be a numeric type, or a type that has a numeric converter.</p>
----------------	---

filters	List of AttributeFilters (see the <a href="#">[tsdb:tsdb_config::AttributeFilter]</a> table) that filters the table rows which should be considered for metric generation. Each filter in this list has to match in order to generate the metric, so the list implies an implicit AND.
labels	List of AttributeLabels (see the <a href="#">[tsdb:tsdb_config::AttributeLabel]</a> table) that are attached to that metric.

<b>AttributeFilter</b>	
match_attribute_name	Attribute of the Table which is used to match against.
match_type	<ul style="list-style-type: none"> <li>• exact: so the attribute has to match exactly the match value</li> <li>• regular-expression: the match value is a regular expression the attribute must match</li> </ul>
match_value	The value that attribute has to match against.

<b>AttributeLabel</b>	
<p><b>CAUTION:</b> Remember that every unique combination of key-value label pairs represents a new time series, which can dramatically increase the amount of data stored. Do not use labels to store dimensions with high cardinality (many different label values), such as user IDs, email addresses, or other unbounded sets of values.</p>	
label_name	Name of the Label ( <a href="#">label name conventions</a> ).
dynamic	bool: If the label is dynamic, the label_value is treated as attribute_name, so the value of the attribute is used as the label value, otherwise the label value is used directly.
label_value	The value of the label or the attribute which should be used as label value.

filters	List of AttributeFilters (see <a href="#">[tsdb:tsdb_config::AttributeFilter]</a> Table) that filters the table rows which should be considered for label generation. Each filter in this list has to match in order to generate the label, so the list implies an implicit AND.
---------	--

## Configuring Metrics

The configuration of the Metrics can be done in various ways.

### Configuring Metrics using Command Line Interface

To configure the Time Series Database, perform the following steps:

1. Define Metric configuration
2. Define Attribute configuration
3. Optional Filters at Metric Level and Attribute level
4. Defining labels to be attached to exported metric

### Metric Configuration

Metric configuration is used to configure the parameters of the metric data being exported.



Depending on the platform the exact resource name to be monitored can be found in `global.chassis_0.resource.sensor`, and adjust the Prometheus/Grafana configuration accordingly.

## Syntax

```
set time-series metric <name>
```

```
set time-series metric <name> description <128 character description about the metric-name>
```

```
set time-series metric <name> prometheus-type <counter / gauge>
```

```
set time-series metric <name> bds-type <object-metric / index-metric>
```

```

set time-series metric <name> table-name <table-name>

set time-series metric <name> attribute <attribute-name>

set time-series metric <name> index-name <index-name>

set time-series metric <name> append-timestamp <true>

set time-series metric <name> filter <match-attribute-name>

set time-series metric <name> include-subscribed-tables [true / false]>
    
```

## Command arguments

<metric-name>	Specifies the name of the metric exported, as would be reflected in Prometheus. Use the naming conventions as recommended by Prometheus
<128 character description about the metric-name >	Description of the metric
<counter / gauge>	Configures the metric data type. Currently the supported Prometheus metric data are: counter and gauge
<object-metric / index-metric >	Specifies the type of attribute, that is scraped and exported. There are two types, object-metric and index-metric
<table-name>	Specifies the target table, from which the data is scraped and exported.
<attribute-name>	Specifies the name of the attribute, in the target table to be scraped and exported
<append-timestamp>	Set the append-timestamp to true for exporting the metric values with timestamp. By default, the value is 'false'.
<index-name>	Specifies the index-name of the index-metric attribute. This configuration is applicable for index-metric alone.

<match-attribute-name>	Specifies the matching attribute name for the filter
include-subscribed-tables [true / false]	Specifies whether the configuration needs to be applied on a subscribed tables as well. Default: false.

## Example

```

admin@rtbrick: cfg> set time-series metric chassis_fan_speed_rpm
admin@rtbrick: cfg> set time-series metric chassis_fan_speed_rpm table-name
global.chassis_0.resource.sensor
admin@rtbrick: cfg> set time-series metric chassis_fan_speed_rpm bds-type object-
metric
admin@rtbrick: cfg> set time-series metric chassis_fan_speed_rpm prometheus-type
gauge
admin@rtbrick: cfg> set time-series metric chassis_fan_speed_rpm description
"Chassis fan speed in rpm"
admin@rtbrick: cfg> set time-series metric chassis_fan_speed_rpm attribute rpm
admin@rtbrick: cfg> set time-series metric chassis_fan_speed_rpm include-
subscribed-table false
    
```

## Allowed Attribute Types (Type Converters)

Normally only attributes are allowed, which are of type numeric, but for some types, there are built-in type converters, which allow also to use attributes of their types.

For the following BDS types, built-in type converters are provided by BDS. As per [Prometheus data model](#), type converter will convert the BDS type into a 64bit float number.

BDS data type	Outcome number represents
unix-wallclock-timestamp	Seconds
unix-usec-wallclock-timestamp	Seconds
unix-usec-monotonic-timestamp	Seconds
unix-usec-coarse-wallclock-timestamp	Seconds
bandwidth	bps(bit per second)
temperature	Degree Celsius

## Metric Filter Configuration

Metric filter configuration is used to configure the parameters of the filter. It is used to filter the exported metric. This is an optional configuration.

### Syntax

```
set time-series metric <name> filter <match-attribute-name>
```

```
set time-series metric <name> filter <match-attribute-name> match-type  
<exact / regular-expression>
```

```
set time-series metric <name> filter <match-attribute-name> match-  
attribute-value <match-attribute-value>
```

### Command arguments

<match-attribute-name>	Specifies the filter that filters the exported metric, based on specified criteria. This is optional configuration.
< exact / regular-expression >	Specifies the match type to be used, There are two options, exact and regular-expression.
<match-attribute-value>	Specifies the attribute value used for match.  Fixed value for exact.  Regex pattern for regular-expression

### Example

#### Exact Value

```
admin@rtbrick: cfg> set time-series metric chassis_fan_speed_rpm filter  
resource_type match-attribute-value fan  
admin@rtbrick: cfg> set time-series metric chassis_fan_speed_rpm filter  
resource_type match-type exact
```

#### Regular Expression



```
admin@rtbrick: cfg> set time-series metric chassis_fan_speed_rpm filter
resource_name match-attribute-value Chassis.*
admin@rtbrick: cfg> set time-series metric chassis_fan_speed_rpm filter
resource_name match-type regular-expression
```

## Metric Attribute Label Configuration

Metric attribute config is used to configure the labels to be attached to the exported metric.

## Syntax

```
set time-series metric <name> attribute <attribute-name> label <label-name>
```

```
set time-series metric <name> attribute <attribute-name> label <label-name> label-type <dynamic / static>
```

```
set time-series metric <name> attribute <attribute-name> label <label-name> label-value <label-value>
```

## Command arguments

<label-name>	Specifies the name of label. User definable, Please use naming conventions as recommended by Prometheus
<dynamic / static>	Specifies the type of labels, a static value or dynamic value to be added.
<label-value>	Specifies the label-value to be used.

## Example

### Dynamic Label

```
admin@rtbrick: cfg> set time-series metric chassis_fan_speed_rpm attribute rpm
label fan
admin@rtbrick: cfg> set time-series metric chassis_fan_speed_rpm attribute rpm
label fan label-value resource_name
admin@rtbrick: cfg> set time-series metric chassis_fan_speed_rpm attribute rpm
```

```
label fan label-type dynamic
```

## Static Label

```
admin@rtbrick: cfg> set time-series metric chassis_fan_speed_rpm attribute rpm
label vender
admin@rtbrick: cfg> set time-series metric chassis_fan_speed_rpm attribute rpm
label fan label-value rtbrick
admin@rtbrick: cfg> set time-series metric chassis_fan_speed_rpm attribute rpm
label fan label-type static
```

## Metric Attribute Filter Configuration

Attribute filter config is used to configure the parameters of Attribute filter. It is used to filter the exported metric based on certain fields of the attribute. This is an optional configuration.

## Syntax

```
set time-series metric <name> attribute <attribute-name> filter <match-attribute-name>
```

```
set time-series metric <name> attribute <attribute-name> filter <match-attribute-name> match-type <exact/regular-expression>
```

```
set time-series metric <name> attribute <attribute-name> filter <match-attribute-name> match-value <match-attribute-value>
```

## Command arguments

<attribute name>	Specifies the filter that filters the exported metric , based on criteria of the attribute. This is optional config.
<exact / regular-expression>	Specifies the match type to be used, There are two options, exact and regular-expression.
<match-attribute-value>	Specifies the attribute value used for match. Fixed value for exact. Regex pattern for regular-expression

## Example

The below example shows, the metric attribute will be exported only if the port\_stat\_if\_in\_discards is exactly 0.

```
admin@rtbrick: cfg> set time-series metric interface_statistics_data attribute
port_stat_if_in_ucast_pkts filter port_stat_if_in_discards
admin@rtbrick: cfg> set time-series metric interface_statistics_data attribute
port_stat_if_in_ucast_pkts filter port_stat_if_in_discards match-type exact
admin@rtbrick: cfg> set time-series metric interface_statistics_data attribute
port_stat_if_in_ucast_pkts filter port_stat_if_in_discards match-attribute-value 0
```

## Metric Label Filter Configuration

Label filter configuration is used to set filter parameters that can be used to attach label based on certain criteria. This is an optional configuration.

## Syntax

```
set time-series metric <name> attribute <attribute-name> label <label-
key> filter <match-attribute-name>
```

```
set time-series metric <name> attribute <attribute-name> label <label-
key> filter <match-attribute-name> match-type <regular-expression/exact>
```

```
set time-series metric <name> attribute <attribute-name> label <label-
key> filter <match-attribute-name> match-attribute-value <match-
attribute-value>
```

## Command arguments

<match-attribute-name>	Specifies the filter that filters the exported metric, based on some attribute value. This is optional config.
< exact / regular-expression >	Specifies the match type to be used, There are two options, exact and regular-expression.
<match-attribute-value>	Specifies the attribute value used for match. Fixed value for exact. Regex pattern for regular-expression

## Example

The below example sets label, interface\_orientation to the exported data, only if the interface\_name matches ifp-0/0/50.

```
admin@rtbrick: cfg> set time-series metric interface_statistics_data attribute
port_stat_if_in_ucast_pkts label interface_orientation
admin@rtbrick: cfg> set time-series metric interface_statistics_data attribute
port_stat_if_in_ucast_pkts label interface_orientation filter interface_name
admin@rtbrick: cfg> set time-series metric interface_statistics_data attribute
port_stat_if_in_ucast_pkts label interface_orientation filter interface_name
match-type exact
admin@rtbrick: cfg> set time-series metric interface_statistics_data attribute
port_stat_if_in_ucast_pkts label interface_orientation filter interface_name
match-attribute-value ifp-0/0/50
```

## Alert

RBFS uses the [prometheus alerting](#) feature to generate alerts. These alerts are forwarded to an alertmanager instance inside the rbfs container. The alertmanager instance sends the alert to CTRLD which distributes the alert to an HTTP Endpoint.

Alerts are also configured in a BDS table, and they are exported to Prometheus by the system.

### Alert Data Model

Alert	
name	The name of the alert rule. That is the unique identifier for the rule.
group	Name of the alert group the alert belongs to. The alert group helps to structure the alerts.

interval	<p>How often the rule should be evaluated.</p> <p>Pattern:"[0-9]+(ms  [smhdwy])"</p> <p>Example:"5s"</p> <p>In Prometheus the the interval can specified per alert group. So the alert alert group for Prometheus is calculated via {alert_group}_{interval}.</p>
expr	Alert evaluation expression in promql
labels	<p>Key, Value pairs of labels that should be applied. The labels clause allows specifying a set of additional labels to be attached to the alert. Any existing conflicting labels will be overwritten. The label values can be templated (see templating).</p>
annotations	<p>Key, Value pairs of annotations that should be applied. The annotations clause specifies a set of informational labels that can be used to store longer additional information such as alert descriptions or runbook links. The annotation values can be templated (see templating)</p>
for	<p>Alerts are considered firing once they have been returned for this long. Alerts which have not yet fired for long enough are considered pending.</p> <p>Pattern:"[0-9]+(ms  [smhdwy])"</p> <p>Example:"30s"</p>
level	<p>This is an explicit annotation label with the label name level. This is used to specify the severity:</p> <p>1.Alert</p> <p>The annotation value can be templated (see templating)</p>
summary	<p>This is an explicit annotation label with the label name summary. The annotation values can be templated (see templating).</p>

description	This is an explicit annotation label with the label name description. The annotation values can be templated (see templating).
-------------	--

## Configuration

The configuration of the Metrics can be done in various ways.

### Configuring Alert Using CLI

## Syntax

```

set time-series alert <name>
set time-series alert <name> group <group>
set time-series alert <name> for <for>
set time-series alert <name> interval <interval>
set time-series alert <name> expr <expr>
set time-series alert <name> level <level>
set time-series alert <name> summary <summary>
set time-series alert <name> description <description>
set time-series alert <name> labels <label>
set time-series alert <name> annotations <annotations>
    
```

## Command arguments

<name>	<b>The name of the alert rule. That is the unique identifier for the rule.</b>
<group>	Name of the alert group the alert belongs to. The alert group helps to structure the alerts.

<b>&lt;name&gt;</b>	<b>The name of the alert rule. That is the unique identifier for the rule.</b>
<interval>	<p>How often the rule should be evaluated.</p> <p>Pattern:"[0-9]+(ms  [smhdwy])"</p> <p>Example:"5s"</p> <p>In Prometheus the the interval can specified per alert group. So the alert alert group for Prometheus is calculated via {alert_group}_{interval}.</p>
<expr>	Alert evaluation expression in promql
<label>	Key, Value pairs of labels that should be applied. The labels clause allows specifying a set of additional labels to be attached to the alert. Any existing conflicting labels will be overwritten. The label values can be templated (see templating).
<annotations>	Key, Value pairs of annotations that should be applied. The annotations clause specifies a set of informational labels that can be used to store longer additional information such as alert descriptions or runbook links. The annotation values can be templated (see templating)
<for>	<p>Alerts are considered firing once they have been returned for this long. Alerts which have not yet fired for long enough are considered pending.</p> <p>Pattern:"[0-9]+(ms  [smhdwy])"</p> <p>Example:"30s"</p>
<level>	<p>This is an explicit annotation label with the label name level. This is used to specify the severity:</p> <p>1.Alert</p> <p>The annotation value can be templated (see templating)</p>

<b>&lt;name&gt;</b>	<b>The name of the alert rule. That is the unique identifier for the rule.</b>
<b>&lt;summary&gt;</b>	This is an explicit annotation label with the label name summary. The annotation values can be templated (see templating).
<b>&lt;description&gt;</b>	This is an explicit annotation label with the label name description. The annotation values can be templated (see templating).

## Example

```

admin@rtbrick: cfg> set time-series alert sample_alert
admin@rtbrick: cfg> set time-series alert sample_alert group hardware_metrics
admin@rtbrick: cfg> set time-series alert sample_alert for 30s
admin@rtbrick: cfg> set time-series alert sample_alert interval 5s
admin@rtbrick: cfg> set time-series alert sample_alert expr
avg_over_time(cpu_temperature_celcius[1m])>100
admin@rtbrick: cfg> set time-series alert sample_alert level 2
admin@rtbrick: cfg> set time-series alert sample_alert summary "Element {{
$labels.element_name }} CPU {{ $labels.cpu }} HIGH temperature"
admin@rtbrick: cfg> set time-series alert sample_alert description "Cpu {{
$labels.cpu }} of element {{ $labels.element_name }} has a temperature o
ver 100 for more than 30 seconds"
admin@rtbrick: cfg> set time-series alert sample_alert labels device:leaf1
admin@rtbrick: cfg> set time-series alert sample_alert annotations "sample-
annotation-key:sample-value"
    
```

## Enabling/Disabling Time Series Database History

In every Brick Daemon, the history of time series databases can be enabled. By default, time series database history is disabled.

### Syntax

**set time-series history-status** <option>

Attribute	Description
[disable   enable]	Enable or disable time series database history. Time series database history is disabled, by default.

Example:

```

supervisor@S2-STD-7-7006>bm06-tst.fsn.rtbrick.net: cfg> show datastore confd table
global.time-series.config
    
```



```
Object: 0, Sequence 3, Last update: Mon May 23 09:02:28 GMT +0000 2022
```

Attribute	Type	Length
Value		
configuration_name (1)	string (9)	8
rtbrick		
time-series-history-enable (2)	boolean (6)	1
False		

## Graylog Alert Distribution

The alertmanager on RBFS is configured to send alerts to CTRLD.

**ctrlld/elements/alerts** ▼

---

POST /api/v1/ctrlld/{element\_name}/alerts/heartbeats Prometheus alertmanager endpoint for Heartbeats

POST /api/v1/ctrlld/{element\_name}/alerts/log Prometheus alertmanager endpoint for logging the alerts to graylog

CTRLD therefore has an endpoint where the alerts are sent to. CTRLD translates the notification and forwards the message to the configured log management system. The instance used for forwarding is "prometheus".

### 16.1.3. Installation

The RtBrick fullstack comes with a ready to use tsdb instance. So no more installation on RBFS has to be done.

For federation of metrics, a global prometheus instance is needed. To visualize the metrics a Grafana instance has to be installed, and to get the alert messages, a graylog instance has to be set up. This document does not contain an installation guide for that systems.

The information about configuring a federation Prometheus to scrape metrics from a RBFS installation is described in the [\[tsdb:tsdb\\_installation:::federation\\_deployment\\_model\]](#) section.

## 16.2. Resmon

### 16.2.1. Resource Monitoring (resmon) Overview

Monitoring the system resources is very crucial to analyze the health of devices. RBFS has a dedicated daemon called **resmond** to discover and monitor the device resources. Resmond polls the system resources to gather the status of the

resource and store this data in the resource-specific BDS table.

The Resource Monitoring (resmon) functionality of RBFS provides support for monitoring the following components:

- CPU
- Memory
- Processes
- Disks
- Sensor
- Optics

## CPU

Resmond collects CPU hardware information from the [global.chassis\\_0.resource.cpu](#) table. In addition, Resmond calculates CPU usage dynamically and stores this information in the [global.chassis\\_0.resource.cpu\\_usage](#) table.

## Memory

Resmond collects RAM hardware information from the [global.chassis\\_0.resource.mem](#) table. In addition, Resmond gathers memory usage information in the [global.chassis\\_0.resource.mem\\_usage](#) table.

## Processes

Resmond collects process usage information of Brick Daemon(BD) that runs in the RBFS and stores the information in the [global.chassis\\_0.resource.proc\\_usage](#) table. It dynamically gathers the process information and calculates the CPU and the memory usage of the individual Brick Daemons.

## Disks

Resmond collects the disk information from the [global.chassis\\_0.resource.disk](#) table. In addition, Resmond collects disk usage information in the [global.chassis\\_0.resource.disk\\_usage](#) table.

## Sensor

Resmond collects the reading data of the hardware sensor such as temperature, fan, power-supply, and system LED. The data collected from the sensor are stored in the `global.chassis_0.resource.sensor` table.



The RBFS implementation supports pluggable optics modules on white box switches only.

## System Clock

Resmond provides support for monitoring the system clock so that the system clock is always in sync with the NTP server clock. This ensures that the deviation from the NTP server clock always remains within acceptable limits. Resmond collects the system clock information from the `global.os.timex` table.



The RBFS implementation supports pluggable optics modules on white box switches only.

## Optical Modules

Resmond monitors optical transceivers plugged onto the chassis. It reads transceivers EEPROM (Electrically Erasable Programmable Read-Only Memory) data and translates the data to respective fields in the BDS tables.

Resmond provides the following functionalities for monitoring optical transceivers:

- Provides a mechanism to discover and monitor optics modules. Supported optics modules include SFP, SFP+, QSFP, QSFP+, and QSFP28 (DAC is not supported).
- Provides CLIs to write to optics modules
- Provides show commands to see optics inventory and status of each module
- Logs the status of the optics module



The RBFS implementation supports monitoring of pluggable optics modules on white box switches only.

The following are some of the important tasks (but not limited to) that the Resmond application performs:

- Optics inventory: Identifying the following brief information of a discovered optics module and stores in table [global.chassis\\_0.resource.optics.inventory](#).

Port

Type

Vendor

Serial Number

Part Number

- Read the following optics data from a module and stores in the table: [global.chassis\\_0.resource.optics.module](#).

RX/TX alarming (loss of light and loss of signal)

- RX/TX power status

Voltage and BIAS status

Temperature

- Write the optics data to an optics module

Enabling high power class on QSFP28

Shutdown lasers (QSFP28, SFP+ and SFP)

## Optics Logging

The **Resmond** can log the following Optics module events:

- Temperature high alarm
- Temperature high warning
- Temperature low alarm
- Temperature low warning
- Voltage high alarm
- Voltage high warning
- Voltage low alarm
- Voltage low warning
- Lane power high alarm
- Lane power high warning

- Lane power low alarm
- Lane power low warning
- Lane bias high alarm
- Lane bias high warning
- Lane bias low alarm
- Lane bias low warning

## Q2C Resource Monitoring

Q2C platform resource-specific usage metrics are stored in the BDS table: [local.bcm.q2c.resource.monitor](#). Resource usage information enables you to understand the scale of services that the device performs and how it optimally leverages the resource usage.

The following table provides the list of supported resource types for monitoring in RBFS for Q2C platforms.

Resource Type	Description
EEDB_L2TP	EEDB is an Egress Encapsulation Data Base. This resource is consumed when L2TP subscribers are created in hardware.
EEDB_MPLS_TUNNEL	EEDB is an Egress Encapsulation Data Base. This resource is consumed when MPLS tunnels are created in the chip.
EEDB_PPPOE	EEDB_PPPOE is used for PPPoE encapsulation. This resource is consumed when PPPoE subscribers are created in hardware.
EEDB_PWE	This resource is consumed when L2X or cross-connection sessions are created in hardware at egress.
IN_LIF_FORMAT_PWE	This resource is consumed when a pseudowire is created in the hardware at ingress.
IN_AC_C_C_VLAN_DB	This resource is consumed when an ingress logical interface for double-tagged VLAN is created.

Resource Type	Description
IN_AC_C_VLAN_DB	This resource is consumed when an ingress logical interface for single tag VLAN is created.
IN_AC_UNTAGGED_DB	This resource is consumed when an ingress logical interface for untagged IFLs is created.
IPV4_MULTICAST_PRIVATE_LPM_FORWARD	LPM stands for Longest Prefix Match. This resource is consumed for multicast (source, group) entries.
IPV4_UNICAST_PRIVATE_LPM_FORWARD	This resource is consumed for non-default VRF instance IPv4 prefixes.
IPV4_UNICAST_PRIVATE_LPM_FORWARD_2	This resource is consumed for default VRF instance IPv4 prefixes.
IPV6_UNICAST_PRIVATE_LPM_FORWARD	This resource is consumed for non-default VRF instance IPv6 prefixes.
IPV6_UNICAST_PRIVATE_LPM_FORWARD_2	This resource is consumed for default VRF instance IPv6 prefixes.
L3_RIF	This resource is consumed for the L3 interfaces.
L2TPV2_DATA_MESSAGE_TABLE	This resource is consumed when the L2TP subscribers are created in hardware.
MPLS_FWD	This resource is consumed for MPLS entries for which forwarding actions are involved.
MPLS_TERMINATION_SINGLE_LABEL_DB	This resource is consumed for MPLS entries for which label termination is required.
MULTICAST_MCDB	This resource is consumed for multicast groups created in hardware.
PPPOE_O_ETH_TUNNEL_FAMILY_SA	This resource is consumed for PPPoE subscribers in hardware.

Example: Logical table information for the resource type EEDB\_L2TP

```

supervisor@rtbrick: dbg> bcm "dbal table info table=EEDB_L2TP"

Logical table info  EEDB_L2TP
=====

Access method: MDB
Table type: DIRECT
Touched status: Initialized
Entries Status: Max Capacity: HW dependent (see mapping), Committed 0
    
```

```

Bulk mode range NOT supported
Maturity_level: HIGH
Table Labels: L2, L3, MPLS, EEDB
Core mode: SBC
Max key value: 1048575
Max payload size in bits: 101
<...>

```

Example: Logical table information for the resource type EEDB\_MPLS\_TUNNEL

```

supervisor@rtbrick: dbg> bcm "dbal table info table=EEDB_MPLS_TUNNEL"

Logical table info  EEDB_MPLS_TUNNEL
=====

Access method: MDB
Table type: DIRECT
Touched status: Initialized
Entries Status: Max Capacity: HW dependent (see mapping), Committed 18
Bulk mode range NOT supported
Maturity_level: HIGH
Table Labels: L2, L3, MPLS, EEDB
Core mode: SBC
Max key value: 1048575
Max payload size in bits: 147
<...>

```

## QAX Resource Monitoring

QAX platform resource-specific usage metrics are stored in the BDS table: [local.bcm.qax.resource.monitor](#). Resource usage information enables you to understand the scale of services that the device performs and how it optimally leverages the resource usage.

The following table provides the list of supported resource types for monitoring in QAX platforms.

Resource Type	Description
ECMP ID	It represents an index in the table that maintains the paths for a particular ECMP route.
Egress Failover ID	It identifies failover paths for traffic leaving the device.
FEC Failover ID	This is used to manage failover paths for FECs.
FECs for Global Use	It represents the number of FECs that are available for general use across the device.

<b>Resource Type</b>	<b>Description</b>
Field Direct Extraction Entry ID	It represents the entries in the FDE table, which are used for direct extraction of fields.
Field Entry ID	It identifies a specific entry used for field-based operations.
Ingress Failover ID	It identifies backup paths for traffic entering the device.
Local Common InLif	It represents the number of common InLifs (Ingress Logical Interface) allocated for incoming traffic.
Local OutLif	It represents the number of logical interfaces allocated for outgoing traffic.
Local Wide InLif	Wide InLifs are used for additional metadata or special handling is required for incoming traffic. It represents the number of wide InLifs allocated for such purposes.
Number of Meters in Processor A	Meters are used for rate limiting or policing traffic, ensuring that traffic adheres to predefined bandwidth limits. This represents the number of meters available and used in processor A.
Profiles for PON Use	Profiles related to Passive Optical Networks are used in the management and configuration of PON interfaces. The number of profiles allocated for PON operations.
QOS EGRESS DSCP/EXP MARKING PROFILE IDs	These IDs represent the QoS marking profiles used to mark outgoing traffic based on DSCP or EXP bits, ensuring the prioritization of outgoing traffic.
QOS EGRESS L2 I TAG PROFILE IDs	These IDs are used for profiles that manage Layer 2 (L2) tagging in egress traffic. The number of available profiles for L2 I Tagging.
QOS EGRESS MPLS PHP QOS IDs	The IDs identify QoS profiles used for MPLS PHP (Penultimate Hop Popping) operations.
QOS EGRESS REMARK QOS IDs	This is used to re-mark packets with a new QoS value as they exit the device. IDs represent the QoS profiles that apply new markings to egress traffic.



<b>Resource Type</b>	<b>Description</b>
QOS INGRESS COS OPCODE IDs	COS (Class of Service) opcodes are used to classify incoming traffic based on criteria such as type of service. The IDs represent different COS opcode profiles for classifying ingress traffic.
QOS INGRESS LABEL MAP ID	Maps are used to associate incoming packets with certain labels for QoS processing. The number of available Label Maps for ingress traffic.
QOS INGRESS LIF/COS IDs	This ID is used for associating incoming traffic with specific LIF (Logical Interface) and COS profiles for handling. The number of IDs available for mapping ingress traffic to LIF/COS profiles.
QOS INGRESS PCP PROFILE IDs	Priority Code Point (PCP) profiles are used to prioritize packets at the ingress based on their PCP value. The IDs represent available PCP profiles for prioritizing ingress traffic.
SW Handles of Policer	It represents the number of software handles available for configuring policers.
Trill Virtual Nickname	It represents the number of virtual nicknames allocated for TRILL protocol operations for creating loop-free multi-path Ethernet network.
VLAN Translation Egress Usage	The number of entries used for VLAN translation operations on out-going traffic.
VLAN Translation Ingress Usage	The number of entries used for VLAN translation on incoming traffic.
VSIs for MSTP	The number of VSIs (Virtual Switch Instances) allocated for MSTP operations.
VSIs for TB VLANS	The number of VSIs allocated for handling TB VLANS.

## Supported Platforms

Not all features are necessarily supported on each hardware platform. Refer to the *Platform Guide* for the features and the sub-features that are or are not supported by each platform.

## 16.2.2. Resmon Configuration

### Configuration Hierarchy

The diagram illustrates the Resmon configuration hierarchy.

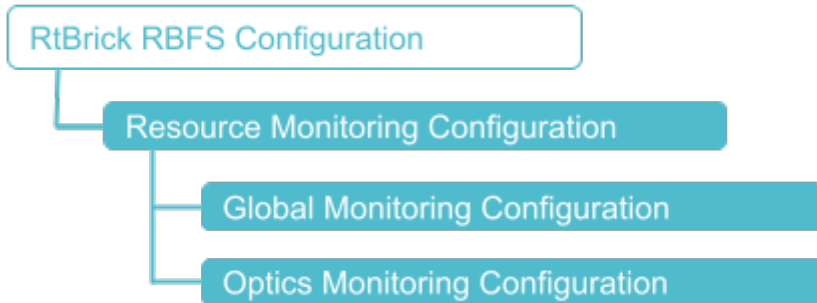

### Configuration Syntax and Commands

The following sections describe the Resmon configuration syntax and commands.

#### Global Monitoring Configuration

This command sets the poll-interval for the resmond to discover optics.

#### Syntax:

**set resmon monitoring** <poll-interval>

Attribute	Description
poll_interval <poll-interval>	Specifies the interval (in seconds) at which optics should be polled. The interval can range from 3 to 10000 seconds. The default interval is 10 seconds.

#### Optics Configuration

You can use this command to disable or enable (By, default enabled) tx laser or high-power class of an optics module on a specific interface.

#### Syntax:

**set resmon optics** <interface> ...

Attribute	Description
interface <interface-name>	Name of the interface
high-power-class [disable / enable]	Enable or disable high power class for optics module. Enabled, by default.
tx [disable / enable]	Enable or disable lasers for optics module. Enabled, by default.

### 16.2.3. Resmon Operational Commands

#### Resmon Show Commands

The Resmon show commands provide detailed information about the resources and their usage.

#### CPU Information

This command displays the CPU detail and CPU information.

#### Syntax:

**show cpu** <option>

Option	Description
summary	Displays the CPU information.
usage	Displays the CPU usage information

#### Example 1: CPU summary

```

supervisor@rtbrick: op> show cpu summary
CPU_0
  Vendor           : GenuineIntel
  Model            : Intel(R) Xeon(R) CPU D-1518 @ 2.20GHz
  Architecture     : x86_64
  Serial No       : 63 06 05 00 FF FB EB BF
  Clock(MHz)      : 1996.620
  BogomIPS        : 4400.00
  Physical cores   : 4
  Logical cores    : 8
  Endian          : True
  Cache alignment  : 64 Bytes
  L1 data cache    : 32768 Bytes
  L1 instruction cache : 32768 Bytes
    
```

```

L2 unified cache      : 262144 Bytes
L3 unified cache      : 6291456 Bytes
L4 unified cache      : 0 Bytes
supervisor@rtbrick: op>
    
```

Example 2: CPU usage information.

```

supervisor@rtbrick: op> show cpu usage
Name      Total      User      System      Nice      I/O Wait      Idle      IRQ      Soft  IRQ
cpu       31%       23%       8%          0%        0%            68%      0%      0%    0%
cpu0     11%       4%        5%          0%        0%            88%      0%      2%    0%
cpu1    100%     63%      36%         0%        0%            0%       0%      0%    0%
cpu2     54%     51%       2%          0%        0%            45%      0%      0%    0%
cpu3     57%     55%       2%          0%        0%            42%      0%      0%    0%
cpu4      6%       1%        5%          0%        0%            93%      0%      0%    0%
cpu5      4%       2%        2%          0%        0%            95%      0%      0%    0%
cpu6      8%       3%        4%          0%        0%            91%      0%      0%    0%
cpu7      6%       1%        5%          0%        0%            94%      0%      0%    0%
supervisor@rtbrick: op>
    
```

## Memory Details

This command displays the memory details and usage information.

**Syntax:**

**show memory** <option>

Option	Description
summary	Displays the system memory information.
usage	Displays the memory usage information.

Example 1: System memory information

```

supervisor@rtbrick: op> show memory summary
System Memory
  Maximum capacity      : 128 GB
  Error correction type  : Multi-bit ECC
  Number of memory slots available : 4
  Number of memory slots occupied  : 2
Bank      Size      Location      Type      Speed      Configured Speed  Vendor      Serial
No      Part No
NODE 1    8192 MB    DIMM_A1      DDR4      2133 MT/s    2133 MT/s        Undefined    00000002
TS1GSH72V1H
NODE 1    8192 MB    DIMM_B1      DDR4      2133 MT/s    2133 MT/s        Undefined    00000027
TS1GSH72V1H
    
```

Example 2: System memory usage information.

```

supervisor@rtbrick: op> show memory usage
Name      Total      Used      Free      Shared      Buffers      Cached
    
```

RAM	16.69 GB	4.54 GB	10.08 GB	578.17 MB	103.12 MB	2.06 GB
SWAP	0 bytes	0 bytes	0 bytes	n/a	n/a	n/a

## Process Details

This command displays the process usage information.

### Syntax:

**show process usage** <option>

Option	Description
process-id <pid>	Displays the process usage for the specified process identifier.
process-name <process-name>	Displays the process usage for the specified process.
summary	Displays the process usage summary information.

Example 1: Process usage summary information.

```

supervisor@rtbrick: op> show process usage summary
Name          PID      VIRT      Resident Memory    Sharable Memory    CPU Percentage
Memory Percentage  CPU Affinity
bgp.appd.1    4456     384.67 MB  122.69 MB          29.32 MB           0.81
0.74          0-7
bgp.iod.1     4469     694.63 MB  148.39 MB          30.22 MB           2.01
0.89          0-7
confd         213      1.24 GB   769.9 MB           31.89 MB           0.81
4.61          0-7
etcd          110      600.9 MB  196.4 MB           29.26 MB           1.21
1.18          0-7
fibd          288      13.68 GB  1.74 GB            210.79 MB          161.17
10.45         1
ifmd          147      496.74 MB  154.25 MB          29.99 MB           1.01
0.92          0-7
igmp.appd.1   4482     356.38 MB  100.29 MB          29.27 MB           1.01           0.6
0-7
igmp.iod.1    4495     540.14 MB  132.68 MB          29.41 MB           2.01           0.8
0-7
ipoed.1       175      503.51 MB  112.9 MB           29.3 MB            2.01
0.68          0-7
l2tpd.1       4508     475.71 MB  103.45 MB          29.26 MB           2.01
0.62          0-7
lldpd         128      368.32 MB  106.75 MB          29.29 MB           2.21
0.64          0-7
mribd         158      381.8 MB  115.57 MB          29.38 MB           1.01
0.69          0-7
    
```

Example 2: Process usage for the specified process.

```

supervisor@rtbrick: op> show process usage process-name fibd
Process Name: fibd
PID          : 288
    
```

```

REST port           : 5522
Debug port         : 5521
Allowed CPU list   : 1
CPU usage at user space : 25964
CPU usage at kernel space : 12633
CPU usage percentage : 152.815678
Memory usage percentage : 10.452729
Peak virtual memory usage : 13355692
Current virtual memory usage : 13.68 GB
<...>
    
```

**Example 3: Process usage for the specified process ID.**

```

supervisor@rtbrick: op> show process usage process-id 4456
Process Name: bgp.appd.1
  PID           : 4456
  REST port     : 4102
  Debug port    : 4101
  Allowed CPU list : 0-7
  CPU usage at user space : 20103
  CPU usage at kernel space : 18011
  CPU usage percentage : 1.011122
  Memory usage percentage : 0.735218
  Peak virtual memory usage : 375652
  Current virtual memory usage : 384.67 MB
  Locked virtual memory : n/a
  RSS virtual memory : 122.69 MB
<...>
    
```

**Sensor Details**

This command displays the fan, power-supply, system-led, and temperature information.

**Syntax:**

**show sensor** <option>

Option	Description
fan	Displays information about the sensor fan.
power-supply	Displays the sensor power supply information.
system-led	Displays system LED information
temperature	Displays the sensor temperature information.
detail	You can specify <b>detail</b> at the end of any of the options above to display information in detail.

### Example 1: Sensor temperature information.

```

supervisor@rtbrick: op> show sensor temperature
Name                Temperature        Status
CPU Core            54 °C             PRESENT
LM75-1-48           35 °C             PRESENT
LM75-2-49           30 °C             PRESENT
LM75-3-4A           33 °C             PRESENT
LM75-3-4B           30 °C             PRESENT
PSU-1 Thermal Sensor 1  31 °C             PRESENT
supervisor@rtbrick: op>

```

### Example 2: Detailed information about the sensor temperature.

```

supervisor@rtbrick: op> show sensor temperature
Name                Temperature        Status
CPU Core            54 °C             PRESENT
LM75-1-48           36 °C             PRESENT
LM75-2-49           30 °C             PRESENT
LM75-3-4A           33 °C             PRESENT
LM75-3-4B           30 °C             PRESENT
PSU-1 Thermal Sensor 1  31 °C             PRESENT
supervisor@rtbrick: op>

```

### Example 3: Information about sensor fan

```

supervisor@rtbrick: op> show sensor fan
Name                Fan Speed (rpm)    Status
PSU 1 - Fan 1      26496              PRESENT, F2B
Chassis Fan - 1    8700                PRESENT, F2B
Chassis Fan - 2    8700                PRESENT, F2B
Chassis Fan - 3    8700                PRESENT, F2B
Chassis Fan - 4    8700                PRESENT, F2B
Chassis Fan - 5    8700                PRESENT, F2B
Chassis Fan - 6    8600                PRESENT, F2B
supervisor@rtbrick: op>

```

### Example 4: Detailed information about sensor fan.

```

supervisor@rtbrick: op> show sensor fan detail

PSU 1 - Fan 1
  Sensor resource ID : 8388614
  Vendor              : n/a
  Model               : NULL
  Serial No           : n/a
  Status              : PRESENT, F2B
  Status code         : 9
  Fan speed           : 26496 rpm
  Location            : PSU 1
Chassis Fan - 1
  Sensor resource ID : 8388608

```

```

Vendor          : ALTERA
Model           : 5M1270ZF256C5N
Serial No      : n/a
Status         : PRESENT, F2B
Status code    : 9
Fan speed      : 8700 rpm
Location       : Fan Board
Chassis Fan - 2
Sensor resource ID : 8388609
Vendor         : ALTERA
Model          : 5M1270ZF256C5N
Serial No     : n/a
Status        : PRESENT, F2B
Status code   : 9
Fan speed     : 8800 rpm
Location      : Fan Board
    
```

### Example 5: Sensor power supply information

```

supervisor@rtbrick: op> show sensor power-supply
Name           Current In  Current Out Voltage In  Voltage Out Power In   Power Out  Status
PSU-1          0 mA       12109 mA   0 mV       11984 mV   0 mW      146000 mW PRESENT
PSU-2          0 mA       0 mA      0 mV       0 mV       0 mW      0 mW      PRESENT, UNPLUGGED
supervisor@rtbrick: op>
    
```

### Example 6: Detailed information about the sensor power supply.

```

supervisor@rtbrick: op> show sensor power-supply detail

PSU-1
  Sensor resource ID : 16777216
  Vendor             : n/a
  Model              : YM-2651Y
  Serial No         : n/a
  Status             : PRESENT
  Status code       : 1
  Input current      : 0 mA
  Output current     : 12031 mA
  Input voltage      : 0 mV
  Output voltage     : 11984 mV
  Input power        : 0 mW
  Output power       : 144000 mW
  Location           : n/a

PSU-2
  Sensor resource ID : 16777217
  Vendor             : n/a
  Model              : NULL
  Serial No         : n/a
  Status             : PRESENT, UNPLUGGED
  Status code       : 5
  Input current      : 0 mA
  Output current     : 0 mA
  Input voltage      : 0 mV
  Output voltage     : 0 mV
  Input power        : 0 mW
  Output power       : 0 mW
  Location           : n/a
    
```



```
supervisor@rtbrick: op>
```

## Example 7: Sensor system LED information

```
supervisor@rtbrick: op> show sensor system-led
Name                LED Mode          Status
Chassis LED 1 (LOC LED)  OFF              PRESENT
Chassis LED 5 (FAN LED)  AUTO             PRESENT, ON
Chassis LED 2 (DIAG LED) OFF              PRESENT
Chassis LED 3 (PSU1 LED) AUTO             PRESENT, ON
Chassis LED 4 (PSU2 LED) AUTO             PRESENT, ON
supervisor@rtbrick: op>
```

## Example 8: Detailed information about the system LED

```
supervisor@rtbrick: op> show sensor system-led detail

Chassis LED 1 (LOC LED)
  Sensor resource ID   : 12582912
  LED mode             : OFF
  Status               : PRESENT
  Status code          : 1
  Capability            : ON_OFF, ORANGE
  Capability code      : 4097
Chassis LED 5 (FAN LED)
  Sensor resource ID   : 12582916
  LED mode             : AUTO
  Status               : PRESENT, ON
  Status code          : 5
  Capability            : ON_OFF, AUTO
  Capability code      : 4194305
Chassis LED 2 (DIAG LED)
  Sensor resource ID   : 12582913
  LED mode             : OFF
  Status               : PRESENT
  Status code          : 1
  Capability            : ON_OFF, ORANGE, GREEN
  Capability code      : 69633
```

## Optics Details

This command displays optics information for inventory and interface.

### Syntax:

**show optics** <option>

Option	Description
interface <interface-name>	Displays optics information for the specified interface.
inventory	Displays optics inventory information.

Example: Optics information for the specified interface.

```

supervisor@rtbrick: op> show optics interface ifp-0/1/6
Physical Interface: ifp-0/1/6
Type : QSFP28
Description : 100G-CWDM4
Connector Type : Lucent Connector
Vendor : FS
Serial Number : F2030882972
Part Number : QSFP28-IR4-100G
Vendor Material Number : CMUIAMACAB10-3146-02
Power Class : Class 4 (3.5W)
Power Class State : HIGH
Wavelength : 1310.000000
Lane Id : 1
Laser bias current : 30.824 mA
Laser tx power : 1.496 mW / 1.749 dbm
Laser rx power : 1.084 mW / 0.35 dbm
Module temperature : 39.164 °C
Module voltage : 3.292 V
Tx disable : False
High power class enable : True
Laser Tx loss of signal : False
Laser Tx loss of lock : False
Laser Rx loss of signal : False
Laser Rx loss of lock : False
Laser bias current high alarm : False
Laser bias current high warning : False
Laser bias current low alarm : False
Laser bias current low warning : False
Module voltage high alarm : False
Module voltage high warning : False
<...>
    
```

Example 2: Optics inventory information.

```

supervisor@rtbrick: op> show optics inventory
Interface      Type      Description      Connector Type      Vendor      Part Number      Serial
Number  Material Number  Power Class      Power State
ifp-0/1/2      QSFP28    100GBASE-CR4    No Seperable connector  FS          Q28-PC005
G2110248549-1  n/a              Class 1 (1.5W)    LOW
ifp-0/1/3      QSFP28    100G-CWDM4      Lucent Connector      LambdaGain   LL1C31A2A      L12AA60027
T-UNIQSF40907038  Class 4 (3.5W)  HIGH
ifp-0/1/4      QSFP28    100GBASE-CR4    No Seperable connector  FS          Q28-PC01
G2006503747-2  n/a              Class 1 (1.5W)    LOW
ifp-0/1/5      QSFP28    100GBASE-LR4    Lucent Connector      LambdaGain   LL1S31B0A      L82A9S0018
T-UNIQSF40907039  Class 4 (3.5W)  HIGH
ifp-0/1/6      QSFP28    100G-CWDM4      Lucent Connector      FS          QSFP28-IR4-100G
F2030882972    CMUIAMACAB10-314  Class 4 (3.5W)  HIGH
ifp-0/1/8      QSFP28    100GBASE-CR4    No Seperable connector  FS          Q28-PC005
G2110248550-1  n/a              Class 1 (1.5W)    LOW
    
```

ifp-0/1/9	QSFP28	100GBASE-CR4	No Seperable connector	FS	Q28-PC005	
G2110248551-1	n/a		Class 1 (1.5W) LOW			
ifp-0/1/11	QSFP28	100GBASE-CR4	No Seperable connector	Fiberstore	QSFP28-100G-DAC	
F1800032252-2	n/a		Class 1 (1.5W) LOW			
ifp-0/1/14	QSFP28	100GBASE-CR4	No Seperable connector	FS	Q28-PC005	
G2110248569-1	n/a		Class 1 (1.5W) LOW			
ifp-0/1/15	QSFP28	100GBASE-CR4	No Seperable connector	FS	Q28-PC01	
G2006503745-1	n/a		Class 1 (1.5W) LOW			
ifp-0/1/18	QSFP28	100GBASE-CR4	No Seperable connector	FS	Q28-PC01	
G2006503743-1	n/a		Class 1 (1.5W) LOW			
ifp-0/1/20	QSFP28	100G-CWDM4	Lucent Connector	LambdaGain	LL1C31A2A	L12AB20043
T-UNIQSF40907038	Class 4 (3.5W)	HIGH				
ifp-0/1/27	QSFP28	100GBASE-LR4	Lucent Connector	LambdaGain	LL1S31B0A	L82A9S0025
T-UNIQSF40907039	Class 4 (3.5W)	HIGH				
ifp-0/1/28	QSFP28	100GBASE-CR4	No Seperable connector	FS	Q28-PC01	
G1810038309-1	n/a		Class 1 (1.5W) LOW			
ifp-0/1/31	QSFP28	100GBASE-CR4	No Seperable connector	FS	Q28-PC01	
G1810038285-2	n/a		Class 1 (1.5W) LOW			
ifp-0/0/0	SFP	UNKNOWN	Copper Pigtail	FS	SFPP-PC015	
S2108004616-2	n/a		Class 1 (1.5W) LOW			
ifp-0/0/1	SFP	UNKNOWN	Copper Pigtail	FS	SFPP-PC015	
G2006548415-2	n/a		Class 1 (1.5W) LOW			

## Disk Details

This command displays disk information.

### Syntax:

**show disk** <option>

Option	Description
summary	Displays the disk information.
usage	Displays the disk usage information.

Example: Summary of disks and their partitions.

```

supervisor@rtbrick: op> show disk summary
sda
  Size      : 29.8G
  Vendor    : ATA
  Model     : TS32ZBTMM1600
Partitions
Name        Size      Mountpoint
sda1       256M     n/a
sda2       128M     n/a
sda3        2G      n/a
sda4       128M     n/a
sda5       128M     n/a
sda6        2G      n/a
sda7       25.2G    /platform
supervisor@rtbrick: op>
    
```

Example 2: Summary of disk usage information.

```

supervisor@rtbrick: op> show disk usage
Filesystem      Type      Size      Used      Available  Mountpoint  Usage %
none            tmpfs     492 KB    0 bytes   492 KB    /dev        0.0
tmpfs           tmpfs     8.15 GB   17.38 MB  8.13 GB   /run        0.21
tmpfs           tmpfs     6.29 GB   483.6 MB  5.81 GB   /shm        7.69
tmpfs           tmpfs     8.15 GB   62.74 MB  8.09 GB   /dev/shm    0.77
tmpfs           tmpfs     5.12 MB   0 bytes   5.12 MB   /run/lock   0.0
devtmpfs       devtmpfs  1.02 MB   0 bytes   1.02 MB   /dev/mem    0.0
/dev/sda7      ext4      25.87 GB  4.47 GB   20.06 GB  /var/log    18.21
tmpfs           tmpfs     1.63 GB   0 bytes   1.63 GB   /run/user/1000 0.0
tmpfs           tmpfs     8.15 GB   0 bytes   8.15 GB   /sys/fs/cgroup 0.0
tmpfs           tmpfs     1.63 GB   696 KB    1.63 GB   /var/run-ext/onl/r 0.04
/var/cache/rtbrick/imag overlay    25.87 GB  4.47 GB   20.06 GB  /           18.21
supervisor@rtbrick: op>
    
```

## Platform Details

This command displays platform information.

### Syntax:

#### show platform

Example: Platform information

```

supervisor@rtbrick: op> show platform
x86_64-accton_as7316_26xb-r0
Vendor          : Edgecore
Manufacturer    : Accton
Manufacture date : 05/07/2021 16:55:51
MAC address     : 90:3c:b3:16:00:00
Part number     : F0PZZ5626002A-MACDDR-Nanya_NT5AD256M16D4_HRI
Serial number   : AAB2115AACA
Product name    : 7316-26XB-O-AC-F
Onie version    : 2019.11.00.07
Label revision  : R01C
Diag version    : 01.01.00.03
Country code    : TW
supervisor@rtbrick: op>
    
```

## Hardware Resource Usage Information

The command `show hardware resource monitor` displays the hardware consumption information for the various resources.

### Syntax:

#### show hardware resource monitor

Example: Hardware resource monitoring information

```

supervisor@rtbrick: op> show hardware resource monitor
Resource Type                               Consumed Estimated
EEDB_L2TP                                   0 49152
EEDB_MPLS_TUNNEL                            0 49152
EEDB_PPPOE                                   0 49152
EEDB_PWE                                     0 49152
IN_AC_C_C_VLAN_DB                           0 60292
IN_AC_C_VLAN_DB                             36 60292
IN_AC_UNTAGGED_DB                           3 60292
IPV4_MULTICAST_PRIVATE_LPM_FORWARD          0 568320
IPV4_UNICAST_PRIVATE_LPM_FORWARD           11 1136640
IPV4_UNICAST_PRIVATE_LPM_FORWARD_2         11 378880
IPV6_UNICAST_PRIVATE_LPM_FORWARD           7 568320
IPV6_UNICAST_PRIVATE_LPM_FORWARD_2         11 189440
KBP_IPV4_UNICAST_PRIVATE_LPM_FORWARD        0 0
KBP_IPV6_UNICAST_PRIVATE_LPM_FORWARD        0 0
L2TPV2_DATA_MESSAGE_TT                      0 60292
L3_RIF                                       51 40959
MPLS_FWD                                     0 1017112
MPLS_TERMINATION_SINGLE_LABEL_DB            14 60292
MULTICAST_MCDB                               2 262143
PPPOE_O_ETH_TUNNEL_FULL_SA                  0 24576

```

## 16.3. SNMP

### 16.3.1. SNMP Overview

SNMP (Simple Network Management Protocol) provides a network monitoring mechanism that collects state information from various network devices and components. The protocol enables you to monitor the RBFS network and detect network faults on remote devices.

SNMP can monitor interfaces, CPU usage, temperature of the device, bandwidth usage, and so on. For example, if an interface goes down on one of the devices, SNMP can quickly alert the change.

### Understanding RBFS SNMP Implementation

The RBFS SNMP implementation allows retrieving system state information using the Protocol Data Unit (PDU) from various network components. SNMP defines system objects in Management Information Bases (MIBs), where each object forms a Protocol Data Unit (PDU).

A device that is SNMP enabled is known as SNMP agent. SNMP agent collects information from various devices and components and stores the data within MIB. An SNMP agent includes several objects such as interfaces and routing tables

which can be interacted with. Every object has a unique identifier which is known as OID (Object Identifier). OIDs provide a unique identity for managed objects in an MIB hierarchy.

RBFS implements the SNMP daemon (`snmpd`) that maps the operational state API to SNMP MIBs for retrieving system state data.

## SNMP Operations

SNMP allows performing various operations that include GET for retrieving data, SET for modifying data, TRAP for notifying an event and so on. These operations provide management access to the MIB hierarchy.

1. **GET:** The SNMP GET operation retrieves data from the managed device's MIB.
2. **GETNEXT:** The GETNEXT operation retrieves data for the next object from the tree of objects on the device.
3. **SET:** The SNMP SET operation allows modifying data for a device.
4. **TRAP:** Event notification that is not requested.



RBFS does not currently support the SNMP SET operation.

## Supported SNMP MIBs

Management Information Base (MIB) is a collection of data that is organized hierarchically. You can define an MIB mapping for the supported MIBs. This MIB mapping provides a way to retrieve the required state information using the Operational State API or any other RBFS API or Prometheus.

Currently, RBFS supports two SNMP MIBs: the Interface MIB and the Host Resources MIBs.

**Host resource MIB:** Host resource MIB collects and provides information for host computer resources.

**Interfaces MIB:** Interfaces MIB retrieves information about the state of interfaces in devices.

**System MIB:** Collects and provides information about the device itself. The retrieved information includes the assigned system name, hardware platform details, and the installed network operating system software version.

## Supported SNMP Versions

RBFS supports the SNMP version 2c and SNMP version 3. SNMP version 3 provides support for authentication and encryption and the data can be accessed after capture only by authorized users. You must choose either version 2c or version 3 before configuring other functionalities.

### Information about SNMP v2c and v3

SNMP v2c allows access control through Communities, but the community information is not protected. Anyone with the community name can access all the information available for that community.

SNMP v3 provides a higher level of security using authentication and privacy protocols. RBFS supports the user-based security model defined in [RFC 3414](#).

The user credentials verify the authenticity and integrity of the message by adding message authentication codes (MACs) to the SNMP packet. The privacy protocol allows for the encryption of the transmitted data.

## Supported Platforms

Not all features are necessarily supported on each hardware platform. Refer to the *Platform Guide* for the features and the sub-features that are or are not supported by each platform.

### 16.3.2. SNMP Configuration

By default, SNMP is not enabled. To enable SNMP, you must complete the SNMP configurations.

RBFS supports SNMP 2c and 3 versions. You must first configure the desired version before configuring other functionalities. RBFS does not support running both the SNMP 2c and 3 versions at the same time.

The RBFS CLI displays all options regardless of the selected version. Even though functionalities such as Community can be configured for both of the versions, it works only in SNMP 2c version. You can define 'user profiles' on SNMP v3 and 'Community' in version 2c. Similarly, Engine ID can be defined in SNMP version 3.

## Configuration Hierarchy

The diagram illustrates the SNMP configuration hierarchy. All SNMP configurations are performed within an instance.

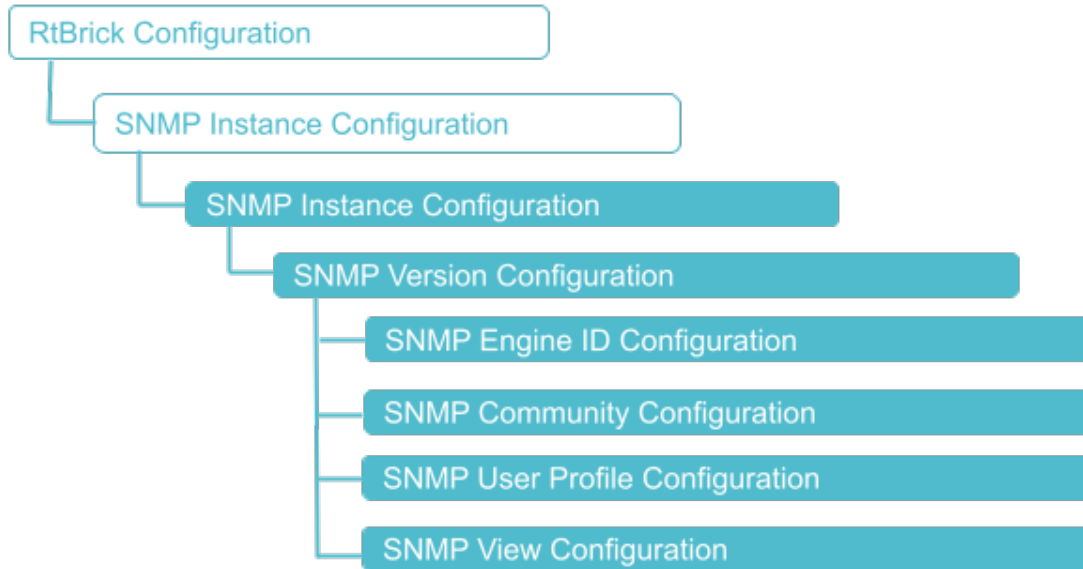

## Configuration Syntax and Commands

The following sections describe the SNMP configuration syntax and commands.

### SNMP Instance Configuration

At this instance configuration hierarchy, you configure SNMP protocol parameters which are generic to the SNMP instance.

### Syntax

**set instance** <instance-name> **protocol snmp** <attribute> <value>

Attribute	Description
version	Specify the SNMP version. RBFS supports SNMP version 2c and version 3. You must first configure the desired version before configuring other functionalities.



Attribute	Description
engine-id	<p>Specify the unique SNMP engine identifier. This is optional. If not specified, the system retrieves the default engine ID from the management port MAC address.</p> <p>Every SNMP v3 agent includes an engine ID that is a unique identifier for the agent. The engine ID is used to provide a higher level of security using authentication and encryption for SNMP v3 messages.</p>

### Example: SNMP Version and Engine Identifier Configuration

The following commands configure SNMP version 3 and engine ID: 268956.

```
set instance default protocol snmp version 3
set instance default protocol snmp engine-id 268956
```

The following example shows the SNMP version and engine ID configurations.

```
supervisor@rtbrick.net: cfg> show config instance default protocol snmp
{
  "rtbrick-config:snmp": {
    "version": "3",
    "engine-id": "268956"
  }
}
```

## SNMP Community Configuration

An SNMP community can be defined only in the SNMP version 2c.

### Syntax

**set instance** <instance-name> **protocol snmp community**

Attribute	Description
access-mode	Specify the access mode. Read, write and append are modes of access. 'ReadOnly' is the currently supported access mode.

Attribute	Description
view	Specify the list of view identifiers. View is optional. For information about Views, see section "2.2.3 SNMP View Configuration".

### Example: SNMP v2c Community Configuration

The following commands configure a Community named 'public' with read-only access right to the 'interfaces' View.

```
set instance default protocol snmp version 2c
set instance default protocol snmp community public access-mode ReadOnly
set instance default protocol snmp community public view Interfaces
```

The following example shows SNMP v2c community configurations.

```
supervisor@rtbrick: cfg> show config instance default protocol snmp
{
  "rtbrick-config:snmp": {
    "version": "2c",
    "community": [
      {
        "name": "public"
        "access-mode": "ReadOnly"
      }
    ]
  }
}
```

## SNMP View Configuration

An SNMP View is a subset of MIB objects. Views allow you to restrict access to certain items in the SNMP PDUs. You can restrict user and community access to certain attributes by defining views. A view restricts access to the PDUs included in the View. If the access is not restricted by views, the user or community is allowed to view all data available through SNMP.

## Syntax

**set instance** <instance-name> **protocol snmp** <attribute> <value>

Attribute	Description
include <include>	List of OID patterns that are included in the view.

Attribute	Description
instance	List of instances. It restricts the view to the specified instances. If no instance is defined, the view can access to all instances.

### Example: SNMP View Configuration

The following commands configure SNMP View. In this example configuration, SNMP version has been specified as 2c and 'View' name is specified as interfaces. The 'interfaces' view includes the OID 1.3.6.1.2.1.2.\* in the view list. In addition, the configuration shows a user 'community' named public has been configured and the community has read-only access to the View.

```
set instance default protocol snmp version 2c
set instance default protocol snmp view interfaces include 1.3.6.1.2.1.2.*
set instance default protocol snmp community public access-mode ReadOnly
```

The following example shows the SNMP View configuration.

```
supervisor@rtbrick: cfg> show config instance default protocol snmp
{
  "rtbrick-config:snmp": {
    "version": "2c",
    "view": [
      {
        "name": "interfaces",
        "include": [
          "1.3.6.1.2.1.2.*"
        ]
      }
    ],
    "community": [
      {
        "name": "public",
        "access-mode": "ReadOnly",
        "view": [
          "interfaces"
        ]
      }
    ]
  }
}
```

### SNMP Trap Configuration

The trap is a notification about a specific condition or event that occurs on the device. RBFS supports event notifications for events: link up and link down. Unlike

other PDU types, a trap is a notification that is sent without any request from the SNMP manager.

## Syntax

**set instance** <instance-name> **protocol snmp trap** <trap-name> <attribute> <value>

Attribute	Description
community	Community is supported in SNMPv2c only. Specify the 'Community' to enable trap notification for SNMPv2c.
include	List of OIDs that are included for the trap notifications.
instance	Specify the instance.
trap-receiver	Specify trap receiver device.
user-profile	User profile is supported on SNMPv3 only. Specify the 'user profile' to enable trap notification for SNMPv3.

## SNMP User Profile Configuration

You can create user profiles for SNMP version 3. It allows you to define login credentials, authentication methods, and privacy control.

## Syntax

**set instance** <instance-name> **protocol snmp user-profile**

Attribute	Description
authentication-protocol	Specify SNMP authentication protocol. MD5, NoAuth, SHA, SHA224, SHA256, SHA384, and SHA512 are the supported authentication protocol.
password-encrypted-text	Specify SNMP user password in encrypted text.
password-plain-text	Specify SNMP user password in plain text.
privacy-password-encrypted-text	Specify SNMP privacy password in encrypted text.

Attribute	Description
privacy-password-plain-text	Specify SNMP privacy password in plain text.
privacy-protocol	Specify SNMP privacy protocol. Supported privacy protocols include AES192, AES192C, AES256, AES256C, DES, and NoPriv.
security-level	Specify SNMP v3 security level. Security levels exist only in SNMP v3. The following security levels are supported: <ul style="list-style-type: none"> <li>• noAuthNoPriv: no authentication, no privacy</li> <li>• authNoPriv: authentication, no privacy</li> <li>• authPriv: authentication, privacy</li> </ul>
view	Specify SNMP view list.

### Example: SNMP User Profile Configuration

The following commands configure SNMP user profile. At first, SNMP Version 3 is configured with the user profile name as operator. Password type has been selected as password encrypted text. In this configuration, the security level is configured as **AuthNoPriv** and MD5 as type of the authentication protocol.

```
set instance default protocol snmp version 3
set instance default protocol snmp user-profile operator
set instance default protocol snmp user-profile operator password-encrypted-text
$2a6fd7db50a18a9f1f16b5c5b4214fab0
set instance default protocol snmp user-profile operator security-level AuthNoPriv
set instance default protocol snmp user-profile operator authentication-protocol
MD5
```

The following example shows the SNMP User Profile Configuration

```
supervisor@rtbrick: cfg> show config instance default protocol snmp
{
  "rtbrick-config:snmp": {
    "version": "3",
    "user-profile": [
      {
        "name": "operator",
        "password-encrypted-text": "$2a6fd7db50a18a9f1f16b5c5b4214fab0",
        "security-level": "AuthNoPriv",
        "authentication-protocol": "MD5"
      }
    ]
  }
}
```

```

    ]
  }
}

```

## Examples for SNMP Walk Operation

### SNMP v2c SNMP Walk Output

The following is a sample output for the SNMP Walk for SNMP version 2c. SNMP version 2c has been configured with Community name as 'public' and, host IP address as 10.200.134.25.

```

snmpwalk -v 2c -c public 10.200.134.25
iso.3.6.1.2.1.2.2.1.1.1 = INTEGER: 1
iso.3.6.1.2.1.2.2.1.1.2 = INTEGER: 2
iso.3.6.1.2.1.2.2.1.1.3 = INTEGER: 3
iso.3.6.1.2.1.2.2.1.1.4 = INTEGER: 4
iso.3.6.1.2.1.2.2.1.1.5 = INTEGER: 5
iso.3.6.1.2.1.2.2.1.1.6 = INTEGER: 6
iso.3.6.1.2.1.2.2.1.1.7 = INTEGER: 7
iso.3.6.1.2.1.2.2.1.1.8 = INTEGER: 8
iso.3.6.1.2.1.2.2.1.1.9 = INTEGER: 9
iso.3.6.1.2.1.2.2.1.1.10 = INTEGER: 10
iso.3.6.1.2.1.2.2.1.1.11 = INTEGER: 11
iso.3.6.1.2.1.2.2.1.1.12 = INTEGER: 12
iso.3.6.1.2.1.2.2.1.1.13 = INTEGER: 13
iso.3.6.1.2.1.2.2.1.1.14 = INTEGER: 14
iso.3.6.1.2.1.2.2.1.1.15 = INTEGER: 15
iso.3.6.1.2.1.2.2.1.1.16 = INTEGER: 16
iso.3.6.1.2.1.2.2.1.1.17 = INTEGER: 17
iso.3.6.1.2.1.2.2.1.1.18 = INTEGER: 18
iso.3.6.1.2.1.2.2.1.1.19 = INTEGER: 19
iso.3.6.1.2.1.2.2.1.1.20 = INTEGER: 20
iso.3.6.1.2.1.2.2.1.1.21 = INTEGER: 21
iso.3.6.1.2.1.2.2.1.1.22 = INTEGER: 22
iso.3.6.1.2.1.2.2.1.1.23 = INTEGER: 23
<...>

```

### SNMP v3 SNMP Walk Output

The following is a sample output for the SNMP Walk for SNMP version 3. SNMP version 3 has been configured with user as 'operator', MD5 as the authentication protocol, authNoPriv as the security level, and 10.200.134.25 as the host IP address.

```

snmpwalk -v 3 -u operator -A operator -a MD5 -l authNoPriv 10.200.134.25
iso.3.6.1.2.1.2.2.1.1.1 = INTEGER: 1
iso.3.6.1.2.1.2.2.1.1.2 = INTEGER: 2
iso.3.6.1.2.1.2.2.1.1.3 = INTEGER: 3
iso.3.6.1.2.1.2.2.1.1.4 = INTEGER: 4

```

```
iso.3.6.1.2.1.2.2.1.1.5 = INTEGER: 5
iso.3.6.1.2.1.2.2.1.1.6 = INTEGER: 6
iso.3.6.1.2.1.2.2.1.1.7 = INTEGER: 7
iso.3.6.1.2.1.2.2.1.1.8 = INTEGER: 8
iso.3.6.1.2.1.2.2.1.1.9 = INTEGER: 9
iso.3.6.1.2.1.2.2.1.1.10 = INTEGER: 10
iso.3.6.1.2.1.2.2.1.1.11 = INTEGER: 11
iso.3.6.1.2.1.2.2.1.1.12 = INTEGER: 12
iso.3.6.1.2.1.2.2.1.1.13 = INTEGER: 13
iso.3.6.1.2.1.2.2.1.1.14 = INTEGER: 14
iso.3.6.1.2.1.2.2.1.1.15 = INTEGER: 15
iso.3.6.1.2.1.2.2.1.1.16 = INTEGER: 16
iso.3.6.1.2.1.2.2.1.1.17 = INTEGER: 17
iso.3.6.1.2.1.2.2.1.1.18 = INTEGER: 18
iso.3.6.1.2.1.2.2.1.1.19 = INTEGER: 19
iso.3.6.1.2.1.2.2.1.1.20 = INTEGER: 20
iso.3.6.1.2.1.2.2.1.1.21 = INTEGER: 21
iso.3.6.1.2.1.2.2.1.1.22 = INTEGER: 22
iso.3.6.1.2.1.2.2.1.1.23 = INTEGER: 23
<...>
```

The following is a sample output for the SNMP System MIB walk operation.

```
snmpwalk -v 2c -c ufi17.q2c.u34.r6.nbg.rtbrick.net"
<...>
iso.3.6.1.2.1.1.1 = STRING: "UfiSpace S9600-102XC-R, RBFS 24.9.0-
g6daily.20241007154425+Bdevelopment.C8e6a3a56"
iso.3.6.1.2.1.1.2 = OID: iso.3.6.1.4.1.50058.1.1
iso.3.6.1.2.1.1.3 = Timeticks: (35079) 0:05:50.79
iso.3.6.1.2.1.1.4 = ""
iso.3.6.1.2.1.1.5 = STRING: "ufi17.q2c.u34.r6.nbg.rtbrick.net"
iso.3.6.1.2.1.1.6 = ""
iso.3.6.1.2.1.1.7 = INTEGER: 12
iso.3.6.1.2.1.1.7 = No more variables left in this MIB View (It is past the end
of the MIB tree)
<...>
```

# 17. Infrastructure

## 17.1. NTP

### 17.1.1. NTP Overview

Network Time Protocol (NTP) provides accurate time across a whole network of devices such as routers or switches and synchronizes time among these devices on a network. NTP uses an NTP server that maintains a highly accurate time. An NTP network is comprised of devices (clients) that are to be synchronized with the NTP server that has UTC time and provides it to the client devices.

#### Prerequisites

- Install and configure an NTP server on your network and remember the IP address of the NTP server.

#### Supported Platforms

Not all features are necessarily supported on each hardware platform. Refer to the *Platform Guide* for the features and the sub-features that are or are not supported by each platform.

### 17.1.2. NTP Configuration

#### Configuration Syntax and Commands

The following sections describe the NTP configuration syntax and commands.

#### Specifying the NTP Server

To configure the NTP server, you must specify details such as the IPv4 address and the domain name of the NTP server.

#### Syntax

```
set system ntp server <server-id> <option>
```



Attribute	Description
server <server-id>	Specifies the name of the NTP server.
ipv4-address <ipv4-address>	Specifies the IPv4 address of the NTP server.
domain-name <domain-name>	Specifies the domain name of the NTP server.
minpoll	Specifies the minimum interval between requests in seconds. NTP dynamically selects the optimal poll interval between the values specified for <b>minpoll</b> and <b>maxpoll</b> .
maxpoll	Specifies the maximum interval between requests in seconds. NTP dynamically selects the optimal poll interval between the values specified for <b>minpoll</b> and <b>maxpoll</b> .

Example:

```
{
  "ietf-restconf:data": {
    "rtbrick-config:system": {
      "ntp": {
        "server": [
          {
            "server-name": "NtpServerIPv4",
            "ipv4-address": "192.168.16.1",
            "minpoll": 3,
            "maxpoll": 17
          }
        ]
      }
    }
  }
}
```

## NTP Service Configuration

You can enable the NTP service under a specific VRF where NTP server is reachable (usually, the inband management VRF).

### Syntax:

**set inband-management instance <name> ntp**

Attribute	Description
<name> <instance-name>	Name of the instance
true/false	Enable or disable Network Time Protocol.

Example: NTP Configuration

```

{
  "rtbrick-config:inband-management": {
    "instance": [
      {
        "name": "mgmt-vrf",
        "ntp": "true"
      }
    ]
  }
}

```

## Setting the System Date & Time Using DHCP Option 42 NTP Servers Information

The RtBrick ONL installer image performs a boot time ntpdate operation to set the system date and time.

By default, it uses the pool.ntp.org but DHCP bindings received over the ma1 interface will override it if DHCP option 42 contains a list of one or more NTP servers.

Separately from this boot time setting, the system will continue to use NTPd to maintain accurate system date and time using the list of NTP servers contained in the RBFS configuration.

The [/etc/ntp.boot-time-servers.conf](#) file can be used to verify as its contents will be updated with the NTP servers from DHCP. Also, logs are available in [/var/log/rtbrick-boot-time-ntpdate.log](#).

### 17.1.3. NTP Operational Commands

#### OSPF Show Commands

##### NTP Status

Displays the NTP status information.

Syntax:

### show ntp status

Example: NTP Status

```
supervisor@rtbrick.net: op> show ntp status
Associd: 0 Status: 0615 leap_none, sync_ntp, 1 event, clock_sync,
Version: "ntpd 4.2.8p12@1.3728-o (1)", Processor: "x86_64",
System: "Linux/5.4.40-OpenNetworkLinux", Leap: 00, Stratum: 2,
Precision: -23, Rootdelay: 9.791, Rootdisp: 28.874, Refid: 193.203.3.171,
Reftime: eae063f2.d94d557e Thu, Nov 14 2024 11:56:34.848,
Clock: eae06777.af9fc4c5 Thu, Nov 14 2024 12:11:35.686, Peer: 64212,
Tc: 10, Mintc: 3, Offset: 0.039552, Frequency: -12.332, Sys_jitter: 0.195478,
Clk_jitter: 0.175, Clk_wander: 0.012, Tai: 37, Leapsec: 201701010000,
Expire: 202412280000
```

### NTP Associations

Displays the information about the various NTP servers configured.

Syntax:

### show ntp association <options>

Option	Description
no-resolve	Details without DNS resolution.

```
supervisor@rtbrick.net: op> show ntp association
Flags: * Synchronized, # Almost synchronized, + Selected for possible
synchronization,"
      - Candidate for selection, ~ Statically configured"
Remote           Refid           St T  When  Poll  Reach   Delay  Offset
Jitter
+194.50.19.117   131.188.3.222   2  u   522  1024   377    4.939   0.162
0.069
*193.203.3.171   .GPS.           1  u   897  1024   377    9.791   0.008
0.066
-51.75.67.47     157.13.205.54   3  u   770  1024   377    4.929  -0.110
0.149
+85.215.189.120  192.53.103.103  2  u   868  1024   377   13.483   0.043
0.181
-167.235.70.245  195.176.26.205  2  u   757  1024   377    0.883   0.158
0.332
-162.159.200.123 10.163.8.4      3  u   642  1024   377    4.160   0.439
0.484
```

## Verifying NTP Service on Linux

To get more information about NTP's status, use the `ntpq` command:

The command displays the NTP servers that the system is synchronized with.

```

supervisor@rtbrick>LEAF01:~ $ sudo ntpq -p
      remote           refid      st t when poll reach  delay  offset  jitter
=====
198.51.100.5        .XFAC.         16 u   -  64    0   0.000   0.000   0.000
    
```

## 17.2. Logging

### 17.2.1. Logging Overview

RBFS logging is the process of writing log messages during the execution of an event. RBFS logging provides you reports about the events in the entire RBFS ecosystem at different functional areas. Almost every component in an RBFS access network generates a varied form of log files. Therefore, there are many different types of logs. All these logs, which are generated from different components, can be exported to the log management server where you can view and analyze the real-time data. It provides you the ability to trace out the errors of the applications in real-time.

RBFS has been designed based on microservices architecture. An RBFS ecosystem contains multiple microservices and these microservices can be divided as Brick Daemons (BD) and other (non-BD) daemons. CtrlID and ApiGwD daemons are part of ONL, but they do not reside inside of RBFS container. BDS provides in-built infrastructure for logging which can be used by all BDS applications.

You can configure logging based on different severity levels available.

This document provides you information about logging in the entire RBFS ecosystem. It includes the RBFS container and the host OS which is ONL in case of hardware switches.

### Logging in RBFS Container

RBFS provides logging for the entire RBFS ecosystem that includes Brick Daemons (BD) and also for other (non-BD) daemons. Brick Daemons are built on top of BDS and other (non-BD) daemons (such as Prometheus) are the ones which are not

dependent on BDS.

The RBFS container logging infrastructure provides in-memory (BDS) and traditional (BD) logging support for RBFS applications. The BDS logging is a low-latency and in-memory logging which can be used in a high scale system without compromising much in performance whereas BD logging is a direct write to a file hence CPU-heavy.

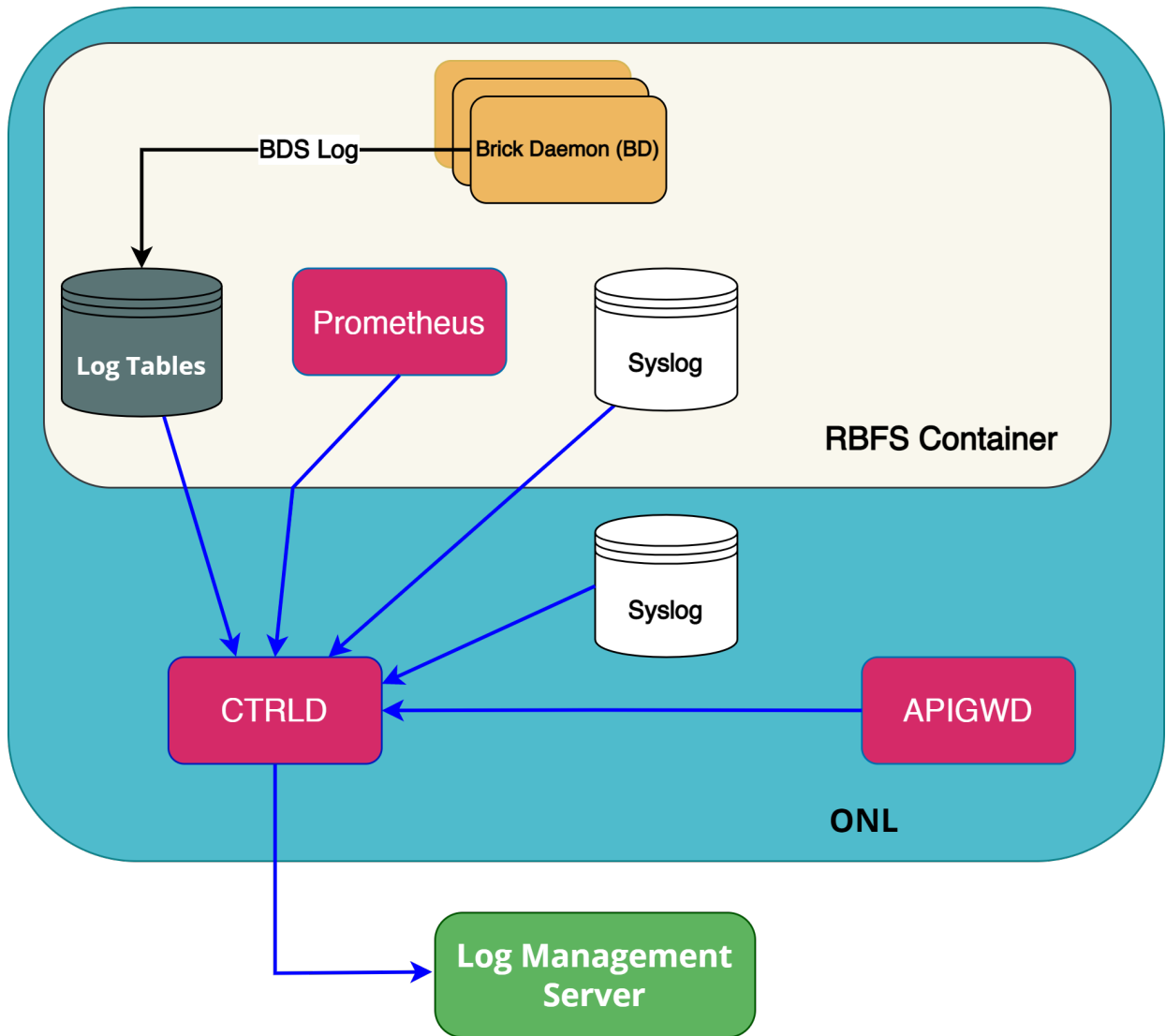

→ The blue arrow indicates logs exported to an external log server

In RBFS, logs are generated from various components or sources such as BDS, Syslog, CTRLD, APIGWd, and Prometheus. All these logs can be finally exported to a log management server.

## BDS Logging

BDS logs are stored in a log table. For every unique event, a log ID is created in RBFS. Whenever that particular event is logged, a log entry gets added to the log table. A log table is created for a module only when that module has at least one event logged. Every module in RBFS has at least one log table named in this format: `<modulename>.<bd-name>.log`.

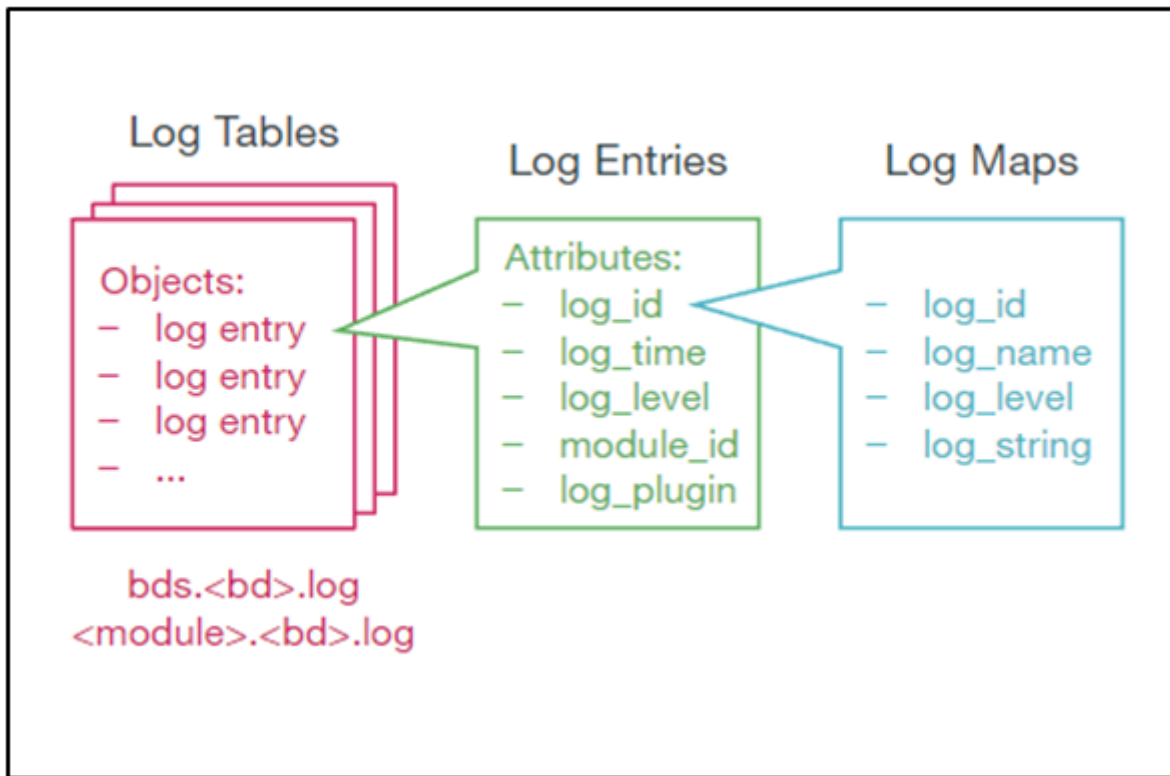

### Log Tables

BDS logs are stored in a BDS table. BDS creates a log table for each module in a BD. One entry is added to this log table for every log. Older entries are removed from the table when the number of entries exceeds more than 10,000.

### Log Maps

Every log is mapped to one specific event that is logged by the application. For the optimized usage of memory, RBFS does not store the verbose strings; instead, it stores the log map as an identifier to the actual string message.

**i** | Log map and log ID refer to the same entity.

You can access these log maps at the following location:

```
/usr/share/rtbrick/liblog/logs/
```

You can see the log maps, organized based on the modules that they belong to, at:

```
supervisor@rtbrick:/usr/share/rtbrick/liblog/logs$ ls
bds  bgp  fib  fwdinfra  ifm  lldpv2  pd  policy  pubsub  resmon  rib  snapshot
static  time_series
```

In the preceding example, you can see the modules that have registered with the log maps.

If you want to know more about a particular log map, you can perform a *grep* of the log map in this directory.

## Log Groups

A log group is a collection of log maps or log IDs. Groups have been introduced to simplify the log configuration tasks. For example, to debug a BGP peer issue, instead of enabling logs for individual log IDs that are related to BGP peer, you can enable log for a log group BGP peer.

## Log Modules

Every BDS application consists of multiple modules. Logging can be configured for each BDS modules separately.

The following are RBFS modules:

```
bcm_q2c
bgp
fib
hostconfd
ifm
igmp
ipoe
isis
l2tp
lag
ldp
license
lldp
mrib
ospf
pim
policy
poold
pppoe
```

```

resmon
rib
rtbrick-cli
secure_management
snapshot
subsMgmt
static
time_series
vpp
    
```

## Plugin Alias

Any logs in RBFS can be exported to an external logging destination. Currently, CtrID supports GELF and syslog as external plugins.

CtrlD is the egress node for all the GELF (Graylog Extended Log Format) messages. The brick daemons which are configured to send GELF messages to CtrlD and CtrlD forwards them to the configured endpoints such as syslog or GELF endpoint. This is because CtrlD enhances the GELF message with switch-global settings (for example, the serial number of the switch).

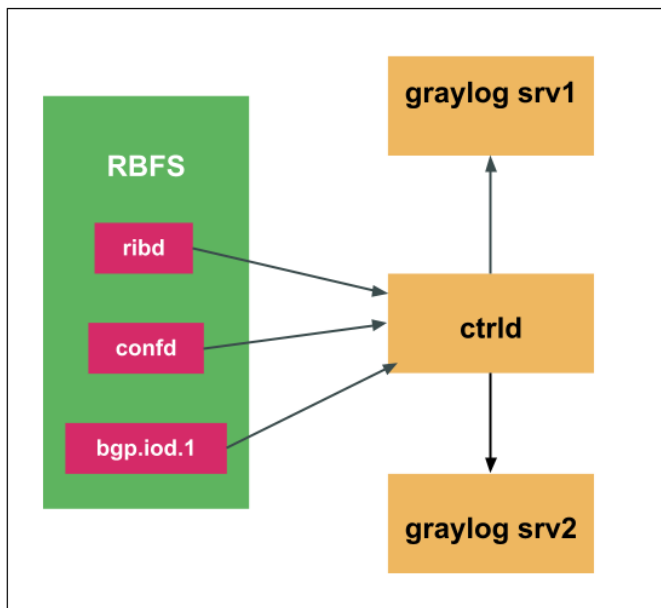

## Guidelines and Limitations for BDS Logging

- By default, BDS logging is enabled and the log level is set to 'Error'.
- By default, logging for BDS and PUBSUB modules have been disabled. As these two modules are infrastructure specific, these logs may not be useful for end-users. However, developers can enable logging for these modules using debug commands.



- You can configure log levels per BD, per module, or per group.
- Do not keep logging enabled for longer duration in a scaled setup.
- The following log levels are present in the system. Any level above the level **Warning** indicates that you should perform logging with caution as a scaled environment may cause a system instability.

Emergency

Alert

Critical

Error

Warning

Notice

Info

Debug

None



If your system becomes unstable, you can remove the logging configuration using the **delete log** command in configuration mode.



- All log levels lower than the log level specified are logged. For example, if the specified log level is "Warning", then all logs that come before "Warning" (Emergency, Alert, Critical, Error, Warning) are logged.
- When you set the log-level to "None", that means log has been disabled for the specific module, group, or global.

## Syslog

Syslog is generated by an API based logging mechanism provided by Linux. Some of the open source libraries present in RBFS use Syslog as a logging mechanism.

Host operating system and RBFS Linux container use syslog for logging. Syslog can also be exported to Graylog.

Syslog messages can also be exported to CtrlD and these messages are forwarded to the defined log management servers. Currently, RBFS supports exporting syslog

from the Linux and ONL system facilities such as `auth`, `authpriv`, `daemon`, and `kern` to Graylog

For information about Syslog configuration, see section [System Logging Configuration](#).

## TSDB (Prometheus) Alert Messages

Prometheus is the systems and service monitoring application, which can be deployed in RBFS, to collect and process metrics. In RBFS, alert messages generated from Prometheus are forwarded to CtrID and these messages, from CtrID, can be exported to the configured log management servers.

## Logging in ONL

In RBFS, there are daemons, which are not part of RBFS container, but run on the ONL host. RBFS provides logging for these daemons. The following are the daemons which reside on the ONL host:

```
hostconfd
CtrID
ApiGwD
```

## CtrlD and ApiGwD Logs

CtrlD logging provide log messages of events related to business, elements, ZTP, and security. ApiGwD logs contain details about who accessed the API and how they accessed it. `hostconfd` provides rest APIs to interact with container and ONL linux services.

`ApiGwD`and `CtrlD` send different log messages about status changes or progress of processes to the configured GELF endpoint.

## Supported Platforms

Not all features are necessarily supported on each hardware platform. Refer to the *Platform Guide* for the features and the sub-features that are or are not supported by each platform.

## 17.2.2. Logging Configuration

### Configuration Hierarchy

The diagram illustrates the logging configuration hierarchy.

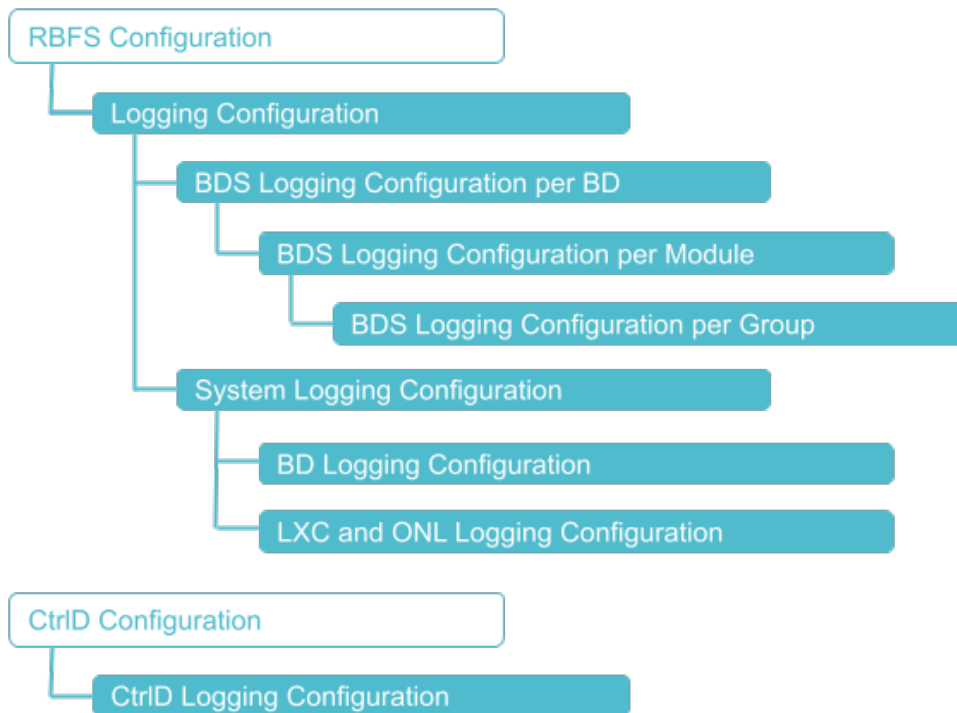

### Configuration Syntax and Commands

The following sections describe the logging configuration syntax and commands.

#### BDS Logging Configuration

You can configure BDS logging for a BD, a module, and for a group.



A specific configuration takes priority over a generic configuration. For example, if you have configured a global log level of `bgp.ioc.1` to "warning", and you have configured a log level of `bgp` module to "notice", then the final log level of `bgp` will be "notice".

#### Configuring BDS Logging for a BD

BDS logging can be configured for a BD.

**Syntax:**

**set log bd** <bd-name> <option> ...

Attribute	Description
<bd-name>	Configure for the specified BD name.
all	Configure for all BDs.
module <module-name>	Module name. For more information, see the section "Configuring BDS Logging for a Module".
plugin-alias alias-name <alias-name>	Plugin alias name
plugin-alias level <level>	<p>Log severity level. You can filter logs based on the log severity levels for sending to the external log management server. This will help you to send only the required log messages to the log management server instead of sending a whole lot of data.</p> <p>For example, if you configure <b>Warning</b> as the severity level, logs with the severity level 'Warning' and all the log levels above <b>Warning</b> such as <b>Error</b>, <b>Critical</b>, <b>Alert</b>, and <b>Emergency</b> will be sent to the log management server.</p>

**Example 1: BDS logging for a BD Configuration**

```
{
  "ietf-restconf:data": {
    "rtbrick-config:system": {},
    "rtbrick-config:log": {
      "bd": [
        {
          "bd-name": "bgp.iod.1",
          "level": "info",
          "plugin-alias": {
            "alias-name": "ztp",
            "level": "error"
          }
        }
      ]
    }
  }
}
```

## Configuring BDS Logging for a Module

Logging can be configured for a module such as BGP, IS-IS, and so on.

### Syntax:

**set log module** <module-name> <option> ...

Attribute	Description
<module-name>	Module name
group <group-name>	BDS log module log-group configuration. For more information, see the section "Configuring BDS Logging for a Group".
level <level>	Log severity level.
plugin-alias alias-name <alias-name>	Plugin alias name
plugin-alias level <level>	<p>Log level. You can filter logs based on the log severity levels for sending to the log management server. This will help you to send only the required log messages to the log management server instead of sending a whole lot of data.</p> <p>For example, if you configure <b>Warning</b> as the severity level, logs with the severity level 'Warning' and all the log levels above <b>Warning</b> such as <b>Error</b>, <b>Critical</b>, <b>Alert</b>, and <b>Emergency</b> will be sent to the log management server.</p>

### Example 1: Logging Module Configuration

```
{
  "ietf-restconf:data": {
    "rtbrick-config:system": {},
    "rtbrick-config:log": {
      "module": [
        {
          "module-name": "igmp",
          "level": "info",
          "plugin-alias": {
            "alias-name": "graylog-srv1",
            "level": "warning"
          }
        }
      ]
    }
  }
}
```

```

    ]
  }
}

```

### Configuring BDS Logging for a Group

Logging can be configured at the group hierarchy level.

**Syntax:**

**set log module** <module-name> **group** <group-name> <option> ...

Attribute	Description
<group-name>	Group name
level <level>	Specifies the level of the plug-in alias.
rate-limit <rate-limit>	Rate-limiting is only supported for log groups. Configuring a higher rate-limit for a whole module may cause system instability due to generation of high volume of logs. The default value is 10.
plugin-alias alias-name <alias-name>	Plugin alias name
plugin-alias level <level>	Specifies the level of the plug-in alias. You can filter logs based on the log severity levels for sending to the log management server. This will help you to send only the required log messages to the log management server instead of sending a whole lot of data.  For example, if you configure <b>Warning</b> as the severity level, logs with the severity level 'Warning' and all the log levels above <b>Warning</b> such as <b>Error</b> , <b>Critical</b> , <b>Alert</b> , and <b>Emergency</b> will be sent to the log management server.

### Example 1: Logging Group Configuration

```

{
  "ietf-restconf:data": {
    "rtbrick-config:log": {

```

```

"module": [
  {
    "module-name": "bgp",
    "group": [
      {
        "group-name": "interface",
        "level": "warning"
      }
    ]
  }
]
}

```

## System Logging Configuration

### LXC and ONL Logging Configuration

You can configure an external log management server to transport logs for real-time analysis. Currently, Syslog and Graylog are the log management servers supported by RBFS.

You can send logs from Linux and ONL system facilities such as **auth**, **authpriv**, **daemon**, and **kern** to the log management server.

#### Syntax:

**set log system facility** <facility-name> **plugin-alias** <attribute> <value>

Attribute	Description
<facility-name>	Supported facilities include <b>all</b> , <b>auth</b> , <b>authpriv</b> , <b>daemon</b> , and <b>kern</b> .
plugin-alias alias-name <alias-name>	Plugin alias name

Attribute	Description
plugin-alias level <level>	<p>Specify the level of the plug-in alias. You can filter logs based on the log severity levels for sending to the log management server. This will help you to send only the required log messages to the log management server instead of sending a whole lot of data.</p> <p>For example, if you configure <b>Warning</b> as the severity level, logs with the severity level 'Warning' and all the log levels above <b>Warning</b> such as <b>Error</b>, <b>Critical</b>, <b>Alert</b>, and <b>Emergency</b> will be sent to the log management server.</p>

### Example 1: System Log Configuration

```

{
  "ietf-restconf:data": {
    "rtbrick-config:log": {
      "system": {
        "facility": [
          {
            "facility-name": "kern",
            "plugin-alias": {
              "alias-name": "graylog",
              "level": "notice"
            }
          }
        ]
      }
    }
  }
}

```

### External Log Server (Plugin Alias) Configuration

You can configure an external log management server as a destination to transport logs.

#### Syntax:

**set system host log-alias** <attribute> <value>

Attribute	Description
<name>	Log alias name



Attribute	Description
<address>	Plugin address. For example, Gelf: <a href="http://11.1.1.1:1102/gelf">http://11.1.1.1:1102/gelf</a> Syslog: 10.1.1.1:8008
level	Severity level for the log.
network	Log alias endpoint port.
type	Server type of log alias.

### Example 1: Log alias Configuration

```

set system host log-alias bng endpoint http://10.1.1.1:1102/gelf
set system host log-alias bng endpoint http://10.1.1.1:1102/gelf type gelf
set system host log-alias bng endpoint http://10.1.1.1:1102/gelf network http
set system host log-alias bng endpoint http://10.1.1.1:1102/gelf level info
{
  "ietf-restconf:data": {
    "rtbrick-config:system": {
      "host": {
        "log-alias": [
          {
            "name": "bng",
            "endpoint": [
              {
                "address": "http://10.1.1.1:1102/gelf",
                "type": "gelf",
                "network": "http",
                "level": "info"
              }
            ]
          }
        ]
      }
    }
  }
}

```

### CtrlD Logging Configuration

When you configure a plugin alias in RBFS, the log message is forwarded to CtrlD. CtrlD forwards it to the corresponding the log management server endpoint alias that you configured.

You must add the log management server endpoint in the CtrlD start-up configuration before configuring a plugin-alias in RBFS.



If the configured plugin-alias name does not match any of the log management server endpoint name configured in CtrlD, the log is sent to the default the log management server endpoint

```
| ("graylog_url").
```

For Graylog support, you need to configure logging in the CtrlID.

RBFS logs can be sent to the log management server servers. This can be achieved by configuring a plugin alias in CtrlID.

The following section describe the tasks to be performed to configure the plugin alias in CtrlID:

### config.json

This section describes the main configuration file of CtrlID. This file can be changed via API. If it is changed on the file system, CtrlID has to be restarted.

#### */etc/rtbrick/ctrlid/config.json example*

```
{
  "graylog_enable": true,
  "graylog_url": "http://198.51.100.149:12201/gelf",
  "graylog_endpoints": [
    {
      "name": "ztp",
      "url": "http://198.51.100.146:12201/gelf"
    }
  ]
}
```

#### */etc/rtbrick/ctrlid/config.json format*

Name	Type	Description
<b>graylog_enable</b>	bool	To Enable all Graylog outgoing messages
<b>graylog_url</b>	string	Graylog url e.g. <a href="http://198.51.100.11:12201/gelf">http://198.51.100.11:12201/gelf</a>
<b>graylog_heart_beat_interval</b>	string	Graylog heartbeat Interval in seconds ( 0 means deactivated)

Name	Type	Description	
<b>graylog_endpoints</b>	GraylogEndpoints allows to specify multiple graylog endpoints by name. If a log to a specific endpoint is requested and the endpoint is not available, the log is send to the default Graylog endpoint.		
	Name	Type	Description
	<b>name</b>	string	Logical name of the entpoint e.g.: ztp for ztp messages.
	<b>url</b>	string	Graylog url e.g. <a href="http://198.51.100.11:12201/gelf">http://198.51.100.11:12201/gelf</a>
	<b>disable</b>	string	Disables this endpoint.
If the default endpoint is disabled, but the specific one is enabled than the message to the specific endpoint will be sent.			
If the default endpoint is enabled, but the specific one is disabled than the message to the specific endpoint will not be sent.			

### 17.2.3. Logging Operational Commands

The logging operational commands provide information about the logging operations. They are used to show logs in the system, log configuration status and so on.

#### BDS Logging

The BDS logging show commands provide information about the BDS logging operations. With the BDS logging operational commands, you can verify BDS logging configuration status and view BDS logs.

#### Verifying BDS Logging Configuration Status

##### Show Log Status

This command shows log configuration status for all modules except infrastructure

modules in all BDs. The default `show log status` displays the summary of log status for the whole system and there are options available to show specific module or BD log status.

**Syntax:**

`show log status <attribute> <value>`

Option	Description
-	Without any option, the command displays the log configuration status for all modules except infrastructure modules in all BDs.
bd <bd-name>	Displays log status of the all modules including infrastructure in the specified BD.
detail	Displays the log configuration status in detail all the way till log IDs.
module <module-name>	Displays the log status for a given module in all BDs where this module is running.

**Example 1: Summary of log status**

```

supervisor@rtbrick: cfg> show log status
Module log status:
  bds_mock:
    confd:
      Level: error, Plugin: None, Plugin Level: none
      Log group status:
        Group          Level      Plugin          Plugin Level  Rate limit
        generic         error     None            none          10
  bgp:
    confd:
      Level: error, Plugin: None, Plugin Level: none
      Log group status:
        Group          Level      Plugin          Plugin Level  Rate limit
        config         error     None            none          10
        general        error     None            none          10
        generic         error     None            none          10
        instance       error     None            none          10
        interface      warning   None            none          10
        message        error     None            none          10
        peer           error     None            none          10
  bgp.appd.1:
    Level: error, Plugin: None, Plugin Level: none
    Log group status:
      Group          Level      Plugin          Plugin Level  Rate limit
      config         error     None            none          10
      general        error     None            none          10
      generic         error     None            none          10
      instance       error     None            none          10
      interface      warning   None            none          10
      message        error     None            none          10
      peer           error     None            none          10
    
```

```

bgp.iod.1:
Level: error, Plugin: None, Plugin Level: none
Log group status:
  Group          Level      Plugin          Plugin Level    Rate limit
  config         error     None            none            10
  general        error     None            none            10
  generic        error     None            none            10
  instance       error     None            none            10
  interface      warning  None            none            10
  message        error     None            none            10
  peer           error     None            none            10

fib:
  confd:
    Level: error, Plugin: None, Plugin Level: none
    Log group status:
      Group          Level      Plugin          Plugin Level    Rate limit
      adjacency     error     None            none            10
      bds            error     None            none            10
      config         error     None            none            10
      general        error     None            none            10
      generic        error     None            none            10
      instance-afi-safi error     None            none            10
      interface-events error     None            none            10
      route         error     None            none            10

  fwdinfra:
    ribd:
      Level: error, Plugin: None, Plugin Level: none
      Log group status:
        Group          Level      Plugin          Plugin Level    Rate limit
        generic        error     None            none            10

    confd:
      Level: error, Plugin: None, Plugin Level: none
      Log group status:
        Group          Level      Plugin          Plugin Level    Rate limit
        generic        error     None            none            10

  staticd:
    Level: error, Plugin: None, Plugin Level: none
    Log group status:
      Group          Level      Plugin          Plugin Level    Rate limit
      generic        error     None            none            10

  ifmd:
    Level: error, Plugin: None, Plugin Level: none
    Log group status:
      Group          Level      Plugin          Plugin Level    Rate limit
      generic        error     None            none            10

  mribd:
    Level: error, Plugin: None, Plugin Level: none
    Log group status:
      Group          Level      Plugin          Plugin Level    Rate limit
      generic        error     None            none            10

hostconfd:
  confd:
    Level: error, Plugin: None, Plugin Level: none
    Log group status:
      Group          Level      Plugin          Plugin Level    Rate limit
      bds            error     None            none            10
      config         error     None            none            10
      functional     error     None            none            10
      generic        error     None            none            10

  ifm:
    confd:
      Level: error, Plugin: None, Plugin Level: none
      Log group status:
        Group          Level      Plugin          Plugin Level    Rate limit
        bds            error     None            none            10
        config         error     None            none            10
        general        error     None            none            10
        generic        error     None            none            10
        interface-events error     None            none            10

  ifmd:

```

```

Level: error, Plugin: None, Plugin Level: none
Log group status:
  Group          Level      Plugin          Plugin Level  Rate limit
  bds            error     None            none          10
  config         error     None            none          10
  general        error     None            none          10
  generic        error     None            none          10
  interface-events error     None            none          10
igmp:
pim.appd.1:
Level: error, Plugin: None, Plugin Level: none
Log group status:
  Group          Level      Plugin          Plugin Level  Rate limit
  config         error     None            none          10
  generic        error     None            none          10
  igmp-interface-events error     None            none          10
  igmp-membership-events error     None            none          10
  igmp-packet-events error     None            none          10
  igmp-route-events error     None            none          10
confd:
Level: error, Plugin: None, Plugin Level: none
Log group status:
  Group          Level      Plugin          Plugin Level  Rate limit
  config         error     None            none          10
  generic        error     None            none          10
  igmp-interface-events error     None            none          10
  igmp-membership-events error     None            none          10
  igmp-packet-events error     None            none          10
  igmp-route-events error     None            none          10
igmp.appd.1:
Level: error, Plugin: None, Plugin Level: none
Log group status:
  Group          Level      Plugin          Plugin Level  Rate limit
  config         error     None            none          10
  generic        error     None            none          10
  igmp-interface-events error     None            none          10
  igmp-membership-events error     None            none          10
  igmp-packet-events error     None            none          10
  igmp-route-events error     None            none          10
pim.iod.1:
Level: error, Plugin: None, Plugin Level: none
Log group status:
  Group          Level      Plugin          Plugin Level  Rate limit
  config         error     None            none          10
  generic        error     None            none          10
  igmp-interface-events error     None            none          10

```

### Example 2: View of module log status

```

supervisor@rtbrick: cfg> show log status module bgp
Module log status:
bgp:
confd:
Level: error, Plugin: None, Plugin Level: none
Log group status:
  Group          Level      Plugin          Plugin Level  Rate limit
  config         error     None            none          10
  general        error     None            none          10
  generic        error     None            none          10
  instance       error     None            none          10
  interface      warning   None            none          10
  message        error     None            none          10
  peer           error     None            none          10
bgp.appd.1:
Level: error, Plugin: None, Plugin Level: none
Log group status:
  Group          Level      Plugin          Plugin Level  Rate limit

```

```

config          error      None      none      10
general        error      None      none      10
generic        error      None      none      10
instance       error      None      none      10
interface      warning   None      none      10
message        error      None      none      10
peer           error      None      none      10
bgp.iod.1:
Level: error, Plugin: None, Plugin Level: none
Log group status:
  Group          Level      Plugin      Plugin Level  Rate limit
config          error      None      none          10
general        error      None      none          10
generic        error      None      none          10
instance       error      None      none          10
interface      warning   None      none          10
message        error      None      none          10
peer           error      None      none          10

```

Example 3: Log status of the all modules including infrastructure in the specified BD.

```

supervisor@rtbrick: cfg> show log status bd bgp.appd.1
System/File log status:
Level: error

Module log status:
bd:
Level: none, Plugin: None, Plugin Level: none
Log group status:
  Group          Level      Plugin      Level      Rate limit
generic         none      None      none      10
http            none      None      none      10
bds:
Level: none, Plugin: None, Plugin Level: none
Log group status:
  Group          Level      Plugin      Level      Rate limit
generic         none      None      none      10
object          none      None      none      10
table           none      None      none      10
trim            none      None      none      10
bgp:
Level: error, Plugin: None, Plugin Level: none
Log group status:
  Group          Level      Plugin      Level      Rate limit
config          error      None      none      10
general        error      None      none      10
generic        error      None      none      10
instance       error      None      none      10
interface      warning   None      none      10
message        error      None      none      10
peer           error      None      none      10
license:
Level: error, Plugin: None, Plugin Level: none
Log group status:
  Group          Level      Plugin      Level      Rate limit
generic         error      None      none      10
internal        error      None      none      10
operational     error      None      none      10
policy:
Level: error, Plugin: None, Plugin Level: none
Log group status:
  Group          Level      Plugin      Level      Rate limit
BDS             error      None      none      10
Configuration   error      None      none      10

```

```

Enforcement          error          None          none          10
Generation           error          None          none          10
generic              error          None          none          10
poold:
  Level: error, Plugin: None, Plugin Level: none
  Log group status:
    Group             Level          Plugin          Level          Rate limit
    generic           error          None            none          10
pubsub:
  Level: none, Plugin: None, Plugin Level: none
  Log group status:
    Group             Level          Plugin          Level          Rate limit
    generic           none          None            none          10
secure_management:
  Level: error, Plugin: None, Plugin Level: none
  Log group status:
    Group             Level          Plugin          Level          Rate limit
    generic           error          None            none          10
snapshot:
  Level: error, Plugin: None, Plugin Level: none
  Log group status:
    Group             Level          Plugin          Level          Rate limit
    generic           error          None            none          10
time_series:
  Level: error, Plugin: None, Plugin Level: none
  Log group status:
    Group             Level          Plugin          Level          Rate limit
    generic           error          None            none          10

```

### Example 4: Log status for given module in the given BD

```

supervisor@rtbrick: cfg> show log status module bgp bd bgp.appd.1
Module log status:
  bgp:
    bgp.appd.1:
      Level: error, Plugin: None, Plugin Level: none
      Log group status:
        Group             Level          Plugin          Plugin Level  Rate limit
        config           error          None            none          10
        general          error          None            none          10
        generic          error          None            none          10
        instance        error          None            none          10
        interface        warning       None            none          10
        message          error          None            none          10
        peer             error          None            none          10

```

### Example 5: Log status for active logs per log ID

```

supervisor@rtbrick: cfg> show log status bd bgp.appd.1 detail
System/File log status:
  Level: error

Module log status:
  bd:
    Level: none, Plugin: None, Plugin Level: none
    Log group status:
      generic, Level: none, Plugin: None, Plugin Level: none, Rate limit: 10
      http, Level: none, Plugin: None, Plugin Level: none, Rate limit: 10
    Log ID status:
      LOG ID                                     Level          Plugin
Level      Rate limit
none      HTTP_JWK_FILE_JSON_PARSE_FAILED             none          None
          10
          HTTP_JWK_FILE_MEM_ALLOC_FAILED       none          None

```



```

none      10
          HTTP_JWK_FILE_MISSING                none      None
none      10
          HTTP_JWK_FILE_OPEN_FAILED           none      None
none      10
          HTTP_JWK_FILE_READ_FAILED           none      None
none      10
          HTTP_JWK_MISSING_KEY                none      None
none      10
          HTTP_JWK_MULTIPLE_KEYS              none      None
none      10
          HTTP_SEND                            none      None
none      10
          HTTP_WRITE_BUFFER_MEM_ALLOC_FAILED  none      None
none      10
          HTTP_WRITE_PRINTF_FAILED            none      None
none      10
bds:
  Level: none, Plugin: None, Plugin Level: none
  Log group status:
    generic, Level: none, Plugin: None, Plugin Level: none, Rate limit: 10
  Log ID status:
    LOG ID                                     Level      Plugin
Level      Rate limit
  BDS_ATTRIBUTE_TEMPLATE_EVENT                none      None
none      10
  BDS_INVALID_PARAMS                          none      None
none      10
  BDS_PUBSUB_ERROR_STATUS                     none      None
none      10
  BDS_QUEUE_TABLE                             none      None
none      10
  BDS_ROOT_EVENT                              none      None
none      10
  BDS_TEST_LOG                                none      None
none      10
  object, Level: none, Plugin: None, Plugin Level: none, Rate limit: 10
  Log ID status:
    LOG ID                                     Level      Plugin
Level      Rate limit

```

## Viewing BDS Logs

### Show Log

This command shows BDS logs in the log tables. By default, the command **show log** shows all logs present in the log tables. Various command options are available to filter and display logs. Also, a command option is available to send logs into a file.

### Syntax:

**show log** <option>

Option	Description
-	Without any option, the command displays all logs present in the log tables.

Option	Description
filter <level> <module>	Render output of the log can be filtered for the specified module or the log level. You can specify filter level or module with any of the <b>view log</b> command, so that the logs are filtered based on the specified level or module.
format <abstract  summary  detailed>	Choose any of the three formats: abstract, summary, or detailed. This command provides output in the specified output format. You can specify any of the options at end of any of the <b>view log</b> commands to show logs in a specific output format. By default, summary is the log format. Abstract: Shows logs without metadata Detailed: Shows logs in detail with metadata Summary: Shows logs in summary view with metadata
table <name>	Displays logs from a specified log table. Every BD includes multiple log tables. By default, log will be rendered from every log table, if not specified.
to file <filename>	Name of the file in which logs are transported. You can specify <b>to file</b> and the file name at end of any <b>view log</b> command to transport the log to the file.

### Example 1: View of logs

```

supervisor@rtbrick: op> show log
[ Error ] <2021-07-09T04:35:53.184694+0000> Table [global.hostconfd.table.config] - event Failed to open file
[ Error ] <2021-07-09T04:35:53.184771+0000> Table [global.hostconfd.table.config] - event Could not create snapshot block
[ Error ] <2021-07-09T04:35:53.184849+0000> Table [global.hostconfd.table.config] - event Failed to open file
[ Error ] <2021-07-09T04:35:53.184866+0000> Table [global.hostconfd.table.config] - event Could not create snapshot block
[ Error ] <2021-07-09T04:35:53.201029+0000> Table [global.time-series.config] - event Failed to open file
[ Error ] <2021-07-09T04:35:53.201052+0000> Table [global.time-series.config] - event Could not create snapshot block
[ Error ] <2021-07-09T04:35:53.201106+0000> Table [global.time-series.config] - event Failed to open file
[ Error ] <2021-07-09T04:35:53.201125+0000> Table [global.time-series.config] - event Could not create snapshot block
[ Error ] <2021-07-09T04:35:53.222660+0000> Table [secure.global.system.table.config] - event Failed to open file
[ Error ] <2021-07-09T04:35:53.222679+0000> Table [secure.global.system.table.config] - event Could not create snapshot block
[ Error ] <2021-07-09T04:36:00.720574+0000> Table [global.tacacs.config] Object [name - tacacs_config_object] attribute - tacacs_server_ip not found event TACACS Server Hostconfd Config
    
```

### Example 2: Summary view for the show log table

```

supervisor@rtbrick: op> show log table secure_management.conf.d.log
[ Error ] <Tue Nov 10 19:44:48 GMT +0000 2020> Table [global.tacacs.config] Object [name -
tacacs_config_object] attribute - tacacs_server_ip not found event TACACS Server Hostconfd Config

```

### Example 3: View of applied filters on all logs from a single table

```

supervisor@: op> show log table rtbrick-cli.conf.d.log filter level Info
[ Info ] <Thu Nov 12 11:20:29 GMT +0000 2020> Commit Success
[ Info ] <Thu Nov 12 11:21:08 GMT +0000 2020> Advertise:true | Snapshot type:2 | Table
name:global.system.confrtbrickig.table | Table type:system_config_table | Deferred:false | Interval:0 |
Type:0 | Consume:false
[ Info ] <Thu Nov 12 11:21:08 GMT +0000 2020> No keys to inherit, yang node identifier: table-type
system_config_table, table-getter symbol name : confd_system_config_tbl_tmpl_get , libname : libconfd.so
[ Info ] <Thu Nov 12 11:21:08 GMT +0000 2020> Advertise:true | Snapshot type:2 | Table
name:global.rtbrick.hostname.config | Table type:global_rtbrick_hostname_tbl | Deferred:false | Interval:0 |
Type:0 | Consume:false
[ Info ] <Thu Nov 12 11:21:08 GMT +0000 2020> No keys to inherit, yang node identifier: table-type
global_rtbrick_hostname_tbl, table-getter symbol name : confd_rtbrick_hostname_config_tbl_tmpl_get , libname
: libconfd.so
[ Info ] <Thu Nov 12 11:21:08 GMT +0000 2020> Commit Success

```

### Example 4: Show Log to File

```

supervisor@rtbrick: op> show log to file test.log
supervisor@rtbrick: op> exit
supervisor@rtbrick:~ $ cat test.log
[ info ] <2022-05-10T11:53:15.399613+0000> Global config for Instance(default) is added
[ info ] <2022-05-10T11:53:15.400666+0000> Global address family(ipv4, unicast) is added in
Instance(default)
[ info ] <2022-05-10T11:53:15.400711+0000> Global address family(ipv4, multicast) is added in
Instance(default)
[ info ] <2022-05-10T11:53:15.400729+0000> Global address family(ipv4, labeled-unicast) is added in
Instance(default)
[ info ] <2022-05-10T11:53:15.400744+0000> Global address family(ipv6, unicast) is added in
Instance(default)
[ info ] <2022-05-10T11:53:15.400758+0000> Global address family(ipv6, multicast) is added in
Instance(default)
[ info ] <2022-05-10T11:53:15.400773+0000> Global address family(ipv6, labeled-unicast) is added in
Instance(default)
[ info ] <2022-05-10T11:53:15.400787+0000> Global address family(mpls, unicast) is added in
Instance(default)
[ info ] <2022-05-10T11:53:07.757687+0000> User 'supervisor' executed command 'show log'
[ info ] <2022-05-10T11:53:10.751083+0000> User 'supervisor' executed command 'show log'
[ info ] <2022-05-10T11:53:15.338391+0000> Failed due to bds events- {table:global_ntp_config_tbl}
[ info ] <2022-05-10T11:53:15.338442+0000> Failed due to bds events- {table:ipmi_user_config_table}
[ info ] <2022-05-10T11:53:15.338469+0000> Failed due to bds events- {table:lum_config_table}
[ info ] <2022-05-10T11:53:15.338491+0000> Failed due to bds events- {table:ipmi_interface_config_table}
[ info ] <2022-05-10T11:53:15.338509+0000> Failed due to bds events- {table:authorization_config_table}
[ info ] <2022-05-10T11:53:07.644676+0000> Commit Success
[ info ] <2022-05-10T11:53:15.337573+0000> Table - global_tacacs_config_tbl object not found event
secure_hostconfd_write_config
[ info ] <2022-05-10T11:53:15.337602+0000> Table [global.tacacs.config] Object [name -
tacacs_config_object] attribute - tacacs_server_ip not found event TACACS Server Hostconfd Config
[ info ] <2022-05-10T11:53:15.337241+0000> No objects present in alert configuration table to send to
hostconfd

```

### Example 5: Logs for filter level

```

supervisor@rtbrick: op> show log filter level Error
[ Error ] <Tue Nov 10 19:44:31 GMT +0000 2020> Table
[/var/rtbrick/commit_registry/global.commit.registry.snap] - event Could not open file for reading
[ Error ] <Tue Nov 10 19:44:48 GMT +0000 2020> Table [global.tacacs.config] Object [name -
tacacs_config_object] attribute - tacacs_server_ip not found event TACACS Server Hostconfd Config

```

## Example 6: Logs for specified module

```
supervisor@rtbrick: op> show log filter module secure_management
[ Error ] <Tue Nov 10 19:44:48 GMT +0000 2020> Table [global.tacacs.config] Object [name -
tacacs_config_object] attribute - tacacs_server_ip not found event TACACS Server Hostconfd Config
supervisor@leaf: op>
```

## Example 7: View of the logs in abstract format

```
supervisor@rtbrick: op> show log format abstract
Table [/var/rtbrick/commit_registry/global.commit.registry.snap] - event Could not open file for reading
Commit Success
CLI candidate config deletion begin
CLI candidate config deletion ends, status : success
CLI candidate config addition begin
Advertise:true | Snapshot type:2 | Table name:global.system.config.table | Table type:system_config_table |
Deferred:false | Interval:0 | Type:0 | Consume:false
No keys to inherit, yang node identifier: table-type system_config_table, table-getter symbol name :
confd_system_config_tbl_tmpl_get , libname : libconfd.so
Setting attribute > Table name : global.system.config.table, object : system_config_object, command-token-
name : name, attribute-name : configuration_name, value : rtbrick, type : string
BDS object found
Processing TARGET transaction and replaying ADD, xml_name : system
Setting attribute > Table name : global.system.config.table, object : system_config_object, command-token-
name : name, attribute-name : configuration_name, value : rtbrick, type : string
Table name global.system.config.table, object name system_config_object
Table name global.system.config.table, object name system_config_object, status success
Advertise:true | Snapshot type:2 | Table name:global.rtbrick.hostname.config | Table
type:global_rtbrick_hostname_tbl | Deferred:false | Interval:0 | Type:0 | Consume:false
No keys to inherit, yang node identifier: table-type global_rtbrick_hostname_tbl, table-getter symbol name :
confd_rtbrick_hostname_config_tbl_tmpl_get , libname : libconfd.so
```

## BDS Logging Clear Commands

Clear commands allow you to delete existing logs.

### Clear Logs

This commands resets all logs.

Syntax:

**clear log** <option> ...

Option	Description
bd <bd-name>	Clear all BDS logs from the given BD.
table <table-name>	Clears the specified log table.

## Viewing ONL Log Files

ONL log files are available at the following directory:

CtrlID log files are available at:

[/var/log/rtbrick-ctrlid.log`](#)

Example: CtrlID Logs

```

supervisor@onl>ufi06.q2c.u25.r4.nbg.rtbrick.net:/var/log $ tail -10 rtbrick-ctrlid.log
2022-05-04 08:31:24 UTC INF HTTP request completed host=198.51.100.29:19091
method=GET
path=/api/v1/rbfs/elements/ufi06.q2c.u25.r4.nbg.rtbrick.net/services/prometheus/proxy/federate remote_addr=198.51.100.49:41508 request_id=R4n9-tadb statuscode=200
user_name= user_subject=
2022-05-04 08:31:24 UTC INF HTTP request completed host=198.51.100.29:19091
method=GET path=/api/v1/ctrlid/info remote_addr=198.51.100.121:34158
request_id=yFn9Ptadb statuscode=200 user_name= user_subject=
2022-05-04 08:31:24 UTC INF HTTP request completed host=198.51.100.31:19091
method=GET path=/api/v1/ctrlid/system/clock remote_addr=198.51.100.10:57824
request_id=_cno-gadu statuscode=200 user_name= user_subject=
2022-05-04 08:31:25 UTC INF HTTP request completed host=198.51.100.29:19091
method=GET path=/api/v1/rbfs/elements/rtbrick/services/PROMETHEUS/proxy/federate remote_addr=198.51.100.229:39654 request_id=DXSoPgaHu statuscode=404 user_name=
user_subject=
2022-05-04 08:31:29 UTC INF HTTP request completed host=198.51.100.29:19091
method=GET
path=/api/v1/rbfs/elements/ufi06.q2c.u25.r4.nbg.rtbrick.net/services/prometheus/proxy/federate remote_addr=198.51.100.49:41508 request_id=iQgo-gaHu statuscode=200
user_name= user_subject=
2022-05-04 08:31:34 UTC INF HTTP request completed host=198.51.100.29:19091
method=GET
path=/api/v1/rbfs/elements/ufi06.q2c.u25.r4.nbg.rtbrick.net/services/prometheus/proxy/federate remote_addr=198.51.100.49:41508 request_id=LWM9PgrHb statuscode=200
user_name= user_subject=

```

ApiGwD log files are available at:

[/var/log/rtbrick-apigwd.log](#)

Example: API Gateway Logs

```

supervisor@onl>ufi06.q2c.u25.r4.nbg.rtbrick.net:/var/log $ cat rtbrick-apigwd.log
Tue May 3 23:27:12 UTC 2022 Starting rtbrick apigwd service
Version: v0.10.0-internal.20220222110916+Bdevelopment.C2a896336 (built with
gol.17.7)
2022-05-03 23:27:12 UTC INF development/apigwd/pkg/options/options.go:158 >
watching for file change /etc/rtbrick/apigwd/config.json
2022-05-03 23:27:12 UTC INF development/apigwd/cmd/apigwd/server.go:29 > listening
on listen_addr=:12321
2022-05-03 23:27:12 UTC INF development/apigwd/cmd/apigwd/server.go:89 > certman:
certificate and key loaded
2022-05-03 23:27:12 UTC INF development/apigwd/cmd/apigwd/server.go:89 > certman:
watching for cert and key change
2022-05-03 23:28:15 UTC INF development/apigwd/pkg/options/options.go:165 > watch
event: {/etc/rtbrick/apigwd/config.json 2}

```

```
2022-05-03 23:28:15 UTC INF development/apigwd/pkg/options/options.go:165 > watch
event: {/etc/rtbrick/apigwd/config.json 2}
2022-05-03 23:28:15 UTC INF development/apigwd/cmd/apigwd/routes.go:62 > reloaded
request limiter config
2022-05-03 23:28:15 UTC INF development/apigwd/cmd/apigwd/routes.go:62 > reloaded
request limiter config
```

## Viewing Logs in Graylog

For viewing your log data on Graylog, perform the following steps:

1. Open the Graylog webpage.
2. Log in using your user credentials.

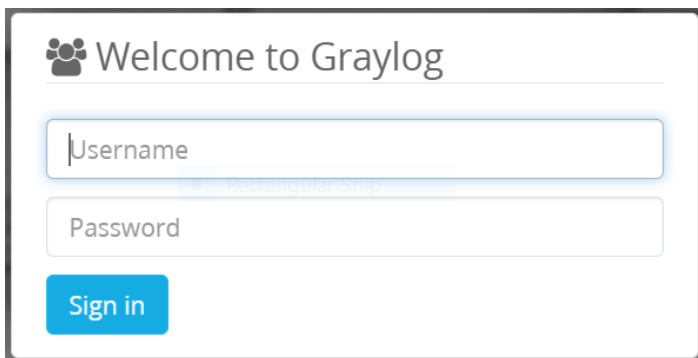

3. Click **System** and select **Input**.

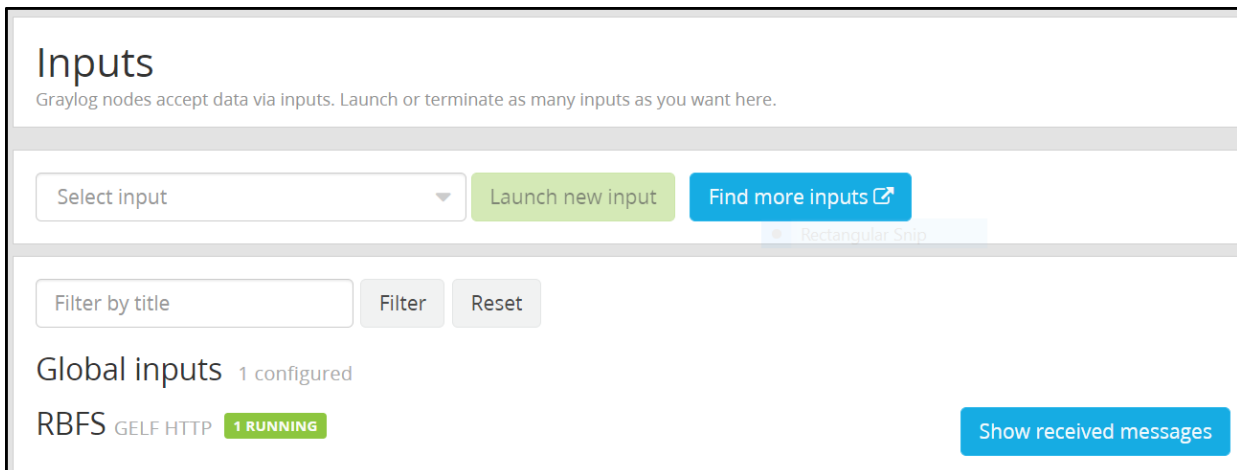

4. Click the **Show received message** tab.

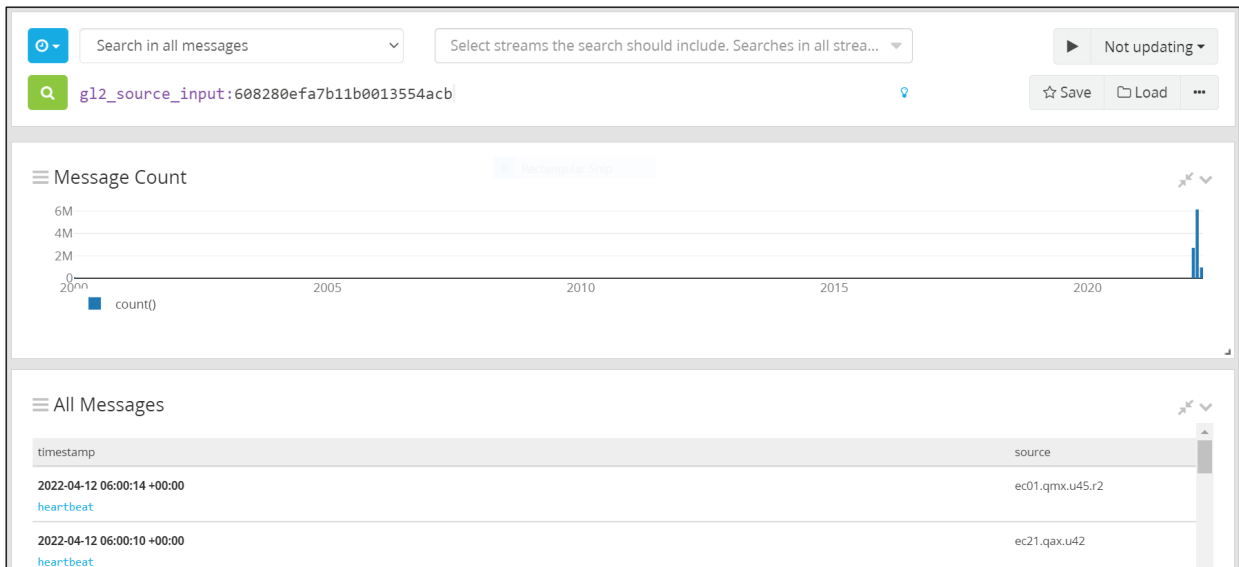

The log messages page appears.

## 17.2.4. RBFS Log Reference

RBFS generates logs for various events. RBFS logs are record of events which occur on different functional components or modules in RBFS.

RBFS logs are categorized based on demons or modules from which they are produced. The following are some of the example scenarios when event logs are generated:

- Failure conditions such as failure in decoding received DHCP relay packet or failure to access a configuration file.
- Normal operations such as when an IPoE subscriber is created or deleted and an interface has been configured and so on.
- Critical conditions such as power failure.

This document provides log information such as log ID, message, description and module, severity level and recommended actions.

**Log Destination** You can locate and view the logs using multiple interfaces which include RBFS command line interface. RBFS also supports exporting logs to external log management servers such as Syslog server and Graylog server for real-time analysis.

You can view the logs in the RBFS command line interface using the **show log** command. Various command options are available to filter and display logs. For

more information, see the [\[loggingug:logging\\_reference:::logging-operational-cmds\]](#) section.

## BD Log Messages

<b>Log ID</b>	HTTP_SEND
<b>Message</b>	Send response for request endpoint %s %s buf count %s state %s
<b>Description</b>	Sent response details.
<b>Log Module</b>	bd
<b>Log Group</b>	http
<b>Severity</b>	INFO
<b>Recommended Actions</b>	No action required.

<b>Log ID</b>	HTTP_JWK_FILE_READ_FAILED
<b>Message</b>	Failed to read keys from JWK file %s
<b>Description</b>	Failed to read keys from the JSON Web Key (JWK) file.
<b>Log Module</b>	bd
<b>Log Group</b>	http
<b>Severity</b>	ERROR
<b>Recommended Actions</b>	Contact RtBrick Customer Support.

<b>Log ID</b>	HTTP_JWK_MULTIPLE_KEYS
<b>Message</b>	Multiple keys in JWK secret file
<b>Description</b>	Multiple keys in the JSON Web Key secret file.
<b>Log Module</b>	bd
<b>Log Group</b>	http
<b>Severity</b>	ERROR
<b>Recommended Actions</b>	Contact RtBrick Customer Support



<b>Log ID</b>	HTTP_JWK_FILE_MISSING
<b>Message</b>	JSON Web Key file %s not found
<b>Description</b>	The JSON Web Key file is not available.
<b>Log Module</b>	bd
<b>Log Group</b>	http
<b>Severity</b>	ERROR
<b>Recommended Actions</b>	Contact RtBrick Customer Support.

<b>Log ID</b>	HTTP_JWK_FILE_MEM_ALLOC_FAILED
<b>Message</b>	Memory error: unable to allocate %s bytes
<b>Description</b>	Unable to allocate memory to read the JSON Web Key file.
<b>Log Module</b>	bd
<b>Log Group</b>	http
<b>Severity</b>	ERROR
<b>Recommended Actions</b>	Contact RtBrick Customer Support.

<b>Log ID</b>	HTTP_JWK_FILE_OPEN_FAILED
<b>Message</b>	Unable to open JWK file %s
<b>Description</b>	Unable to open the JSON Web Key file.
<b>Log Module</b>	bd
<b>Log Group</b>	http
<b>Severity</b>	ERROR
<b>Recommended Actions</b>	Contact RtBrick customer support.

<b>Log ID</b>	HTTP_JWK_MISSING_KEY
<b>Message</b>	Key missing in JWK secret file
<b>Description</b>	Key is missing in the JSON web key secret file.
<b>Log Module</b>	bd

<b>Log Group</b>	http
<b>Severity</b>	ERROR
<b>Recommended Actions</b>	Contact RtBrick customer support.

<b>Log ID</b>	HTTP_JWK_FILE_JSON_PARSE_FAILED
<b>Message</b>	Failed to parse json content from JWK file %s
<b>Description</b>	Failed to parse the JSON content from the JWK file.
<b>Log Module</b>	bd
<b>Log Group</b>	http
<b>Severity</b>	ERROR
<b>Recommended Actions</b>	Contact RtBrick customer support.

<b>Log ID</b>	HTTP_WRITE_BUFFER_MEM_ALLOC_FAILED
<b>Message</b>	Failed to allocate memory for HTTP write buffer of size %s
<b>Description</b>	Failed to allocate memory for the HTTP write buffer.
<b>Log Module</b>	bd
<b>Log Group</b>	http
<b>Severity</b>	ERROR
<b>Recommended Actions</b>	Contact RtBrick customer support.

<b>Log ID</b>	HTTP_WRITE_PRINTF_FAILED
<b>Message</b>	Failed to write data to http write buffer
<b>Description</b>	Failed to write data to the HTTP write buffer.
<b>Log Module</b>	bd
<b>Log Group</b>	http
<b>Severity</b>	ERROR
<b>Recommended Actions</b>	Contact RtBrick customer support.

<b>Log ID</b>	HTTP_RESP_INSUFFICIENT_BUFFER
<b>Message</b>	Failed to read response body, body len: %s input buffer len: %s
<b>Description</b>	Failed to read response body due to insufficient buffer
<b>Log Module</b>	bd
<b>Log Group</b>	http
<b>Severity</b>	ERROR
<b>Action</b>	Contact Rtbrick customer support

<b>Log ID</b>	BD_SERVICE_START
<b>Message</b>	Launch service %s, PID %s
<b>Description</b>	Launch new service
<b>Log Module</b>	bd
<b>Log Group</b>	service-launch
<b>Severity</b>	NOTICE
<b>Recommended Action</b>	Contact Rtbrick customer support.

<b>Log ID</b>	BD_SERVICE_START_FAILED
<b>Message</b>	Failed to launch service %s
<b>Description</b>	Failed launch new service
<b>Log Module</b>	bd
<b>Log Group</b>	service-launch
<b>Severity</b>	ERROR
<b>Recommended Action</b>	Contact Rtbrick customer support.

<b>Log ID</b>	BD_SERVICE_STOP
<b>Message</b>	Terminate service %s
<b>Description</b>	Terminate service
<b>Log Module</b>	bd

<b>Log Group</b>	service-launch
<b>Severity</b>	NOTICE
<b>Recommended Action</b>	Contact Rtbrick customer support.

<b>Log ID</b>	BD_SERVICE_STOP_FAILED
<b>Message</b>	Failed to terminate service %s
<b>Description</b>	Terminate service
<b>Log Module</b>	bd
<b>Log Group</b>	service-launch
<b>Severity</b>	ERROR
<b>Recommended Action</b>	Contact Rtbrick customer support

<b>Log ID</b>	BD_SERVICE_START_REQUEST
<b>Message</b>	%s module requested to launch %s service
<b>Description</b>	Service launch request from module
<b>Log Module</b>	bd
<b>Log Group</b>	service-launch
<b>Severity</b>	INFO
<b>Recommended Action</b>	Contact Rtbrick customer support

<b>Log ID</b>	BD_SERVICE_STOP_REQUEST
<b>Message</b>	%s module requested to terminate service %s
<b>Description</b>	Service terminate request from module.
<b>Log Module</b>	bd
<b>Log Group</b>	service-launch
<b>Severity</b>	INFO

<b>Recommended Action</b>	Contact Rtrbrick customer support
---------------------------	-----------------------------------

## BGP Log Messages

<b>Log ID</b>	BGP_PEER_STATE_CHANGE
<b>Message</b>	BGP FSM change, peer %s, source %s, hostname %s, instance %s changed state from %s to %s, reason %s
<b>Description</b>	BGP FSM state has been changed.
<b>Log Module</b>	bgp
<b>Log Group</b>	peer
<b>Severity</b>	Alert
<b>Recommended Actions</b>	If the session is down, verify the reachability of the peer router.

<b>Log ID</b>	BGP_IFL_NBR_ADD
<b>Message</b>	Link-local peer %s discovered on interface %s, instance %s
<b>Description</b>	BGP link-local peer is discovered on the interface.
<b>Log Module</b>	bgp
<b>Log Group</b>	peer
<b>Severity</b>	Notice
<b>Recommended Actions</b>	No action required

<b>Log ID</b>	BGP_IFL_NBR_DEL
<b>Message</b>	Link-local peer %s deleted on interface %s, instance %s
<b>Description</b>	BGP link-local peer has been deleted on the interface.
<b>Log Module</b>	bgp
<b>Log Group</b>	peer
<b>Severity</b>	Notice
<b>Recommended Actions</b>	No action required

<b>Log ID</b>	BGP_PEER_RESET
<b>Message</b>	BGP peer %s, source %s, hostname %s, instance %s reset, reason %s
<b>Description</b>	BGP session reset occurred.
<b>Log Module</b>	bgp
<b>Log Group</b>	peer
<b>Severity</b>	Notice
<b>Recommended Actions</b>	If the session is down, verify the reachability of the peer.

<b>Log ID</b>	BGP_PEER_RESET_FSM_ERR
<b>Message</b>	BGP peer %s, source %s, hostname %s, instance %s reset, reason FSM error subcode %s, message type %s
<b>Description</b>	BGP session reset occurred due to an FSM error.
<b>Log Module</b>	bgp
<b>Log Group</b>	peer
<b>Severity</b>	Info
<b>Recommended Actions</b>	No action required

<b>Log ID</b>	BGP_MSG_OPEN_VERSION
<b>Message</b>	BGP peer %s, source %s, hostname %s, instance %s received open message with version %s
<b>Description</b>	Received a BGP Open message with an unsupported version number. Only version 4 is supported.
<b>Log Module</b>	bgp
<b>Log Group</b>	peer
<b>Severity</b>	Info
<b>Recommended Actions</b>	Check whether the other BGP peer supports the BGP version 4.

<b>Log ID</b>	BGP_MSG_OPEN_IDENTIFIER
---------------	-------------------------

<b>Message</b>	BGP Open message received with bad identifier %s
<b>Description</b>	BGP Open message is received with a bad identifier.
<b>Log Module</b>	bgp
<b>Log Group</b>	peer
<b>Severity</b>	Info
<b>Recommended Actions</b>	Peer router ID and local router ID are configured with the same value, update the configuration correctly.

<b>Log ID</b>	BGP_MSG_OPEN_HOLDTIMER
<b>Message</b>	BGP peer %s, source %s, hostname %s, instance %s received open message with illegal hold timer %s
<b>Description</b>	BGP Open message is received with a bad hold timer value.
<b>Log Module</b>	bgp
<b>Log Group</b>	peer
<b>Severity</b>	Info
<b>Recommended Actions</b>	Configure the remote router with a holdtimer value more than '3'.

<b>Log ID</b>	BGP_NO_ROUTER_ID
<b>Message</b>	Router ID is not present in instance %s
<b>Description</b>	BGP Router ID is not present.
<b>Log Module</b>	bgp
<b>Log Group</b>	peer
<b>Severity</b>	Info
<b>Recommended Actions</b>	Configure the local router with the router ID.

<b>Log ID</b>	BGP_NO_LOCAL_AS
<b>Message</b>	Local AS is not configured in instance %s
<b>Description</b>	BGP 'local-as' parameter is not defined in the configuration.
<b>Log Module</b>	bgp

<b>Log Group</b>	peer
<b>Severity</b>	Info
<b>Recommended Actions</b>	Configure the BGP local AS in the BGP peer group.

<b>Log ID</b>	BGP_INVALID_RECEIVED_AS
<b>Message</b>	BGP peer %s, source %s, hostname %s, instance %s received wrong AS %s, expected AS %s
<b>Description</b>	BGP received a wrong AS number from a remote peer.
<b>Log Module</b>	bgp
<b>Log Group</b>	peer
<b>Severity</b>	Info
<b>Recommended Actions</b>	Verify that the 'local-as' parameter is defined in the remote BGP speaker and the 'remote-as' parameter is defined in the peer group configured in the local node are the same.

<b>Log ID</b>	BGP_MSG_MANDATORY_ATTRIBUTE
<b>Message</b>	BGP peer %s, source %s, hostname %s, instance %s received message %s with mandatory parameter %s missing
<b>Description</b>	Mandatory parameter for BGP message is not present.
<b>Log Module</b>	bgp
<b>Log Group</b>	peer
<b>Severity</b>	Info
<b>Recommended Actions</b>	Contact RtBrick customer support with the packet captured from the peer node.

<b>Log ID</b>	BGP_PEER_RESET_MSG_HDR_LEN_ERR
<b>Message</b>	BGP peer %s, source %s, hostname %s, instance %s is reset, reason: invalid message header length %s
<b>Description</b>	BGP peer is reset due to invalid header length.
<b>Log Module</b>	bgp
<b>Log Group</b>	peer



<b>Severity</b>	Info
<b>Recommended Actions</b>	Contact RtBrick customer support with the packet scenario captured from the peer node.

<b>Log ID</b>	BGP_PEER_RESET_INVALID_TYPE
<b>Message</b>	BGP peer %s, source %s, hostname %s, instance %s is reset, reason: invalid message type %s, length %s
<b>Description</b>	BGP peer is reset due to invalid message type.
<b>Log Module</b>	bgp
<b>Log Group</b>	peer
<b>Severity</b>	Info
<b>Recommended Actions</b>	BGP does not support the corresponding feature (message).

<b>Log ID</b>	BGP_PEER_RESET_INVALID_PARAMETER_TYPE
<b>Message</b>	BGP peer %s, source %s, hostname %s, instance %s is reset, reason: invalid optional parameter, message %u, parameter type %u
<b>Description</b>	BGP peer is reset due to invalid optional parameter type.
<b>Log Module</b>	bgp
<b>Log Group</b>	peer
<b>Severity</b>	Info
<b>Recommended Actions</b>	BGP does not support the corresponding feature (message).

<b>Log ID</b>	BGP_PEER_RESET_INVALID_CAP_LEN
<b>Message</b>	BGP peer %s, source %s hostname %s, instance %s is reset, reason: invalid capability type %s, capability length %s
<b>Description</b>	BGP peer is reset due to invalid capability length.
<b>Log Module</b>	bgp
<b>Log Group</b>	peer
<b>Severity</b>	Info

<b>Recommended Actions</b>	Contact customer support with the packet scenario captured from the peer node.
----------------------------	--

<b>Log ID</b>	BGP_DUPLICATE_TCP_ACCEPT
<b>Message</b>	BGP peer %s, source %s, hostname %s, instance %s duplicate accept socket is success.
<b>Description</b>	In this error scenario when one side BGP peer is up and on the other part TCP connection goes down and comes up again.
<b>Log Module</b>	bgp
<b>Log Group</b>	peer
<b>Severity</b>	Info
<b>No action required</b>	Contact Rtbrick customer support

<b>Log ID</b>	BGP_IFL_CHANGE
<b>Message</b>	Interface %s, instance %s received event %s
<b>Description</b>	Interface status has changed.
<b>Log Module</b>	bgp
<b>Log Group</b>	interface
<b>Severity</b>	Info
<b>Recommended Actions</b>	Verify the physical status of the interface.

<b>Log ID</b>	BGP_IFA_CHANGE
<b>Message</b>	Interface %s, instance %s received %s of address %s
<b>Description</b>	Event related to interface address.
<b>Log Module</b>	bgp
<b>Log Group</b>	interface
<b>Severity</b>	Info
<b>Recommended Actions</b>	Verify the physical status of the interface.

<b>Log ID</b>	BGP_INSTANCE_INACTIVE
<b>Message</b>	Instance %s is inactive, reason %s
<b>Description</b>	BGP instance became inactive.
<b>Log Module</b>	bgp
<b>Log Group</b>	instance
<b>Severity</b>	Info
<b>Reco</b>	No action required

<b>Log ID</b>	BGP_MSG_VALIDATION_FAIL
<b>Message</b>	BGP message received from peer %s, source %s, hostname %s, instance %s validation failed. Message type %s
<b>Description</b>	BGP Message validation failed.
<b>Log Module</b>	bgp
<b>Log Group</b>	message
<b>Severity</b>	Info
<b>Recommended Actions</b>	Contact customer support with the packet captured from the peer node.

<b>Log ID</b>	BGP_MSG_DECODE_FAIL
<b>Message</b>	BGP message received from peer %s, source %s, hostname %s, instance %s decode failed. Message type %s
<b>Description</b>	BGP Message decoding has failed.
<b>Log Module</b>	bgp
<b>Log Group</b>	message
<b>Severity</b>	Info
<b>Recommended Actions</b>	Contact customer support with the packet captured from the peer node.

<b>Log ID</b>	BGP_UPD_SET_ERR_INFO
<b>Message</b>	Update processing error. code %s , subcode %s
<b>Description</b>	BGP Update processed error code and subcodes.

<b>Log Module</b>	bgp
<b>Log Group</b>	message
<b>Severity</b>	Info
<b>Recommended Actions</b>	Verify that the feature is supported.

<b>Log ID</b>	BGP_UPD_INVALID_IPV4_PREFIX
<b>Message</b>	BGP update message processing, peer %s, source %s, hostname %s, instance %s: Received invalid prefix %s/%s
<b>Description</b>	BGP Update message is received with an invalid prefix.
<b>Log Module</b>	bgp
<b>Log Group</b>	message
<b>Severity</b>	Info
<b>Recommended Actions</b>	Capture the packet scenario and verify it.

<b>Log ID</b>	BGP_UPD_ATTR_REPEAT
<b>Message</b>	BGP update message processing, peer %s, source %s, hostname %s, instance %s: Attribute %s repeated
<b>Description</b>	BGP Update message is processed with a repeated attribute.
<b>Log Module</b>	bgp
<b>Log Group</b>	message
<b>Severity</b>	Info
<b>Recommended Actions</b>	Verify the neighbor router configurations.

<b>Log ID</b>	BGP_UPD_ATTR_WELLKNOWN_TRANS
<b>Message</b>	BGP update message processing, peer %s, source %s, hostname %s, instance %s: Attribute %s does not have well known transitive flag set
<b>Description</b>	BGP Update process error. Attribute does not have a well known transitive flag set.

<b>Log Module</b>	bgp
<b>Log Group</b>	message
<b>Severity</b>	Info
<b>Recommended Actions</b>	Verify the neighbor router configuration.

<b>Log ID</b>	BGP_UPD_ATTR_WK_TRANS_PARTIAL
<b>Message</b>	BGP update message processing, peer %s, source %s, hostname %s, instance %s: Well known transitive attribute %s has partial bit set
<b>Description</b>	BGP Update processing error: Well known transitive attribute has partial bit set
<b>Log Module</b>	bgp
<b>Log Group</b>	message
<b>Severity</b>	Info
<b>Recommended Actions</b>	Verify the neighbor router configurations.

<b>Log ID</b>	BGP_UPD_ATTR_INVALID_ASPATH_LEN
<b>Message</b>	BGP update message processing, peer %s, source %s, hostname %s, instance %s: Invalid AS path length %s
<b>Description</b>	BGP Update processed Invalid AS path length
<b>Log Module</b>	bgp
<b>Log Group</b>	message
<b>Severity</b>	Info
<b>Recommended Actions</b>	Verify that only 4 byte AS is enabled on peer BGP speakers. RBFS supports only 4 byte AS.

<b>Log ID</b>	BGP_UPD_ENFORCE_FIRST_AS
<b>Message</b>	BGP update message processing, peer %s, source %s, hostname %s, instance %s: First AS %s is not peer AS %s, ignoring

<b>Description</b>	BGP Update processed: 'First AS is not peer AS, so ignore the update' condition.
<b>Log Module</b>	bgp
<b>Log Group</b>	message
<b>Severity</b>	Info
<b>Recommended Actions</b>	Disable 'enforce first AS' attribute, if this is required.

<b>Log ID</b>	BGP_UPD_INVALID_SEG_TYPE
<b>Message</b>	BGP update message processing, peer %s, source %s, hostname %s, instance %s: Invalid path segment type %s
<b>Description</b>	BGP Update processed 'invalid segment type' condition.
<b>Log Module</b>	bgp
<b>Log Group</b>	message
<b>Severity</b>	Info
<b>Recommended Actions</b>	Check whether that the feature is supported.

<b>Log ID</b>	BGP_UPD_INVALID_NH
<b>Message</b>	BGP update message processing, peer %s, source %s, hostname %s, instance %s: Invalid unicast ip address in nexthop %s
<b>Description</b>	BGP Update processing: Invalid unicast ip address in nexthop
<b>Log Module</b>	bgp
<b>Log Group</b>	message
<b>Severity</b>	Info
<b>Recommended Actions</b>	Contact Rtrbrick customer support

<b>Log ID</b>	BGP_UPD_INVALID_IP6_PREFIX
<b>Message</b>	BGP update message processing, peer %s, source %s, hostname %s, instance %s: Invalid prefix %s/%s

<b>Description</b>	BGP Update processed an invalid IPv6 prefix which is received from the peer.
<b>Log Module</b>	bgp
<b>Log Group</b>	message
<b>Severity</b>	Info
<b>Recommended Actions</b>	Capture and verify the packet scenario.

<b>Log ID</b>	BGP_UPD_RCVD_NON_NEGOTIATED_AF
<b>Message</b>	BGP update message processing, peer %s, source %s, hostname %s, instance %s: Received NLRI of non-negotiated address family %s, safi %s
<b>Description</b>	BGP Update processed a non-negotiated address family received from the peer ('Received NLRI of non-negotiated address family')
<b>Log Module</b>	bgp
<b>Log Group</b>	message
<b>Severity</b>	Info
<b>Recommended Actions</b>	Disable the address family on the peer node.

<b>Log ID</b>	BGP_UPD_INVALID_LEN
<b>Message</b>	BGP update message processing, peer %s, source %s, hostname %s, instance %s: Received invalid length %s
<b>Description</b>	BGP Update processed an invalid length which has been received from the peer.
<b>Log Module</b>	bgp
<b>Log Group</b>	message
<b>Severity</b>	Info
<b>Recommended Actions</b>	Check whether the feature is supported.

<b>Log ID</b>	BGP_UPD_MALFORMED_PATH_ATTR
---------------	-----------------------------

<b>Message</b>	BGP update message processing, peer %s, source %s, hostname %s, instance %s: Received malformed path attribute %s, length %s
<b>Description</b>	BGP Update processes a malformed path attribute which has been received.
<b>Log Module</b>	bgp
<b>Log Group</b>	message
<b>Severity</b>	Info
<b>Recommended Actions</b>	Check whether the feature is supported.

<b>Log ID</b>	BGP_UPD_ATTR_EXT_LEN
<b>Message</b>	BGP update message processing, peer %s, source %s, hostname %s, instance %s: Invalid length bit set for attribute %s
<b>Description</b>	BGP Update processed an 'Invalid length bit set for attribute'.
<b>Log Module</b>	bgp
<b>Log Group</b>	message
<b>Severity</b>	Info
<b>Recommended Actions</b>	Check whether the feature is supported.

<b>Log ID</b>	BGP_UPD_ATTR_INVALID_ORIGIN
<b>Message</b>	BGP update message processing, peer %s, source %s, hostname %s, instance %s: Invalid origin attribute value %s
<b>Description</b>	BGP Update processed an invalid 'origin' attribute value.
<b>Log Module</b>	bgp
<b>Log Group</b>	message
<b>Severity</b>	Info
<b>Recommended Actions</b>	Verify the neighbor router configuration.

<b>Log ID</b>	BGP_UPD_ATTR_OPTIONAL_TRANS
---------------	-----------------------------



<b>Message</b>	BGP update message processing, peer %s, source %s, hostname %s, instance %s: Attribute %s does not have optional transitive flag set
<b>Description</b>	BGP Update processed attributes which do not have an optional transitive flag set.
<b>Log Module</b>	bgp
<b>Log Group</b>	message
<b>Severity</b>	Info
<b>Recommended Actions</b>	Verify the neighbor router configuration.

<b>Log ID</b>	BGP_UPD_OWN_ROUTER_ID
<b>Message</b>	BGP update message processing, peer %s, source %s, hostname %s, instance %s: Received own router id %s
<b>Description</b>	BGP Update processed its own router ID which has been received.
<b>Log Module</b>	bgp
<b>Log Group</b>	message
<b>Severity</b>	Info
<b>Recommended Actions</b>	Verify whether the same router ID is configured on both of the BGP speakers.

<b>Log ID</b>	BGP_UPD_ATTR_OPTIONAL_NON_TRANS
<b>Message</b>	BGP update message processing, peer %s, source %s, hostname %s, instance %s: Attribute %s does not have optional non-transitive flag set
<b>Description</b>	BGP Update processed attribute that does not have an optional non-transitive flag set.
<b>Log Module</b>	bgp
<b>Log Group</b>	message
<b>Severity</b>	Info
<b>Recommended Actions</b>	Verify the neighbor router configuration.

<b>Log ID</b>	BGP_UPD_INVALID_ATTR_EBGP
<b>Message</b>	BGP update message processing, peer %s, source %s, hostname %s, instance %s: Received invalid attribute %s from EBGP peer
<b>Description</b>	BGP Update processed an invalid attribute received from eBGP peer router.
<b>Log Module</b>	bgp
<b>Log Group</b>	message
<b>Severity</b>	Info
<b>Recommended Actions</b>	Verify the neighbor router configuration.

<b>Log ID</b>	BGP_UPD_INVALID_SR_IDX_LEN
<b>Message</b>	BGP update message processing, peer %s, source %s, hostname %s, instance %s: Invalid SR index length %s
<b>Description</b>	BGP Update processed an invalid SR index length.
<b>Log Module</b>	bgp
<b>Log Group</b>	message
<b>Severity</b>	Info
<b>Recommended Actions</b>	Verify the neighbor router configuration.

<b>Log ID</b>	BGP_UPD_INVALID_SRGB_LEN
<b>Message</b>	BGP update message processing, peer %s, source %s, hostname %s, instance %s: Invalid SRGB length %s
<b>Description</b>	BGP Update processed an invalid SRGB length.
<b>Log Module</b>	bgp
<b>Log Group</b>	message
<b>Severity</b>	Info
<b>Recommended Actions</b>	Verify the neighbor router configuration.

<b>Log ID</b>	BGP_UPD_PATH_ATTR_FAIL
<b>Message</b>	BGP update message processing, peer %s, source %s, hostname %s, instance %s: Processing path attribute failed
<b>Description</b>	BGP Update processed a failed path attribute.
<b>Log Module</b>	bgp
<b>Log Group</b>	message
<b>Severity</b>	Info
<b>Recommended Actions</b>	This can be a packet decoding problem. Send the captured packet to the Contact RtBrick customer support team for verification.

<b>Log ID</b>	BGP_UPD_MREACH_FAIL
<b>Message</b>	BGP update message processing, peer %s, source %s, hostname %s, instance %s: Processing MPREACH NLRI attribute failed
<b>Description</b>	BGP Update processed a failed MPREACH NLRI attribute.
<b>Log Module</b>	bgp
<b>Log Group</b>	message
<b>Severity</b>	Info
<b>Recommended Actions</b>	This can be a packet decoding problem. Send the captured packet to the Contact RtBrick customer support team for verification.

<b>Log ID</b>	BGP_UPD_INVALID_EXP_LEN
<b>Message</b>	BGP update message processing, peer %s, source %s, hostname %s, instance %s: Received invalid length %s . Expected %s
<b>Description</b>	BGP Update processed an invalid length which has been received.
<b>Log Module</b>	bgp
<b>Log Group</b>	message
<b>Severity</b>	Info

<b>Recommended Actions</b>	This can be a packet decoding problem. Send the captured packet to the Contact RtBrick customer support team for verification.
----------------------------	--

<b>Log ID</b>	BGP_UPD_NLRI_FAIL
<b>Message</b>	BGP update message processing, peer %s, source %s, hostname %s, instance %s: Processing NLRI attribute failed
<b>Description</b>	BGP Update processed a failed NLRI attribute.
<b>Log Module</b>	bgp
<b>Log Group</b>	message
<b>Severity</b>	Info
<b>Recommended Actions</b>	This can be a packet decoding problem. Send the captured packet scenario to the Contact RtBrick customer support team for verification.

<b>Log ID</b>	BGP_FSM_PEER_STATE_CHANGE
<b>Message</b>	Peer [%s] Src[%s] CurState[%s] Event[%s] NextState[%s]
<b>Description</b>	BGP Update processed a failed NLRI attribute.
<b>Log Module</b>	bgp
<b>Log Group</b>	message
<b>Severity</b>	Info
<b>Recommended Actions</b>	This can be a packet decoding problem. Send the captured packet scenario to the Contact RtBrick customer support team for verification.

<b>Log ID</b>	BGP_UPD_FLOWSPEC_INVALID_LEN
<b>Message</b>	BGP flowspec update message processing, peer %s, source %s, hostname %s, instance %s: Received invalid flowspec nlri(%s)
<b>Description</b>	BGP Update processing: Received invalid length
<b>Log Module</b>	bgp
<b>Log Group</b>	message
<b>Severity</b>	Info

<b>Recommended Action</b>	Contact RtBrick customer support
---------------------------	----------------------------------

<b>Log ID</b>	BGP_FLOWSPEC_RECEIVED
<b>Message</b>	Flowspec rule %s received from Peer(peer:%s, src:%s), flowspec hash (%s)
<b>Description</b>	BGP FlowSpec update/withdraw received.
<b>Log Module</b>	bgp
<b>Log Group</b>	flowspec
<b>Severity</b>	debug
<b>Recommended Action</b>	Contact RtBrick customer support.

<b>Log ID</b>	BGP_FLOWSPEC_SEND
<b>Message</b>	FlowSpec rule %s send to Peer(peer:%s, src:%s), (flowspec hash: %s)
<b>Description</b>	BGP Flowspec send to peer.
<b>Log Module</b>	bgp
<b>Log Group</b>	flowspec
<b>Severity</b>	debug
<b>Recommended Action</b>	Contact RtBrick customer support.

<b>Log ID</b>	BGP_FLOWSPEC_RULE_INVALID
<b>Message</b>	Flowspec rule (flowspec hash: %s) not updated.
<b>Description</b>	BGP FlowSpec is not updated.
<b>Log Module</b>	bgp
<b>Log Group</b>	flowspec

<b>Severity</b>	debug
<b>Recommended Action</b>	Contact RtBrick customer support.

<b>Log ID</b>	BGP_FLOWSPEC_ENTRY_DELETED
<b>Message</b>	Flowspec rule (flowspec hash: %s) deleted.
<b>Description</b>	BGP FlowSpec rule is deleted.
<b>Log Module</b>	bgp
<b>Log Group</b>	flowspec
<b>Severity</b>	debug
<b>Recommended Action</b>	Contact RtBrick customer support.

<b>Log ID</b>	BGP_FLOWSPEC_PRIORITY_ADDED
<b>Message</b>	FlowSpec rule (flowspec hash: %s) added at index %s
<b>Description</b>	BGP FlowSpec rule priority is added.
<b>Log Module</b>	bgp
<b>Log Group</b>	flowspec
<b>Severity</b>	debug
<b>Recommended Action</b>	Contact RtBrick customer support

<b>Log ID</b>	BGP_FLOWSPEC_PRIORITY_DELETED
<b>Message</b>	Flowspec rule (flowspec hash: %s) at index %s deleted.
<b>Description</b>	BGP FlowSpec rule priority is deleted.
<b>Log Module</b>	bgp
<b>Log Group</b>	flowspec

<b>Severity</b>	debug
<b>Recommended Action</b>	Contact RtBrick customer support.

<b>Log ID</b>	BGP_FLOWSPEC_PRIORITY_FULL
<b>Message</b>	Flowspec rule (flowspec hash: %s) not sorted as the max rule count %s reached.
<b>Description</b>	BGP Flowspec rule is not sorted.
<b>Log Module</b>	bgp
<b>Log Group</b>	flowspec
<b>Severity</b>	debug
<b>Recommended Action</b>	Contact RtBrick customer support.

<b>Log ID</b>	BGP_FLOWSPEC_PRIORITY_ERROR
<b>Message</b>	Flowspec rule (flowspec hash: %s) not sorted.
<b>Description</b>	BGP FlowSpec rule is not sorted.
<b>Log Module</b>	bgp
<b>Log Group</b>	flowspec
<b>Severity</b>	debug
<b>Recommended Action</b>	Contact RtBrick customer support

<b>Log ID</b>	BGP_FLOWSPEC_PRIORITY_NOT_FOUND
<b>Message</b>	Flowspec rule (flowspec hash: %s) not found in priority sorting.
<b>Description</b>	BGP FlowSpec rule is not found.
<b>Log Module</b>	bgp

<b>Log Group</b>	flowspec
<b>Severity</b>	debug
<b>Recommended Action</b>	Contact RtBrick customer support.

<b>Log ID</b>	BGP_FLOWSPEC_STATUS_INVALID
<b>Message</b>	Status invalid flowspec(%s)
<b>Description</b>	Invalid status.
<b>Log Module</b>	bgp
<b>Log Group</b>	flowspec
<b>Severity</b>	debug
<b>Recommended Action</b>	Contact RtBrick customer support.

<b>Message</b>	Flowspec rule (flowspec hash: %s) added with priority %s and acl count %s
<b>Description</b>	BGP FlowSpec rule has been ACL added.
<b>Log Module</b>	bgp
<b>Log Group</b>	flowspec
<b>Log ID</b>	BGP_FLOWSPEC_ACL_ADDED
<b>Severity</b>	debug
<b>Recommended Action</b>	Contact Rtbrick customer support

<b>Log ID</b>	BGP_FLOWSPEC_ACL_DELETED
<b>Message</b>	Flowspec rule (flowspec hash: %s) deleted with priority %s and acl count %s
<b>Description</b>	BGP FlowSpec rule ACL has been deleted.



<b>Log Module</b>	bgp
<b>Log Group</b>	flowspec
<b>Severity</b>	debug
<b>Recommended Action</b>	Contact Rtbrick customer support

<b>Message</b>	FlowSpec rule (flowspec hash: %s) reinstalled with priority %s and acl count %s
<b>Description</b>	BGP FlowSpec rule ACL has been reinstalled.
<b>Log Module</b>	bgp
<b>Log Group</b>	flowspec
<b>Log ID</b>	BGP_FLOWSPEC_ACL_REINSTALLED
<b>Severity</b>	debug
<b>Recommended Action</b>	Contact Rtbrick customer support

<b>Log ID</b>	BGP_FLOWSPEC_PRIORITY_DELETED
<b>Message</b>	Flowspec rule (flowspec hash: %s) at index %s deleted
<b>Description</b>	BGP Flowspec rule priority deleted
<b>Log Module</b>	bgp
<b>Log Group</b>	flowspec
<b>Severity</b>	debug
<b>Recommended Action</b>	Contact Rtbrick customer support

<b>Log ID</b>	BGP_FLOWSPEC_PRIORITY_UPDATED
<b>Message</b>	Flowspec rule (flowspec hash: %s) priority updated from %s to %s acl-full:%s status:%s
<b>Description</b>	BGP FlowSpec rule priority has been updated.

<b>Log Module</b>	bgp
<b>Log Group</b>	flowspec
<b>Severity</b>	debug
<b>Recommended Action</b>	Contact Rtbrick customer support

## CGNAT Log Messages

<b>Log ID</b>	NAT_LOG_USER_ADDR_PORT_ALLOC
<b>Message</b>	IPv4 Address Allocated, User %s, Original Address %s, Translated Address %s, L4-Port-Range %s - %s
<b>Description</b>	User IPv4 address and port range have been allocated.
<b>Log Module</b>	NAT
<b>Log Group</b>	nat-resource
<b>Severity</b>	notice
<b>Recommended Action</b>	Contact RtBrick customer support

<b>Log ID</b>	NAT_LOG_USER_ADDR_PORT_FREE
<b>Message</b>	IPv4 Address Freed, User %s, Original Address %s, Translated Address %s, L4-Port-Range %s - %s
<b>Description</b>	User IPv4 address and port range are free for next use.
<b>Log Module</b>	NAT
<b>Log Group</b>	nat-resource
<b>Severity</b>	notice
<b>Recommended Action</b>	Contact RtBrick customer support.

<b>Log ID</b>	NAT_LOG_POOL_RESOURCE_STATUS
---------------	------------------------------

<b>Message</b>	Pool exhaustion, status %s, pool %s, instance %s
<b>Description</b>	Resource usage status.
<b>Log Module</b>	NAT
<b>Log Group</b>	nat-resource
<b>Severity</b>	warning
<b>Recommended Action</b>	Contact RtBrick customer support.

<b>Log ID</b>	NAT_LOG_RULE_USAGE_STATUS
<b>Message</b>	Max rules, status %s, subscriber %s
<b>Description</b>	Address translation rules usage status of a subscriber.
<b>Log Module</b>	NAT
<b>Log Group</b>	nat-resource
<b>Severity</b>	notice
<b>Recommended Action</b>	Contact RtBrick customer support

## HOSTCONFD Log Messages

<b>Log ID</b>	HOSTCONFD_BDS_GENERIC_FAIL
<b>Message</b>	Failed due to bds events- {table:%s}
<b>Description</b>	Failed due to a BDS event.
<b>Log Module</b>	hostconfd
<b>Log Group</b>	bds
<b>Severity</b>	INFO
<b>Recommended Actions</b>	Verify the table or object in the BDS commands.

<b>Log ID</b>	HOSTCONFD_TABLE_CONFIG_READ_FAIL
---------------	----------------------------------

<b>Message</b>	Failed to read static hostconfd table configuration- {file:%s}
<b>Description</b>	Failed to read static <b>hostconfd</b> table configuration.
<b>Log Module</b>	hostconfd
<b>Log Group</b>	config
<b>Severity</b>	INFO
<b>Recommended Actions</b>	Verify the <b>json</b> format/table-name in the configuration file.

<b>Log ID</b>	HOSTCONFD_DYN_PLUGIN_REGN_FAIL
<b>Message</b>	Failed to register dynamic plugin- {table-type:%s}
<b>Description</b>	Failed to register dynamic plugin.
<b>Log Module</b>	hostconfd
<b>Log Group</b>	config
<b>Severity</b>	INFO
<b>Recommended Actions</b>	Verify the table definition.

<b>Log ID</b>	HOSTCONFD_HTTP_HEADER_FAIL
<b>Message</b>	Failed to create HTTP header to send to hostconfd {event:%s}
<b>Description</b>	Failed to create HTTP header to send to the <b>hostconfd</b> daemon.
<b>Log Module</b>	hostconfd
<b>Log Group</b>	functional
<b>Severity</b>	INFO
<b>Recommended Actions</b>	Verify the table definition.

<b>Log ID</b>	HOSTCONFD_HTTP_CONTENT_FAIL
<b>Message</b>	Failed to create HTTP content to send to hostconfd- {table-type:%s}
<b>Description</b>	Failed to create HTTP content to send to <b>hostconfd</b> daemon.
<b>Log Module</b>	hostconfd

<b>Log Group</b>	functional
<b>Severity</b>	INFO
<b>Recommended Actions</b>	Verify the table definition.

<b>Log ID</b>	HOSTCONFD_CONNECTION_DOWN
<b>Message</b>	HOSTCONFD connection is DOWN {event:%s}
<b>Description</b>	HOSTCONFD connection is down.
<b>Log Module</b>	hostconfd
<b>Log Group</b>	functional
<b>Severity</b>	INFO
<b>Recommended Actions</b>	Verify the <b>hostconfd</b> operational status.

<b>Log ID</b>	HOSTCONFD_ALERTING_CONFIG_ERROR
<b>Message</b>	HOSTCONFD alert config error {event:%s}
<b>Description</b>	Error generated by <b>hostconfd</b> on alerting about a configuration error.
<b>Log Module</b>	hostconfd
<b>Log Group</b>	functional
<b>Severity</b>	ERROR
<b>Recommended Actions</b>	Verify the <b>hostconfd</b> operational status.

<b>Log ID</b>	IPMI_CONFIG_TABLE_ERROR
<b>Message</b>	Failed to create IPMI config table %s
<b>Description</b>	Failed to create the IPMI configuration table.
<b>Log Module</b>	hostconfd
<b>Log Group</b>	functional
<b>Severity</b>	ERROR
<b>Recommended Actions</b>	Contact RtBrick customer support.

<b>Log ID</b>	WATCHDOG_CONFIG_TABLE_ERROR
<b>Message</b>	Failed to create Watchdog config table %s
<b>Description</b>	Failed to create the watchdog configuration table.
<b>Log Module</b>	hostconfd
<b>Log Group</b>	functional
<b>Severity</b>	ERROR
<b>Recommended Actions</b>	Contact RtBrick Customer Support.

## Interfaces Log Messages

<b>Log ID</b>	IFM_OPER_IFP_ADMIN_UP
<b>Message</b>	Admin status of the physical interface %s is UP
<b>Description</b>	The interface configuration has been changed.
<b>Log Module</b>	ifm
<b>Log Group</b>	config
<b>Severity</b>	info
<b>Recommended Actions</b>	Verify the interface configurations on the physical interface.

<b>Log ID</b>	IFM_OPER_IFP_ADMIN_DOWN
<b>Message</b>	Admin status of the physical interface %s is DOWN
<b>Description</b>	The interface configuration has been changed.
<b>Log Module</b>	ifm
<b>Log Group</b>	config
<b>Severity</b>	info
<b>Recommended Actions</b>	Verify the interface configurations for the physical interface.

<b>Log ID</b>	IFM_OPER_IFP_LINK_UP
<b>Message</b>	Link status of the physical interface %s is UP
<b>Description</b>	Physical link is up on the interface.

<b>Log Module</b>	ifm
<b>Log Group</b>	interface-events
<b>Severity</b>	info
<b>Recommended Actions</b>	Check the physical connectivity for this particular port.

<b>Log ID</b>	IFM_OPER_IFP_LINK_DOWN
<b>Message</b>	Link status of the physical interface %s is DOWN
<b>Description</b>	Physical link is down on the interface.
<b>Log Module</b>	ifm
<b>Log Group</b>	interface-events
<b>Severity</b>	info
<b>Recommended Actions</b>	Check the physical connectivity for this particular port.

<b>Log ID</b>	IFM_OPER_IFP_OPERATIONAL_UP
<b>Message</b>	Operational status of the physical interface %s is UP
<b>Description</b>	Admin-status or operational status of an interface has gone up.
<b>Log Module</b>	ifm
<b>Log Group</b>	interface-events
<b>Severity</b>	info
<b>Recommended Actions</b>	Check the physical connectivity for this particular port or verify the interface configuration.

<b>Log ID</b>	IFM_OPER_IFP_OPERATIONAL_DOWN
<b>Message</b>	Operational status of the physical interface %s is DOWN
<b>Description</b>	Admin-status or operational status of an interface has gone down.
<b>Log Module</b>	ifm
<b>Log Group</b>	interface-events
<b>Severity</b>	info

<b>Recommended Actions</b>	Check the physical connection for this particular port or the interface configuration
----------------------------	---

<b>Log ID</b>	IFM_OPER_IFL_ADMIN_UP
<b>Message</b>	Admin status of the logical interface %s is UP
<b>Description</b>	Logical interface configuration has been changed.
<b>Log Module</b>	ifm
<b>Log Group</b>	config
<b>Severity</b>	info
<b>Recommended Actions</b>	Verify the interface configurations for this logical interface.

<b>Log ID</b>	IFM_OPER_IFL_ADMIN_DOWN
<b>Message</b>	Admin status of the logical interface %s is DOWN
<b>Description</b>	The logical interface configuration has been changed.
<b>Log Module</b>	ifm
<b>Log Group</b>	config
<b>Severity</b>	info
<b>Recommended Actions</b>	Check the interface configurations for this logical interface.

<b>Log ID</b>	IFM_OPER_IFL_LINK_UP
<b>Message</b>	Link status of the logical interface %s is UP
<b>Description</b>	Link is up on the logical interface.
<b>Log Module</b>	ifm
<b>Log Group</b>	interface-events
<b>Severity</b>	info
<b>Recommended Actions</b>	Check the connectivity for this particular logical interface.

<b>Log ID</b>	IFM_OPER_IFL_LINK_DOWN
<b>Message</b>	The link status of the logical interface %s is DOWN



<b>Description</b>	Link is down on the logical interface.
<b>Log Module</b>	ifm
<b>Log Group</b>	interface-events
<b>Severity</b>	info
<b>Recommended Actions</b>	Check the connectivity for this particular logical interface.

<b>Log ID</b>	IFM_OPER_IFL_OPERATIONAL_UP
<b>Message</b>	Operational status of the logical interface %s is UP
<b>Description</b>	Admin-status or operational status of a logical interface has gone up.
<b>Log Module</b>	ifm
<b>Log Group</b>	interface-events
<b>Severity</b>	info
<b>Recommended Actions</b>	Check the connectivity for this particular port or verify the logical interface configuration.

<b>Log ID</b>	IFM_OPER_IFL_OPERATIONAL_DOWN
<b>Message</b>	The operational status of the logical interface %s is DOWN
<b>Description</b>	Admin-status or operational status of a logical interface has gone down.
<b>Log Module</b>	ifm
<b>Log Group</b>	interface-events
<b>Severity</b>	info
<b>Recommended Actions</b>	Check the physical connectivity for this particular port or verify the logical interface configuration.

<b>Log ID</b>	IFM_OPER_IFL_IPV4_STATUS_UP
<b>Message</b>	IPv4 status of the logical interface %s is UP
<b>Description</b>	IPv4 service has been enabled on a logical interface.
<b>Log Module</b>	ifm
<b>Log Group</b>	config

<b>Severity</b>	info
<b>Recommended Actions</b>	Verify the IPv4 status for this logical interface.

<b>Log ID</b>	IFM_OPER_IFL_IPV4_STATUS_DOWN
<b>Message</b>	IPv4 status of the logical interface %s is DOWN
<b>Description</b>	Logical Interface configuration change is triggered.
<b>Log Module</b>	ifm
<b>Log Group</b>	config
<b>Severity</b>	info
<b>Recommended Actions</b>	Verify the IPv4 status for this logical interface.

<b>Log ID</b>	IFM_OPER_IFL_IPV6_STATUS_UP
<b>Message</b>	IPv6 status of the logical interface %s is UP
<b>Description</b>	IPv6 service is enabled on a logical interface.
<b>Log Module</b>	ifm
<b>Log Group</b>	config
<b>Severity</b>	info
<b>Recommended Actions</b>	Verify the IPv6 status for this logical interface.

<b>Log ID</b>	IFM_OPER_IFL_IPV6_STATUS_DOWN
<b>Message</b>	IPv6 status of the logical interface %s is DOWN
<b>Description</b>	IPv6 service is disabled on a logical interface.
<b>Log Module</b>	ifm
<b>Log Group</b>	config
<b>Severity</b>	info
<b>Recommended Actions</b>	Verify the IPv6 status for this logical interface.

<b>Log ID</b>	IFM_OPER_IFL_MPLS_STATUS_UP
---------------	-----------------------------

<b>Message</b>	The MPLS status of the logical interface %s is UP
<b>Description</b>	MPLS service is enabled on a logical interface.
<b>Log Module</b>	ifm
<b>Log Group</b>	config
<b>Severity</b>	info
<b>Recommended Actions</b>	Verify the status of MPLS for this logical interface.

<b>Log ID</b>	IFM_OPER_IFL_MPLS_STATUS_DOWN
<b>Message</b>	MPLS status of the logical interface %s is DOWN
<b>Description</b>	MPLS service is disabled on a logical interface.
<b>Log Module</b>	ifm
<b>Log Group</b>	config
<b>Severity</b>	info
<b>Recommended Actions</b>	Verify the status of MPLS for this logical interface.

<b>Log ID</b>	IFM_OPER_IFP_HOLDDOWN_START
<b>Message</b>	The holddown machinery for the physical interface %s is activated.
<b>Description</b>	Interface configuration or link event is triggered.
<b>Log Module</b>	ifm
<b>Log Group</b>	interface-events
<b>Severity</b>	info
<b>Recommended Action</b>	Check the physical connection for this particular port and its configuration.

<b>Log ID</b>	IFM_OPER_IFP_HOLDDOWN_STOP
<b>Message</b>	The holddown machinery for the physical interface %s is deactivated after %s carrier transitions.

<b>Description</b>	Interface configuration or link event is triggered.
<b>Log Module</b>	ifm
<b>Log Group</b>	interface-events
<b>Severity</b>	info
<b>Recommended Action</b>	Check the physical connection for this particular port and its configuration.

## IPoE Log Messages

<b>Log ID</b>	SUBSCRIBER_CREATED
<b>Message</b>	Subscriber %s created for %s.%s:%s %s
<b>Description</b>	IPoE subscriber has been created.
<b>Log Module</b>	ipoe
<b>Log Group</b>	subscriber
<b>Severity</b>	info
<b>Recommended Actions</b>	No action required.

<b>Log ID</b>	SUBSCRIBER_DELETED
<b>Message</b>	Subscriber %s deleted with terminate code %s
<b>Description</b>	IPoE subscriber has been deleted.
<b>Log Module</b>	ipoe
<b>Log Group</b>	subscriber
<b>Severity</b>	info
<b>Recommended Actions</b>	No action required.

<b>Log ID</b>	DHCP_BINDING_CREATED
<b>Message</b>	Subscriber %s DHCP binding created
<b>Description</b>	Subscriber DHCP binding (an entry into the binding table) has been created.

<b>Log Module</b>	ipoe
<b>Log Group</b>	dhcp
<b>Severity</b>	info
<b>Recommended Actions</b>	No action required.

<b>Log ID</b>	DHCP_BINDING_DELETED
<b>Message</b>	Subscriber %s DHCP lease expired
<b>Description</b>	Subscriber DHCP binding has been deleted.
<b>Log Module</b>	ipoe
<b>Log Group</b>	dhcp
<b>Severity</b>	info
<b>Recommended Actions</b>	No action required.

<b>Log ID</b>	DHCP_BINDING_EXPIRED
<b>Message</b>	Subscriber %s DHCP binding lease timer expired
<b>Description</b>	Subscriber DHCP binding lease expired.
<b>Log Module</b>	ipoe
<b>Log Group</b>	dhcp
<b>Severity</b>	info
<b>Recommended Actions</b>	No action required.

<b>Log ID</b>	DHCPV6_BINDING_CREATED
<b>Message</b>	Subscriber %s DHCPv6 binding created
<b>Description</b>	Subscriber DHCPv6 binding has been created.
<b>Log Module</b>	ipoe
<b>Log Group</b>	dhcp
<b>Severity</b>	info

<b>Recommended Actions</b>	No action required.
----------------------------	---------------------

<b>Log ID</b>	DHCPV6_BINDING_DELETED
<b>Message</b>	Subscriber %s DHCPv6 lease expired
<b>Description</b>	Subscriber DHCPv6 binding has been deleted.
<b>Log Module</b>	ipoe
<b>Log Group</b>	dhcp
<b>Severity</b>	info
<b>Recommended Actions</b>	No action required.

<b>Log ID</b>	DHCPV6_BINDING_EXPIRED
<b>Message</b>	Subscriber %s DHCPv6 binding lease timer expired
<b>Description</b>	The subscriber DHCPv6 binding lease expired.
<b>Log Module</b>	ipoe
<b>Log Group</b>	dhcp
<b>Severity</b>	info
<b>Recommended Actions</b>	No action required.

<b>Log ID</b>	SUBSCRIBER_DELETE_FAILED
<b>Message</b>	Subscriber %s deletion with terminate code %s failed
<b>Description</b>	IPoE subscriber deletion failure.
<b>Log Module</b>	ipoe
<b>Log Group</b>	subscriber
<b>Severity</b>	debug
<b>Recommended Actions</b>	No action required.

<b>Log ID</b>	SUBSCRIBER_RD_FAILURE
<b>Message</b>	Subscriber %s from redundancy session %s failed due to %s

<b>Description</b>	IPoE redundancy subscriber failure.
<b>Log Module</b>	ipoe
<b>Log Group</b>	redundancy
<b>Severity</b>	debug
<b>Recommended Actions</b>	Contact RtBrick Customer Support.

<b>Log ID</b>	DHCP_RELAY_TRAP
<b>Message</b>	Trap rule %s %s for DHCP relay
<b>Description</b>	Event of DHCP relay trap installation.
<b>Log Module</b>	ipoe
<b>Log Group</b>	dhcp-relay
<b>Severity</b>	info
<b>Recommended Actions</b>	No action required.

<b>Log ID</b>	DHCP_RELAY_DECODE_ERROR
<b>Message</b>	DHCP relay packet decode error on interface %s, error code: %s subcode: %s
<b>Description</b>	Failure in decoding the received DHCP relay packet.
<b>Log Module</b>	ipoe
<b>Log Group</b>	dhcp-relay
<b>Severity</b>	debug
<b>Recommended Actions</b>	No action required.

<b>Log ID</b>	DHCP_RELAY_SHM_DECODE
<b>Message</b>	DHCP relay packet shm validation error
<b>Description</b>	Failure in decoding the received DHCP relay packet.
<b>Log Module</b>	ipoe
<b>Log Group</b>	dhcp-relay

<b>Severity</b>	info
<b>Recommended Actions</b>	No action required.

<b>Log ID</b>	DHCP_RELAY_IP_UDP_DECODE
<b>Message</b>	DHCP relay packet IP header decode error on interface %s
<b>Description</b>	Failure in decoding the received DHCP relay packet.
<b>Log Module</b>	ipoe
<b>Log Group</b>	dhcp-relay
<b>Severity</b>	debug
<b>Recommended Actions</b>	No action required.

<b>Log ID</b>	DHCP_RELAY_GATEWAY_IP
<b>Message</b>	DHCP relay gateway IP address not configured for interface %s
<b>Description</b>	DHCP relay configuration is not available.
<b>Log Module</b>	ipoe
<b>Log Group</b>	dhcp-relay
<b>Severity</b>	debug
<b>Recommended Actions</b>	Configure the DHCP relay gateway IP address

<b>Log ID</b>	DHCP_RELAY_BINDING_ADD
<b>Message</b>	DHCP relay binding added for client %s on interface %s with gateway IP %s, client-ip %s and lease-time %s
<b>Description</b>	DHCP relay binding has been added.
<b>Log Module</b>	ipoe
<b>Log Group</b>	dhcp-relay
<b>Severity</b>	debug
<b>Recommended Actions</b>	No action required.



<b>Log ID</b>	DHCP_RELAY_BINDING_DELETE
<b>Message</b>	DHCP relay binding deleted for client %s on interface %s
<b>Description</b>	DHCP relay binding is deleted.
<b>Log Module</b>	ipoe
<b>Log Group</b>	dhcp-relay
<b>Severity</b>	debug
<b>Recommended Actions</b>	No action required.

<b>Log ID</b>	DHCP_RELAY_BINDING_MISSING
<b>Message</b>	DHCP relay binding missing for client %s, ignoring the packet from server
<b>Description</b>	DHCP relay binding is not available.
<b>Log Module</b>	ipoe
<b>Log Group</b>	dhcp-relay
<b>Severity</b>	debug
<b>Recommended Actions</b>	Contact RtBrick Customer Support.

<b>Log ID</b>	DHCP_RELAY_CONFIG
<b>Message</b>	DHCP relay configuration missing for interface %s
<b>Description</b>	DHCP relay configuration is not available.
<b>Log Module</b>	ipoe
<b>Log Group</b>	dhcp-relay
<b>Severity</b>	debug
<b>Recommended Actions</b>	Configure DHCP relay.

<b>Log ID</b>	DHCP_RELAY_SERVER_LIST_CONFIG
<b>Message</b>	DHCP relay server configuration missing on interface %s, dropping the DHCP packet %s
<b>Description</b>	DHCP server configuration is not available.

<b>Log Module</b>	ipoe
<b>Log Group</b>	dhcp-relay
<b>Severity</b>	debug
<b>Recommended Actions</b>	Verify the DHCP server configuration.

<b>Log ID</b>	DHCP_RELAY_SERVER_CONFIG
<b>Message</b>	DHCP relay server IP configuration missing on interface %s for DHCP server %s
<b>Description</b>	DHCP server configuration is missing.
<b>Log Module</b>	ipoe
<b>Log Group</b>	dhcp-relay
<b>Severity</b>	debug
<b>Recommended Actions</b>	Verify the DHCP relay configuration.

<b>Log ID</b>	DHCP_RELAY_SERVER_GET
<b>Message</b>	Unable to get DHCP relay server %s configuration on interface %s
<b>Description</b>	DHCP server configuration is missing.
<b>Log Module</b>	ipoe
<b>Log Group</b>	dhcp-relay
<b>Severity</b>	debug
<b>Recommended Actions</b>	Configure DHCP server.

<b>Log ID</b>	DHCP_RELAY_PACKET_CLIENT_RCV
<b>Message</b>	DHCP %s received from client on interface %s with MAC %s
<b>Description</b>	DHCP relay packet received from the client.
<b>Log Module</b>	ipoe
<b>Log Group</b>	dhcp-relay
<b>Severity</b>	debug

<b>Recommended Actions</b>	No action required.
----------------------------	---------------------

<b>Log ID</b>	DHCP_RELAY_PACKET_SERVER_RCV
<b>Message</b>	DHCP %s received from server %s for client on interface %s with MAC %s
<b>Description</b>	DHCP relay packet received from the server
<b>Log Module</b>	ipoe
<b>Log Group</b>	dhcp-relay
<b>Severity</b>	debug
<b>Recommended Actions</b>	No action required.

<b>Log ID</b>	DHCP_RELAY_PACKET_CLIENT_SENT
<b>Message</b>	DHCP %s from server %s sent to client on interface %s with MAC %s
<b>Description</b>	DHCP relay packet sent to the client.
<b>Log Module</b>	ipoe
<b>Log Group</b>	dhcp-relay
<b>Severity</b>	debug
<b>Recommended Actions</b>	No action required.

<b>Log ID</b>	DHCP_RELAY_PACKET_SERVER_SENT
<b>Message</b>	DHCP %s sent to server %s from client on interface %s with MAC %s
<b>Description</b>	DHCP relay packet sent to the server.
<b>Log Module</b>	ipoe
<b>Log Group</b>	dhcp-relay
<b>Severity</b>	debug
<b>Recommended Actions</b>	No action required.

<b>Log ID</b>	DHCP_RELAY_PACKET_CLIENT_RCV_INVALID
<b>Message</b>	Invalid DHCP %s received from client on interface %s with MAC %s
<b>Description</b>	DHCP relay packet received from the client.
<b>Log Module</b>	ipoe
<b>Log Group</b>	dhcp-relay
<b>Severity</b>	debug
<b>Recommended Actions</b>	No action required.

<b>Log ID</b>	DHCP_RELAY_PACKET_SERVER_RCV_INVALID
<b>Message</b>	Invalid DHCP %s received from server %s
<b>Description</b>	DHCP relay packet received from the server.
<b>Log Module</b>	ipoe
<b>Log Group</b>	dhcp-relay
<b>Severity</b>	debug
<b>Recommended Actions</b>	No action required.

<b>Log ID</b>	DHCP_RELAY_PROXY_SERVER
<b>Message</b>	Selecting the server %s for the client on interface %s in proxy mode
<b>Description</b>	DHCP relay proxy server has been selected.
<b>Log Module</b>	ipoe
<b>Log Group</b>	dhcp-relay
<b>Severity</b>	debug
<b>Recommended Actions</b>	No action required.

<b>Log ID</b>	DHCP_RELAY_PROXY_IGNORE_SERVER_PACKET
<b>Message</b>	Ignoring packet %s from server %s as the selected server is %s

<b>Description</b>	DHCP relay proxy packet ignored from the server.
<b>Log Module</b>	ipoe
<b>Log Group</b>	dhcp-relay
<b>Severity</b>	debug
<b>Recommended Actions</b>	No action required.

<b>Log ID</b>	DHCP_RELAY_ENCODE_ERROR
<b>Message</b>	Error in encoding DHCP %s packet with client interface %s with MAC %s
<b>Description</b>	DHCP relay encode error.
<b>Log Module</b>	ipoe
<b>Log Group</b>	dhcp-relay
<b>Severity</b>	debug
<b>Recommended Actions</b>	No action required.

<b>Log ID</b>	DHCP_RELAY_PROXY_NO_SERVER
<b>Message</b>	Server identifier missing in DHCP relay binding, dropping the DHCP %s packet from client interface %s with MAC %s
<b>Description</b>	No DHCP relay proxy server in binding.
<b>Log Module</b>	ipoe
<b>Log Group</b>	dhcp-relay
<b>Severity</b>	debug
<b>Recommended Actions</b>	No action required.

<b>Log ID</b>	DHCP_RELAY_INVALID_DST_IP
<b>Message</b>	Invalid destination IP, dropping the DHCP %s packet from client interface %s with MAC %s
<b>Description</b>	DHCP relay proxy server in binding is not available.
<b>Log Module</b>	ipoe

<b>Log Group</b>	dhcp-relay
<b>Severity</b>	debug
<b>Recommended Actions</b>	No action required.

## IS-IS Log Messages

<b>Log ID</b>	ISIS_INSTANCE_OVERLOAD
<b>Message</b>	ISIS instance %s, level %s, %s, overload state
<b>Description</b>	ISIS instance overload enters or exits.
<b>Log Module</b>	isis
<b>Log Group</b>	instance
<b>Severity</b>	Alert
<b>Recommended Actions</b>	No action required.

<b>Log ID</b>	ISIS_NEIGHBOR_DISCOVERY
<b>Message</b>	ISIS neighbor %s, discovered, interface %s, instance %s
<b>Description</b>	An ISIS neighbor is discovered.
<b>Log Module</b>	isis
<b>Log Group</b>	neighbor
<b>Severity</b>	Alert
<b>Recommended Actions</b>	No action required.

<b>Log ID</b>	ISIS_NEIGHBOR_STATE_CHANGE
<b>Message</b>	ISIS neighbor %s, interface %s, instance %s, changed state from %s, to %s, reason %s
<b>Description</b>	Changes in the ISIS neighbor FSM state.
<b>Log Module</b>	isis
<b>Log Group</b>	neighbor
<b>Severity</b>	Alert

<b>Recommended Actions</b>	No action required.
----------------------------	---------------------

<b>Log ID</b>	ISIS_NEIGHBOR_DELETED
<b>Message</b>	ISIS neighbor %s, deleted, interface %s, instance %s
<b>Description</b>	An ISIS neighbor is deleted.
<b>Log Module</b>	isis
<b>Log Group</b>	neighbor
<b>Severity</b>	Info
<b>Recommended Actions</b>	No action is required.

<b>Log ID</b>	ISIS_IFL_CHANGE
<b>Message</b>	Interface %s, instance %s, received event %s, operational state %s, admin state %s, ipv4 status %s, ipv6 status %s
<b>Description</b>	Event of ISIS enabled interface status change.
<b>Log Module</b>	isis
<b>Log Group</b>	interface
<b>Severity</b>	Info
<b>Recommended Actions</b>	No action required.

<b>Log ID</b>	ISIS_IFA_CHANGE
<b>Message</b>	Interface %s, instance %s, received %s, for address %s
<b>Description</b>	An ISIS-enabled interface address event.
<b>Log Module</b>	isis
<b>Log Group</b>	interface
<b>Severity</b>	Info
<b>Recommended Actions</b>	No action required.

<b>Log ID</b>	ISIS_PDU_DECODE_FAIL
---------------	----------------------

<b>Message</b>	ISIS PDU %s, decode failure received in interface %s, instance %s, level %s, reason %s
<b>Description</b>	ISIS PDU decoding failure.
<b>Log Module</b>	isis
<b>Log Group</b>	message
<b>Severity</b>	Alert
<b>Recommended Actions</b>	Capture and verify the ISIS packets. Contact RtBrick Customer Support.

<b>Log ID</b>	ISIS_AUTHENTICATION_FAIL
<b>Message</b>	Authentication failure for PDU %s, interface %s, instance %s, level %s
<b>Description</b>	ISIS Authentication failure.
<b>Log Module</b>	isis
<b>Log Group</b>	message
<b>Severity</b>	Alert
<b>Recommended Actions</b>	Verify if the authentication type, key, and password are matching at both ends.

<b>Log ID</b>	ISIS_LSP_FLOOD_FILTER_BLOCK
<b>Message</b>	LSP flooding is blocked for neighbor %s, in interface %s, instance %s, level %s, for lsp-id %s
<b>Description</b>	Event of ISIS flood filter block.
<b>Log Module</b>	isis
<b>Log Group</b>	message
<b>Severity</b>	Debug
<b>Recommended Actions</b>	No action required.

<b>Log ID</b>	ISIS_SPF_COMPUTATION
<b>Message</b>	Dijkstra's Shortest Path First algorithm triggered in instance %s, level %s. Reason %s



<b>Description</b>	The Dijkstra's Shortest Path First algorithm triggered
<b>Log Module</b>	isis
<b>Log Group</b>	spf
<b>Severity</b>	Info
<b>Recommended Actions</b>	No action required.

<b>Log ID</b>	ISIS_SPF_COMPUTATION_LSP
<b>Message</b>	Dijkstra's Shortest Path First algorithm triggered in instance %s, level %s. Reason LSP %s, received
<b>Description</b>	The received LSP has triggered Dijkstra's Shortest Path First algorithm.
<b>Log Module</b>	isis
<b>Log Group</b>	spf
<b>Severity</b>	Info
<b>Recommended Actions</b>	No action required.

<b>Log ID</b>	ISIS_ORIGINATE_SELF_LSP
<b>Message</b>	Self lsp is originate in instance %s, level %s, lsp id %s, sequence number %s
<b>Description</b>	LSP originated.
<b>Log Module</b>	isis
<b>Log Group</b>	lsp
<b>Severity</b>	Info
<b>Recommended Actions</b>	No action is required.

<b>Log ID</b>	ISIS_ORIGINATE_LSP_PURGE
<b>Message</b>	Purge lsp is originated in instance %s, level %s, lsp id %s, sequence number %s
<b>Description</b>	Purge LSP originated.

<b>Log Module</b>	isis
<b>Log Group</b>	lsp
<b>Severity</b>	Info
<b>Recommended Actions</b>	No action required.

<b>Log ID</b>	ISIS_IPV4_PREFIX_ADD
<b>Message</b>	Add %s, metric %s, source %s, preference %s, instance %s, topology %s
<b>Description</b>	IPv4 prefix is added.
<b>Log Module</b>	isis
<b>Log Group</b>	route
<b>Severity</b>	Debug
<b>Recommended Actions</b>	No action required.

<b>Log ID</b>	ISIS_IPV6_PREFIX_ADD
<b>Message</b>	Add %s, metric %s, source %s, preference %s, instance %s, topology %s
<b>Description</b>	IPv6 prefix is added.
<b>Log Module</b>	isis
<b>Log Group</b>	route
<b>Severity</b>	Debug
<b>Recommended Actions</b>	No action required.

<b>Log ID</b>	ISIS_MPLS_LABEL_ADD
<b>Message</b>	Add mpls label %s, source %s, preference %s, instance %s, topology %s
<b>Description</b>	MPLS prefix is added.
<b>Log Module</b>	isis
<b>Log Group</b>	route

<b>Severity</b>	Debug
<b>Recommended Actions</b>	No action required.

<b>Log ID</b>	ISIS_IPV4_PREFIX_DELETE
<b>Message</b>	Delete %s, instance %s, topology %s
<b>Description</b>	IPv4 prefix is deleted.
<b>Log Module</b>	isis
<b>Log Group</b>	route
<b>Severity</b>	Debug
<b>Recommended Actions</b>	No action required.

<b>Log ID</b>	ISIS_IPV6_PREFIX_DELETE
<b>Message</b>	Delete %s, instance %s, topology %s
<b>Description</b>	IPv6 prefix is deleted.
<b>Log Module</b>	isis
<b>Log Group</b>	route
<b>Severity</b>	Debug
<b>Recommended Actions</b>	No action required.

<b>Log ID</b>	ISIS_MPLS_LABEL_DELETE
<b>Message</b>	Delete mpls-label %s, instance %s, topology %s
<b>Description</b>	MPLS prefix deletion log
<b>Log Module</b>	isis
<b>Log Group</b>	route
<b>Severity</b>	Debug
<b>Recommended Actions</b>	Contact Rtbrick customer support

## LDP Log Messages

<b>Log ID</b>	LDP_SESSION_CREATED
<b>Message</b>	LDP Session created, peer %s, instance %s
<b>Description</b>	LDP has formed a new session.
<b>Log Module</b>	ldp
<b>Log Group</b>	peer
<b>Severity</b>	debug
<b>Recommended Actions</b>	None Required.

<b>Log ID</b>	LDP_SESSION_DELETED
<b>Message</b>	LDP Session deleted, peer %s, instance %s
<b>Description</b>	LDP session is deleted.
<b>Log Module</b>	ldp
<b>Log Group</b>	peer
<b>Severity</b>	debug
<b>Recommended Actions</b>	Run the <code>show ldp session detail</code> command and check the "Reason" attribute for information.

<b>Log ID</b>	LDP_TCP_STATE_CHNG
<b>Message</b>	LDP TCP state changed from "%s" to "%s" due to event "%s", peer %s, instance %s
<b>Description</b>	LDP TCP state has changed.
<b>Log Module</b>	ldp
<b>Log Group</b>	peer
<b>Severity</b>	debug
<b>Recommended Actions</b>	None Required.

<b>Log ID</b>	LDP_SESSION_STATE_CHNG
---------------	------------------------

<b>Message</b>	LDP Session state changed from "%s" to "%s" due to event "%s", peer %s, instance %s
<b>Description</b>	LDP session state has changed.
<b>Log Module</b>	ldp
<b>Log Group</b>	peer
<b>Severity</b>	debug
<b>Recommended Actions</b>	None Required.

<b>Log ID</b>	LDP_MSG_ADDR_OUT
<b>Message</b>	LDP Address message sent for prefix %s, peer %s, instance %s
<b>Description</b>	LDP address message is sent.
<b>Log Module</b>	ldp
<b>Log Group</b>	peer
<b>Severity</b>	debug
<b>Recommended Actions</b>	None Required.

<b>Log ID</b>	LDP_MSG_ADDR_IN
<b>Message</b>	LDP Address message received for prefix %s, peer %s, instance %s
<b>Description</b>	LDP address message is received.
<b>Log Module</b>	ldp
<b>Log Group</b>	peer
<b>Severity</b>	debug
<b>Recommended Actions</b>	None Required.

<b>Log ID</b>	LDP_MSG_ADDR_WITHDRAW_OUT
<b>Message</b>	LDP Address withdraw message sent for prefix %s, peer %s, instance %s

<b>Description</b>	LDP address withdrawal message is sent.
<b>Log Module</b>	ldp
<b>Log Group</b>	peer
<b>Severity</b>	debug
<b>Recommended Actions</b>	None Required.

<b>Log ID</b>	LDP_MSG_ADDR_WITHDRAW_IN
<b>Message</b>	LDP Address withdraw message received for prefix %s, peer %s, instance %s
<b>Description</b>	LDP address withdrawal message is received.
<b>Log Module</b>	ldp
<b>Log Group</b>	peer
<b>Severity</b>	debug
<b>Recommended Actions</b>	None Required.

<b>Log ID</b>	LDP_MSG_LABEL_MAP_OUT
<b>Message</b>	LDP label mapping message sent for prefix %s with label-%s, peer %s, instance %s
<b>Description</b>	LDP mapping message is sent.
<b>Log Module</b>	ldp
<b>Log Group</b>	peer
<b>Severity</b>	debug
<b>Recommended Actions</b>	None Required.

<b>Log ID</b>	LDP_MSG_LABEL_MAP_IN
<b>Message</b>	LDP label mapping message received for prefix %s with label-%s, peer %s, instance %s
<b>Description</b>	LDP mapping is received.
<b>Log Module</b>	ldp

<b>Log Group</b>	peer
<b>Severity</b>	debug
<b>Recommended Actions</b>	None Required.

<b>Log ID</b>	LDP_MSG_LABEL_WITHDRAW_OUT
<b>Message</b>	LDP label withdraw message sent for prefix %s with label-%s, peer %s, instance %s
<b>Description</b>	LDP mapping withdrawal message is sent.
<b>Log Module</b>	ldp
<b>Log Group</b>	peer
<b>Severity</b>	debug
<b>Recommended Actions</b>	None Required.

<b>Log ID</b>	LDP_MSG_LABEL_WITHDRAW_IN
<b>Message</b>	LDP label withdraw message received for prefix %s with label-%s, peer %s, instance %s
<b>Description</b>	LDP mapping withdrawal message is received.
<b>Log Module</b>	ldp
<b>Log Group</b>	peer
<b>Severity</b>	debug
<b>Recommended Actions</b>	None Required.

<b>Log ID</b>	LDP_MSG_LABEL_REQ_REPLY_OUT
<b>Message</b>	LDP label request message reply for prefix %s sent with label-%s, peer %s, instance %s
<b>Description</b>	LDP request reply message is sent.
<b>Log Module</b>	ldp
<b>Log Group</b>	peer
<b>Severity</b>	debug

<b>Recommended Actions</b>	None Required.
----------------------------	----------------

<b>Log ID</b>	LDP_MSG_LABEL_REQ_IN
<b>Message</b>	LDP label request message received, prefix %s, peer %s, instance %s
<b>Description</b>	LDP request message is received.
<b>Log Module</b>	ldp
<b>Log Group</b>	peer
<b>Severity</b>	debug
<b>Recommended Actions</b>	None Required.

<b>Log ID</b>	LDP_MSG_LABEL_REL_OUT
<b>Message</b>	LDP label release message sent, prefix %s, label-%s, peer %s, instance %s
<b>Description</b>	LDP release message is sent.
<b>Log Module</b>	ldp
<b>Log Group</b>	peer
<b>Severity</b>	debug
<b>Recommended Actions</b>	None Required.

<b>Log ID</b>	LDP_MSG_LABEL_REL_IN
<b>Message</b>	LDP label release message received, prefix %s, label-%s, peer %s, instance %s
<b>Description</b>	LDP release message is received.
<b>Log Module</b>	ldp
<b>Log Group</b>	peer
<b>Severity</b>	debug
<b>Recommended Actions</b>	None Required.



<b>Log ID</b>	LDP_ADD_TO_FIB
<b>Message</b>	LDP route added to FIB, prefix %s, label-%s, instance %s
<b>Description</b>	LDP has been added to FIB.
<b>Log Module</b>	ldp
<b>Log Group</b>	peer
<b>Severity</b>	debug
<b>Recommended Actions</b>	None Required.

<b>Log ID</b>	LDP_DEL_FROM_FIB
<b>Message</b>	LDP route deleted from FIB, prefix %s, label-%s, instance %s
<b>Description</b>	LDP is deleted from FIB.
<b>Log Module</b>	ldp
<b>Log Group</b>	peer
<b>Severity</b>	debug
<b>Recommended Actions</b>	None Required.

<b>Log ID</b>	LDP_NBR_CREATED
<b>Message</b>	LDP Neighbour created, peer %s, interface %s, instance %s
<b>Description</b>	LDP has formed a new neighbor
<b>Log Module</b>	ldp
<b>Log Group</b>	adjacency
<b>Severity</b>	INFO
<b>Recommended Actions</b>	None Required.

<b>Log ID</b>	LDP_NBR_DELETED
<b>Message</b>	LDP Neighbour deleted, peer %s, interface %s, instance %s
<b>Description</b>	LDP neighbor is removed.
<b>Log Module</b>	ldp

<b>Log Group</b>	adjacency
<b>Severity</b>	INFO
<b>Recommended Actions</b>	Configure the neighbor router again for establishing neighborhood and sending hello packets.

<b>Log ID</b>	LDP_NOTIFICATION_IN
<b>Message</b>	LDP Notification received, peer %s, instance %s, reason %s
<b>Description</b>	LDP has received notification messages. There are basically two types of notification, one is advisory and the other is fatal. In case a fatal notification is received, the session will be reset.
<b>Log Module</b>	ldp
<b>Log Group</b>	notification
<b>Severity</b>	INFO
<b>Recommended Actions</b>	If the peer is reset, run the <code>show ldp session detail</code> command and check the "Reason" attribute.

<b>Log ID</b>	LDP_NOTIFICATION_OUT
<b>Message</b>	LDP Notification sent, peer %s, instance %s, reason %s
<b>Description</b>	LDP has sent out notification messages to the peer.
<b>Log Module</b>	ldp
<b>Log Group</b>	notification
<b>Severity</b>	INFO
<b>Recommended Actions</b>	If peer is reset, run the <code>show ldp session detail</code> command and check the "Reason" attribute.

<b>Log ID</b>	LDP_SESSION_STATE
<b>Message</b>	LDP session state changed to %s, peer %s, instance %s
<b>Description</b>	LDP session state has changed
<b>Log Module</b>	ldp
<b>Log Group</b>	peer
<b>Severity</b>	INFO

<b>Recommended Actions</b>	None Required.
----------------------------	----------------

## License Log Messages

<b>Log ID</b>	LICENSE_INTERNAL_NULL_STRING
<b>Message</b>	NULL license string passed to license verification API
<b>Description</b>	Invalid parameters passed for the license verification API.
<b>Log Module</b>	license
<b>Log Group</b>	internal
<b>Severity</b>	ERROR
<b>Recommended Actions</b>	Internal error. Contact RtBrick customer support

<b>Log ID</b>	LICENSE_INTERNAL_INVALID_STRING
<b>Message</b>	Invalid license string passed to license verification API
<b>Description</b>	Invalid parameters passed for the license verification API.
<b>Log Module</b>	license
<b>Log Group</b>	internal
<b>Severity</b>	INFO
<b>Recommended Actions</b>	Internal error. Contact RtBrick customer support

<b>Log ID</b>	LICENSE_FILE_READ_FAILURE
<b>Message</b>	Unable to read license string from license file %s
<b>Description</b>	License file read failure.
<b>Log Module</b>	license
<b>Log Group</b>	internal
<b>Severity</b>	ERROR
<b>Recommended Actions</b>	Internal error. Contact RtBrick customer support.

<b>Log ID</b>	LICENSE_FILE_OPEN_FAILURE
<b>Message</b>	Unable to open from license file %s
<b>Description</b>	Unable to open the license file.
<b>Log Module</b>	license
<b>Log Group</b>	internal
<b>Severity</b>	ERROR
<b>Recommended Actions</b>	Internal error. Contact RtBrick customer support

<b>Log ID</b>	LICENSE_STRING_ALLOCATION_FAILURE
<b>Message</b>	Unable to allocate %s bytes for license string
<b>Description</b>	Memory allocation failure
<b>Log Module</b>	license
<b>Log Group</b>	internal
<b>Severity</b>	ERROR
<b>Recommended Actions</b>	Contact RtBrick customer support

<b>Log ID</b>	LICENSE_INVALID_STRING_IN_FILE
<b>Message</b>	Invalid license string present in license file %s
<b>Description</b>	Invalid license installed
<b>Log Module</b>	license
<b>Log Group</b>	internal
<b>Severity</b>	ERROR
<b>Recommended Actions</b>	Contact RtBrick customer support

<b>Log ID</b>	LICENSE_INVALID_CONTENT
<b>Message</b>	Invalid license content in file %s
<b>Description</b>	Invalid license content
<b>Log Module</b>	license

<b>Log Group</b>	internal
<b>Severity</b>	ERROR
<b>Recommended Actions</b>	Contact RtBrick customer support

<b>Log ID</b>	LICENSE_DIRECTORY_OPEN_FAILURE
<b>Message</b>	Unable to open license directory
<b>Description</b>	License directory open failure.
<b>Log Module</b>	license
<b>Log Group</b>	internal
<b>Severity</b>	ERROR
<b>Recommended Actions</b>	Contact Rtbrick customer support

<b>Log ID</b>	LICENSE_START_DATE_MISSING
<b>Message</b>	License doesn't have a start date
<b>Description</b>	License file did not have a start date.
<b>Log Module</b>	license
<b>Log Group</b>	internal
<b>Severity</b>	ERROR
<b>Recommended Actions</b>	Start date is missing in the license file. Obtain a valid license.

<b>Log ID</b>	LICENSE_END_DATE_MISSING
<b>Message</b>	License doesn't have an end date
<b>Description</b>	License file did not have an end date.
<b>Log Module</b>	license
<b>Log Group</b>	internal
<b>Severity</b>	ERROR
<b>Recommended Actions</b>	End date is missing in the license file. Obtain a valid license.

<b>Log ID</b>	LICENSE_DIRECTORY_CLOSE_FAILURE
<b>Message</b>	Unable to close the license directory.
<b>Description</b>	Unable to close the license directory.
<b>Log Module</b>	license
<b>Log Group</b>	internal
<b>Severity</b>	ERROR
<b>Recommended Actions</b>	Contact RtBrick customer support

<b>Log ID</b>	LICENSE_HOSTCONFD_CONNECTION_DOWN
<b>Message</b>	License installation delayed due to <b>hostconfd</b> connection down
<b>Description</b>	License installation has been delayed due to the <b>hostconfd</b> connectivity issue.
<b>Log Module</b>	license
<b>Log Group</b>	internal
<b>Severity</b>	INFO
<b>Recommended Actions</b>	Contact RtBrick customer support

<b>Log ID</b>	LICENSE_INIT_FAILED
<b>Message</b>	License initialization failed.
<b>Description</b>	License initialization has failed.
<b>Log Module</b>	license
<b>Log Group</b>	internal
<b>Severity</b>	ERROR
<b>Recommended Actions</b>	Contact RtBrick customer support

<b>Log ID</b>	LICENSE_TABLE_NOT_PRESENT
<b>Message</b>	License table ( <b>global.rtbrick.license</b> ) is not present
<b>Description</b>	The license table <b>global.rtbrick.license</b> is not present.

<b>Log Module</b>	license
<b>Log Group</b>	internal
<b>Severity</b>	ERROR
<b>Recommended Actions</b>	Contact RtBrick customer support

<b>Log ID</b>	LICENSE_SECONDARY_VALIDATION_COMPROMISED
<b>Message</b>	License table ( <a href="#">global.rtbrick.license</a> ) is not present
<b>Description</b>	The license table <a href="#">global.rtbrick.license</a> is not present.
<b>Log Module</b>	license
<b>Log Group</b>	internal
<b>Severity</b>	ERROR
<b>Recommended Actions</b>	Contact RtBrick customer support

<b>Log ID</b>	LICENSE_STATS_TABLE_NOT_PRESENT
<b>Message</b>	License stats table ( <a href="#">local.rtbrick.license.stats</a> ) is not present
<b>Description</b>	The license stats table <a href="#">local.rtbrick.license.stats</a> is not present.
<b>Log Module</b>	license
<b>Log Group</b>	internal
<b>Severity</b>	ERROR
<b>Recommended Actions</b>	Contact Rtbrick customer support

<b>Log ID</b>	LICENSE_CONFIG_TABLE_CREATE_FAILED
<b>Message</b>	License config table ( <a href="#">local.rtbrick.license.config</a> ) is not present
<b>Description</b>	License stats table <a href="#">local.rtbrick.license.config</a> is not present.
<b>Log Module</b>	license
<b>Log Group</b>	internal
<b>Severity</b>	ERROR

<b>Recommended Actions</b>	Contact RtBrick customer support
----------------------------	----------------------------------

<b>Log ID</b>	LICENSE_TRAIL_PERIOD_EXPIRY
<b>Message</b>	The software trial period has ended, install a license.
<b>Description</b>	The software trial period has ended.
<b>Log Module</b>	license
<b>Log Group</b>	operational
<b>Severity</b>	CRITICAL
<b>Recommended Actions</b>	Install a new license.

<b>Log ID</b>	LICENSE_EXPIRY_WARNING
<b>Message</b>	The current license will expire by %s, install a new license
<b>Description</b>	The current license is about to expire.
<b>Log Module</b>	license
<b>Log Group</b>	operational
<b>Severity</b>	WARNING
<b>Recommended Actions</b>	Install a new license.

<b>Log ID</b>	LICENSE_EXPIRY_ERROR
<b>Message</b>	The current license will expire by %s, please install a new license
<b>Description</b>	The current license is about to expire.
<b>Log Module</b>	license
<b>Log Group</b>	operational
<b>Severity</b>	ERROR
<b>Recommended Actions</b>	Install a new license.

<b>Log ID</b>	LICENSE_EXPIRY_CRITICAL
---------------	-------------------------



<b>Message</b>	The current license has expired, install a new license
<b>Description</b>	The current license has expired.
<b>Log Module</b>	license
<b>Log Group</b>	operational
<b>Severity</b>	CRITICAL
<b>Recommended Actions</b>	Install a new license.

## Policy Log Messages

<b>Log ID</b>	POLICY_LOG_CODE_GEN_STATUS_FAILED
<b>Message</b>	Policy [%s]: Code Generation Error Reason [%s]
<b>Description</b>	Policy code generation has failed.
<b>Log Module</b>	policy
<b>Log Group</b>	Generation
<b>Severity</b>	ERROR
<b>Recommended Actions</b>	Delete the old policy library and if the problem still persists, contact RtBrick customer support.

<b>Log ID</b>	POLICY_LOG_CODE_GEN_STATUS_SUCCESS
<b>Message</b>	Policy [%s]: Code Generation Status: [%s]
<b>Description</b>	Policy code generation status
<b>Log Module</b>	policy
<b>Log Group</b>	Generation
<b>Severity</b>	INFO
<b>Recommended Actions</b>	No action required.

## PPPoE Log Messages

<b>Log ID</b>	PPPOE_CONFIG_NOT_FOUND
---------------	------------------------

<b>Message</b>	No matching configuration found for PPPoE discovery on interface %s, MAC %s, S-Tag %s, C-Tag %s
<b>Description</b>	Received PPPoE discovery packet without a matching configuration.
<b>Log Module</b>	pppoe
<b>Log Group</b>	config
<b>Severity</b>	info
<b>Recommended Actions</b>	Verify the access interface configuration.

<b>Log ID</b>	PPPOE_SUBSCRIBER_ID_GET_FAILED
<b>Message</b>	PPPoE session subscriber-id get failed on interface %s, MAC %s, PPPoE session-id %s, S-Tag %s, C-Tag %s
<b>Description</b>	Failure in assigning the subscriber identifier to the PPPoE session.
<b>Log Module</b>	pppoe
<b>Log Group</b>	subscriber
<b>Severity</b>	info
<b>Recommended Actions</b>	No action required.

<b>Log ID</b>	PPPOE_FSM_STATE_CHANGE
<b>Message</b>	%s session for subscriber-id %s changed state from %s to %s for input %s, action %s
<b>Description</b>	PPP FSM state has changed.
<b>Log Module</b>	pppoe
<b>Log Group</b>	ppp
<b>Severity</b>	info
<b>Recommended Actions</b>	No action required.

<b>Log ID</b>	PPPOE_PPP_SEND_ERROR
---------------	----------------------

<b>Message</b>	Failed to encode and send PPP packet on interface %s, subscriber-id %s
<b>Description</b>	Failed to encode and send PPP packet.
<b>Log Module</b>	pppoe
<b>Log Group</b>	ppp
<b>Severity</b>	info
<b>Recommended Actions</b>	No action required.

<b>Log ID</b>	PPPOE_LCP_WRONG_ECHO_MAGIC
<b>Message</b>	LCP ECHO received on interface %s, subscriber-id %s with wrong magic number %s, expected %s
<b>Description</b>	PPP LCP echo request/reply received with a wrong magic number.
<b>Log Module</b>	pppoe
<b>Log Group</b>	ppp
<b>Severity</b>	info
<b>Recommended Actions</b>	Restart the subscriber.

<b>Log ID</b>	PPPOE_LCP_WRONG_ECHO_REPLY_ID
<b>Message</b>	LCP ECHO reply received on interface %s, subscriber-id %s with wrong identifier %s, expected %s
<b>Description</b>	PPP LCP echo reply received with a wrong identifier.
<b>Log Module</b>	pppoe
<b>Log Group</b>	ppp
<b>Severity</b>	info
<b>Recommended Actions</b>	Restart the subscriber.

<b>Log ID</b>	PPPOE_LCP_RCV_PROTO_REJECT
---------------	----------------------------

<b>Message</b>	PPP protocol reject received on interface %s, subscriber-id %s protocol %s
<b>Description</b>	PPP protocol 'reject' has been received.
<b>Log Module</b>	pppoe
<b>Log Group</b>	ppp
<b>Severity</b>	info
<b>Recommended Actions</b>	No action required.

<b>Log ID</b>	PPPOE_PROTO_DECODE_ERROR
<b>Message</b>	%s packet decode error on interface %s, MAC %s, session-id %s, subscriber-id %s with remaining packet length %s
<b>Description</b>	Failed to decode the received PPPoE PPP packet.
<b>Log Module</b>	pppoe
<b>Log Group</b>	ppp
<b>Severity</b>	info
<b>Recommended Actions</b>	No action required.

<b>Log ID</b>	PPPOE_LCP_RCV_WRONG_ID
<b>Message</b>	LCP %s received on interface %s, subscriber-id %s with identifier %s, expected %s
<b>Description</b>	Received PPP LCP response with a wrong identifier.
<b>Log Module</b>	pppoe
<b>Log Group</b>	ppp
<b>Severity</b>	info
<b>Recommended Actions</b>	No action required.

<b>Log ID</b>	PPPOE_LCP_RCV_MRU
<b>Message</b>	LCP %s received on interface %s, subscriber-id %s with received MRU %s, local MRU %s

<b>Description</b>	PPP LCP response with wrong or suggested MRU received.
<b>Log Module</b>	pppoe
<b>Log Group</b>	ppp
<b>Severity</b>	info
<b>Recommended Actions</b>	No action required.

<b>Log ID</b>	PPPOE_LCP_RCV_MAGIC
<b>Message</b>	LCP %s received on interface %s, subscriber-id %s with received magic %s, local magic %s
<b>Description</b>	PPP LCP response with wrong or suggested magic number received.
<b>Log Module</b>	pppoe
<b>Log Group</b>	ppp
<b>Severity</b>	info
<b>Recommended Actions</b>	Restart the subscriber.

<b>Log ID</b>	PPPOE_LCP_RCV_AUTH
<b>Message</b>	LCP %s received on interface %s, subscriber-id %s with wrong authentication protocol %s, expected %s
<b>Description</b>	PPP LCP response with wrong or suggested auth protocol received.
<b>Log Module</b>	pppoe
<b>Log Group</b>	ppp
<b>Severity</b>	info
<b>Recommended Actions</b>	Restart the subscriber.

<b>Log ID</b>	PPPOE_PPP_RCV_ERROR
<b>Message</b>	%s receive error %s on interface %s, MAC %s, session-id %s, subscriber-id %s

<b>Description</b>	Error in receiving PPP.
<b>Log Module</b>	pppoe
<b>Log Group</b>	ppp
<b>Severity</b>	info
<b>Recommended Actions</b>	Restart the subscriber.

<b>Log ID</b>	PPPOE_PROTO_MAX_RETRANSMISSION
<b>Message</b>	Maximum %s retransmission count on interface %s, subscriber-id %s, retransmit count %s
<b>Description</b>	PPPoE PPP retransmission has exceeded.
<b>Log Module</b>	pppoe
<b>Log Group</b>	ppp
<b>Severity</b>	info
<b>Recommended Actions</b>	Restart the subscriber.

<b>Log ID</b>	PPPOE_AUTH_REJECT
<b>Message</b>	Authentication rejected on interface %s, subscriber-id %s with user %s
<b>Description</b>	PPPoE PPP authentication has been rejected.
<b>Log Module</b>	pppoe
<b>Log Group</b>	ppp
<b>Severity</b>	info
<b>Recommended Actions</b>	Verify the subscriber username and password.

<b>Log ID</b>	PPPOE_NO_SOURCE_IP
<b>Message</b>	%s source IP address not found on interface %s, subscriber-id %s
<b>Description</b>	Source IP address is missing to set up PPPoE PPP session.
<b>Log Module</b>	pppoe

<b>Log Group</b>	ppp
<b>Severity</b>	info
<b>Recommended Actions</b>	Configure source IP for the source IFL.

<b>Log ID</b>	PPPOE_PROTO_RECEIVE_ERROR
<b>Message</b>	Protocol receive error %s on interface %s, MAC %s, session-id %s, subscriber-id %s
<b>Description</b>	Error in receiving PPPoE PPP protocol.
<b>Log Module</b>	pppoe
<b>Log Group</b>	ppp
<b>Severity</b>	info
<b>Recommended Actions</b>	No action required.

<b>Log ID</b>	PPPOE_PROTO_RCV_ID_WARNING
<b>Message</b>	%s %s received on interface %s, subscriber-id %s with wrong identifier %s, expected %s
<b>Description</b>	PPP NCP response received with a wrong identifier.
<b>Log Module</b>	pppoe
<b>Log Group</b>	ppp
<b>Severity</b>	info
<b>Recommended Actions</b>	No action required.

<b>Log ID</b>	PPPOE_IPCP_RECEIVE_WRONG_IP
<b>Message</b>	IPCP %s received on interface %s, subscriber-id %s with address %s, expected %s
<b>Description</b>	PPP IPCP reply received with wrong address.
<b>Log Module</b>	pppoe
<b>Log Group</b>	ppp
<b>Severity</b>	info

<b>Recommended Actions</b>	No action required.
----------------------------	---------------------

<b>Log ID</b>	PPPOE_IPV6_CHECKSUM_ERROR
<b>Message</b>	PPPoE IPv6 packet decode checksum error on interface %s, subscriber-id %s
<b>Description</b>	Failed to decode the received PPPoE PPP packet with a wrong IPv6 checksum (UDP or ICMPv6) value.
<b>Log Module</b>	pppoe
<b>Log Group</b>	ppp
<b>Severity</b>	info
<b>Recommended Actions</b>	No action required.

<b>Log ID</b>	PPPOE_DECODE_ERROR
<b>Message</b>	Error decoding received PPPoE packet on interface %s, MAC %s
<b>Description</b>	Failed to decode the PPPoE ether type or VLAN.
<b>Log Module</b>	pppoe
<b>Log Group</b>	pppoe
<b>Severity</b>	info
<b>Recommended Actions</b>	No action required.

<b>Log ID</b>	PPPOE_DECODE_ERROR_WITH_VLAN
<b>Message</b>	Error decoding received PPPoE packet on interface %s, MAC %s, S-Tag %s, C-Tag %s
<b>Description</b>	Failed to decode the PPPoE discovery packet.
<b>Log Module</b>	pppoe
<b>Log Group</b>	pppoe
<b>Severity</b>	info



<b>Recommended Actions</b>	Verify the options and VLAN configured in the subscriber.
----------------------------	---

<b>Log ID</b>	PPPOE_UNKNOWN_DISCOVERY_PACKET
<b>Message</b>	Received unknown PPPoE discovery packet on interface %s, MAC %s, S-Tag %s, C-Tag %s, session-id %s
<b>Description</b>	Received unknown PPPoE discovery packet.
<b>Log Module</b>	pppoe
<b>Log Group</b>	pppoe
<b>Severity</b>	info
<b>Recommended Actions</b>	Check the options and VLAN configured in the subscriber.

<b>Log ID</b>	PPPOE_SESSION_CREATE
<b>Message</b>	PPPoE session created on interface %s, S-Tag %s, C-Tag %s, MAC %s, PPPoE session-id %s, subscriber-id %s, state %s access-profile %s
<b>Description</b>	Creation of the PPPoE/PPP session after PADS is sent.
<b>Log Module</b>	pppoe
<b>Log Group</b>	pppoe
<b>Severity</b>	info
<b>Recommended Actions</b>	No action required.

<b>Log ID</b>	PPPOE_SESSION_LIMIT_REACHED
<b>Message</b>	PPPoE session limit reached on interface %s, MAC %s, S-Tag %s, C-Tag %s
<b>Description</b>	PPPoE session limit reached.
<b>Log Module</b>	pppoe
<b>Log Group</b>	pppoe
<b>Severity</b>	notice

<b>Recommended Actions</b>	New sessions can be created only after removing existing sessions. Clear existing subscribers.
----------------------------	--

<b>Log ID</b>	PPPOE_PACKET_ENCODE_ERROR
<b>Message</b>	Could not encode PPPoE %s on interface %s, MAC %s, PPPoE session-id %s, S-Tag %s, C-Tag %s
<b>Description</b>	PPPoE discovery encode error.
<b>Log Module</b>	pppoe
<b>Log Group</b>	pppoe
<b>Severity</b>	info
<b>Recommended Actions</b>	No action required.

<b>Log ID</b>	PPPOE_BAD_PACKET_INTERFACE_GET_FAILED
<b>Message</b>	Interface get failed for PPPoE %s packet on interface %s, MAC %s
<b>Description</b>	PPPoE discovery packet has been received on the invalid interface.
<b>Log Module</b>	pppoe
<b>Log Group</b>	pppoe
<b>Severity</b>	info
<b>Recommended Actions</b>	Check the access interface configuration.

<b>Log ID</b>	PPPOE_BAD_PACKET_INTERFACE_DOWN
<b>Message</b>	Received PPPoE %s packet on operationaly down interface %s, MAC %s
<b>Description</b>	PPPoE discovery packet has been received on the interface that is down.
<b>Log Module</b>	pppoe
<b>Log Group</b>	pppoe
<b>Severity</b>	info

<b>Recommended Actions</b>	Verify the access interface state.
----------------------------	------------------------------------

<b>Log ID</b>	PPPOE_BAD_PACKET_WRONG_MAC
<b>Message</b>	Received bad PPPoE %s packet with wrong MAC on interface %s, MAC %s
<b>Description</b>	Invalid PPPoE discovery packet has been received with the wrong MAC address.
<b>Log Module</b>	pppoe
<b>Log Group</b>	pppoe
<b>Severity</b>	info
<b>Recommended Actions</b>	Restart the subscriber.

<b>Log ID</b>	PPPOE_BAD_PACKET_NO_AC_COOKIE
<b>Message</b>	Received bad PPPoE %s packet on interface %s, MAC %s with no ac cookie
<b>Description</b>	Invalid PPPoE discovery packet has been received with no <b>ac_cookie</b> .
<b>Log Module</b>	pppoe
<b>Log Group</b>	pppoe
<b>Severity</b>	info
<b>Recommended Actions</b>	No action required.

<b>Log ID</b>	PPPOE_BAD_PACKET_WRONG_AC_COOKIE
<b>Message</b>	Received bad PPPoE %s packet on interface %s, MAC %s with wrong ac cookie
<b>Description</b>	Invalid PPPoE discovery packet has been received with the wrong <b>ac_cookie</b> .
<b>Log Module</b>	pppoe
<b>Log Group</b>	pppoe
<b>Severity</b>	info

<b>Recommended Actions</b>	No action required.
----------------------------	---------------------

<b>Log ID</b>	PPPOE_BAD_PACKET_UNKNOWN_ETHER_TYPE
<b>Message</b>	Received bad PPPoE packet on interface %s, MAC %s with unknown ether type %s
<b>Description</b>	Received PPPoE discovery packet with an invalid ether type.
<b>Log Module</b>	pppoe
<b>Log Group</b>	pppoe
<b>Severity</b>	info
<b>Recommended Actions</b>	Verify the subscriber configuration.

<b>Log ID</b>	PPPOE_SESSION_DELETE
<b>Message</b>	PPPoE session delete on interface %s, MAC %s, PPPoE session-id %s, S-Tag %s, C-Tag %s
<b>Description</b>	PPPoE session deletion occurred.
<b>Log Module</b>	pppoe
<b>Log Group</b>	pppoe
<b>Severity</b>	info
<b>Recommended Actions</b>	No action required.

<b>Log ID</b>	PPPOE_DHCPV6_DECODE_ERROR
<b>Message</b>	PPPoE DHCPv6 packet decode error on interface %s, subscriber-id %s error code: %s subcode: %s
<b>Description</b>	Failed to decode the received PPPoE DHCPv6 packet.
<b>Log Module</b>	pppoe
<b>Log Group</b>	dhcpv6
<b>Severity</b>	info
<b>Recommended Actions</b>	No action required.

<b>Log ID</b>	PPPOE_DHCPV6_VALIDATION_ERROR
<b>Message</b>	PPPoE DHCPv6 packet validation error on interface %s, subscriber-id %s
<b>Description</b>	Failed to validate the received PPPoE DHCPv6 packet.
<b>Log Module</b>	pppoe
<b>Log Group</b>	dhcpv6
<b>Severity</b>	info
<b>Recommended Actions</b>	No action required.

<b>Log ID</b>	PPPOE_VENDOR_REQUEST_FAILED
<b>Message</b>	LCP vendor request failed for subscriber-id %s, %s
<b>Description</b>	PPPoE PPP LCP vendor request failure.
<b>Log Module</b>	pppoe
<b>Log Group</b>	ppp
<b>Severity</b>	info
<b>Recommended Actions</b>	No action required.

<b>Log ID</b>	PPPOE_RECEIVE_ERROR
<b>Message</b>	PPPOE packet receive with %s
<b>Description</b>	Generic PPPoE receive error.
<b>Log Module</b>	pppoe
<b>Log Group</b>	general
<b>Severity</b>	debug
<b>Recommended Actions</b>	No action required.

<b>Log ID</b>	PPPOE_CONFIG_FOUND
<b>Message</b>	PPPoE %s received on interface %s, MAC %s, S-Tag %s, C-Tag %s, found access-profile %s

<b>Description</b>	Received PPPoE discovery packet with a matching configuration.
<b>Log Module</b>	pppoe
<b>Log Group</b>	config
<b>Severity</b>	debug
<b>Recommended Actions</b>	No action required.

<b>Log ID</b>	PPPOE_SUBSCRIBER_IN
<b>Message</b>	Result from subscriberd for subscriber-id %s with action %s
<b>Description</b>	Action received from <b>subscriberd</b> .
<b>Log Module</b>	pppoe
<b>Log Group</b>	subscriber
<b>Severity</b>	debug
<b>Recommended Actions</b>	No action required.

<b>Log ID</b>	PPPOE_LCP_SESSION_EVENT
<b>Message</b>	LCP session %s on interface %s, MAC %s, PPPoE session-id %s, subscriber-id %s
<b>Description</b>	PPP LCP protocol events.
<b>Log Module</b>	pppoe
<b>Log Group</b>	ppp
<b>Severity</b>	debug
<b>Recommended Actions</b>	No action required.

<b>Log ID</b>	PPPOE_IPCP_SESSION_EVENT
<b>Message</b>	IPCP session %s on interface %s, MAC %s, PPPoE session-id %s, subscriber-id %s
<b>Description</b>	PPP IPCP protocol events.
<b>Log Module</b>	pppoe

<b>Log Group</b>	ppp
<b>Severity</b>	debug
<b>Recommended Actions</b>	No action required.

<b>Log ID</b>	PPPOE_IP6CP_SESSION_EVENT
<b>Message</b>	IP6CP session %s on interface %s, MAC %s, PPPoE session-id %s, subscriber-id %s
<b>Description</b>	PPP IP6CP protocol events
<b>Log Module</b>	pppoe
<b>Log Group</b>	ppp
<b>Severity</b>	debug
<b>Recommended Actions</b>	Contact Rtbrick customer support

<b>Log ID</b>	PPPOE_LCP_PRINT_MY_OPTIONS
<b>Message</b>	PPP LCP options for subscriber-id %s, MRU %s, magic %s, authentication %s, identifier %s, retransmission-count %s, retransmission-interval %s
<b>Description</b>	Local PPP LCP options.
<b>Log Module</b>	pppoe
<b>Log Group</b>	ppp
<b>Severity</b>	debug
<b>Recommended Actions</b>	No action required.

<b>Log ID</b>	PPPOE_LCP_START_ECHO
<b>Message</b>	LCP start echo on interface %s, subscriber-id %s
<b>Description</b>	Started sending the PPP LCP echo request interval.
<b>Log Module</b>	pppoe
<b>Log Group</b>	ppp
<b>Severity</b>	debug

<b>Recommended Actions</b>	No action required.
----------------------------	---------------------

<b>Log ID</b>	PPPOE_LCP_RCV_CONFX
<b>Message</b>	PPP LCP %s received on interface %s, subscriber-id %s, MRU %s, magic %s, authentication %s
<b>Description</b>	PPP LCP request/response has been received.
<b>Log Module</b>	pppoe
<b>Log Group</b>	ppp
<b>Severity</b>	debug
<b>Recommended Actions</b>	No action required.

<b>Log ID</b>	PPPOE_LCP_NEGOTIATION
<b>Message</b>	LCP %s on interface %s for subscriber-id %s
<b>Description</b>	PPP LCP negotiation occurred.
<b>Log Module</b>	pppoe
<b>Log Group</b>	ppp
<b>Severity</b>	debug
<b>Recommended Actions</b>	No action required.

<b>Log ID</b>	PPPOE_LCP_SETUP
<b>Message</b>	LCP setup %s on interface %s for subscriber-id %s
<b>Description</b>	PPPoE PPP sessions setup.
<b>Log Module</b>	pppoe
<b>Log Group</b>	ppp
<b>Severity</b>	debug
<b>Recommended Actions</b>	No action required.

<b>Log ID</b>	PPPOE_AUTH_RCV_REQ
---------------	--------------------



<b>Message</b>	%s receive request packet on interface %s, subscriber-id %s, user %s
<b>Description</b>	PPPoE PPP authentication request has been received.
<b>Log Module</b>	pppoe
<b>Log Group</b>	ppp
<b>Severity</b>	debug
<b>Recommended Actions</b>	No action required.

<b>Log ID</b>	PPPOE_LCP_UPPER_LAYER_TEARDOWN
<b>Message</b>	LCP teardown by upper layer on interface %s for subscriber-id %s
<b>Description</b>	PPPoE PPP session teardown/termination.
<b>Log Module</b>	pppoe
<b>Log Group</b>	ppp
<b>Severity</b>	debug
<b>Recommended Actions</b>	No action required.

<b>Log ID</b>	PPPOE_NCP_SESSION_DETAIL
<b>Message</b>	%s session on interface %s, subscriber-id %s, retransmission-interval %s, local ipv4 address %s
<b>Description</b>	PPPoE PPP NCP local session information.
<b>Log Module</b>	pppoe
<b>Log Group</b>	ppp
<b>Severity</b>	debug
<b>Recommended Actions</b>	No action required.

<b>Log ID</b>	PPPOE_IPCP_CONFREQ_PEER
<b>Message</b>	IPCP CONFREQ peer info for subscriber-id %s on interface %s, peer ipv4-address %s, primary dns %s, secondary dns %s

<b>Description</b>	PPPoE PPP IPCP session information.
<b>Log Module</b>	pppoe
<b>Log Group</b>	ppp
<b>Severity</b>	debug
<b>Recommended Actions</b>	No action required.

<b>Log ID</b>	PPPOE_IPCP_CONFREQ
<b>Message</b>	IPCP CONFREQ received for subscriber-id %s on interface %s, peer ipv4-address %s, primary dns %s, secondary dns %s
<b>Description</b>	PPPoE PPP IPCP has been received.
<b>Log Module</b>	pppoe
<b>Log Group</b>	ppp
<b>Severity</b>	debug
<b>Recommended Actions</b>	No action required.

<b>Log ID</b>	PPPOE_DISCOVERY_PACKET_RECEIVE
<b>Message</b>	Received PPPoE %s packet on interface %s, MAC %s, session-id %s
<b>Description</b>	Received PPPoE discovery packet.
<b>Log Module</b>	pppoe
<b>Log Group</b>	pppoe
<b>Severity</b>	debug
<b>Recommended Actions</b>	No action required.

<b>Log ID</b>	PPPOE_DISCOVERY_PACKET_SEND
<b>Message</b>	Sending PPPoE %s packet on interface %s, MAC %s, session-id %s
<b>Description</b>	Sent PPPoE discovery packet.
<b>Log Module</b>	pppoe

<b>Log Group</b>	pppoe
<b>Severity</b>	debug
<b>Recommended Actions</b>	No action required.

<b>Log ID</b>	PPPOE_DHCPV6_LEASE
<b>Message</b>	PPPoE DHCPv6 IA_PD %s for subscriber-id %s, MAC %s, S-Tag %s, C-Tag %s
<b>Description</b>	PPPoE DHCPv6 IA_PD lease.
<b>Log Module</b>	pppoe
<b>Log Group</b>	dhcpv6
<b>Severity</b>	debug
<b>Recommended Actions</b>	No action required.

<b>Log ID</b>	PPPOE_FSM_ACTION_FAILED
<b>Message</b>	%s session for subscriber-id %s, MAC %s, S-Tag %s, C-Tag %s action %s failed
<b>Description</b>	PPP FSM action failure.
<b>Log Module</b>	pppoe
<b>Log Group</b>	ppp
<b>Severity</b>	debug
<b>Recommended Actions</b>	No action required.

<b>Log ID</b>	PPPOE_PADT_RECEIVED
<b>Message</b>	PPPoE PADT received for subscriber-id %s on interface %s, MAC %s, S-Tag %s, C-Tag %s
<b>Description</b>	Received PPPoE <b>padt</b> packet.
<b>Log Module</b>	pppoe
<b>Log Group</b>	config
<b>Severity</b>	debug

<b>Recommended Actions</b>	No action required.
----------------------------	---------------------

## Routing Information Base (RIB) Log Messages

<b>Log ID</b>	RIB_OPER_ROUTER_ID_ADD
<b>Message</b>	Add router-id %s, instance %s
<b>Description</b>	Router ID configuration change is triggered.
<b>Log Module</b>	RIB
<b>Log Group</b>	config
<b>Severity</b>	info
<b>Recommended Action</b>	Check the router ID configuration for the instance.

<b>Log ID</b>	RIB_OPER_ROUTER_ID_DEL
<b>Message</b>	Delete router-id %s, instance %s
<b>Description</b>	Router-ID configuration change is triggered.
<b>Log Module</b>	RIB
<b>Log Group</b>	config
<b>Severity</b>	info
<b>Recommended Action</b>	Check the router ID configurations for the instance.

<b>Log ID</b>	RIB_OPER_ROUTER_ID_UPDATE
<b>Message</b>	Change router-id, instance %s, from %s to %s
<b>Description</b>	Router ID configuration change is triggered.
<b>Log Module</b>	RIB
<b>Log Group</b>	config
<b>Severity</b>	info

<b>Recommended Action</b>	Check the router ID configurations for the instance.
---------------------------	--

<b>Log ID</b>	RIB_OPER_IPV4_NEIGHBOR_ADD
<b>Message</b>	Add ipv4 neighbor, interface %s, address %s
<b>Description</b>	New IPv4 neighbor is detected.
<b>Log Module</b>	RIB
<b>Log Group</b>	neighbor-events
<b>Severity</b>	info
<b>Recommended Action</b>	Check the IPv4 neighbor details.

<b>Log ID</b>	RIB_OPER_IPV4_NEIGHBOR_DELETE
<b>Message</b>	Delete ipv4 neighbor, interface %s, address %s
<b>Description</b>	The IPv4 neighbor is deleted.
<b>Log Module</b>	RIB
<b>Log Group</b>	neighbor-events
<b>Severity</b>	info
<b>Recommended Action</b>	Check the IFL status.

<b>Log ID</b>	RIB_OPER_IPV6_NEIGHBOR_ADD
<b>Message</b>	Add ipv6 neighbor, interface %s, address %s
<b>Description</b>	New IPv6 neighbor is detected.
<b>Log Module</b>	RIB
<b>Log Group</b>	neighbor-events
<b>Severity</b>	info

<b>Recommended Action</b>	Check the IPv6 neighbor details.
---------------------------	----------------------------------

<b>Log ID</b>	RIB_OPER_IPV6_NEIGHBOR_DELETE
<b>Message</b>	Delete ipv6 neighbor, interface %s, address %s
<b>Description</b>	The IPv6 neighbor is deleted.
<b>Log Module</b>	RIB
<b>Log Group</b>	neighbor-events
<b>Severity</b>	info
<b>Recommended Action</b>	Check the IPv6 neighbor details.

### Subscriber Management Log Messages

<b>Log ID</b>	SUBSMGMT_AAA_PROFILE_NOT_FOUND
<b>Message</b>	AAA configuration profile %s not found for subscriber %s
<b>Description</b>	This event log is generated if the authentication, authorization, and accounting (AAA) configuration profile for the subscriber has not been found.
<b>Log Module</b>	subsMgmt
<b>Log Group</b>	config
<b>Severity</b>	warning
<b>Recommended Actions</b>	Verify the AAA profile configuration.

<b>Log ID</b>	SUBSMGMT_AAA_PROFILE_INVALID_ORDER
<b>Message</b>	AAA configuration profile %s invalid configuration order for subscriber %s
<b>Description</b>	AAA configuration profile is not in valid order.
<b>Log Module</b>	subsMgmt

<b>Log Group</b>	config
<b>Severity</b>	info
<b>Recommended Actions</b>	Verify the authentication and accounting order in the AAA profile configuration.

<b>Log ID</b>	SUBSMGMT_RADIUS_PROFILE_MISSING_IN_AAA
<b>Message</b>	RADIUS profile missing in AAA profile %s for subscriber %s
<b>Description</b>	Missing RADIUS profile in AAA profile.
<b>Log Module</b>	subsMgmt
<b>Log Group</b>	config
<b>Severity</b>	warning
<b>Recommended Actions</b>	Verify the RADIUS profile in the AAA profile configuration.

<b>Log ID</b>	SUBSMGMT_MISSING_AAA_CONFIG
<b>Message</b>	missing AAA %s for subscriber %s
<b>Description</b>	Subscriber AAA configuration warning.
<b>Log Module</b>	subsMgmt
<b>Log Group</b>	config
<b>Severity</b>	warning
<b>Recommended Actions</b>	Configure missing AAA configuration.

<b>Log ID</b>	SUBSMGMT_AUTHENTICATION_FAILED
<b>Message</b>	Authentication failed for subscriber %s due to %s
<b>Description</b>	Subscriber authentication failure.
<b>Log Module</b>	subsMgmt
<b>Log Group</b>	subscriber
<b>Severity</b>	info
<b>Recommended Actions</b>	Check the local/radius authentication configuration.

<b>Log ID</b>	SUBSMGMT_ACCT_SESSION_ID_NOT_FOUND
<b>Message</b>	No subscriber with Acct-Session-ID %s found
<b>Description</b>	a CoA request with an unknown <b>Acct-Session-ID</b> has been received.
<b>Log Module</b>	subsMgmt
<b>Log Group</b>	subscriber
<b>Severity</b>	info
<b>Recommended Actions</b>	No action required.

<b>Log ID</b>	SUBSMGMT_SUBSCRIBER_ADD
<b>Message</b>	Subscriber %s added
<b>Description</b>	New subscriber has been added.
<b>Log Module</b>	subsMgmt
<b>Log Group</b>	subscriber
<b>Severity</b>	info
<b>Recommended Actions</b>	No action required.

<b>Log ID</b>	SUBSMGMT_SUBSCRIBER_DEL
<b>Message</b>	Subscriber %s deleted
<b>Description</b>	Subscriber has been deleted.
<b>Log Module</b>	subsMgmt
<b>Log Group</b>	subscriber
<b>Severity</b>	info
<b>Recommended Actions</b>	No action required.

<b>Log ID</b>	SUBSMGMT_SUBSCRIBER_NOT_FOUND
<b>Message</b>	Subscriber %s not found
<b>Description</b>	Subscriber is not found.



<b>Log Module</b>	subsMgmt
<b>Log Group</b>	subscriber
<b>Severity</b>	info
<b>Recommended Actions</b>	No action required.

<b>Log ID</b>	SUBSMGMT_TRAP_ADD
<b>Message</b>	Failed to add I/O trap %s
<b>Description</b>	Failed to add input/output trap entry.
<b>Log Module</b>	subsMgmt
<b>Log Group</b>	subscriber
<b>Severity</b>	notice
<b>Recommended Actions</b>	Check the FIB and RIB logs.

<b>Log ID</b>	SUBSMGMT_TRAP_DEL
<b>Message</b>	Failed to delete I/O trap %s
<b>Description</b>	Failed to delete input/output trap entry.
<b>Log Module</b>	subsMgmt
<b>Log Group</b>	subscriber
<b>Severity</b>	info
<b>Recommended Actions</b>	Check the FIB and RIB logs.

<b>Log ID</b>	SUBSMGMT_QOS_SHAPER
<b>Message</b>	Invalid dynamic shaper definition %s for subscriber %s
<b>Description</b>	Invalid subscriber QoS shaper definition has been received.
<b>Log Module</b>	subsMgmt
<b>Log Group</b>	subscriber
<b>Severity</b>	notice

<b>Recommended Actions</b>	No action required.
----------------------------	---------------------

<b>Log ID</b>	SUBSMGMT_QOS_POLICER
<b>Message</b>	Invalid dynamic policer definition %s for subscriber %s
<b>Description</b>	Invalid subscriber QoS policer definition has been received.
<b>Log Module</b>	subsMgmt
<b>Log Group</b>	subscriber
<b>Severity</b>	notice
<b>Recommended Actions</b>	No action required.

<b>Log ID</b>	SUBSMGMT_IPV4_DUPLICATE_ADDRESS_DETECTED
<b>Message</b>	Duplicate IPv4 address %s detected for subscriber %s
<b>Description</b>	Duplicate IPv4 address has been detected.
<b>Log Module</b>	subsMgmt
<b>Log Group</b>	subscriber
<b>Severity</b>	notice
<b>Recommended Actions</b>	Verify the IPv4 address allocation configuration.

<b>Log ID</b>	SUBSMGMT_IPV6_DUPLICATE_ADDRESS_DETECTED
<b>Message</b>	Duplicate IPv6 prefix %s detected for subscriber %s
<b>Description</b>	Duplicate IPv6 address has been detected.
<b>Log Module</b>	subsMgmt
<b>Log Group</b>	subscriber
<b>Severity</b>	notice
<b>Recommended Actions</b>	Verify the IPv6 address allocation configuration.

<b>Log ID</b>	SUBSMGMT_INSTANCE_NOT_FOUND
<b>Message</b>	Instance %s not found for subscriber %s

<b>Description</b>	Instance is not found.
<b>Log Module</b>	subsMgmt
<b>Log Group</b>	subscriber
<b>Severity</b>	notice
<b>Recommended Actions</b>	Configure the subscriber instance.

<b>Log ID</b>	SUBSMGMT_FSM_EVENT
<b>Message</b>	Subscriber %s FSM State change, from %s, event %s, to %s
<b>Description</b>	Subscriber FSM state transition.
<b>Log Module</b>	subsMgmt
<b>Log Group</b>	subscriberfsm
<b>Severity</b>	info
<b>Recommended Actions</b>	No action required.

<b>Log ID</b>	SUBSMGMT_POOL_IPV4_EXHAUSTED
<b>Message</b>	IPv4 pool %s exhausted for subscriber %s
<b>Description</b>	Local IPv4 address pool has exhausted.
<b>Log Module</b>	subsMgmt
<b>Log Group</b>	pool
<b>Severity</b>	notice
<b>Recommended Actions</b>	Free up IPv4 addresses.

<b>Log ID</b>	SUBSMGMT_POOL_IPV6_EXHAUSTED
<b>Message</b>	IPv6 pool %s exhausted for subscriber %s
<b>Description</b>	Local IPv6 address pool has exhausted.
<b>Log Module</b>	subsMgmt
<b>Log Group</b>	pool
<b>Severity</b>	notice

<b>Recommended Actions</b>	Free up IPv6 addresses.
----------------------------	-------------------------

<b>Log ID</b>	SUBSMGMT_QOS_QUEUE
<b>Message</b>	Invalid dynamic queue definition %s for subscriber %s
<b>Description</b>	Invalid subscriber QoS queue definition has been received.
<b>Log Module</b>	subsMgmt
<b>Log Group</b>	subscriber
<b>Severity</b>	notice
<b>Recommended Actions</b>	No action required.

<b>Log ID</b>	SUBSMGMT_FUNCTION_INVOCATION
<b>Message</b>	Subscriber Daemon %s Function invoked
<b>Description</b>	Function calls in SubscriberD.
<b>Log Module</b>	subsMgmt
<b>Log Group</b>	general
<b>Severity</b>	debug
<b>Recommended Actions</b>	No action required.

<b>Log ID</b>	SUBSMGMT_SERVICE_PROFILE_GET_FAILED
<b>Message</b>	Failed to get service profile %s for subscriber %s
<b>Description</b>	Failed to get service configuration profile.
<b>Log Module</b>	subsMgmt
<b>Log Group</b>	config
<b>Severity</b>	debug
<b>Recommended Actions</b>	Reconfigure the service profile.

<b>Log ID</b>	SUBSMGMT_INTERNAL_AUTHENTICATION
<b>Message</b>	Failed to %s during authentication for subscriber %s

<b>Description</b>	General subscriber authentication warning.
<b>Log Module</b>	subsMgmt
<b>Log Group</b>	subscriber
<b>Severity</b>	warning
<b>Recommended Actions</b>	No action required.

<b>Log ID</b>	SUBSMGMT_INTERNAL_ACCOUNTING
<b>Message</b>	Failed to %s during accounting for subscriber %s
<b>Description</b>	General subscriber accounting warning.
<b>Log Module</b>	subsMgmt
<b>Log Group</b>	subscriber
<b>Severity</b>	warning
<b>Recommended Actions</b>	No action required.

<b>Log ID</b>	SUBSMGMT_PPPOE_RESULT
<b>Message</b>	Failed to %s from PPPoE for subscriber %s
<b>Description</b>	General subscriber PPPoE related errors.
<b>Log Module</b>	subsMgmt
<b>Log Group</b>	subscriber
<b>Severity</b>	debug
<b>Recommended Actions</b>	No action required.

<b>Log ID</b>	SUBSMGMT_L2TP_RESULT
<b>Message</b>	Failed to extract the L2TP result
<b>Description</b>	General subscriber L2TP related errors.
<b>Log Module</b>	subsMgmt
<b>Log Group</b>	subscriber
<b>Severity</b>	debug

<b>Recommended Actions</b>	No action required.
----------------------------	---------------------

<b>Log ID</b>	SUBSMGMT_ACCOUNTING_STOP_PROGRESS
<b>Message</b>	Accounting STOP in progress for subscriber %s
<b>Description</b>	Subscriber waits for the final counter update.
<b>Log Module</b>	subsMgmt
<b>Log Group</b>	subscriber
<b>Severity</b>	debug
<b>Recommended Actions</b>	No action required.

<b>Log ID</b>	SUBSMGMT_IFL_CREATE
<b>Message</b>	Failed to create %s for subscriber %s
<b>Description</b>	Subscriber logical interface errors.
<b>Log Module</b>	subsMgmt
<b>Log Group</b>	subscriber
<b>Severity</b>	info
<b>Recommended Actions</b>	No action required.

<b>Log ID</b>	SUBSMGMT_IFL_DELETE
<b>Message</b>	Failed to delete %s for ifl %s
<b>Description</b>	Subscriber logical interface delete event.
<b>Log Module</b>	subsMgmt
<b>Log Group</b>	subscriber
<b>Severity</b>	debug
<b>Recommended Actions</b>	No action required.

<b>Log ID</b>	SUBSMGMT_QOS_CREATE
<b>Message</b>	QoS settings created for subscriber %s with IFL %s

<b>Description</b>	Add subscriber QoS settings.
<b>Log Module</b>	subsMgmt
<b>Log Group</b>	subscriber
<b>Severity</b>	debug
<b>Recommended Actions</b>	No action required.

<b>Log ID</b>	SUBSMGMT_QOS_RESET
<b>Message</b>	QoS settings reset for subscriber %s with IFL %s
<b>Description</b>	Reset subscriber QoS settings.
<b>Log Module</b>	subsMgmt
<b>Log Group</b>	subscriber
<b>Severity</b>	debug
<b>Recommended Actions</b>	No action required.

<b>Log ID</b>	SUBSMGMT_QOS_UPDATE
<b>Message</b>	QoS settings updated for subscriber %s with IFL %s
<b>Description</b>	Subscriber QoS setting is updated.
<b>Log Module</b>	subsMgmt
<b>Log Group</b>	subscriber
<b>Severity</b>	debug
<b>Recommended Actions</b>	No Action required.

<b>Log ID</b>	SUBSMGMT_BDS_TABLE_CREATED
<b>Message</b>	BDS table %s created
<b>Description</b>	BDS table has been created.
<b>Log Module</b>	subsMgmt
<b>Log Group</b>	bds
<b>Severity</b>	debug

<b>Recommended Actions</b>	No action required.
----------------------------	---------------------

<b>Log ID</b>	SUBSMGMT_BDS_TABLE_CREATE_ERROR
<b>Message</b>	Failed to create BDS table %s
<b>Description</b>	Failed to create BDS table.
<b>Log Module</b>	subsMgmt
<b>Log Group</b>	bds
<b>Severity</b>	debug
<b>Recommended Actions</b>	No action required.

<b>Log ID</b>	SUBSMGMT_BDS_TABLE_GET_ERROR
<b>Message</b>	Failed to get BDS table %s
<b>Description</b>	Failed to receive BDS table or the BDS table is not found.
<b>Log Module</b>	subsMgmt
<b>Log Group</b>	bds
<b>Severity</b>	debug
<b>Recommended Actions</b>	No action required.

<b>Log ID</b>	SUBSMGMT_BDS_TEMPLATE_GET_ERROR
<b>Message</b>	Failed to get BDS object template %s
<b>Description</b>	Failed to receive the BDS object template.
<b>Log Module</b>	subsMgmt
<b>Log Group</b>	bds
<b>Severity</b>	debug
<b>Recommended Actions</b>	No action required.

<b>Log ID</b>	SUBSMGMT_BDS_TEMPLATE_POPULATE_ERROR
<b>Message</b>	Failed to populate BDS object template %s



<b>Description</b>	Failed to populate BDS object template.
<b>Log Module</b>	subsMgmt
<b>Log Group</b>	bds
<b>Severity</b>	debug
<b>Recommended Actions</b>	No action required.

<b>Log ID</b>	SUBSMGMT_BDS_OBJECT_ADD_ERROR
<b>Message</b>	Failed to add BDS object to table %s
<b>Description</b>	Failed to add BDS object to the table.
<b>Log Module</b>	subsMgmt
<b>Log Group</b>	bds
<b>Severity</b>	debug
<b>Recommended Actions</b>	No action required.

<b>Log ID</b>	SUBSMGMT_BDS_OBJECT_DEL_ERROR
<b>Message</b>	Failed to delete BDS object from table %s
<b>Description</b>	Failed to delete BDS object from the table.
<b>Log Module</b>	subsMgmt
<b>Log Group</b>	bds
<b>Severity</b>	debug
<b>Recommended Actions</b>	No action required.

<b>Log ID</b>	SUBSMGMT_RADIUS_PROFILE_ACTIVATE
<b>Message</b>	Failed to activate RADIUS profile
<b>Description</b>	RADIUS profile activation event.
<b>Log Module</b>	subsMgmt
<b>Log Group</b>	radius
<b>Severity</b>	debug

<b>Recommended Actions</b>	No action required.
----------------------------	---------------------

<b>Log ID</b>	SUBSMGMT_RADIUS_ACCOUNTING_QUEUE_INDEX
<b>Message</b>	RADIUS accounting queue index exhausted
<b>Description</b>	RADIUS accounting queue index
<b>Log Module</b>	subsMgmt
<b>Log Group</b>	radius
<b>Severity</b>	debug
<b>Recommended Actions</b>	Contact RtBrick customer support

<b>Log ID</b>	SUBSMGMT_RADIUS_AUTHENTICATION_QUEUE_INDEX
<b>Message</b>	RADIUS authentication queue index is exhausted
<b>Description</b>	RADIUS accounting queue index exhausted.
<b>Log Module</b>	subsMgmt
<b>Log Group</b>	radius
<b>Severity</b>	debug
<b>Recommended Actions</b>	No action required.

<b>Log ID</b>	SUBSMGMT_RADIUS_ACCOUNTING_EVENT
<b>Message</b>	Failed to %s RADIUS accounting request from %s
<b>Description</b>	RADIUS accounting event.
<b>Log Module</b>	subsMgmt
<b>Log Group</b>	radius
<b>Severity</b>	debug
<b>Recommended Actions</b>	No action required.

<b>Log ID</b>	SUBSMGMT_RADIUS_PROFILE_ADDED
<b>Message</b>	RADIUS Profile %s added

<b>Description</b>	Added a RADIUS profile.
<b>Log Module</b>	subsMgmt
<b>Log Group</b>	radius
<b>Severity</b>	debug
<b>Recommended Actions</b>	No action required.

<b>Log ID</b>	SUBSMGMT_RADIUS_PROFILE_DELETED
<b>Message</b>	RADIUS profile %s deleted
<b>Description</b>	RADIUS profile has been deleted.
<b>Log Module</b>	subsMgmt
<b>Log Group</b>	radius
<b>Severity</b>	debug
<b>Recommended Actions</b>	No action required.

<b>Log ID</b>	SUBSMGMT_RADIUS_PROFILE_NOT_FOUND
<b>Message</b>	RADIUS profile %s not found
<b>Description</b>	RADIUS profile has not been found.
<b>Log Module</b>	subsMgmt
<b>Log Group</b>	radius
<b>Severity</b>	debug
<b>Recommended Actions</b>	No action required.

<b>Log ID</b>	SUBSMGMT_RADIUS_SERVER_ADDED
<b>Message</b>	RADIUS server %s added
<b>Description</b>	RADIUS server has been added.
<b>Log Module</b>	subsMgmt
<b>Log Group</b>	radius
<b>Severity</b>	debug

<b>Recommended Actions</b>	No action required.
----------------------------	---------------------

<b>Log ID</b>	SUBSMGMT_RADIUS_SERVER_DELETED
<b>Message</b>	RADIUS server %s deleted
<b>Description</b>	RADIUS server has been deleted.
<b>Log Module</b>	subsMgmt
<b>Log Group</b>	radius
<b>Severity</b>	debug
<b>Recommended Actions</b>	No action required.

<b>Log ID</b>	SUBSMGMT_RADIUS_SERVER_DELETE_FAILED
<b>Message</b>	Failed to delete RADIUS server %s
<b>Description</b>	RADIUS server deletion failure.
<b>Log Module</b>	subsMgmt
<b>Log Group</b>	radius
<b>Severity</b>	debug
<b>Recommended Actions</b>	No action required.

<b>Log ID</b>	SUBSMGMT_RADIUS_SERVER_NOT_FOUND
<b>Message</b>	RADIUS server %s not found
<b>Description</b>	RADIUS server is not found.
<b>Log Module</b>	subsMgmt
<b>Log Group</b>	radius
<b>Severity</b>	debug
<b>Recommended Actions</b>	Configure RADIUS server.

<b>Log ID</b>	SUBSMGMT_RADIUS_SERVER_ACCOUNTING_DISABLED
<b>Message</b>	RADIUS server %s accounting disabled

<b>Description</b>	RADIUS server accounting has been disabled.
<b>Log Module</b>	subsMgmt
<b>Log Group</b>	radius
<b>Severity</b>	debug
<b>Recommended Actions</b>	Check the RADIUS server configuration.

<b>Log ID</b>	SUBSMGMT_RADIUS_SERVER_AUTHENTICATION_DISABLED
<b>Message</b>	RADIUS server %s authentication disabled
<b>Description</b>	RADIUS server authentication has been disabled.
<b>Log Module</b>	subsMgmt
<b>Log Group</b>	radius
<b>Severity</b>	debug
<b>Recommended Actions</b>	Check the RADIUS server configuration.

<b>Log ID</b>	SUBSMGMT_RADIUS_SERVER_UNKNOWN
<b>Message</b>	RADIUS message from unknown server %s
<b>Description</b>	RADIUS requests from unknown IPv4 addresses.
<b>Log Module</b>	subsMgmt
<b>Log Group</b>	radius
<b>Severity</b>	debug
<b>Recommended Actions</b>	Check the RADIUS server configuration.

<b>Log ID</b>	SUBSMGMT_RADIUS_SERVER_GET_FAILED
<b>Message</b>	RADIUS server %s get failed while decoding RADIUS message %s
<b>Description</b>	RADIUS server failure.
<b>Log Module</b>	subsMgmt
<b>Log Group</b>	radius

<b>Severity</b>	debug
<b>Recommended Actions</b>	No action required.

<b>Log ID</b>	SUBSMGMT_RADIUS_TUNNEL_ERROR
<b>Message</b>	Tunnel error %s for subscriber %s
<b>Description</b>	RADIUS subscriber tunnel-related errors.
<b>Log Module</b>	subsMgmt
<b>Log Group</b>	radius
<b>Severity</b>	debug
<b>Recommended Actions</b>	No action required.

<b>Log ID</b>	SUBSMGMT_RADIUS_AUTHENTICATION_ERROR
<b>Message</b>	Authentication error %s for subscriber %s
<b>Description</b>	RADIUS subscriber tunnel-related errors.
<b>Log Module</b>	subsMgmt
<b>Log Group</b>	radius
<b>Severity</b>	debug
<b>Recommended Actions</b>	No action required.

<b>Log ID</b>	SUBSMGMT_RADIUS_ACCOUNTING_ERROR
<b>Message</b>	Accounting error %s for subscriber %s
<b>Description</b>	RADIUS subscriber accounting error.
<b>Log Module</b>	subsMgmt
<b>Log Group</b>	radius
<b>Severity</b>	debug
<b>Recommended Actions</b>	No action required.

<b>Log ID</b>	SUBSMGMT_RADIUS_ENCODE_ERROR
---------------	------------------------------

<b>Message</b>	Encode error %s for subscriber %s
<b>Description</b>	RADIUS encode error.
<b>Log Module</b>	subsMgmt
<b>Log Group</b>	radius
<b>Severity</b>	debug
<b>Recommended Actions</b>	Check RADIUS configurations.

<b>Log ID</b>	SUBSMGMT_RADIUS_AUTH_REQ
<b>Message</b>	Added RADIUS authentication request for subscriber %s from server %s
<b>Description</b>	RADIUS authentication request.
<b>Log Module</b>	subsMgmt
<b>Log Group</b>	radius
<b>Severity</b>	debug
<b>Recommended Actions</b>	No action required.

<b>Log ID</b>	SUBSMGMT_RADIUS_AUTH_REQ_ERROR
<b>Message</b>	Failed to add RADIUS authentication request for subscriber %s from server %s
<b>Description</b>	RADIUS authentication request failure.
<b>Log Module</b>	subsMgmt
<b>Log Group</b>	radius
<b>Severity</b>	debug
<b>Recommended Actions</b>	No action required.

<b>Log ID</b>	SUBSMGMT_RADIUS_ACCOUNTING_REQUEST
<b>Message</b>	Added RADIUS accounting request for subscriber %s from server %s
<b>Description</b>	RADIUS accounting request.

<b>Log Module</b>	subsMgmt
<b>Log Group</b>	radius
<b>Severity</b>	debug
<b>Recommended Actions</b>	No action required.

<b>Log ID</b>	SUBSMGMT_RADIUS_ACCOUNTING_REQUEST_ERROR
<b>Message</b>	Failed to add RADIUS accounting request for subscriber %s from server %s
<b>Description</b>	RADIUS accounting request failure.
<b>Log Module</b>	subsMgmt
<b>Log Group</b>	radius
<b>Severity</b>	debug
<b>Recommended Actions</b>	No action required.

<b>Log ID</b>	SUBSMGMT_RADIUS_AUTH_STATE_CHANGE
<b>Message</b>	RADIUS Server %s Authentication State changed from %s to %s
<b>Description</b>	State change in RADIUS server authentication.
<b>Log Module</b>	subsMgmt
<b>Log Group</b>	radius
<b>Severity</b>	debug
<b>Recommended Actions</b>	No action required.

<b>Log ID</b>	SUBSMGMT_RADIUS_ACCT_STATE_CHANGE
<b>Message</b>	RADIUS Server %s Accounting State changed from %s to %s
<b>Description</b>	State change in RADIUS server accounting.
<b>Log Module</b>	subsMgmt
<b>Log Group</b>	radius
<b>Severity</b>	debug



<b>Recommended Actions</b>	No action required.
----------------------------	---------------------

<b>Log ID</b>	SUBSMGMT_RADIUS_PROFILE_STATE_CHANGE
<b>Message</b>	RADIUS Profile %s State changed from %s to %s
<b>Description</b>	State change in RADIUS profile accounting.
<b>Log Module</b>	subsMgmt
<b>Log Group</b>	radius
<b>Severity</b>	debug
<b>Recommended Actions</b>	No action required.

<b>Log ID</b>	SUBSMGMT_RADIUS_PROFILE_ERROR
<b>Message</b>	RADIUS profile %s %s for subscriber %s
<b>Description</b>	RADIUS profile subscriber event.
<b>Log Module</b>	subsMgmt
<b>Log Group</b>	radius
<b>Severity</b>	debug
<b>Recommended Actions</b>	No action required.

<b>Log ID</b>	SUBSMGMT_RADIUS_DROPPED
<b>Message</b>	RADIUS message from %s dropped due to %s
<b>Description</b>	RADIUS message has been dropped.
<b>Log Module</b>	subsMgmt
<b>Log Group</b>	radius
<b>Severity</b>	debug
<b>Recommended Actions</b>	No action required.

<b>Log ID</b>	SUBSMGMT_RADIUS_ASCEND_DATA_FILTER
<b>Message</b>	Ascend Data Filter error for subscriber %s due to %s

<b>Description</b>	RADIUS filter message decode error.
<b>Log Module</b>	subsMgmt
<b>Log Group</b>	radius
<b>Severity</b>	notice
<b>Recommended Actions</b>	No action required.

<b>Log ID</b>	SUBSMGMT_RADIUS_ASCEND_DATA_FILTER_NOT_SUPPORTED
<b>Message</b>	Ascend Data Filter attribute %s with value %x not supported for subscriber %s
<b>Description</b>	RADIUS filter message decode error.
<b>Log Module</b>	subsMgmt
<b>Log Group</b>	radius
<b>Severity</b>	debug
<b>Recommended Actions</b>	No action required.

<b>Log ID</b>	SUBSMGMT_FSM_ERROR
<b>Message</b>	FSM Error for subscriber %s, State %s, Event %s
<b>Description</b>	Invalid event for the current state of subscriber FSM.
<b>Log Module</b>	subsMgmt
<b>Log Group</b>	subscriberfsm
<b>Severity</b>	debug
<b>Recommended Actions</b>	No action required.

<b>Log ID</b>	SUBSMGMT_FSM_NOT_FOUND
<b>Message</b>	Subscriber %s not found for FSM event %s
<b>Description</b>	Subscriber has not been found for the received FSM event.
<b>Log Module</b>	subsMgmt
<b>Log Group</b>	subscriberfsm

<b>Severity</b>	debug
<b>Recommended Actions</b>	No action required.

<b>Log ID</b>	SUBSMGMT_FSM_STATIC_IP_ALLOCATION
<b>Message</b>	Static IPv4 address from access-profile allocated for subscriber %s
<b>Description</b>	Subscriber FSM event logging.
<b>Log Module</b>	subsMgmt
<b>Log Group</b>	subscriberfsm
<b>Severity</b>	debug
<b>Recommended Actions</b>	No action required.

<b>Log ID</b>	SUBSMGMT_FSM_GENERAL_ERROR
<b>Message</b>	%s for subscriber %s
<b>Description</b>	Subscriber FSM Error logging.
<b>Log Module</b>	subsMgmt
<b>Log Group</b>	subscriberfsm
<b>Severity</b>	debug
<b>Recommended Actions</b>	No action required.

<b>Log ID</b>	SUBSMGMT_POOL_CONFIG
<b>Message</b>	Failed to process pool configuration
<b>Description</b>	Subscriber management Pool warning.
<b>Log Module</b>	subsMgmt
<b>Log Group</b>	pool
<b>Severity</b>	debug
<b>Recommended Actions</b>	Check the address pool configuration.

<b>Log ID</b>	SUBSMGMT_POOL_ASSIGN_IPV4
<b>Message</b>	Failed to assign ipv4 address for subscriber %s
<b>Description</b>	Subscriber management pool warning.
<b>Log Module</b>	subsMgmt
<b>Log Group</b>	pool
<b>Severity</b>	debug
<b>Recommended Actions</b>	Increase address pool size.

<b>Log ID</b>	SUBSMGMT_POOL_RELEASE_IPV4
<b>Message</b>	Failed to release ipv4 address for subscriber %s
<b>Description</b>	Subscriber management pool warning.
<b>Log Module</b>	subsMgmt
<b>Log Group</b>	pool
<b>Severity</b>	debug
<b>Recommended Actions</b>	Increase address pool size.

<b>Log ID</b>	SUBSMGMT_POOL_ASSIGN_IPV6
<b>Message</b>	Failed to assign ipv6 address for subscriber %s
<b>Description</b>	Subscriber management pool warning.
<b>Log Module</b>	subsMgmt
<b>Log Group</b>	pool
<b>Severity</b>	debug
<b>Recommended Actions</b>	Increase address pool size.

<b>Log ID</b>	SUBSMGMT_POOL_RELEASE_IPV6
<b>Message</b>	Failed to release ipv6 address for subscriber %s
<b>Description</b>	Subscriber management pool warning.
<b>Log Module</b>	subsMgmt

<b>Log Group</b>	pool
<b>Severity</b>	debug
<b>Recommended Actions</b>	No action required.

<b>Log ID</b>	SUBSMGMT_POOL_IPV4_SUCCESS
<b>Message</b>	IPv4 address %s from pool %s assigned to subscriber %s
<b>Description</b>	IPv4 address from the local address pool has been assigned.
<b>Log Module</b>	subsMgmt
<b>Log Group</b>	pool
<b>Severity</b>	debug
<b>Recommended Actions</b>	No action required.

<b>Log ID</b>	SUBSMGMT_POOL_IPV6_SUCCESS
<b>Message</b>	IPv6 prefix %s from pool %s assigned to subscriber %s
<b>Description</b>	IPv6 prefix from local address pool assigned.
<b>Log Module</b>	subsMgmt
<b>Log Group</b>	pool
<b>Severity</b>	debug
<b>Recommended Actions</b>	No action required.

<b>Log ID</b>	SUBSMGMT_TEST_AAA_RESULT
<b>Message</b>	Failed to %s from test aaa request for subscriber %s
<b>Description</b>	General test AAA requests related errors.
<b>Log Module</b>	subsMgmt
<b>Log Group</b>	subscriber
<b>Severity</b>	debug
<b>Recommended Actions</b>	No action required.

<b>Log ID</b>	SUBSMGMT_IPOE_RESULT
<b>Message</b>	Failed to %s from IPoE for subscriber %s
<b>Description</b>	General subscriber IPoE related errors.
<b>Log Module</b>	subsMgmt
<b>Log Group</b>	subscriber
<b>Severity</b>	debug
<b>Recommended Actions</b>	No action required.

<b>Log ID</b>	SUBSMGMT_L2BSA_GENERIC_ERROR
<b>Message</b>	%s
<b>Description</b>	General subscriber L2BSA related errors.
<b>Log Module</b>	subsMgmt
<b>Log Group</b>	subscriber
<b>Severity</b>	error
<b>Recommended Actions</b>	No action required.

<b>Log ID</b>	SUBSMGMT_L2BSA_RESULT
<b>Message</b>	Failed to %s from L2BSA service for subscriber %s
<b>Description</b>	General L2BSA subscriber related errors.
<b>Log Module</b>	subsMgmt
<b>Log Group</b>	l2bsa
<b>Severity</b>	debug
<b>Recommended Actions</b>	No action required.

<b>Log ID</b>	SUBSMGMT_PLATFORM_TYPE
<b>Message</b>	Platform type set to %s
<b>Description</b>	Platform type has been updated.
<b>Log Module</b>	subsMgmt

<b>Log Group</b>	general
<b>Severity</b>	debug
<b>Recommended Actions</b>	No action required.

<b>Log ID</b>	SUBSMGMT_RD_INVALID_OBJECT
<b>Message</b>	Redundancy object with invalid subscriber-id/rd-session-id
<b>Description</b>	Redundancy invalid object.
<b>Log Module</b>	subsMgmt
<b>Log Group</b>	redundancy
<b>Severity</b>	debug
<b>Recommended Actions</b>	No action required.

<b>Log ID</b>	SUBSMGMT_RD_INVALID_EVENT
<b>Message</b>	Invalid event on redundancy session %s, %s
<b>Description</b>	Redundancy invalid event.
<b>Log Module</b>	subsMgmt
<b>Log Group</b>	redundancy
<b>Severity</b>	debug
<b>Recommended Actions</b>	No action required.

<b>Log ID</b>	SUBSMGMT_RD_SUBSCRIBER_EVENT
<b>Message</b>	Event for subscriber %s on redundancy session %s %s
<b>Description</b>	Redundancy subscriber event.
<b>Log Module</b>	subsMgmt
<b>Log Group</b>	redundancy
<b>Severity</b>	debug
<b>Recommended Actions</b>	No action required.

<b>Log ID</b>	SUBSMGMT_RD_ADD_FAILED
<b>Message</b>	Failed to add subscriber %s for redundancy session %s
<b>Description</b>	Failure in redundancy sync.
<b>Log Module</b>	subsMgmt
<b>Log Group</b>	redundancy
<b>Severity</b>	debug
<b>Recommended Actions</b>	No action required.

<b>Log ID</b>	SUBSMGMT_RD_OBJECT_VALIDATION_FAILED
<b>Message</b>	Object validation failed for subscriber %s in redundancy session %s due to %s
<b>Description</b>	Redundancy invalid object.
<b>Log Module</b>	subsMgmt
<b>Log Group</b>	redundancy
<b>Severity</b>	debug
<b>Recommended Actions</b>	No action required.

<b>Log ID</b>	SUBSMGMT_FRAMED_ROUTE
<b>Message</b>	Framed route error for subscriber %s due to %s
<b>Description</b>	Error in RADIUS framed route handling.
<b>Log Module</b>	subsMgmt
<b>Log Group</b>	radius
<b>Severity</b>	notice
<b>Recommended Actions</b>	No action required.

<b>Log ID</b>	SUBSMGMT_LI_SUBSCRIBER_NOT_FOUND
<b>Message</b>	Subscriber %s not found, Lawful Intercept request is aborted
<b>Description</b>	The lawful intercept subscriber has not been found.



<b>Log Module</b>	subsMgmt
<b>Log Group</b>	lawful-intercept
<b>Severity</b>	info
<b>Recommended Actions</b>	No action required.

<b>Log ID</b>	SUBSMGMT_LI_IFL_NOT_FOUND
<b>Message</b>	Subscriber IFL not found for %s , Lawful Intercept request is aborted
<b>Description</b>	The lawful intercept subscriber IFL has not been found.
<b>Log Module</b>	subsMgmt
<b>Log Group</b>	lawful-intercept
<b>Severity</b>	info
<b>Recommended Actions</b>	No action required.

<b>Log ID</b>	SUBSMGMT_LI_INVALID_ATTRIBUTE
<b>Message</b>	Invalid Lawful Intercept attribute %s for subscriber %s
<b>Description</b>	Subscriber Lawful Intercept error.
<b>Log Module</b>	subsMgmt
<b>Log Group</b>	lawful-intercept
<b>Severity</b>	info
<b>Recommended Actions</b>	No action required.

<b>Log ID</b>	SUBSMGMT_LI_REQUEST_FAILURE
<b>Message</b>	Failed to process the Lawful Intercept request for subscriber %s
<b>Description</b>	Subscriber Lawful Intercept error.
<b>Log Module</b>	subsMgmt
<b>Log Group</b>	lawful-intercept
<b>Severity</b>	debug

<b>Recommended Actions</b>	No action required.
----------------------------	---------------------

<b>Log ID</b>	SUBSMGMT_LI_DECRYPTION_FAILED
<b>Message</b>	RADIUS Lawful Intercept request attribute %s decryption failed %s for subscriber %s
<b>Description</b>	Subscriber Lawful Intercept error.
<b>Log Module</b>	subsMgmt
<b>Log Group</b>	lawful-intercept
<b>Severity</b>	info
<b>Recommended Actions</b>	No action required.

<b>Log ID</b>	SUBSMGMT_LI_MISSING_SUBSCRIBER_ID
<b>Message</b>	Mandatory subscriber_id is missing, Lawful Intercept request is aborted
<b>Description</b>	Subscriber Lawful Intercept error.
<b>Log Module</b>	subsMgmt
<b>Log Group</b>	lawful-intercept
<b>Severity</b>	info
<b>Recommended Actions</b>	No action required.

<b>Log ID</b>	SUBSMGMT_LI_BDS_OBJECT_ADD_ERROR
<b>Message</b>	Failed to add BDS object to table %s
<b>Description</b>	Failed to add BDS object to the table.
<b>Log Module</b>	subsMgmt
<b>Log Group</b>	lawful-intercept
<b>Severity</b>	debug
<b>Recommended Actions</b>	No action required.

<b>Log ID</b>	SUBSMGMT_LI_BDS_OBJECT_DEL_ERROR
<b>Message</b>	Failed to delete BDS object from table %s
<b>Description</b>	Failed to delete BDS object from table.
<b>Log Module</b>	subsMgmt
<b>Log Group</b>	lawful-intercept
<b>Severity</b>	debug
<b>Recommended Actions</b>	No action required.

### Access\_serviced Log Messages

<b>Log ID</b>	HTTPRD_TCP_INFO
<b>Message</b>	Httpprd TCP Info[%s]: src-ip %s, src-port %s, dst-ip %s, dst-port %s
<b>Description</b>	HTTPRD TCP parameters.
<b>Log Module</b>	access_serviced
<b>Log Group</b>	general
<b>Severity</b>	debug
<b>Recommended Action</b>	Contact Rtbrick customer support

<b>Log ID</b>	HTTPRD_REDIRECT_INFO
<b>Message</b>	Httpprd redirect Info: src-ip %s, src-port %s, dst-ip %s, dst-port %s, redirect URL %s
<b>Description</b>	HTTPRD redirect information.
<b>Log Module</b>	access_serviced
<b>Log Group</b>	general
<b>Severity</b>	debug
<b>Recommended Action</b>	Contact Rtbrick customer support

<b>Log ID</b>	HTTPRD_ERROR_SUBSCRIBER_IFL_MISSING
---------------	-------------------------------------

<b>Message</b>	[%s]Subscriber ifl Missing
<b>Description</b>	Subscriber IFL is missing.
<b>Log Module</b>	access_serviced
<b>Log Group</b>	general
<b>Severity</b>	error
<b>Recommended Action</b>	Contact Rtbrick customer support

<b>Log ID</b>	HTTPRD_ERROR_SERVER_INIT_FAILED
<b>Message</b>	LWIP server initialization failed for instance %s
<b>Description</b>	LWIP server initialization failure.
<b>Log Module</b>	access_serviced
<b>Log Group</b>	general
<b>Severity</b>	error
<b>Recommended Action</b>	Contact Rtbrick customer support

<b>Log ID</b>	HTTPRD_ERROR_OBJECT_ADD
<b>Message</b>	Failed to add object. (Table Name:%s)
<b>Description</b>	HTTPRD failed to add object.
<b>Log Module</b>	access_serviced
<b>Log Group</b>	general
<b>Severity</b>	error
<b>Recommended Action</b>	Contact Rtbrick customer support

<b>Log ID</b>	HTTPRD_ERROR_OBJECT_DEL
<b>Message</b>	Failed to delete object. (Table Name:%s)
<b>Description</b>	HTTPRD failed to delete object.
<b>Log Module</b>	access_serviced
<b>Log Group</b>	general

<b>Severity</b>	error
<b>Recommended Action</b>	Contact Rtbrick customer support

<b>Log ID</b>	HTTPRD_ERROR_OBJECT_GET
<b>Message</b>	Failed to get object. (Table Name:%s)
<b>Description</b>	HTTPRD failed to get object
<b>Log Module</b>	access_serviced
<b>Log Group</b>	general
<b>Severity</b>	error
<b>Recommended Action</b>	Contact Rtbrick customer support

<b>Log ID</b>	HTTPRD_ERROR_TABLE_CREATE
<b>Message</b>	Failed to create table. (Table Name:%s)
<b>Description</b>	HTTPRD failed to create table.
<b>Log Module</b>	access_serviced
<b>Log Group</b>	general
<b>Severity</b>	error
<b>Recommended Action</b>	Contact Rtbrick customer support

<b>Log ID</b>	HTTPRD_ERROR_OBJECT_TEMPLATE
<b>Message</b>	Failed to get object template. (Object Name:%s)
<b>Description</b>	HTTPRD failed to get object template
<b>Log Module</b>	access_serviced
<b>Log Group</b>	general
<b>Severity</b>	error
<b>Recommended Action</b>	Contact Rtbrick customer support

<b>Log ID</b>	HTTPRD_ERROR_OBJECT_TEMPLATE_POPULATE
---------------	---------------------------------------

<b>Message</b>	Failed to populate object template. (Object Name:%s)
<b>Description</b>	HTTPRD failed to populate object template.
<b>Log Module</b>	access_serviced
<b>Log Group</b>	general
<b>Severity</b>	error
<b>Recommended Action</b>	Contact Rtbrick customer support

<b>Log ID</b>	HTTPRD_ERROR_OBJECT_EXTRACT
<b>Message</b>	Failed to extract object template. (Object Name:%s)
<b>Description</b>	HTTPRD failed to extract object template.
<b>Log Module</b>	access_serviced
<b>Log Group</b>	general
<b>Severity</b>	error
<b>Recommended Action</b>	Contact Rtbrick customer support

<b>Log ID</b>	HTTPRD_ERROR_TABLE_GET
<b>Message</b>	Failed to get table. (Table Name:%s)
<b>Description</b>	HTTPRD failed to get table.
<b>Log Module</b>	access_serviced
<b>Log Group</b>	general
<b>Severity</b>	error
<b>Action</b>	Contact Rtbrick customer support

## L2TP Log Messages

<b>Log ID</b>	L2TP_PACKET_RECEIVE_ERROR
<b>Message</b>	Failed to receive L2TP packet from SHM
<b>Description</b>	L2TP packet receive error
<b>Log Module</b>	l2tp

<b>Log Group</b>	general
<b>Severity</b>	debug
<b>Recommended Action</b>	Contact Rtbrick customer support

<b>Log ID</b>	L2TP_INVALID_PACKET_RECEIVED
<b>Message</b>	L2TP invalid packet %s received from %s
<b>Description</b>	L2TP invalid packet received
<b>Log Module</b>	l2tp
<b>Log Group</b>	general
<b>Severity</b>	debug
<b>Recommended Action</b>	Contact Rtbrick customer support

<b>Log ID</b>	L2TP_SUBSCRIBER_RESULT_ERROR
<b>Message</b>	L2TP subscriberd result not found for tunnel %s with session %s for subscriber %s
<b>Description</b>	Generic L2TP subscriber result error
<b>Log Module</b>	l2tp
<b>Log Group</b>	subscriber
<b>Severity</b>	debug
<b>Recommended Action</b>	Contact Rtbrick customer support

<b>Log ID</b>	L2TP_RADIUS_TUNNEL
<b>Message</b>	L2TP error in RADIUS tunnel definition for subscriber %s
<b>Description</b>	L2TP error in RADIUS tunnel definition
<b>Log Module</b>	l2tp
<b>Log Group</b>	subscriber
<b>Severity</b>	debug
<b>Recommended Action</b>	Contact Rtbrick customer support

<b>Log ID</b>	L2TP_NO_TUNNEL_POOL
<b>Message</b>	L2TP no tunnel pool for subscriber %s
<b>Description</b>	L2TP no tunnel pool for subscriber
<b>Log Module</b>	l2tp
<b>Log Group</b>	subscriber
<b>Severity</b>	debug
<b>Recommended Action</b>	Contact Rtbrick customer support

<b>Log ID</b>	L2TP_POOL_NOT_FOUND
<b>Message</b>	L2TP pool %s not found for subscriber %s
<b>Description</b>	L2TP pool error for subscriber
<b>Log Module</b>	l2tp
<b>Log Group</b>	subscriber
<b>Severity</b>	debug
<b>Recommended Action</b>	Contact Rtbrick customer support

<b>Log ID</b>	L2TP_TUNNEL_CREDENTIAL
<b>Message</b>	L2TP tunnel with missing %s for subscriber %s
<b>Description</b>	L2TP tunnel with missing credentials
<b>Log Module</b>	l2tp
<b>Log Group</b>	subscriber
<b>Severity</b>	debug
<b>Recommended Action</b>	Contact Rtbrick customer support

<b>Log ID</b>	L2TP_TUNNEL_SEND
<b>Message</b>	L2TP tunnel sent for tunnel %s type %s
<b>Description</b>	L2TP tunnel packet send
<b>Log Module</b>	l2tp



<b>Log Group</b>	tunnel
<b>Severity</b>	debug
<b>Recommended Action</b>	Contact Rtbrick customer support

<b>Log ID</b>	L2TP_TX_QUEUE_ADDED
<b>Message</b>	L2TP tunnel %s packet %s added to TX queue
<b>Description</b>	L2TP packet added to tunnel TX queue
<b>Log Module</b>	l2tp
<b>Log Group</b>	tunnel
<b>Severity</b>	debug
<b>Recommended Action</b>	Contact Rtbrick customer support

<b>Log ID</b>	L2TP_TX_QUEUE_ADD_FAILED
<b>Message</b>	L2TP tunnel %s failed to add packet to TX queue
<b>Description</b>	Failed to add L2TP packet to tunnel TX queue.
<b>Log Module</b>	l2tp
<b>Log Group</b>	tunnel
<b>Severity</b>	debug
<b>Recommended Action</b>	Contact Rtbrick customer support

<b>Log ID</b>	L2TP_TUNNEL_PACKET_SEND
<b>Message</b>	L2TP tunnel %s trying to send outstanding type %s ns %s nr %s pnr %s cw %s
<b>Description</b>	L2TP tunnel packet send
<b>Log Module</b>	l2tp
<b>Log Group</b>	tunnel
<b>Severity</b>	debug
<b>Recommended Action</b>	Contact Rtbrick customer support

<b>Log ID</b>	L2TP_TUNNEL_PACKET_RECEIVED
<b>Message</b>	L2TP %s received for tunnel %s
<b>Description</b>	L2TP tunnel packet received
<b>Log Module</b>	l2tp
<b>Log Group</b>	tunnel
<b>Severity</b>	debug
<b>Recommended Action</b>	Contact Rtbrick customer support

<b>Log ID</b>	L2TP_TUNNEL_MAX_RETRANSMISSION
<b>Message</b>	L2TP tunnel %s exceeds transmission
<b>Description</b>	L2TP tunnel exceeds transmission.
<b>Log Module</b>	l2tp
<b>Log Group</b>	tunnel
<b>Severity</b>	debug
<b>Recommended Action</b>	Contact Rtbrick customer support

<b>Log ID</b>	L2TP_OUT_OF_ORDER_PACKET
<b>Message</b>	L2TP out of order packet accepted for tunnel %s
<b>Description</b>	L2TP out of order packet
<b>Log Module</b>	l2tp
<b>Log Group</b>	tunnel
<b>Severity</b>	debug
<b>Recommended Action</b>	Contact Rtbrick customer support

<b>Log ID</b>	L2TP_SESSION_PACKET_RECEIVED
<b>Message</b>	L2TP %s received for tunnel %s session %s
<b>Description</b>	L2TP session packet received
<b>Log Module</b>	l2tp

<b>Log Group</b>	session
<b>Severity</b>	debug
<b>Recommended Action</b>	Contact Rtbrick customer support

<b>Log ID</b>	L2TP_SESSION_CREATED
<b>Message</b>	L2TP session created with tunnel %s to %s, session %s for subscriber %s
<b>Description</b>	L2TP session created
<b>Log Module</b>	l2tp
<b>Log Group</b>	subscriber
<b>Severity</b>	info
<b>Recommended Action</b>	Contact Rtbrick customer support

<b>Log ID</b>	L2TP_SESSION_FSM_STATE_CHANGE
<b>Message</b>	L2TP session %s subscriber %s, FSM state change from %s to %s for input %s with action %s
<b>Description</b>	L2TP session FSM state changed
<b>Log Module</b>	l2tp
<b>Log Group</b>	subscriber
<b>Severity</b>	info
<b>Recommended Action</b>	Contact Rtbrick customer support

<b>Log ID</b>	L2TP_SESSION_REQUEST_ADD
<b>Message</b>	L2TP session request added for subscriber %s tunnel count %s
<b>Description</b>	L2TP session request added
<b>Log Module</b>	l2tp
<b>Log Group</b>	subscriber
<b>Severity</b>	info

<b>Recommended Action</b>	Contact Rtbrick customer support
---------------------------	----------------------------------

<b>Log ID</b>	L2TP_TUNNEL_REQUEST_ADD
<b>Message</b>	L2TP tunnel request added for tunnel %s to %s
<b>Description</b>	L2TP tunnel request added
<b>Log Module</b>	l2tp
<b>Log Group</b>	tunnel
<b>Severity</b>	info
<b>Recommended Action</b>	Contact Rtbrick customer support

<b>Log ID</b>	L2TP_TUNNEL_FSM_STATE_CHANGE
<b>Message</b>	L2TP tunnel %s to %s, FSM state change from %s to %s for input %s with action %s
<b>Description</b>	L2TP tunnel FSM state changed
<b>Log Module</b>	l2tp
<b>Log Group</b>	tunnel
<b>Severity</b>	info
<b>Recommended Action</b>	Contact Rtbrick customer support

<b>Log ID</b>	L2TP_AVP_ENCODE_ERROR
<b>Message</b>	L2TP AVP encode error for tunnel %s, session %s and type %s
<b>Description</b>	L2TP AVP encode error
<b>Log Module</b>	l2tp
<b>Log Group</b>	tunnel
<b>Severity</b>	info
<b>Recommended Action</b>	Contact Rtbrick customer support

<b>Log ID</b>	L2TP_PACKET_ENCODE_ERROR
<b>Message</b>	L2TP tunnel encode error for tunnel %s to %s
<b>Description</b>	L2TP packet encode error
<b>Log Module</b>	l2tp
<b>Log Group</b>	tunnel
<b>Severity</b>	info
<b>Recommended Action</b>	Contact Rtbrick customer support

<b>Log ID</b>	L2TP_TUNNEL_DECODE_ERROR
<b>Message</b>	L2TP tunnel decode error %s with packet length %s for tunnel %s to %s
<b>Description</b>	L2TP tunnel decode error
<b>Log Module</b>	l2tp
<b>Log Group</b>	tunnel
<b>Severity</b>	info
<b>Recommended Action</b>	Contact Rtbrick customer support

<b>Log ID</b>	L2TP_TUNNEL_AVP_MH_MISMATCH
<b>Message</b>	L2TP tunnel AVP with vendor-id %s and attribute-type %s m/h bit mismatch for tunnel %s to %s
<b>Description</b>	L2TP tunnel decode error
<b>Log Module</b>	l2tp
<b>Log Group</b>	tunnel
<b>Severity</b>	info
<b>Recommended Action</b>	Contact Rtbrick customer support

<b>Log ID</b>	L2TP_PACKET_DROP
<b>Message</b>	L2TP Packet dropped due to %s packet type %s received ns %s tunnel nr %s on tunnel %s to %s and session %s

<b>Description</b>	L2TP tunnel packet dropped because duplicate or out of order
<b>Log Module</b>	l2tp
<b>Log Group</b>	tunnel
<b>Severity</b>	info
<b>Recommended Action</b>	Contact Rtbrick customer support

<b>Log ID</b>	L2TP_MBIT_UNKNOWN
<b>Message</b>	L2TP tunnel unknown mandatory AVP vendor-id %s and attribute-type %s received for tunnel %s to %s
<b>Description</b>	L2TP tunnel packet received with unknown mandatory AVP
<b>Log Module</b>	l2tp
<b>Log Group</b>	tunnel
<b>Severity</b>	info
<b>Recommended Action</b>	Contact Rtbrick customer support

<b>Log ID</b>	L2TP_AVP_DECODE_ERROR
<b>Message</b>	L2TP AVP decode error %s for vendor %s attribute-type %s for tunnel %s to %s
<b>Description</b>	L2TP AVP decode error
<b>Log Module</b>	l2tp
<b>Log Group</b>	tunnel
<b>Severity</b>	info
<b>Recommended Action</b>	Contact Rtbrick customer support

<b>Log ID</b>	L2TP_TUNNEL_AUTH_ERROR
<b>Message</b>	L2TP tunnel %s to %s authentication error %s
<b>Description</b>	L2TP tunnel authentication error.
<b>Log Module</b>	l2tp

<b>Log Group</b>	tunnel
<b>Severity</b>	info
<b>Recommended Action</b>	Contact Rtbrick customer support

<b>Log ID</b>	L2TP_TUNNEL_DELETED
<b>Message</b>	L2TP tunnel %s to %s deleted
<b>Description</b>	L2TP tunnel deleted
<b>Log Module</b>	l2tp
<b>Log Group</b>	tunnel
<b>Severity</b>	info
<b>Recommended Action</b>	Contact Rtbrick customer support

<b>Log ID</b>	L2TP_TRAP_ADD
<b>Message</b>	Failed to add I/O trap %s
<b>Description</b>	Failed to add I/O trap entry
<b>Log Module</b>	l2tp
<b>Log Group</b>	config
<b>Severity</b>	notice
<b>Recommended Action</b>	Check FIB/RIB logs

## IGMP Log Messages

<b>Message</b>	IGMP instance is UP - {instance:%s}
<b>Description</b>	IGMP instance configuration add triggered
<b>Log Module</b>	igmp
<b>Log Group</b>	config
<b>Log ID</b>	IGMP_INSTANCE_UP
<b>Severity</b>	INFO
<b>Action</b>	Check the IGMP status for this instance

<b>Message</b>	IGMP instance is DOWN - {instance:%s}
<b>Description</b>	IGMP instance configuration delete triggered
<b>Log Module</b>	igmp
<b>Log Group</b>	config
<b>Log ID</b>	IGMP_INSTANCE_DOWN
<b>Severity</b>	INFO
<b>Action</b>	Check the IGMP status for this instance

<b>Message</b>	IGMP logical interface is UP - {instance:%s logical-interface:%s}
<b>Description</b>	IGMP logical interface configuration add or dynamic subscriber ifl creation triggered
<b>Log Module</b>	igmp
<b>Log Group</b>	config
<b>Log ID</b>	IGMP_INTERFACE_UP
<b>Severity</b>	INFO
<b>Action</b>	Check the IGMP status for this logical interface

<b>Message</b>	IGMP logical interface is DOWN - {instance:%s interface:%s}
<b>Description</b>	IGMP logical interface configuration delete or dynamic subscriber ifl deletion triggered
<b>Log Module</b>	igmp
<b>Log Group</b>	config
<b>Log ID</b>	IGMP_INTERFACE_DOWN
<b>Severity</b>	INFO
<b>Action</b>	Check the IGMP status for this logical interface



<b>Message</b>	IGMP interface role is querier - {instance:%s interface:%s}
<b>Description</b>	IGMP interface role is querier
<b>Log Module</b>	igmp
<b>Log Group</b>	igmp-interface-events
<b>Log ID</b>	IGMP_INTERFACE_ROLE_QUERIER
<b>Severity</b>	INFO
<b>Action</b>	Check the IGMP role on this logical interface

<b>Message</b>	IGMP interface role is non-querier - {instance:%s interface:%s}
<b>Description</b>	IGMP interface role is non-querier
<b>Log Module</b>	igmp
<b>Log Group</b>	igmp-interface-events
<b>Log ID</b>	IGMP_INTERFACE_ROLE_NON_QUERIER
<b>Severity</b>	INFO
<b>Action</b>	Check the IGMP role on this logical interface

<b>Message</b>	IGMP membership report is permitted - {instance:%s interface:%s} {source:%s group:%s}
<b>Description</b>	IGMP membership report is permitted
<b>Log Module</b>	igmp
<b>Log Group</b>	igmp-packet-events
<b>Log ID</b>	IGMP_INTERFACE_FILTER_MEMBERSHIP_PERMITTED
<b>Severity</b>	DEBUG
<b>Action</b>	Check if membership should be permitted

<b>Message</b>	IGMP membership report is denied by interface filter - {instance:%s interface:%s} {source:%s group:%s}
<b>Description</b>	IGMP membership report is denied
<b>Log Module</b>	igmp
<b>Log Group</b>	igmp-packet-events
<b>Log ID</b>	IGMP_INTERFACE_FILTER_MEMBERSHIP_DENIED
<b>Severity</b>	DEBUG
<b>Action</b>	Check if membership report should be denied

<b>Message</b>	IGMP membership report dropped due to max-limit reached on the interface - {instance:%s interface:%s} {source:%s group:%s}
<b>Description</b>	IGMP membership report dropped due to max-limit reached on the interface
<b>Log Module</b>	igmp
<b>Log Group</b>	igmp-packet-events
<b>Log ID</b>	IGMP_INTERFACE_MAX_LIMIT_REACHED
<b>Severity</b>	INFO
<b>Action</b>	Check if maximum members limit on this interface

<b>Message</b>	IGMP general query sent on the interface - {instance:%s interface:%s}
<b>Description</b>	IGMP general query sent on the interface
<b>Log Module</b>	igmp
<b>Log Group</b>	igmp-packet-events
<b>Log ID</b>	IGMP_INTERFACE_GENERAL_QUERY_SENT
<b>Severity</b>	DEBUG
<b>Action</b>	Check if general query out statistics on the interface

<b>Message</b>	IGMP general query received on the interface - {instance:%s interface:%s}
<b>Description</b>	IGMP general query received on the interface
<b>Log Module</b>	igmp
<b>Log Group</b>	igmp-packet-events
<b>Log ID</b>	IGMP_INTERFACE_GENERAL_QUERY_RECEIVED
<b>Severity</b>	DEBUG
<b>Action</b>	Check if general query in statistics on the interface

<b>Message</b>	IGMP group query sent on the interface - {instance:%s interface:%s} {group:%s}
<b>Description</b>	IGMP group query sent on the interface
<b>Log Module</b>	igmp
<b>Log Group</b>	igmp-packet-events
<b>Log ID</b>	IGMP_INTERFACE_GROUP_QUERY_SENT
<b>Severity</b>	DEBUG
<b>Action</b>	Check if group query out statistics on the interface

<b>Message</b>	IGMP group query received on the interface - {instance:%s interface:%s} {group:%s}
<b>Description</b>	IGMP group query received on the interface
<b>Log Module</b>	igmp
<b>Log Group</b>	igmp-packet-events
<b>Log ID</b>	IGMP_INTERFACE_GROUP_QUERY_RECEIVED
<b>Severity</b>	DEBUG
<b>Action</b>	Check if group query in statistics on the interface

<b>Message</b>	IGMP membership join received on the interface - {instance:%s interface:%s} {source:%s group:%s}
<b>Description</b>	IGMP membership join received on the interface
<b>Log Module</b>	igmp
<b>Log Group</b>	igmp-packet-events
<b>Log ID</b>	IGMP_INTERFACE_MEMBERSHIP_JOIN_RECEIVED
<b>Severity</b>	DEBUG
<b>Action</b>	Check if IGMP membership join received on the interface

<b>Message</b>	IGMP membership leave received on the interface - {instance:%s interface:%s} {source:%s group:%s}
<b>Description</b>	IGMP membership leave received on the interface
<b>Log Module</b>	igmp
<b>Log Group</b>	igmp-packet-events
<b>Log ID</b>	IGMP_INTERFACE_MEMBERSHIP_LEAVE_RECEIVED
<b>Severity</b>	DEBUG
<b>Action</b>	Check if IGMP membership leave received on the interface

<b>Message</b>	IGMP membership is added - {instance:%s interface:%s} {source:%s group:%s type:%s}
<b>Description</b>	IGMP membership is added
<b>Log Module</b>	igmp
<b>Log Group</b>	igmp-membership-events
<b>Log ID</b>	IGMP_MEMBERSHIP_ADD
<b>Severity</b>	DEBUG
<b>Action</b>	Check if membership should be permitted

<b>Message</b>	IGMP membership is deleted - {instance:%s interface:%s} {source:%s group:%s type:%s}
<b>Description</b>	IGMP membership is deleted
<b>Log Module</b>	igmp
<b>Log Group</b>	igmp-membership-events
<b>Log ID</b>	IGMP_MEMBERSHIP_DELETE
<b>Severity</b>	DEBUG
<b>Action</b>	Check if IGMP leave received or static join removed

<b>Message</b>	IGMP mroute added to fiblocal table - {instance:%s interface:%s} {source:%s group:%s type:%s}
<b>Description</b>	IGMP mroute added to fiblocal table
<b>Log Module</b>	igmp
<b>Log Group</b>	igmp-route-events
<b>Log ID</b>	IGMP_FIBLOCAL_ADD
<b>Severity</b>	DEBUG
<b>Action</b>	Check if IGMP route added to fiblocal table

<b>Message</b>	IGMP mroute deleted to fiblocal table - {instance:%s interface:%s} {source:%s group:%s type:%s}
<b>Description</b>	IGMP mroute deleted from fiblocal table
<b>Log Module</b>	igmp
<b>Log Group</b>	igmp-route-events
<b>Log ID</b>	IGMP_FIBLOCAL_DELETE
<b>Severity</b>	DEBUG
<b>Action</b>	Check if IGMP mroute deleted from fiblocal table

## PIM Log Messages

<b>Log ID</b>	PIM_INSTANCE_UP
<b>Message</b>	PIM Instance (%s) is Up
<b>Description</b>	PIM Instance Events
<b>Log Module</b>	PIM
<b>Log Group</b>	instance
<b>Severity</b>	INFO
<b>Recommended Action</b>	Contact Rtbrick customer support

<b>Log ID</b>	PIM_INSTANCE_DOWN
<b>Message</b>	PIM Instance (%s) is Down
<b>Description</b>	PIM Instance Events
<b>Log Module</b>	PIM
<b>Log Group</b>	instance
<b>Severity</b>	ERROR
<b>Recommended Action</b>	Contact Rtbrick customer support

<b>Log ID</b>	PIM_INTERFACE_UP
<b>Message</b>	PIM Interface (%s) is Up on Instance (%s)
<b>Description</b>	PIM Interface Events
<b>Log Module</b>	PIM
<b>Log Group</b>	interface
<b>Severity</b>	INFO
<b>Recommended Action</b>	Contact Rtbrick customer support

<b>Log ID</b>	PIM_INTERFACE_DOWN
---------------	--------------------

<b>Message</b>	PIM Interface (%s) is Down on Instance (%s)
<b>Description</b>	PIM Interface Events
<b>Log Module</b>	PIM
<b>Log Group</b>	interface
<b>Severity</b>	INFO
<b>Recommended Action</b>	Contact Rtbrick customer support

<b>Log ID</b>	PIM_NEIGHBOR_UP
<b>Message</b>	PIM Neighbor (%s) is Up on Interface (%s), Instance (%s)
<b>Description</b>	PIM Neighbor Events
<b>Log Module</b>	PIM
<b>Log Group</b>	neighbor
<b>Severity</b>	INFO
<b>Recommended Action</b>	Contact Rtbrick customer support

<b>Log ID</b>	PIM_NEIGHBOR_DOWN
<b>Message</b>	PIM Neighbor (%s) is Down on Interface (%s), Instance (%s)
<b>Description</b>	PIM Neighbor Events
<b>Log Module</b>	PIM
<b>Log Group</b>	neighbor
<b>Severity</b>	ERROR
<b>Recommended Action</b>	Contact Rtbrick customer support

<b>Log ID</b>	PIM_DR_ELECTION_WON
<b>Message</b>	DR election won new DR (%s) elected on Interface (%s), Instance (%s)
<b>Description</b>	PIM DR election Events
<b>Log Module</b>	PIM

<b>Log Group</b>	dr-election
<b>Severity</b>	INFO
<b>Recommended Action</b>	Contact Rtbrick customer support

<b>Log ID</b>	PIM_DR_ELECTION_LOST
<b>Message</b>	DR election lost new DR (%s) elected on Interface (%s), Instance (%s)
<b>Description</b>	PIM DR election Events
<b>Log Module</b>	PIM
<b>Log Group</b>	dr-election
<b>Severity</b>	INFO
<b>Recommended Action</b>	Contact Rtbrick customer support

<b>Log ID</b>	PIM_PACKET_SEND
<b>Message</b>	Sending (%s) Packet with Length %s on Instance (%s) Interface (%s) from (%s) to (%s)
<b>Description</b>	PIM Packet Send Events
<b>Log Module</b>	PIM
<b>Log Group</b>	packet
<b>Severity</b>	INFO
<b>Recommended Action</b>	Contact Rtbrick customer support

<b>Log ID</b>	PIM_PACKET_RECEIVE
<b>Message</b>	Receiving (%s) Packet with Length %s on Instance (%s) Interface (%s) from (%s) to (%s)
<b>Description</b>	PIM Packet Receive Events
<b>Log Module</b>	PIM
<b>Log Group</b>	packet
<b>Severity</b>	INFO



<b>Recommended Action</b>	Contact Rtbrick customer support
---------------------------	----------------------------------

<b>Log ID</b>	PIM_OBJECT_TRACE
<b>Message</b>	Dumping Object (%s)%s:%s %s
<b>Description</b>	PIM Object Operation Dump
<b>Log Module</b>	PIM
<b>Log Group</b>	object-trace
<b>Severity</b>	DEBUG
<b>Recommended Action</b>	Contact Rtbrick customer support

<b>Log ID</b>	PIM_ERROR_LOG
<b>Message</b>	PIM Error Reason (%s)
<b>Description</b>	PIM Error Reason
<b>Log Module</b>	PIM
<b>Log Group</b>	error-log
<b>Severity</b>	ERROR
<b>Recommended Action</b>	Contact Rtbrick customer support

<b>Log ID</b>	PIM_INFO_LOG
<b>Message</b>	PIM Info (%s)
<b>Description</b>	PIM Information.
<b>Log Module</b>	PIM
<b>Log Group</b>	info-log
<b>Severity</b>	INFO
<b>Recommended Action</b>	Contact Rtbrick customer support

<b>Message</b>	PIM mroute added to ribin table - {instance:%s interface:%s} {source:%s group:%s source:%s sub-source:%s}
----------------	---

<b>Description</b>	PIM mroute added to ribin table
<b>Log Module</b>	PIM
<b>Log Group</b>	multicast-route
<b>Log ID</b>	PIM_RIBIN_ROUTE_ADD
<b>Severity</b>	DEBUG
<b>Recommended Action</b>	Check if PIM route is added to the 'ribin' table.

<b>Log ID</b>	PIM_RIBIN_ROUTE_CHANGE
<b>Message</b>	PIM mroute changed to ribin table - {instance:%s interface:%s} {source:%s group:%s source:%s sub-source:%s}
<b>Description</b>	PIM mroute changed to the 'ribin' table.
<b>Log Module</b>	PIM
<b>Log Group</b>	multicast-route
<b>Severity</b>	DEBUG
<b>Recommended Action</b>	Check if PIM route changed to ribin table.

<b>Log ID</b>	PIM_RIBIN_ROUTE_DELETE
<b>Message</b>	PIM mroute deleted to ribin table - {instance:%s interface:%s} {source:%s group:%s source:%s sub-source:%s}
<b>Description</b>	PIM mroute deleted to the 'ribin' table.
<b>Log Module</b>	PIM
<b>Log Group</b>	multicast-route
<b>Severity</b>	DEBUG
<b>Recommended Action</b>	Check if PIM route deleted to the 'ribin' table.

<b>Log ID</b>	PIM_ADDRESS_RESOLUTION_REQUEST_ADD
<b>Message</b>	PIM RPF address resolution requested - {instance:%s address:%s} {afi:%s safi:%s}
<b>Description</b>	PIM RPF address resolution requested

<b>Log Module</b>	PIM
<b>Log Group</b>	rpf
<b>Severity</b>	DEBUG
<b>Recommended Action</b>	Check requested address has resolvable route

<b>Log ID</b>	PIM_ADDRESS_RESOLUTION_REQUEST_DELETE
<b>Message</b>	PIM RPF address resolution request deleted - {instance:%s address:%s} {afi:%s safi:%s}
<b>Description</b>	PIM RPF address resolution request has been deleted.
<b>Log Module</b>	PIM
<b>Log Group</b>	rpf
<b>Severity</b>	DEBUG
<b>Recommended Action</b>	Check if no multicast route with requested address

<b>Log ID</b>	PIM_ADDRESS_RESOLUTION_RESPONSE_ADD
<b>Message</b>	PIM RPF address resolution received - {instance:%s address:%s} {afi:%s safi:%s} {exit-interface:%s peer-ip:%s}
<b>Description</b>	PIM RPF address resolution received.
<b>Log Module</b>	PIM
<b>Log Group</b>	rpf
<b>Severity</b>	DEBUG
<b>Recommended Action</b>	Verify if resolved address is reachable.

<b>Log ID</b>	PIM_ADDRESS_RESOLUTION_RESPONSE_CHANGE
<b>Message</b>	PIM RPF resolved address changed - {instance:%s address:%s} {afi:%s safi:%s} {exit-interface:%s peer-ip:%s}
<b>Description</b>	PIM RPF resolved address changed.
<b>Log Module</b>	PIM
<b>Log Group</b>	rpf

<b>Severity</b>	DEBUG
<b>Recommended Action</b>	Check if resolved address in reachable.

<b>Log ID</b>	PIM_ADDRESS_RESOLUTION_RESPONSE_DELETE
<b>Message</b>	PIM RPF resolved address deleted - {instance:%s address:%s} {afi:%s safi:%s} {exit-interface:%s peer-ip:%s}
<b>Description</b>	PIM RPF resolved address has been deleted.
<b>Log Module</b>	PIM
<b>Log Group</b>	rpf
<b>Severity</b>	DEBUG
<b>Recommended Action</b>	Check if resolved address in reachable.

<b>Log ID</b>	PIM_RIBLOCAL_ROUTE_ADD
<b>Message</b>	PIM multicast route added to riblocal table - {instance:%s interface:%s} {source:%s group:%s rpf-interface:%s}
<b>Description</b>	PIM multicast route added to the 'riblocal' table.
<b>Log Module</b>	PIM
<b>Log Group</b>	multicast-route
<b>Severity</b>	DEBUG
<b>Recommended Action</b>	Check if installed multicast route has subscribers.

<b>Log ID</b>	PIM_RIBLOCAL_ROUTE_DELETE
<b>Message</b>	PIM multicast route deleted to riblocal table - {instance:%s interface:%s} {source:%s group:%s rpf-interface:%s}
<b>Description</b>	PIM multicast route deleted to the 'riblocal' table.
<b>Log Module</b>	PIM
<b>Log Group</b>	multicast-route
<b>Severity</b>	DEBUG

<b>Recommended Action</b>	Check if multicast route has no subscribers.
---------------------------	--

<b>Log ID</b>	PIM_RIBLOCAL_ROUTE_CHANGE
<b>Message</b>	PIM multicast route changed to riblocal table - {instance:%s interface:%s} {source:%s group:%s rpf-interface:%s}
<b>Description</b>	PIM multicast route changed to the 'riblocal' table.
<b>Log Module</b>	PIM
<b>Log Group</b>	multicast-route
<b>Severity</b>	DEBUG
<b>Recommended Action</b>	Check if multicast route has no subscribers.

<b>Log ID</b>	PIM_FIBLOCAL_ROUTE_ADD
<b>Message</b>	PIM multicast route added to fiblocal table - {instance:%s} {source:%s group:%s rpf-interface:%s}
<b>Description</b>	PIM multicast route added to fiblocal table
<b>Log Module</b>	PIM
<b>Log Group</b>	multicast-route
<b>Severity</b>	DEBUG
<b>Recommended Action</b>	Check if installed multicast route has subscribers.

<b>Log ID</b>	PIM_FIBLOCAL_ROUTE_DELETE
<b>Message</b>	PIM multicast route deleted to fiblocal table - {instance:%s} {source:%s group:%s rpf-interface:%s}
<b>Description</b>	PIM multicast route deleted to fiblocal table
<b>Log Module</b>	PIM
<b>Log Group</b>	multicast-route
<b>Severity</b>	DEBUG
<b>Recommended Action</b>	Check if multicast route has no subscribers.

<b>Log ID</b>	PIM_FIBLOCAL_ROUTE_CHANGE
<b>Message</b>	PIM multicast route changed to fiblocal table - {instance:%s} {source:%s group:%s rpf-interface:%s}
<b>Description</b>	PIM multicast route changed to fiblocal table
<b>Log Module</b>	PIM
<b>Log Group</b>	multicast-route
<b>Severity</b>	DEBUG
<b>Recommended Action</b>	Check if multicast route has no subscribers.

<b>Log ID</b>	PIM_JOIN_SENT
<b>Message</b>	PIM join sent for multicast route - {instance:%s interface:%s} {source:%s group:%s}
<b>Description</b>	PIM join sent for multicast route
<b>Log Module</b>	PIM
<b>Log Group</b>	join-prune
<b>Severity</b>	INFO
<b>Recommended Action</b>	Check if PIM join received at upstream router.

<b>Log ID</b>	PIM_PRUNE_SENT
<b>Message</b>	PIM prune sent for multicast route - {instance:%s interface:%s} {source:%s group:%s}
<b>Description</b>	PIM prune sent for multicast route
<b>Log Module</b>	PIM
<b>Log Group</b>	join-prune
<b>Severity</b>	INFO
<b>Recommended Action</b>	Check if PIM prune received at upstream router.

## Resource Monitoring Log Messages

<b>Log ID</b>	RESMON_GENERIC
<b>Message</b>	RESMOND generic event - %s
<b>Description</b>	Resmond generic event logging
<b>Log Module</b>	RESMON
<b>Log Group</b>	resmon-internal-events
<b>Severity</b>	DEBUG
<b>Recommended Action</b>	Check resmond resource and internal tables

<b>Log ID</b>	RESMON_GENERIC_RC
<b>Message</b>	RESMOND generic event - %s status[%s - %s]
<b>Description</b>	Resmond generic event logging
<b>Log Module</b>	RESMON
<b>Log Group</b>	resmon-internal-events
<b>Severity</b>	DEBUG
<b>Recommended Action</b>	Check resmond resource and intenal tables

<b>Log ID</b>	RESMON_BDS_OBJ_ALLOC_ERR
<b>Message</b>	Unable to allocate object template for %s
<b>Description</b>	Resmond bds event logging
<b>Log Module</b>	RESMON
<b>Log Group</b>	resmon-bds-events
<b>Severity</b>	DEBUG
<b>Recommended Action</b>	Check resmond resource and intenal tables

<b>Log ID</b>	RESMON_BDS_ATTR_NOT_FOUND
<b>Message</b>	Expecting attribute "%s", but not found
<b>Description</b>	Resmond bds event logging
<b>Log Module</b>	RESMON

<b>Log Group</b>	resmon-bds-events
<b>Severity</b>	DEBUG
<b>Recommended Action</b>	Check resmond resource and intenal tables

<b>Log ID</b>	RESMON_BDS_ATTR_OBJ_NOT_FOUND
<b>Message</b>	Unable to get attribute "%s" in "%s"
<b>Description</b>	Resmond bds event logging
<b>Log Module</b>	RESMON
<b>Log Group</b>	resmon-bds-events
<b>Severity</b>	DEBUG
<b>Recommended Action</b>	Check resmond resource and intenal tables

<b>Log ID</b>	RESMON_BDS_TABLE_NOT_FOUND
<b>Message</b>	Table "%s" not present
<b>Description</b>	Resmond bds event logging
<b>Log Module</b>	RESMON
<b>Log Group</b>	resmon-bds-events
<b>Severity</b>	DEBUG
<b>Recommended Action</b>	Check resmond resource and internal tables.

<b>Log ID</b>	RESMON_BDS_TBL_CREATE_ERR
<b>Message</b>	Failed to create table %s of type %s
<b>Description</b>	Resmond bds event logging
<b>Log Module</b>	RESMON
<b>Log Group</b>	resmon-bds-events
<b>Severity</b>	DEBUG
<b>Recommended Action</b>	Check resmond resource and internal tables.



<b>Log ID</b>	RESMON_BDS_TBL_SUBSCRIBE_ERR
<b>Message</b>	Failed to subscribe table %s
<b>Description</b>	Resmond bds event logging
<b>Log Module</b>	RESMON
<b>Log Group</b>	resmon-bds-events
<b>Severity</b>	DEBUG
<b>Recommended Action</b>	Check resmond resource and intenal tables

<b>Log ID</b>	RESMON_INTERNAL_FILE_OPEN_ERR
<b>Message</b>	File %s open failed[%s - %s]
<b>Description</b>	Resmond internal event logging
<b>Log Module</b>	RESMON
<b>Log Group</b>	resmon-internal-events
<b>Severity</b>	DEBUG
<b>Recommended Action</b>	Check resmond resource and intenal tables

<b>Log ID</b>	RESMON_INTERNAL_FILE_CLOSE_ERR
<b>Message</b>	File %s open failed[%s - %s]
<b>Description</b>	Resmond internal event logging
<b>Log Module</b>	RESMON
<b>Log Group</b>	resmon-internal-events
<b>Severity</b>	DEBUG
<b>Recommended Action</b>	Check resmond resource and intenal tables

<b>Log ID</b>	RESMON_INTERNAL_FILE_NOT_FOUND
<b>Message</b>	File %s not found
<b>Description</b>	Resmond internal event logging
<b>Log Module</b>	RESMON

<b>Log Group</b>	resmon-internal-events
<b>Severity</b>	DEBUG
<b>Recommended Action</b>	Check resmond resource and intenal tables

<b>Log ID</b>	RESMON_INTERNAL_CMD_EXEC_FAIL
<b>Message</b>	Failed to execute system cmd[%s], err code[%s]
<b>Description</b>	Resmond internal event logging
<b>Log Module</b>	RESMON
<b>Log Group</b>	resmon-internal-events
<b>Severity</b>	DEBUG
<b>Recommended Action</b>	Check resmond resource and intenal tables

<b>Log ID</b>	RESMON_RESOURCE_OPTICS_MDL_TEMP_HIGH_ALARM
<b>Message</b>	Module temperature is above threshold high alarm for module %s
<b>Description</b>	Resmond resource event logging
<b>Log Module</b>	RESMON
<b>Log Group</b>	resmon-resource-events
<b>Severity</b>	INFO
<b>Recommended Action</b>	Check resource properties

<b>Log ID</b>	RESMON_RESOURCE_OPTICS_MDL_TEMP_HIGH_WARN
<b>Message</b>	Module temperature is above threshold high warning for module %s
<b>Description</b>	Resmond resource event logging
<b>Log Module</b>	RESMON
<b>Log Group</b>	resmon-resource-events
<b>Severity</b>	INFO

<b>Recommended Action</b>	Check resource properties
---------------------------	---------------------------

<b>Log ID</b>	RESMON_RESOURCE_OPTICS_MDL_TEMP_LOW_ALARM
<b>Message</b>	Module temperature is below threshold low alarm for module %s
<b>Description</b>	Resmond resource event logging
<b>Log Module</b>	RESMON
<b>Log Group</b>	resmon-resource-events
<b>Severity</b>	INFO
<b>Recommended Action</b>	Check resource properties

<b>Log ID</b>	RESMON_RESOURCE_OPTICS_MDL_TEMP_LOW_WARN
<b>Message</b>	Module temperature is below threshold low warning for module %s
<b>Description</b>	Resmond resource event logging
<b>Log Module</b>	RESMON
<b>Log Group</b>	resmon-resource-events
<b>Severity</b>	INFO
<b>Recommended Action</b>	Check resource properties

<b>Log ID</b>	RESMON_RESOURCE_OPTICS_MDL_VOLTAGE_HIGH_ALARM
<b>Message</b>	Module voltage is above threshold high alarm for module %s
<b>Description</b>	Resmond resource event logging
<b>Log Module</b>	RESMON
<b>Log Group</b>	resmon-resource-events
<b>Severity</b>	INFO
<b>Recommended Action</b>	Check resource properties

<b>Log ID</b>	RESMON_RESOURCE_OPTICS_MDL_VOLTAGE_HIGH_WARN
<b>Message</b>	Module voltage is above threshold high warning for module %s
<b>Description</b>	Resmond resource event logging
<b>Log Module</b>	RESMON
<b>Log Group</b>	resmon-resource-events
<b>Severity</b>	INFO
<b>Recommended Action</b>	Check resource properties

<b>Log ID</b>	RESMON_RESOURCE_OPTICS_MDL_VOLTAGE_LOW_ALARM
<b>Message</b>	Module voltage is below threshold low alarm for module %s
<b>Description</b>	Resmond resource event logging
<b>Log Module</b>	RESMON
<b>Log Group</b>	resmon-resource-events
<b>Severity</b>	INFO
<b>Recommended Action</b>	Check resource properties

<b>Log ID</b>	RESMON_RESOURCE_OPTICS_MDL_VOLTAGE_LOW_WARN
<b>Message</b>	Module voltage is below threshold high alarm for module %s
<b>Description</b>	Resmond resource event logging
<b>Log Module</b>	RESMON
<b>Log Group</b>	resmon-resource-events
<b>Severity</b>	INFO
<b>Recommended Action</b>	Check resource properties

<b>Log ID</b>	RESMON_RESOURCE_OPTICS_MDL_LANE_POWER_HIGH_ALARM
<b>Message</b>	Module %s power is above threshold high alarm for module %s on lane %s

<b>Description</b>	Resmond resource event logging
<b>Log Module</b>	RESMON
<b>Log Group</b>	resmon-resource-events
<b>Severity</b>	INFO
<b>Recommended Action</b>	Check resource properties

<b>Log ID</b>	RESMON_RESOURCE_OPTICS_MDL_LANE_POWER_HIGH_WARN
<b>Message</b>	Module %s power is above threshold high warning for module %s on lane %s
<b>Description</b>	Resmond resource event logging
<b>Log Module</b>	RESMON
<b>Log Group</b>	resmon-resource-events
<b>Severity</b>	INFO
<b>Recommended Action</b>	Check resource properties

<b>Log ID</b>	RESMON_RESOURCE_OPTICS_MDL_LANE_POWER_LOW_ALARM
<b>Message</b>	Module %s power is below threshold low alarm for module %s on lane %s
<b>Description</b>	Resmond resource event logging
<b>Log Module</b>	RESMON
<b>Log Group</b>	resmon-resource-events
<b>Severity</b>	INFO
<b>Recommended Action</b>	Check resource properties

<b>Log ID</b>	RESMON_RESOURCE_OPTICS_MDL_LANE_POWER_LOW_WARN
<b>Message</b>	Module %s power is below threshold high alarm for module %s on lane %s

<b>Description</b>	Resmond resource event logging
<b>Log Module</b>	RESMON
<b>Log Group</b>	resmon-resource-events
<b>Severity</b>	INFO
<b>Recommended Action</b>	Check resource properties

<b>Log ID</b>	RESMON_RESOURCE_OPTICS_MDL_LANE_BIAS_HIGH_ALARM
<b>Message</b>	Module %s bias is above threshold high alarm for module %s on lane %s
<b>Description</b>	Resmond resource event logging
<b>Log Module</b>	RESMON
<b>Log Group</b>	resmon-resource-events
<b>Severity</b>	INFO
<b>Recommended Action</b>	Check resource properties

<b>Log ID</b>	RESMON_RESOURCE_OPTICS_MDL_LANE_BIAS_HIGH_WARN
<b>Message</b>	Module %s bias is above threshold high warning for module %s on lane %s
<b>Description</b>	Resmond resource event logging
<b>Log Module</b>	RESMON
<b>Log Group</b>	resmon-resource-events
<b>Severity</b>	INFO
<b>Recommended Action</b>	Check resource properties

<b>Log ID</b>	RESMON_RESOURCE_OPTICS_MDL_LANE_BIAS_LOW_ALARM
<b>Message</b>	Module %s bias is below threshold low alarm for module %s on lane %s
<b>Description</b>	Resmond resource event logging
<b>Log Module</b>	RESMON

<b>Log Group</b>	resmon-resource-events
<b>Severity</b>	INFO
<b>Recommended Action</b>	Check resource properties

<b>Log ID</b>	RESMON_RESOURCE_OPTICS_MDL_LANE_BIAS_LOW_WARN
<b>Message</b>	Module %s bias is below threshold high alarm for module %s on lane %s
<b>Description</b>	Resmond resource event logging
<b>Log Module</b>	RESMON
<b>Log Group</b>	resmon-resource-events
<b>Severity</b>	INFO
<b>Recommended Action</b>	Check resource properties

<b>Log ID</b>	RESMON_RESOURCE_OPTICS_MDL_LANE_LOS
<b>Message</b>	Module %s loss of signal alarm for module %s on lane %s
<b>Description</b>	Resmond resource event logging
<b>Log Module</b>	RESMON
<b>Log Group</b>	resmon-resource-events
<b>Severity</b>	INFO
<b>Recommended Action</b>	Check resource properties

<b>Log ID</b>	RESMON_RESOURCE_OPTICS_MDL_LANE_LOL
<b>Message</b>	Module %s loss of light alarm for module %s on lane %s
<b>Description</b>	Resmond resource event logging
<b>Log Module</b>	RESMON
<b>Log Group</b>	resmon-resource-events
<b>Severity</b>	INFO
<b>Recommended Action</b>	Check resource properties

## validation Log Messages

<b>Log ID</b>	VALIDATION_TABLE_CREATED
<b>Message</b>	BDS table %s created
<b>Description</b>	BDS table has been created.
<b>Log Module</b>	validation
<b>Log Group</b>	general
<b>Severity</b>	debug
<b>Recommended Action</b>	Contact Rtbrick customer support

<b>Log ID</b>	VALIDATION_TABLE_CREATE_ERROR
<b>Message</b>	Failed to create BDS table %s
<b>Description</b>	Failed to create the BDS table.
<b>Log Module</b>	validation
<b>Log Group</b>	general
<b>Severity</b>	debug
<b>Recommended Action</b>	Contact Rtbrick customer support

<b>Log ID</b>	VALIDATION_TABLE_DELETED
<b>Message</b>	BDS table %s deleted
<b>Description</b>	BDS table has been deleted.
<b>Log Module</b>	validation
<b>Log Group</b>	general
<b>Severity</b>	debug
<b>Recommended Action</b>	Contact Rtbrick customer support

<b>Log ID</b>	VALIDATION_TABLE_ATTR_NOT_FOUND
<b>Message</b>	Failed to get table attribute for table %s
<b>Description</b>	BDS table attribute is not found.



<b>Log Module</b>	validation
<b>Log Group</b>	general
<b>Severity</b>	debug
<b>Recommended Action</b>	Contact Rtbrick customer support

<b>Log ID</b>	VALIDATION_TABLE_NOT_FOUND
<b>Message</b>	Failed to get table %s
<b>Description</b>	BDS table is not found.
<b>Log Module</b>	validation
<b>Log Group</b>	general
<b>Severity</b>	debug
<b>Recommended Action</b>	Contact Rtbrick customer support

<b>Log ID</b>	VALIDATION_TABLE_SUBSCRIBED
<b>Message</b>	BDS table %s subscribed
<b>Description</b>	BDS table is subscribed.
<b>Log Module</b>	validation
<b>Log Group</b>	general
<b>Severity</b>	debug
<b>Recommended Action</b>	Contact Rtbrick customer support

<b>Log ID</b>	VALIDATION_TABLE_UNSUBSCRIBED
<b>Message</b>	BDS table %s unsubscribed
<b>Description</b>	BDS table is unsubscribed.
<b>Log Module</b>	validation
<b>Log Group</b>	general
<b>Severity</b>	debug

<b>Recommended Action</b>	Contact Rtbrick customer support
---------------------------	----------------------------------

<b>Log ID</b>	VALIDATION_TRAP_ADDED
<b>Message</b>	Trap %s added
<b>Description</b>	Validation trap is added.
<b>Log Module</b>	validation
<b>Log Group</b>	config
<b>Severity</b>	debug
<b>Recommended Action</b>	Contact Rtbrick customer support

<b>Log ID</b>	VALIDATION_TRAP_DELETED
<b>Message</b>	Trap %s deleted
<b>Description</b>	Validation trap is deleted.
<b>Log Module</b>	validation
<b>Log Group</b>	config
<b>Severity</b>	debug
<b>Recommended Action</b>	Contact Rtbrick customer support

<b>Log ID</b>	VALIDATION_OBJ_GET_FAILED
<b>Message</b>	Failed to get object for table %s
<b>Description</b>	BDS object failure.
<b>Log Module</b>	validation
<b>Log Group</b>	general
<b>Severity</b>	debug
<b>Recommended Action</b>	Contact Rtbrick customer support

<b>Log ID</b>	VALIDATION_OBJ_ADD_FAILED
<b>Message</b>	Failed to add object for table %s

<b>Description</b>	BDS object add failure.
<b>Log Module</b>	validation
<b>Log Group</b>	general
<b>Severity</b>	debug
<b>Recommended Action</b>	Contact Rtbrick customer support

<b>Log ID</b>	VALIDATION_OBJ_DEL_FAILED
<b>Message</b>	Failed to delete object for table %s
<b>Description</b>	BDS object deletion failure.
<b>Log Module</b>	validation
<b>Log Group</b>	general
<b>Severity</b>	debug
<b>Recommended Action</b>	Contact Rtbrick customer support

<b>Log ID</b>	VALIDATION_CACHE_ADDED
<b>Message</b>	Cache object added in instance %s with cache-ip %s src-ip %s
<b>Description</b>	Cache object has been added.
<b>Log Module</b>	validation
<b>Log Group</b>	general
<b>Severity</b>	debug
<b>Recommended Action</b>	Contact Rtbrick customer support

<b>Log ID</b>	VALIDATION_CACHE_DELETED
<b>Message</b>	Cache object deleted from instance %s with cache-ip %s src-ip %s
<b>Description</b>	Cache object has been deleted.
<b>Log Module</b>	validation
<b>Log Group</b>	general

<b>Severity</b>	debug
<b>Recommended Action</b>	Contact Rtbrick customer support

<b>Log ID</b>	VALIDATION_CACHE_ADD_FAILED
<b>Message</b>	Failed to add cache object in instance %s with cache-ip %s src-ip %s
<b>Description</b>	Cache object add failure.
<b>Log Module</b>	validation
<b>Log Group</b>	general
<b>Severity</b>	debug
<b>Recommended Action</b>	Contact Rtbrick customer support

<b>Log ID</b>	VALIDATION_CACHE_DEL_FAILED
<b>Message</b>	Failed to delete cache object from instance %s with cache-ip %s src-ip %s
<b>Description</b>	Cache object delete failure.
<b>Log Module</b>	validation
<b>Log Group</b>	general
<b>Severity</b>	debug
<b>Recommended Action</b>	Contact Rtbrick customer support

<b>Log ID</b>	VALIDATION_CACHE_CHANGED
<b>Message</b>	Cache object changed in instance %s with cache-ip %s src-ip %s
<b>Description</b>	Cache object has been changed.
<b>Log Module</b>	validation
<b>Log Group</b>	general
<b>Severity</b>	debug

<b>Recommended Action</b>	Contact Rtbrick customer support
---------------------------	----------------------------------

<b>Log ID</b>	VALIDATION_CACHE_GET_FAILED
<b>Message</b>	Failed to get cache in instance %s with cache-ip %s src-ip %s
<b>Description</b>	Cache object failure.
<b>Log Module</b>	validation
<b>Log Group</b>	general
<b>Severity</b>	debug
<b>Recommended Action</b>	Contact Rtbrick customer support

<b>Log ID</b>	VALIDATION_CACHE_STOPPED
<b>Message</b>	Cache stopped in instance %s with cache-ip %s src-ip %s
<b>Description</b>	Cache stopped.
<b>Log Module</b>	validation
<b>Log Group</b>	general
<b>Severity</b>	debug
<b>Recommended Action</b>	Contact Rtbrick customer support

<b>Log ID</b>	VALIDATION_CACHE_FLUSHED
<b>Message</b>	Cache stale object flushed in instance %s with cache-ip %s src-ip %s
<b>Description</b>	Cache stale object flushed.
<b>Log Module</b>	validation
<b>Log Group</b>	general
<b>Severity</b>	debug
<b>Recommended Action</b>	Contact Rtbrick customer support

<b>Log ID</b>	VALIDATION_CACHE_FLUSH_COUNT
---------------	------------------------------

<b>Message</b>	%s stale objects flushed in table %s
<b>Description</b>	Cache stale object flushed.
<b>Log Module</b>	validation
<b>Log Group</b>	general
<b>Severity</b>	debug
<b>Recommended Action</b>	Contact Rtbrick customer support

<b>Log ID</b>	VALIDATION_CACHE_START
<b>Message</b>	Tring to start the cache in instance %s with cache-ip %s src-ip %s
<b>Description</b>	Cache start.
<b>Log Module</b>	validation
<b>Log Group</b>	general
<b>Severity</b>	debug
<b>Recommended Action</b>	Contact Rtbrick customer support

<b>Log ID</b>	VALIDATION_CACHE_CONNECT
<b>Message</b>	Tring to connect to cache in instance %s with cache-ip %s src-ip %s port %s
<b>Description</b>	Cache connect.
<b>Log Module</b>	validation
<b>Log Group</b>	general
<b>Severity</b>	debug
<b>Recommended Action</b>	Contact Rtbrick customer support

<b>Log ID</b>	VALIDATION_CACHE_CONNECT_FAILED
<b>Message</b>	Connect failed to cache in instance %s with cache-ip %s src-ip %s port %s
<b>Description</b>	Cache connect failure.

<b>Log Module</b>	validation
<b>Log Group</b>	general
<b>Severity</b>	debug
<b>Recommended Action</b>	Contact Rtbrick customer support

<b>Log ID</b>	VALIDATION_PKT_ERROR
<b>Message</b>	Error while processing pdu %s from cache in instance %s with cache-ip %s src-ip %s
<b>Description</b>	Cache packet error.
<b>Log Module</b>	validation
<b>Log Group</b>	general
<b>Severity</b>	debug
<b>Recommended Action</b>	Contact Rtbrick customer support

<b>Log ID</b>	VALIDATION_PKT_ERROR_SEND
<b>Message</b>	Sending error %s %s to cache in instance %s with cache-ip %s src-ip %s
<b>Description</b>	Cache packet error.
<b>Log Module</b>	validation
<b>Log Group</b>	general
<b>Severity</b>	debug
<b>Recommended Action</b>	Contact Rtbrick customer support

<b>Log ID</b>	VALIDATION_PKT_ERROR_CACHE_NOT_FOUND
<b>Message</b>	Failed to get cache during pkt processing in instance %s with cache-ip %s src-ip %s
<b>Description</b>	Cache object not found.
<b>Log Module</b>	validation
<b>Log Group</b>	general

<b>Severity</b>	debug
<b>Recommended Action</b>	Contact Rtbrick customer support

<b>Log ID</b>	VALIDATION_FSM_TIMER_STARTED
<b>Message</b>	Timer %s started for cache in instance %s with cache-ip %s src-ip %s
<b>Description</b>	Cache FSM timer started.
<b>Log Module</b>	validation
<b>Log Group</b>	general
<b>Severity</b>	debug
<b>Recommended Action</b>	Contact Rtbrick customer support

<b>Log ID</b>	VALIDATION_FSM_TIMER_STOPPED
<b>Message</b>	Timer %s stopped for cache in instance %s with cache-ip %s src-ip %s
<b>Description</b>	Cache FSM timer stopped.
<b>Log Module</b>	validation
<b>Log Group</b>	general
<b>Severity</b>	debug
<b>Recommended Action</b>	Contact Rtbrick customer support

<b>Log ID</b>	VALIDATION_FSM_TIMER_EXPIRED
<b>Message</b>	Timer %s expired for cache in instance %s with cache-ip %s src-ip %s
<b>Description</b>	Cache FSM timer expired.
<b>Log Module</b>	validation
<b>Log Group</b>	general
<b>Severity</b>	debug



<b>Recommended Action</b>	Contact Rtbrick customer support
---------------------------	----------------------------------

<b>Log ID</b>	VALIDATION_FSM_EVENT
<b>Message</b>	cache [%s cache-ip %s src-ip %s] moved from %s to %s with event %s
<b>Description</b>	Cache FSM timer expired.
<b>Log Module</b>	validation
<b>Log Group</b>	general
<b>Severity</b>	debug
<b>Recommended Action</b>	Contact Rtbrick customer support

<b>Log ID</b>	VALIDATION_LWIP_EVENT
<b>Message</b>	Event %s for cache [%s cache-ip %s src-ip %s]
<b>Description</b>	Cache LWIP event.
<b>Log Module</b>	validation
<b>Log Group</b>	general
<b>Severity</b>	debug
<b>Recommended Action</b>	Contact Rtbrick customer support

## 17.3. LED Control

### 17.3.1. LED Overview

You can use the switch LEDs to monitor the activity and performance of a network switch or router. Using the LED control functionality, you can control the LEDs that are available in the hardware platforms supported by RBFS.

There are two types of LEDs available in the switch:

- Network Port LEDs
- System LEDs

## Supported Platforms

Not all features are necessarily supported on each hardware platform. Refer to the *Platform Guide* for the features and the sub-features that are or are not supported by each platform.

### 17.3.2. LED Definitions

#### Port LED Definition for UfiSpace S9500-22XST

The network port LEDs are used to show the status of the link associated with the LED. In a UfiSpace S9500-22XST switch, there are 12\*10G SFP+ ports, 8\*25G SFP28 ports, and 2\*100G QSFP28 ports on the front panel. The SFP, SFP28, and QSFP28 ports operate in a full duplex mode when the speed is 10Gbps, 25Gbps, or 100Gbps.

LED	Condition	Status
SFP+ Port LED	On (Green)	Link is up
	Off	No link
SFP28 Port LED	On (Green)	Link is up
	Off	No link
QSFP28 Port LED	On (Green)	Link is up
	Off	No link

#### System LED Definition for UfiSpace S9500-22XST

The system LEDs are used to indicate the status of power and system.

LED Indicators	Condition	Status
Power	Off	No power or in shut down mode.
	Solid Green	System power is good and the BMC heating is complete.
	Blinking Green	System power is good and the BMC heating is in progress.
	Solid Yellow	System power is good but BMC heating is failed.
	Blinking Yellow	System power failure.
STAT (System Status)	Off	System (X86 and BMC) is no booted.
	Solid Green	System boot is complete.
	Blinking Green	System boot is in progress.
	Solid Yellow	Reserved
	Blinking Yellow	Reserved
PSU LED Functions and State	Off	No DC power to any of the PSUs.
	Flashing Red	No DC power to this particular PSU.
	Flashing Green	DC is present, only standby output is on. Poor contact.
	Green	PSU DC output is on and is normal.
	Red	PSU failure.
	Flashing between Green and Red	Warning. Working condition is not satisfied. Check the voltage, electric current, and temperature.

LED Indicators	Condition	Status
FAN LED Functions and State	Off	Main board 3.3V power is failed or fan is not present.
	Solid Green	Fan is present and interrupt de-assert.
	Blinking Green	NA
	Solid Yellow	NA
	Blinking Yellow	Fan is present but interrupt assert.

### Port LED Definition for UfiSpace S9600-32X

The network port LEDs are used to show the status of the link associated with the LED. In a UfiSpace S9600-32X switch, there are 4\*10G SFP+ ports and 32\*100G QSFP28 ports on the front panel. The SFP+ and QSFP28 ports operate in full duplex mode when the speed is 10Gbps and 100Gbps respectively.

LED	Condition	Status
SFP+ Port LED	On (Green)	Link is up
	Off	No link
QSFP28 Port LED	On (Green)	Link is up
	Off	No link

### System LED Definition for UfiSpace S9600-32X

The system LEDs are used to indicate the status of power and system.

<b>LED</b>	<b>Condition</b>	<b>Status</b>
SYS	Off	System (x86 and BMC) is not booted.
	Solid Green	System boot is complete.
	Blinking Green	System boot is in progress.
	Fast Blinking Green	Reserved.
	Solid Amber	Power is up but system boot is failed.
	Blinking Amber	Reserved
	Fast Blinking Amber	Reserved
FAN	Off	Main board 3.3V_FAN power failure or no power.
	Solid Green	All fans are working normally and interrupt de-assert.
	Blinking Green	Fans PWMs do not match or each one fan no present
	Fast Blinking Green	Reserved.
	Solid Amber	Each one of fans is failure (PWM=0)
	Blinking Amber	Fan is present but interrupt assert.
	Fast Blinking Amber	Reserved

<b>LED</b>	<b>Condition</b>	<b>Status</b>
PSU1	Off	No DC power or standby is failed.
	Solid Green	PSU DC output is ON and standby is normal.
	Blinking Green	No PSU is present.
	Fast Blinking Green	Reserved.
	Solid Amber	PSU DC output is failed and standby is normal.
	Blinking Amber	Warning. Working condition is not satisfied. (Check the voltage, electric current, and temperature).
	Fast Blinking Amber	Reserved
PSU2	Off	No DC power or standby is failed.
	Solid Green	PSU DC output is ON and standby is normal.
	Blinking Green	No PSU is present.
	Fast Blinking Green	Reserved.
	Solid Amber	PSU DC output is failed and standby is normal.
	Blinking Amber	Warning. Working condition is not satisfied. (Check the voltage, electric current, and temperature).
	Fast Blinking Amber	Reserved

LED	Condition	Status
ID	Off	Turned off location of function
	Solid Blue	Ready for location of function
	Blinking Blue	Location of switch in telcom center
	Fast Blinking Blue	Reserved.

## Port LED Definition for UfiSpace S9600-72XC

The network port LEDs are used to show the status of the link associated with the LED. In an UfiSpace S9600-72XC switch, there are 64\*25G SFP28 ports and 8\*100G QSFP28 on the front panel. SFP28 and QSFP28 operate in full duplex mode when the speed is 25Gbps and 100Gbps respectively.

LED	Condition	Status
SFP28 Port LED	On (Green)	Link is up
	Off	No link
QSFP28 Port LED	On (Green)	Link is up
	Off	No link

## System LED Definition for UfiSpace S9600-72XC

The system LEDs are used to indicate the status of power and system.

LED	Condition	Status
SYS	Off	No power
	Solid Green	Host CPU/BMC boot is complete
	Solid Amber	Power is up, but host CPU/BMC boot is failed.
FAN	Off	Fans are not initialized.
	Solid Green	All fans are working normally.
	Blinking Amber	Fan is not working. One or more fans need service.

<b>LED</b>	<b>Condition</b>	<b>Status</b>
PSU1	Off	No power
	Solid Green	PSU1 is working normally.
	Blinking Amber	PSU1 is failed. Service required.
PSU2	Off	No power
	Solid Green	PSU2 is working normally.
	Blinking Amber	PSU2 is failed. Service is needed.

### **Port LED Definition for UfiSpace S9510-28DC**

The network port LEDs are used to represent the status of the link associated with the LED.

<b>Port type</b>	<b>Condition</b>	<b>Status</b>
SFP+	Up	Green
	Down	Off
SFP28	Up	Green
	Down	Off
QSFP28	Up	Green
	Down	Off

### **System LED Definition for UfiSpace S9510-28DC**

The system LEDs are used to indicate the status of power and system.



<b>LED Indicators</b>	<b>Behavior</b>	<b>Status</b>
Power	Off	No power or in shut down mode.
	Solid Green	System power is good.
	Blinking Green	System power is good but BMC power is failed.
	Solid Yellow	System power is good but CPU power is failed.
	Blinking Yellow	System power failure.
STAT (System Status)	Off	System (X86 and BMC) is not booted.
	Solid Green	System boot is complete.
	Blinking Green	System boot is in progress.
	Solid Yellow	System boot is complete. (DIAG OS)
	Blinking Yellow	Reserved
PSU LED Functions and State	Off	No DC power to any of the PSUs.
	Flashing Red	No DC power to this particular PSU.
	Flashing Green	DC is present, only standby output is on. Poor contact.
	Green	PSU output is on and normal.
	Red	PSU failure.
	Flashing between Green and Red	Warning. Working condition is not satisfied. Check the voltage, electric current, and temperature.

LED Indicators	Behavior	Status
FAN LED Functions and State	Off	Main board 3.3V power is failed or fan is not present.
	Solid Green	Fan is present but interrupt assert
	Blinking Green	NA
	Solid Yellow	NA
	Blinking Yellow	Fan is present but interrupt assert.

### Port LED Definition for EdgeCore AGR130

The network port LEDs are used to represent the status of the link associated with the LED. In an Accton/EdgeCore AGR130 switch, there are 48\*10G SFP+ ports and 6\*100G QSFP28 on the front panel, the all SFP/QSFP28 will operate in full duplex mode when the speed is 10Gbps or 100Gbps.

LED	Condition	Status
SFP+ Port LED	On/Flashing Green	Link at 10G, flashing indicates activity
	On/Flashing Amber	Link at 1G, flashing indicates activity
	Off	No link
QSFP28 Port LED in 100G Mode (Port 49 - 54)	On/Flashing Green	Link at 100G, flashing indicates activity
	Off	No link
QSFP28 Port LED in 25G Breakout Mode	On/Flashing Amber	Link at 25G in breakout mode, flashing indicates activity
	Off	No link
QSFP28 Port LED in 40G Mode (Port 49 - 54)	On/Flashing Blue	Link at 40G mode, flashing indicates activity
	Off	No link

LED	Condition	Status
QSFP28 Port LED in 10G Breakout Mode	On/Flashing Purple	Link at 10G in breakout mode, flashing indicates activity
	Off	No link

### System LED Definition for Edgecore AGR130

The system LEDs are used to indicate the status of power and system.

LED	Condition	Status
PSU1 (Power Supply Status)	Green	Power is operating normally
	Amber	Power supply is present but not powered on or faulty.
	Off	Power supply is not present.
PSU2 (Power Supply Status)	Green	Power is operating normally
	Amber	Power supply is present but not powered on or faulty.
	Off	Power supply is not present.
Diag (Diagnostic)	Green	System self-diagnostic test is successfully completed.
	Amber	System self-diagnostic test detected a fault.
FAN	Green	System FAN is operating normally
	Amber	Fan tray is present buy system FAN is faulty.
	Off	System is off

### Port LED Definition for EdgeCore AGR420

The network port LEDs are used to represent the status of the link associated with the LED.

Port type	Condition	Status
SFP+	Up	Blue LED is on (2 LEDs per port)
	Down	Off
SFP28	Up	Blue LED is on (2 LEDs per port)
	Down	Off
QSFP28	Up	Blue LED is on (2 LEDs per port)
	Down	Off

### System LED Definition for Edgecore AGR420

The system LEDs are used to indicate the status of power and system.

LED	Condition	Status
DIAG (Diagnostic)	Green	System self diagnostic test is successfully completed.
	Amber	System self-diagnostic test has detected a fault. (Faulty Fan, thermal, or any interface.)
LOC	Flashing Amber	Flashing by remote management command. Assists technician in finding the right device for service in the rack.
	Off	Not the switch that technician needs to find.
FAN	Green	System fan is working normally.
	Amber	Fan tray is present but system fan is faulty.
	Off	System is off.
PSU0 (power supply status)	Green	The power supply, #0, is working normally.
	Amber	Power is present, but not ON. Power is faulty.
	Off	Power supply is not present.

LED	Condition	Status
PSU1 (power supply status)	Green	The power supply, #1, is working normally.
	Amber	Power is present, but not ON. Power is faulty.
	Off	Power supply is not present.

## Port LED Definition for Edgecore AGR400

The network port LEDs are used to represent the status of the link associated with the LED.

Port type	Condition	Status
SFP28	Up	Blue LED is on (Single LED per port)
	Down	LED is Off
QSFP28	Up	Blue LED is on (2 LEDs per port)
	Down	LED is Off
QSFP-DD	Up	Not tested
	Down	Not tested

## System LED Definition for Edgecore AGR400

The system LEDs are used to indicate the status of power and system.

LED	Condition	Status
DIAG (Diagnostic)	Green	System self diagnostic test is successfully completed.
	Amber	System self-diagnostic test has detected a fault. (Faulty Fan, thermal, or any interface.)

<b>LED</b>	<b>Condition</b>	<b>Status</b>
LOC	Flashing Amber	Flashing by remote management command. Assists the technician in finding the right device for service in the rack.
	Off	Not the switch that the technician needs to find.
FAN	Green	System fan is working normally.
	Amber	Fan tray is present but system fan is faulty.
	Off	System is off.
PSU0 (power supply status)	Green	The power supply, #0, is working normally.
	Amber	Power is present, but not ON. Power is faulty.
	Off	Power supply is not present.
PSU1 (power supply status)	Green	The power supply, #1, is working normally.
	Amber	Power is present, but not ON. Power is faulty.
	Off	Power supply is not present.

## Port LED Definition for Edgecore CSR320

The network port LEDs are used to represent the status of the link associated with the LED.

<b>Port type</b>	<b>Condition</b>	<b>Status</b>
SFP+	Up	Green LED is on
	Down	LED is Off
SFP28	Up	Green LED is on
	Down	LED is Off

Port type	Condition	Status
QSFP28	Up	Green LED is on
	Down	LED is off

## System LED Definition for Edgecore CSR320

The system LEDs are used to indicate the status of power and system.

Port type	Condition	Status
PSU0 (power supply status)	Green	The power supply, #0, is working normally.
	Amber	Power is present, but not ON. Power supply is faulty.
	Off	Power supply is not present.
PSU1 (power supply status)	Green	The power supply, #1, is working normally.
	Amber	Power is present, but not ON. Power supply is faulty.
	Off	Power supply is not present.
DIAG (Diagnostic)	Green	System self diagnostic test is successfully completed.
	Blinking Green	System self-diagnostic test is in progress
	Amber	System self-diagnostic test has detected a fault.
FAN	Green	System fan is working normally.
	Blinking Green	System FAN tray is powered off when ambient temperature is less than 10 degree C.
	Amber	Fan tray is present but faulty.

Port type	Condition	Status
LOC	Flashing Amber	Flashing by remote management command. Assists the technician in finding the right device for service in the rack.
	Off	Not the switch that the technician needs to find.

### Port LED Definition for Delta AGCVA48S

The network port LEDs are used to show the status of the link associated with the LED. In the Delta’s AGCVA48S switch, there are 4\*10G SFP+ ports and 48\*25G SFP28 ports, and 10\*100G QSFP28 ports on the front panel. The SFP+, SFP28, and QSFP28 ports operate in full duplex mode even when the speed is 10Gbps, 25Gbps and 100Gbps respectively.

Port type	Condition	Status
SFP+ Port LED	On (Green)	Link is up
	Off	No link
SFP28 Port LED	On (Green)	Link is up
	Off	No link
QSFP28 Port LED	On (Green)	Link is up
	Off	No link

### Port LED Definition for Edgecore CSR440

The network port LEDs are used to represent the status of the link associated with the LED.

Port type	Condition	Status
10G	Up	Green
	Down	LED is Off
25G	Up	Blue
	Down	LED is Off



Port type	Condition	Status
100G	Up	Two LEDs per port. Green (on QSFP28) and Violet (on QSFP-DD).
	Down	LED is off

## System LED Definition for Edgecore CSR440

The system LEDs are used to indicate the status of power and system.

Port type	Condition	Status
PSU1 (power supply unit)	Solid Green	PSU1 is operating normally.
	Solid Amber	Input power is present, but the PSU1 is not ON or is in a faulty state.
	Off	The input power is not present or PSU1 is not present.
PSU2 (power supply unit)	Solid Green	PSU2 is operating normally.
	Solid Amber	Input power is present, but the PSU2 is not ON or is in a faulty state.
	Off	Input power is not present or PSU2 is not present.
DIAG (Diagnostic)	Solid Green	System self diagnostic test is successfully completed.
	Blinking Green	System self-diagnostic test is in progress.
	Solid Orange	System self-diagnostic test has detected a fault.
FAN	Solid Green	All fan modules are present and working normally.
	Solid Orange	Fan module is present but a fault has been detected.
	Off	Fan module is not present.

Port type	Condition	Status
LOC	Blinking Blue	Flashing by remote management command. It helps technicians in finding the right device for service in the rack. It provides an indication of the location of the device.
	Off	No indication.
ALARM	Solid Green	No alarms detected.
	Solid Red	Local alarm is detected.

## 17.4. IPMI

### 17.4.1. IPMI Overview

The IPMI (Intelligent Platform Management Interface) is an open-standard hardware management interface that allows you communicate with BMC (Baseboard Management Controller) of the platform hardware.

BMC, a dedicated micro-controller, manages the interface between system-management software and platform hardware. BMC performs operations such as remote power on or power off, or makes the console accessible. BMC also monitors the hardware resources such as sensors and can send alert messages over the LAN indicating a potential failure of the system.

IPMI is a way to manage the platform hardware by interacting with the hardware directly rather than with the operating system. The advantages of using IPMI are that it allows an out-of-band platform hardware management and the operating system is not burdened with the operational overheads by sending system status data.

### Supported Platforms

Not all features are necessarily supported on each hardware platform. Refer to the *Platform Guide* for the features and the sub-features that are or are not supported by each platform.

## 17.4.2. IPMI Configuration

### Configuration Syntax and Commands

The following sections describe the IPMI configuration syntax and commands.

#### IPMI Interface Configuration

This configuration allows you to communicate with the BMC on the platform hardware.

#### Syntax:

**set system platform-management ipmi interface** <interface-id> <attribute> <value>

Attribute	Description
interface <interface-id>	IPMI channel ID. For UfiSpace switches, the LAN interface ID is 1.
type <lan>	type of network
mode <dhcp   static>	Manually set the static IPv4 address or configure DHCP to receive dynamic IPv4 address.
address-family ipv4 prefix4 <prefix4>	IPv4 prefix
address-family ipv4 gateway-address <gateway-address>	IPv4 address for gateway

#### Example: IPMI Interface Configuration

```
{
  "ietf-restconf:data": {
    "rtbrick-config:system": {
      "platform-management": {
        "ipmi": {
          "interface": [
            {
              "id": 1,
              "type": "lan",
              "mode": "static",
              "address-family": {
                "ipv4": {
                  "prefix4": "198.51.100.110/24",

```

```

        "gateway-address": "198.51.100.111"
      }
    }
  ]
}

```

### IPMI User Configuration

This configuration allows you to change the password of one of the 10 users, including the admin user.

#### Syntax:

**set system platform-management ipmi user** <user-id> <options>

Attribute	Description
user <user-id>	User ID. The <b>ipmi user id</b> of the default 'admin' user on UfiSpace switches is 2.
password-plain-text <password-plain-text>	Plain text password
password-encrypted-text <password-encrypted-text>	Encrypted password

#### Example: IPMI User Configuration

```

{
  "ietf-restconf:data": {
    "rtbrick-config:system": {
      "platform-management": {
        "ipmi": {
          "user": [
            {
              "id": 2,
              "password-encrypted-text": "$21e4946e31b406de98b3077aef03ed5a7"
            }
          ]
        }
      }
    }
  }
}

```

## 17.4.3. IPMI Operational Commands

### IPMI Validation Commands

The IPMI validation commands provide you the IPMI configuration, channel, and user information. Configure the server that connects to the hardware platform. Use the IPMI tool to verify the remote accessibility by the running the following commands on the Linux shell.

Verification of remote access can be performed using the following command:

```
ipmitool -I lanplus -H <ip address> -U admin -P admin lan print 1
```

Example for remote access verification

```
supervisor@srv10-tst:~$ ipmitool -I lanplus -H 198.51.100.100 -U admin -P admin
lan print 1
Set in Progress           : Set Complete
Auth Type Support         :
Auth Type Enable          : Callback : MD5
                          : User       : MD5
                          : Operator : MD5
                          : Admin    : MD5
                          : OEM      : MD5
IP Address Source         : Static Address
IP Address                 : 198.51.100.100
Subnet Mask                : 255.255.255.128
MAC Address                : e8:c5:7a:8f:78:0d
SNMP Community String     : AMI
IP Header                  : TTL=0x40 Flags=0x40 Precedence=0x00 TOS=0x10
BMC ARP Control           : ARP Responses Enabled, Gratuitous ARP Disabled
Gratuitous ARP Intrvl     : 0.0 seconds
Default Gateway IP        : 198.51.100.41
Default Gateway MAC       : 00:00:5e:00:01:01
Backup Gateway IP         : 198.51.100.10
Backup Gateway MAC        : 00:00:00:00:00:00
802.1q VLAN ID           : Disabled
802.1q VLAN Priority      : 0
RMCP+ Cipher Suites       : 0,1,2,3,6,7,8,11,12,15,16,17
Cipher Suite Priv Max     : caaaaaaaaaaXXX
                          : X=Cipher Suite Unused
                          : c=CALLBACK
                          : u=USER
                          : o=OPERATOR
                          : a=ADMIN
                          : O=OEM
Bad Password Threshold    : 0
Invalid password disable : no
Attempt Count Reset Int. : 0
User Lockout Interval    : 0
```

Use the following command to verify the channel information:

## sudo ipmitool channel info 1

### Example for channel information

```

supervisor@onl>ufi06.q2c.u25.r4.nbg.rtbbrick.net:~ $ sudo ipmitool channel info 1
Channel 0x1 info:
  Channel Medium Type      : 802.3 LAN
  Channel Protocol Type   : IPMB-1.0
  Session Support         : multi-session
  Active Session Count    : 0
  Protocol Vendor ID     : 7154
  Volatile(active) Settings
    Alerting               : enabled
    Per-message Auth      : disabled
    User Level Auth       : enabled
    Access Mode           : always available
  Non-Volatile Settings
    Alerting               : enabled
    Per-message Auth      : disabled
    User Level Auth       : enabled
    Access Mode           : always available

```

Use the following command to verify a specific channel information:

## sudo ipmitool lan print 1

### Example for specific channel information

```

supervisor@onl>ufi06.q2c.u25.r4.nbg.rtbbrick.net:~ $ sudo ipmitool lan print 1
Set in Progress          : Set Complete
Auth Type Support       :
Auth Type Enable        : Callback : MD5
                        : User      : MD5
                        : Operator : MD5
                        : Admin    : MD5
                        : OEM      : MD5
IP Address Source       : Static Address
IP Address              : 198.51.100.100
Subnet Mask             : 255.255.255.128
MAC Address             : e8:c5:7a:8f:78:0d
SNMP Community String   : AMI
IP Header               : TTL=0x40 Flags=0x40 Precedence=0x00 TOS=0x10
BMC ARP Control         : ARP Responses Enabled, Gratuitous ARP Disabled
Gratituous ARP Intrvl  : 0.0 seconds
Default Gateway IP      : 198.51.100.41
Default Gateway MAC     : 00:00:5e:00:01:01
Backup Gateway IP       : 198.51.100.10
Backup Gateway MAC      : 00:00:00:00:00:00
802.1q VLAN ID         : Disabled
802.1q VLAN Priority    : 0
RMCP+ Cipher Suites    : 0,1,2,3,6,7,8,11,12,15,16,17
Cipher Suite Priv Max   : caaaaaaaaaaXXX
                        : X=Cipher Suite Unused
                        : c=CALLBACK
                        : u=USER

```

```

: o=OPERATOR
: a=ADMIN
: O=OEM
Bad Password Threshold : 0
Invalid password disable: no
Attempt Count Reset Int.: 0
User Lockout Interval : 0

```

Use the following command to verify the user for a channel:

```
sudo ipmitool user list 1
```

Example for user per channel

```

supervisor@onl>ufi06.q2c.u25.r4.nbg.rtbrick.net:~ $ sudo ipmitool user list 1
ID Name      Callin Link Auth IPMI Msg Channel Priv Limit
1
2 admin      false false true ADMINISTRATOR
3 true       false false false NO ACCESS
4 true       false false false NO ACCESS
5 true       false false false NO ACCESS
6 true       false false false NO ACCESS
7 true       false false false NO ACCESS
8 true       false false false NO ACCESS
9 true       false false false NO ACCESS
10 true       false false false NO ACCESS

```

## 17.5. Inband Management

### 17.5.1. In-band Management Overview

RBFS is mostly deployed on an ONL host as a Linux container. The ONL host is only reachable through the out-of-band management interface. In order to use services like NTP, and TACACS, which are run on ONL, or to use services like ssh, snmpd running in LXC container, one must use an out-of-band management connection. In-band management provides a way to access these services which are running in ONL and LXC containers via physical traffic ports.

The RBFS creates a Linux kernel interface named `inband-mgmt-0` when in-band management is enabled on an instance. The loopback IPs of the in-band instance are then assigned to this Linux interface, and the routes of this instance are downloaded to the LXC container, then to ONL. Trap rules are installed in the hardware depending on the in-band service enabled.

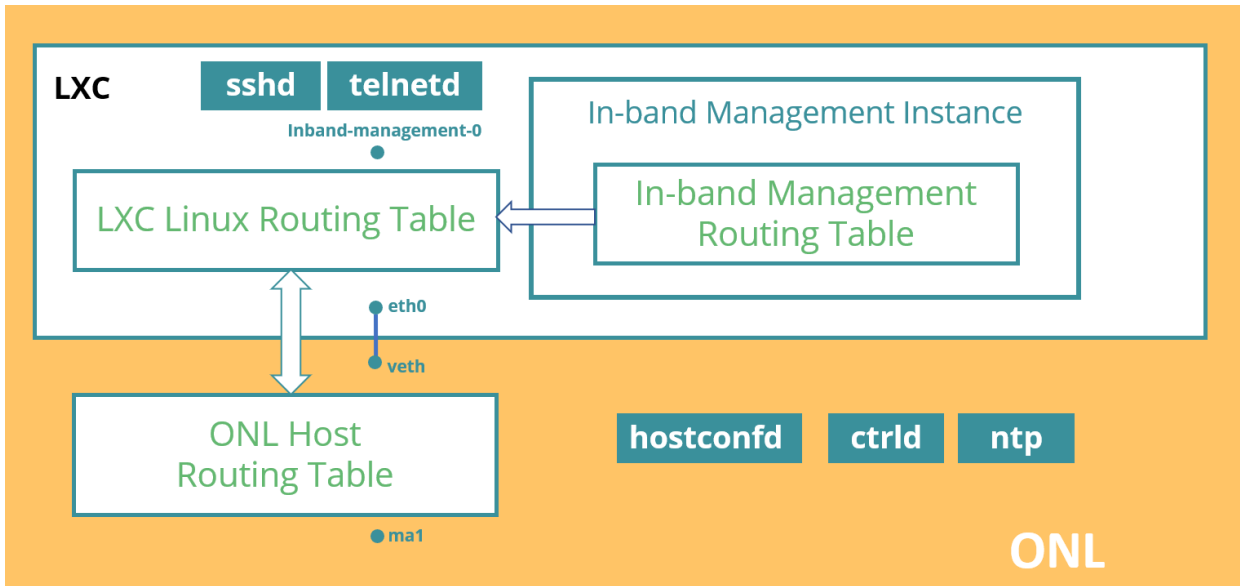

### Supported Platforms

Not all features are necessarily supported on each hardware platform. Refer to the *Platform Guide* for the features and the sub-features that are or are not supported by each platform.

## 17.5.2. In-band Management Configuration

### Enabling In-band Management in an Instance

Use the following CLI syntax to enable in-band management in an instance:

**set inband management instance** <instance-name>

Attribute	Description
<instance-name>	Routing instance name in which in-band management has to be enabled. All the IFLs in this instance will be enabled with in-band management service after executing this command

The following example configures the `management` instance in which in-band management will be enabled:

```
set inband management instance management
```

The following example shows in-band management in an instance:



```
"rtbrick-config:inband-management": {
  "instance": [
    {
      "name": "management",
    }
  ]
}
```

## Enabling In-band Management Services

Syntax:

**set inband management instance** <instance-name> <service> <true/false>

Attribute	Description
<instance-name>	Routing instance name in which in-band management has to be enabled. All the IFLs in this instance will be enabled with in-band management service after executing this command
<service>	Specifies the supported services to enable: <b>apigw</b> , <b>ctrld</b> , <b>ntp</b> , <b>snmp</b> , <b>ssh</b> , <b>tacacs</b> , <b>telnet</b> . By enabling any of these services, hosts reachable via the physical interface in the inband instance can access the services.
<true   false>	A <b>true</b> value enables the service. A <b>false</b> value disables the service.

### Example: Enabling In-band Management Services

```
"rtbrick-config:inband-management": {
  "instance": [
    {
      "name": "management",
      "ssh": "true",
      "ctrld": "true"
    }
  ]
}
```

## Enabling API Gateway (APIGW) Service

To access the APIGW service running in the ONL, this service has to be enabled in in-band management.

Syntax:

**set inband management instance** <instance-name> **apigw** <true/false>

Attribute	Description
<instance-name>	Routing instance name in which in-band management has to be enabled.
<true   false>	A <b>true</b> value enables the APIGW service. A <b>false</b> value disables the APIGW service.

Example: Enabling APIGW In-band Management Services

```
"rtbrick-config:inband-management": {
  "instance": [
    {
      "name": "management",
      "apigw": "true",
    }
  ]
}
```

### Enabling CTRLD Service

To access the CTRLD service running in the ONL, the CTRLD service has to be enabled in in-band management.

Syntax:

**set inband management instance** <instance-name> **ctrlld** <true/false>

Attribute	Description
<instance-name>	Routing instance name in which in-band management has to be enabled.
<true   false>	A <b>true</b> value enables the CTRLD service. A <b>false</b> value disables the CTRLD service.

Example: Enabling CTRLD In-band Management Services

```
"rtbrick-config:inband-management": {
  "instance": [
    {
      "name": "management",
      "ctrlld": "true",
    }
  ]
}
```

```

    }
  ]
}
    
```

## Enabling NTP service

To access the NTP service running in the ONL, this service has to be enabled in in-band management.

Syntax:

**set inband management instance** <instance-name> **ntp** <true/false>

Attribute	Description
<instance-name>	Routing instance name in which in-band management has to be enabled.
<true   false>	A <b>true</b> value enables the ntp service. A <b>false</b> value disables the ntp service.

### Example: Enabling NTP In-band Management Services

```

"rtbrick-config:inband-management": {
  "instance": [
    {
      "name": "management",
      "ntp": "true",
    }
  ]
}
    
```

## Enabling SNMP service

To access the Simple Network Management Protocol (SNMP) service running in the ONL, this service has to be enabled in in-band management.

Syntax:

**set inband management instance** <instance-name> **snmp** <true/false>

Attribute	Description
<instance-name>	routing instance name in which in-band management has to be enabled.

Attribute	Description
<true   false>	A <b>true</b> value enables the SNMP service. A <b>false</b> value disables the SNMP service.

### Example: Enabling SNMP In-band Management Services

```
"rtbrick-config:inband-management": {
  "instance": [
    {
      "name": "management",
      "snmp": "true",
    }
  ]
}
```

### Enabling SSH service

To access the ssh service running in the LXC container hosting RBFS, ssh service has to be enabled.

Syntax:

**set inband management instance** <instance-name> **ssh** <true/false>

Attribute	Description
<instance-name>	Routing instance name in which in-band management has to be enabled.
<true   false>	A <b>true</b> value enables the ssh service. A <b>false</b> value disables the ssh service.

### Example: Enabling SSH In-band Management Services

```
"rtbrick-config:inband-management": {
  "instance": [
    {
      "name": "management",
      "ssh": "true",
    }
  ]
}
```

## Enabling TACACS Service

To access the TACACS service running in the ONL, this service has to be enabled in in-band management.

Syntax:

**set inband management instance** <instance-name> **tacacs** <true/false>

Attribute	Description
<instance-name>	Routing instance name in which in-band management has to be enabled.
<true   false>	A <b>true</b> value enables the TACACS service. A <b>false</b> value disables the TACACS service.

Example: Enabling TACACS In-band Management Services

```
"rtbrick-config:inband-management": {
  "instance": [
    {
      "name": "management",
      "tacacs": "true",
    }
  ]
}
```

## Enabling Telnet Service

To access the telnet service running in the LXC container hosting RBFS, telnet service has to be enabled.

Syntax:

**set inband management instance** <instance-name> **telnet** <true/false>

Attribute	Description
<instance-name>	Routing instance name in which in-band management has to be enabled.
<true   false>	A <b>true</b> value enables the telnet service. A <b>false</b> value disables the telnet service.

Example: Enabling Telnet In-band Management Services

```
"rtbrick-config:inband-management": {
  "instance": [
    {
      "name": "management",
      "telnet": "true",
    }
  ]
}
```

## Enabling Connection Tracking

Enabling connection tracking in inband installs dynamic ACLs for all the connection/packet initiated by the device so that the response packets are not dropped at the hardware.

Syntax:

**set inband management instance** <instance-name> **connection-tracking true**

Attribute	Description
<instance-name>	Routing instance name in which in-band management has to be enabled.
true	Enables all in-band management services.

Example: Enabling Connection Tracking in In-band Management

```
"rtbrick-config:inband-management": {
  "instance": [
    {
      "name": "default",
      "connection-tracking": "true"
    }
  ]
}
```

## Enabling LIX1 Service

To enable or disable the "lix1" service within inband management, use the following CLI command:

**set inband management instance** <instance-name> **lix1** <true | false>

Attribute	Description
-----------	-------------

<instance-name>	Specifies the routing instance where the in-band lix1 service is to be enabled.
<true   false>	Setting this attribute to "true" enables the "lix1" service, while setting it to "false" disables the service.

Example: Enabling the "lix1" service in inband management

```
"rtbrick-config:inband-management": {
  "instance": [
    {
      "name": "default",
      "lix1": "true",
    }
  ]
}
```

## Enabling All Services in In-band Management

Enabling this service will allow access to all services running in LXC/ONL. Once this service is enabled, packets that don't hit any of the other acls/services in RBFS are redirected to LXC/ONL.

Syntax:

**set inband management instance** <instance-name> **all true**

Attribute	Description
<instance-name>	Routing instance name in which in-band management has to be enabled.
true	Enables all in-band management services.

Example: Enabling all In-band Management Services

```
"rtbrick-config:inband-management": {
  "instance": [
    {
      "name": "management",
      "all": "true",
    }
  ]
}
```

## Enabling In-band Management for a Specific Source

Enabling any of the in-band services as mentioned in the previous section will expose this service to all the sources which are reachable via in-band service.

To restrict this to specific source prefixes, source-prefix-list has to be enabled using the following command.

By configuring this, the hosts having IPs in the mentioned source prefix list only can access this service.

Syntax:

**set inband management instance** <instance-name> **source-prefix-list** <source-prefix-list-name>

Attribute	Description
<instance-name>	Routing instance name in which in-band management has to be enabled.
<source-prefix-list-name>	Specifies the name of the source prefix-list which is configured in 'set forwarding-options prefix-list' command.

Example: Enabling source prefix list in In-band Management Services

```

"rtbrick-config:inband-management": {
  "instance": [
    {
      "name": "management",
      "source-prefix-list": "source-prefix1"
    }
  ]
}

```

### 17.5.3. In-Band Management Operational Commands

The In-band Management show commands provide detailed information about the In-band Management operations.

#### Verifying In-band Management on LXC Container

In the LXC container, there will be a new interface named **inband-mgmt-0** on



enabling in-band management. All the loopback address as well as route in in-band instance should be assigned to this interface.

The example below shows how to verify if inband-mgmt-0 interface is created and if the routing for management traffic is pointing to it.

```
supervisor@rtbrick:~$ ip link show
<...>
5: inband-mgmt-0: <POINTOPOINT,UP,LOWER_UP> mtu 1492 qdisc pfifo_fast state
UNKNOWN mode DEFAULT group default qlen 500
    link/none

supervisor@rtbrick:~$ ip route show
198.51.100.1/24 dev inband-mgmt-0 proto rtb_fibd scope link
<...>
```

## Verifying In-band Management on ONL

The example below shows how to verify Linux routing tables on ONL host and LXC container.

```
root@bl2-pod1:~# ip route show
default via 198.51.100.202 dev ma1 proto rtb_routesync metric 4294966272
default via 198.51.100.10 dev lxcbr0 proto rtb_routesync scope rtb_umc metric 128
198.51.100.81/24 via 198.51.100.10 dev lxcbr0 proto rtb_routesync scope rtb_umc
metric 128
198.51.100.30/24 dev lxcbr0 proto kernel scope link src 198.51.100.31
198.51.100.55 via 198.51.100.10 dev lxcbr0 proto rtb_routesync scope rtb_umc
metric 128
198.51.100.119/23 dev ma1 proto kernel scope link src 198.51.100.112

supervisor@rtbrick:~$ ip route show
default via 198.51.100.31 dev eth0 proto rtb_routesync scope rtb_umc metric
4294966400
default dev inband-mgmt-0 proto rtb_fibd scope link
198.51.100.81/24 dev inband-mgmt-0 proto rtb_fibd scope link
198.51.100.30/24 dev eth0 proto kernel scope link src 198.51.100.10
198.51.100.55 dev inband-mgmt-0 proto rtb_fibd scope link
198.51.100.119/23 via 198.51.100.31 dev eth0 proto rtb_routesync scope rtb_umc
metric 128
198.51.100.112 via 198.51.100.31 dev eth0 proto rtb_routesync scope rtb_umc metric
128
```

## 17.6. DHCP Relay/Proxy

### 17.6.1. DHCP Relay Overview

The Dynamic Host Configuration Protocol (DHCP) is a standardized client/server

network protocol that dynamically assigns IPv4 addresses and other related configuration information to network devices.

DHCP provides an automated way to distribute and update IPv4 addresses and other configuration information on a network. A DHCP server provides this information to a DHCP client through the exchange of a series of messages, known as the DHCP conversation or the DHCP transaction. If the DHCP server and DHCP clients are located on different subnets, a DHCP relay agent is used to facilitate the conversation.

The RBFS DHCP relay agent handles all DHCP packets received on logical interfaces with the relay agent functionality enabled. This includes all DHCP broadcast and unicast packets to ensure that the whole DHCP communication between client and server can be tracked for operational and security reasons. The DHCP packets received from clients will then be forwarded to one or more DHCP servers to support high availability.

All DHCP packets sent from the relay agent to the configured DHCP servers will be sent with the IP address of the gateway interface (giaddr) or a dedicated source address per server. This allows to better traverse firewalls between relay agent and server.

## Supported Platforms

Not all features are necessarily supported on each hardware platform. Refer to the *Platform Guide* for the features and the sub-features that are or are not supported by each platform.

## DHCP Relay Agent

The following are the operation steps involved by the DHCP relay agent with multiple clients and servers:

1. DHCP client sends DISCOVER packets onto the LAN.
2. DHCP relay agent receives the DISCOVER packet, creates a client binding and forwards it to the configured server(s) in different subnets.
3. DHCP server replies with OFFER packet.
4. DHCP relay agent on receiving the OFFER, sends it to the client based on the binding.

5. DHCP client sends a REQUEST after receiving the OFFER.
6. DHCP relay agent forwards the REQUEST to the configured server(s).
7. Selected DHCP server replies to the REQUEST with an ACK.
8. DHCP relay agent receives the ACK and forward it to client.
9. Client will start using the IP and configuration after receiving the ACK.
10. DHCP relay agent listen to the unicast communication between the client and server and update the bindings.

## **DHCP Relay in Proxy Mode**

The proxy mode is an enhancement for the DHCP relay function to hide and protect the actual DHCP servers from the clients. For servers this mode is transparent but for clients it seems that the relay agent is the server and the actual servers are not visible anymore.

The following are the operation steps involved by the DHCP relay agent in proxy mode with multiple clients and servers:

1. DHCP client sends DISCOVER packets onto the LAN.
2. DHCP relay agent receives the DISCOVER packet, creates a client binding and forwards it to the configured server(s) in different subnets.
3. DHCP server replies with OFFER packet.
4. DHCP relay agent on receiving OFFERs from multiple servers, select the OFFER from the first server, replaces the server identifier with relay agent address, update the binding and sends it to the client.
5. DHCP client sends a REQUEST to relay agent address after receiving the OFFER.
6. DHCP relay agent forwards the REQUEST to the configured server(s).
7. Selected DHCP server replies to the REQUEST with an ACK.
8. DHCP relay agent receives the ACK, replaces the server identifier with relay agent address and forward it to client.
9. Client will start using the IP and configuration after receiving the ACK.
10. Client request the relay agent for the lease renewals, which relay agent will forward to the selected server.

In all the steps above, the client remains unaware of the actual DHCP server.

## 17.6.2. DHCP Relay Configuration

DHCP relay requires a pre-provisioned logical interface with at least an local or borrowed (unnumbered) IPv4 address configured which is than used a gateway IP address (giaddr) by the DHCP relay function.

There are two steps required to enable the DHCP relay functionality:

1. DHCP server configuration
2. DHCP relay configuration

### DHCP Server Configuration

This configuration defines the DHCP servers which are referenced by the actual DHCP relay configuration.

```

supervisor@rtbrick>LEAF01: cfg> set access dhcp-server <server>
<cr>
address                DHCP server address
routing-instance       Instance name from which DHCP server is reachable
source-address         Source address used for DHCP packets
    
```

The following example shows a typical DHCP server configuration.

```

{
  "rtbrick-config:access": {
    "dhcp-server": [
      {
        "server-name": "server1",
        "address": "198.51.100.101",
        "routing-instance": "default"
      }
    ]
  }
}
    
```

Attribute	Description
server	Specifies the DHCP server name.
address	Specifies the IPv4 address of the DHCP server.
routing-instance	Routing instance from which DHCP server is reachable.  <b>Default:</b> default

Attribute	Description
source-address <source-address>	Specifies the source IPv4 address to be used to reach DHCP server.  <b>Default:</b> gateway interfaces address (giaddr)

## DHCP Relay Configuration

This configuration enables the DHCP relay function on the corresponding logical interface (IFL).

```

supervisor@rtbrick>LEAF01: cfg> set access dhcp-relay <interface-name>
<cr>
agent-circuit-id      Add Agent-Circuit-Id (option 82)
agent-remote-id      Add Agent-Remote-ID (option 82)
dhcp-server          DHCP server
proxy-mode           Enable relay proxy mode
    
```

The following example shows a typical DHCP relay configuration.

```

{
  "rtbrick-config:access": {
    "dhcp-relay": [
      {
        "interface": "ifl-0/0/1/1",
        "dhcp-server": [
          "server1",
          "server2"
        ]
      }
    ]
  }
}
    
```

Attribute	Description
interface-name	Logical interface name on which client packets are expected.
dhcp-server <dhcp-server>	DHCP server name to which client packets has to be forwarded (multiple servers can be configured).
proxy-mode	Enable the relay proxy mode for this interface.
agent-circuit-id <aci>	Agent-Circuit-Id to be added in DHCP option 82.
agent-remote-id <ari>	Agent-Remote-Id to be added in DHCP option 82.

## DHCP Relay on Unnumbered Interface

DHCP Relay is supported over unnumbered interfaces. The configuration is similar to the regular DHCP relay configuration. The only change is that the logical interface will have a borrowed IP address.

The following example shows a typical DHCP relay configuration over unnumbered interface.

```
{
  "data": {
    "rtbrick-config:interface": [
      {
        "name": "ifp-0/0/1",
        "unit": [
          {
            "unit-id": 1,
            "unnumbered": {
              "interface": "lo-0/0/1/1"
            }
          }
        ]
      },
      {
        "name": "ifp-0/0/2",
        "unit": [
          {
            "unit-id": 1,
            "unnumbered": {
              "interface": "lo-0/0/1/1"
            }
          }
        ]
      },
      {
        "name": "lo-0/0/1",
        "unit": [
          {
            "unit-id": 1,
            "address": {
              "ipv4": [
                {
                  "prefix4": "198.51.100.71/24"
                }
              ]
            }
          }
        ]
      }
    ],
    "rtbrick-config:access": {
      "dhcp-relay": [
        {
          "interface": "ifl-0/0/1/1",
          "dhcp-server": [
            "server1",

```

```

        "server2"
      ]
    },
    {
      "interface": "if1-0/0/2/1",
      "dhcp-server": [
        "server1",
        "server2"
      ]
    }
  ]
}
}
}
}

```

### 17.6.3. DHCP Relay Operational Commands

#### Verify DHCP Relay Configuration

A good starting point for any troubleshooting is to get an overview about the configuration.

First check the DHCP server configuration and optionally check the reachability using additional commands like [ping](#).

```

supervisor@rtbrick>LEAF01: cfg> show config access dhcp-server
{
  "rtbrick-config:dhcp-server": [
    {
      "server-name": "server1",
      "address": "198.51.100.15",
      "source-address": "198.51.100.101",
      "routing-instance": "default"
    }
  ]
}

```

In the next step it should be verified that the DHCP relay function is enabled for the desired logical interfaces. Those interfaces must be configured with a valid local or borrowed (unnumbered) IPv4 address.

```

supervisor@rtbrick>LEAF01: cfg> show config access dhcp-relay
{
  "rtbrick-config:dhcp-relay": [
    {
      "interface": "if1-0/0/1/1",
      "dhcp-server": [
        "server1",
        "server2"
      ]
    }
  ]
}

```

```
]
}
```

## Verify DHCP Relay Packet Processing

All DHCP packets processed by RBFS will be handled by the IPoE daemon (`rtbrick-ipoed.1`) which separates between DHCP relay and subscriber packets.

The command `show dhcp statistics` gives some statistics about the DHCP packets send and received by the IPoE daemon.

```
supervisor@rtbrick>LEAF01: op> show dhcp statistics
Packets received           : 0
Decode error               : 0
Relay packets received    : 0
Relay packets sent        : 0
Relay send error          : 0
Subscriber packets received : 0
Subscriber packets sent   : 0
Subscriber send error     : 0
```

Received malformed packets will be counted here as part of the shared DHCP packet infrastructure.

Those statistics can be reset with the command `clear dhcp statistics`.

In the next step, the command `show dhcp relay statistics` provides more detailed statistics for those packets handled by the DHCP relay function.

```
supervisor@rtbrick>LEAF01: op> show dhcp relay statistics
Packet           Received      Sent
DHCP DISCOVER   : 0             0
DHCP OFFER      : 0             0
DHCP REQUEST    : 0             0
DHCP DECLINE    : 0             0
DHCP ACK        : 0             0
DHCP NAK        : 0             0
DHCP RELEASE    : 0             0
DHCP INFORM     : 0             0

Errors:

Invalid client packets received : 0
Invalid server packets received : 0
I/O errors                       : 0
Configuration errors             : 0
```

A DHCP packet is consider as invalid if correctly formed but some invalid or



unexpected values like a DHCP hop count greater than 16, messages from server without server identifier option, non-matching transaction (XID) and many more.

Those statistics can be reset with the command `clear dhcp relay statistics`.

## Verify DHCP Relay Bindings

The DHCP relay function tracks all active DHCP communications as so called bindings. The command `show dhcp relay binding` allows to verify those bindings with extensive filters to better navigate in scaled environments with thousands of bindings.

```
supervisor@rtbrick>LEAF01: op> show dhcp relay binding ?
<cr>
detail          Detailed binding information
filter          Filter DHCP relay binding
interface       Interface
```

```
supervisor@rtbrick>LEAF01: op> show dhcp relay binding filter ?
address         Client IP address
count          Count matching bindings
detail         Detailed binding information
interface       Interface
interface-regex Interface regex
mac            Hardware address
mac-regex      Hardware address regex
server         Server identifier
```

```
supervisor@rtbrick>LEAF01: op> show dhcp relay binding detail
Interface           : ifp-0/0/1/3
Hardware Address    : 02:00:00:00:00:01
Client IP Address   : 198.51.100.58
Routing Instance    : default
Proxy Mode          : enabled
Server Identifier   : 198.51.100.15
Gateway IP Address  : 198.51.100.35
Lease Time          : 120.0 sec
Lease Start         : Tue Nov 16 22:27:15 GMT +0000 2021
Lease Expires       : 66.0 sec
Last Packet Received : Tue Nov 16 22:27:15 GMT +0000 2021
Last Received Packet Type : ACK
Last Packet Sent    : Tue Nov 16 22:27:15 GMT +0000 2021
Last Sent Packet Type : ACK
```

The most extensive output is provided by selecting a particular binding using the interface and client MAC address as key.

```
supervisor@rtbrick>LEAF01: op> show dhcp relay binding interface ifp-0/0/1/3 mac 02:00:00:00:00:01
```

```

Interface           : ifp-0/0/1/3
Hardware Address    : 02:00:00:00:00:01
Client IP Address   : 198.51.100.58
Routing Instance   : default
Proxy Mode         : enabled
Server Identifier   : 198.51.100.15
Gateway IP Address  : 198.51.100.35
Lease Time         : 120.0 sec
Lease Start        : Tue Nov 16 22:31:15 GMT +0000 2021
Lease Expires      : 104.0 sec
Last Packet Received : Tue Nov 16 22:31:15 GMT +0000 2021
Last Received Packet Type : ACK
Last Packet Sent    : Tue Nov 16 22:31:15 GMT +0000 2021
Last Sent Packet Type : ACK
    
```

Statistics:

Packet	Received	Sent
DHCP DISCOVER	: 1	1
DHCP OFFER	: 1	1
DHCP REQUEST	: 36	36
DHCP DECLINE	: 0	0
DHCP ACK	: 36	36
DHCP NAK	: 0	0
DHCP RELEASE	: 0	0
DHCP INFORM	: 0	0

Errors:

```

Invalid client packets received : 0
Invalid server packets received : 0
I/O errors                       : 0
Configuration errors             : 0
    
```

This output returns additional statistics per DHCP relay binding.

The command **clear dhcp relay binding** removes either all bindings, all bindings of a corresponding interface or only one particular binding.

```

supervisor@rtbrick>LEAF01: op> clear dhcp relay binding ?
  all                Clear all DHCP relay bindings
  interface          Interface
    
```

```

supervisor@rtbrick>LEAF01: op> clear dhcp relay binding all
supervisor@rtbrick>LEAF01: op> clear dhcp relay binding interface ifp-0/0/1/3
supervisor@rtbrick>LEAF01: op> clear dhcp relay binding interface ifp-0/0/1/3 mac
02:00:00:00:00:01
    
```

Registered Address	Support	Sales
40268, Dolerita Avenue Fremont CA 94539		
+1-650-351-2251		+91 80 4850 5445
<a href="http://www.rtbrick.com">http://www.rtbrick.com</a>	<a href="mailto:support@rtbrick.com">support@rtbrick.com</a>	<a href="mailto:sales@rtbrick.com">sales@rtbrick.com</a>

©Copyright 2025 RtBrick, Inc. All rights reserved. The information contained herein is subject to change without notice. The trademarks, logos and service marks ("Marks") displayed in this documentation are the property of RtBrick in the United States and other countries. Use of the Marks are subject to RtBrick's Term of Use Policy, available at <https://www.rtbrick.com/privacy>. Use of marks belonging to other parties is for informational purposes only.